



## LZR<sup>®</sup>-FLATSCAN 3D SW

SAFETY SENSOR  
FOR AUTOMATIC SWING DOORS

User's Guide for software version SW 0100 and higher  
(refer to tracking label on product)



Visit website for  
available languages  
of this document.

## INSTALLATION TIPS

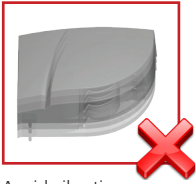

Avoid vibrations.

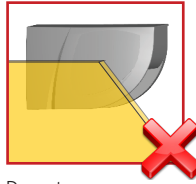

Do not cover the laser window.

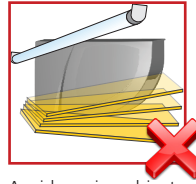

Avoid moving objects and light sources in the detection field.



Avoid the presence of smoke and fog in the detection field.



Avoid condensation.

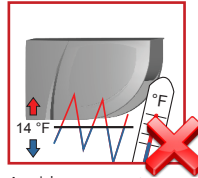

Avoid exposure to sudden and extreme temperature changes.

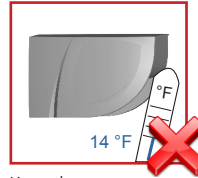

Keep the sensor permanently powered in environments where the temperature can descend below 14 °F.

## MAINTENANCE TIPS

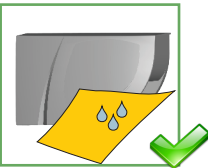

Clean the laser window with compressed air. If needed, wipe only with a soft, clean and damp microfibre cloth.



Do not use dry or dirty towels or aggressive products to clean the laser window.



Avoid direct exposure to high-pressure cleaning.

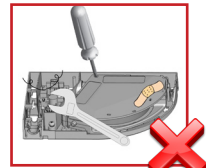

The warranty is invalid if unauthorized repairs are made or attempted by unauthorized personnel.

## SAFETY TIPS

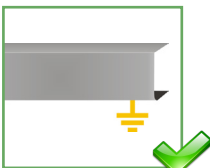

The door control unit and the header cover profile must be correctly grounded.



Only trained and qualified personnel are recommended to install and set up the sensor.



Always test for proper operation before leaving the premises.

## DESCRIPTION



The **LZR®-FLATSCAN 3D SW** is a safety sensor for automatic swing doors based on laser technology. It protects the moving door leaf as well as the pinch zone. To do so, a sensor must be installed in the upper corner of the door leaf(s).

### COVER

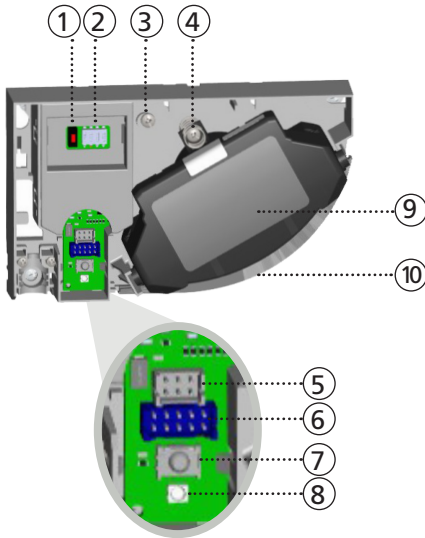

### PRIMARY-SECONDARY CABLE

35.1329

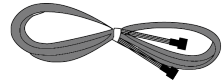

### POWER CABLE

20.5433

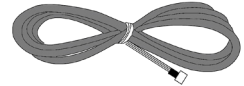

1. push button
2. DIP switch
3. lock screw
4. angle adjustment screw
5. primary-secondary connector
6. main connector
7. IR receiver
8. LED
9. laser head
10. laser window
11. plug
12. clamp
13. cap and screws (flexible kit)
14. flexible tube

### SPACER

70.5753

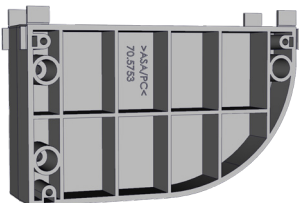

### FLEX TUBE KIT

70.0202

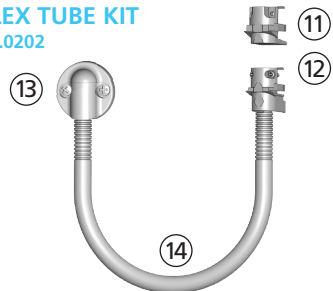

# FOREWORD

The FLATSCAN 3D SW can be paired with another FLATSCAN 3D SW or a FLATSCAN SW. The installation steps are identical for both product versions. For optimum safety and to access all features (e.g. opening functions), the FLATSCAN 3D SW must be the primary sensor.

## 1 MOUNTING ON DOOR



For applications requiring a spacer, use the provided Mounting Template (78.7001) to mount spacer to door, and then install sensor onto spacer.

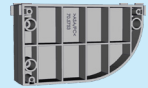

The following instructions for 1: MOUNTING ON THE DOOR are for installing a pair of sensors. If you are only installing one sensor, only use steps 1 and 4.

Note: The primary sensor is the main sensor that connects directly to the door controller, and the secondary sensor connects to the primary sensor by the pass-through cable.

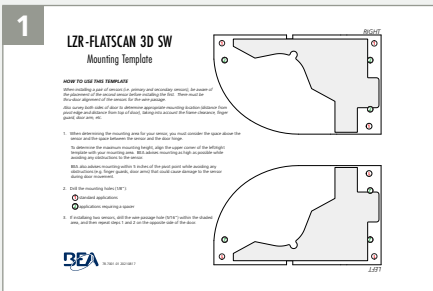

Use the LZR-FLATSCAN 3D SW Mounting Template (78.7001) to prepare the mounting location(s).

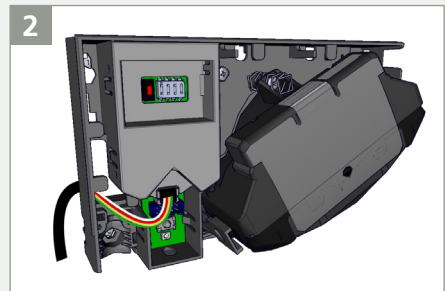

Pass the primary-secondary cable through the back side of the primary sensor, and then connect to the black connector.

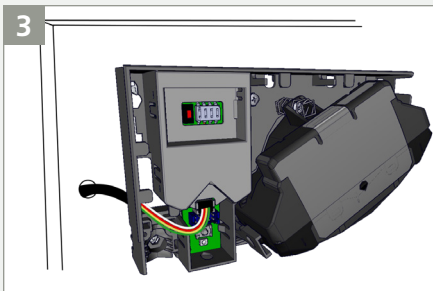

Pass the free end of the cable through the wire passage hole in the door.

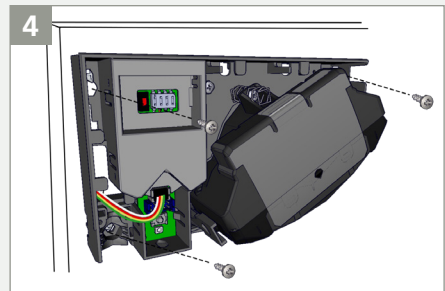

Secure the sensor to the door using the three provided screws.

# 1 MOUNTING ON DOOR (cont.)

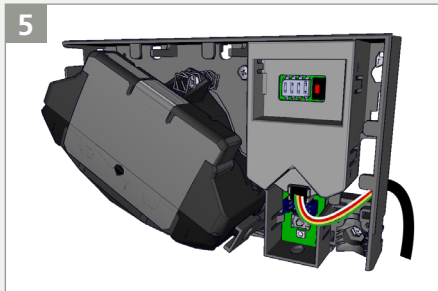

On the other side of the door, connect the primary-secondary cable to the secondary sensor in the same manner (i.e. through the back).

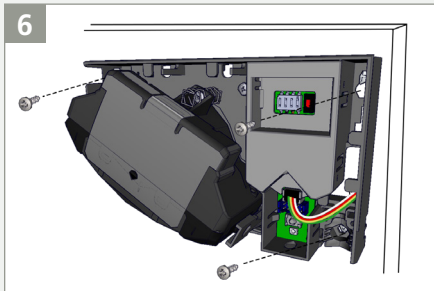

Secure the secondary sensor to the door using the three provided screws.

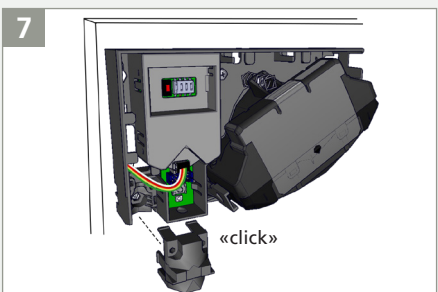

Use a plug to close the secondary sensor.

## 2 WIRING TO DOOR CONTROLLER

BEA recommends using a FLATSCAN 3D SW as the primary sensor.

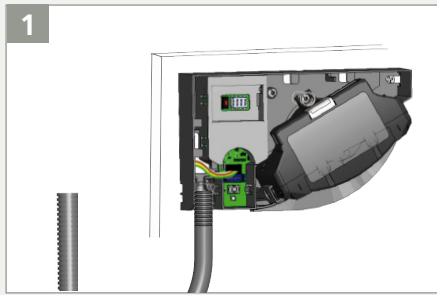

Determine the appropriate length for the door loop.

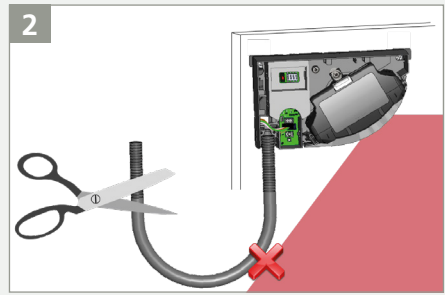

Cut the excess to avoid undesired detections caused by the flexible tube.

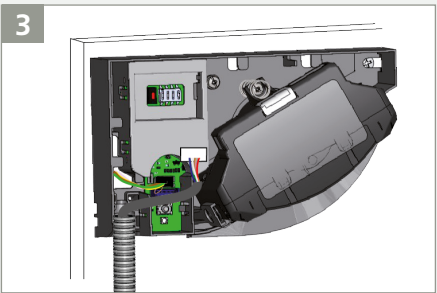

Pass the power cable through the flexible tube and connect the white plug to the white connector.

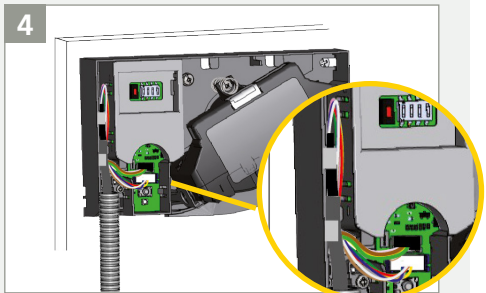

Create a loop with the wires of the power cable and pass them through the notch as indicated. Use the other part of the cable to block the wires.

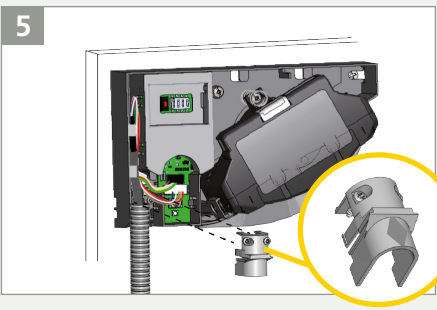

Secure the door loop to the sensor, using the clamp. Secure the 2 screws to avoid pulling out the cable.

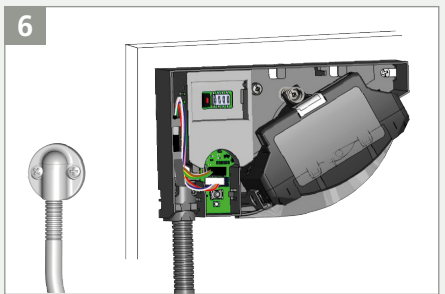

Tighten the other side of the flexible tube using the cable cap and pass through the remaining length of the power cable towards the door controller.



## 5 TEACH-IN



Before launching a teach-in, make sure that:

- **glass surfaces near the door are covered**
- when a guide rail is involved in the application, an object should be placed between the full-open door and guide rail to create a larger reference point for the learn
- the door controller is set up first
- the door is closed (use Service Mode if needed, see page 13)
- the door controller is connected to all relay outputs and is fully reacting to them
- Output Configuration is set correctly (see page 10)
- the primary-secondary cable is connected between the modules
- the detection field is free of snow buildups, heavy rain, snowfall, fog or other objects or people
- the laser window protection is removed (for FLATSCAN SW)

**NOTE:** A teach-in on the Primary configures both the Primary and the Secondary. A teach-in on the Secondary only configures the Secondary. In case the Primary and Secondary sensor are not aligned, first launch a teach-in on the Primary and then on the Secondary.

**BEA recommends setting the sensor in Service Mode before performing a teach-in (see page 13).**

1. Press the Primary sensor push-button briefly. The LED will begin quickly flashing red/green. When installing the sensor on a pair of doors, repeat this on the second Primary sensor.
2. When both sensors flash green, position yourself in front of the door(s) and stretch out your arm in front of you. Make an up-and-down motion at the leading-edge to mark the limit of the detection zones. Once the LED begins flashing red, **remove yourself from the detection zone**. The LED will continue to flash red while calculating the width of the door leaves.
3. When the sensors flash green again, **remain out of the detection field** and cycle the doors open to allow the sensors to learn the environment. The sensors will flash red during the closing of the door(s).
4. Once the door is completely closed again and the LED is off, the teach-in is complete.

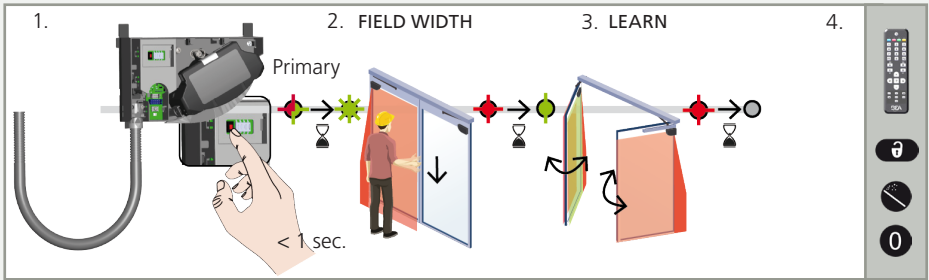

## 6 TESTING AND ADJUSTING



Check the correct positioning of the safety fields by walk-testing according to ANSI 156.10 standards.

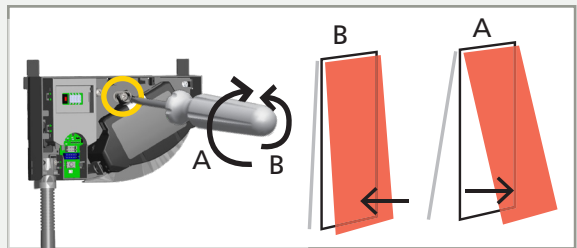

If necessary, adjust the tilt angle of the laser curtain by turning the tilt angle adjustment screw (from 0° to 5°)



After changing the angle, the sensor position or the environment, always launch a teach-in and test the correct positioning of the detection fields.

Verify that the sensor system complies with ANSI 156.10 per the AAADM walk test. Make appropriate adjustments to the sensor and/or door control, if necessary, to ensure that the system is ANSI 156.10 compliant.



## 7 VIRTUAL PUSH BUTTONS (OUTPUT 3)

Always verify compliance with ANSI 156.10, 156.19, and 156.38.

If desired and in addition to ANSI 156.10, 156.19, and 156.38 Knowing Act requirement, you can add a Virtual Push Button option (max. 2 per sensor) within the second (C2) curtain simulating the performance of a knowing-act device.

The Virtual Push Button(s) may be placed outside of the detection field but within a limit of maximum detection field range specifications. To operate, the two gray wires of the FLATSCAN 3D SW must be connected (as the primary sensor) to the activation on the door controller with the 10-wire cable provided.

1. When the green LED flashes, hold your hand in the desired position within C2 to learn the Virtual Push Button.
2. When the LED flashes red to confirm the teach-in, remove yourself and hand.
3. When the LED flashes green again, you can either learn another Virtual Push Button or wait 10 seconds for the end of the teach-in.

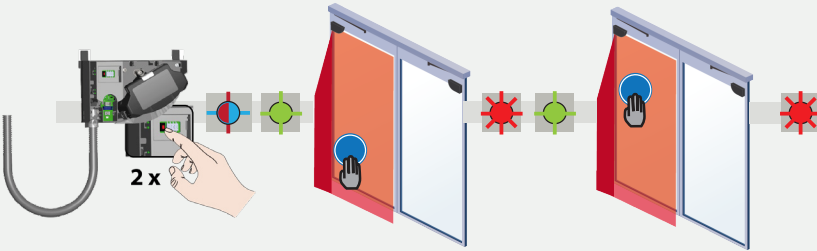

## 8 FINAL STEPS

### CLOSING

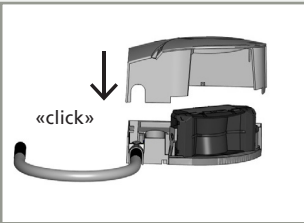

Close the cover starting on the narrow side. Do not hesitate to push.

### OPENING

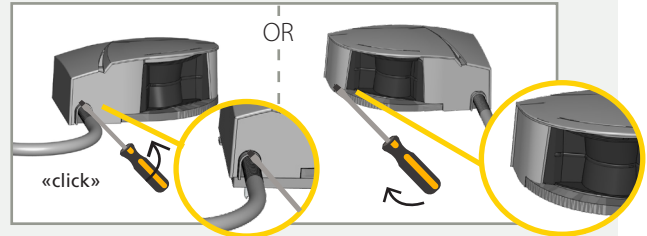

To remove the cover, position a flathead screwdriver in the notch and pull upward until the cover loosens.

## DIP SWITCH SETTINGS (OPTIONAL)

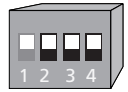

In order to adapt these parameters by remote control, set the corresponding DIP switch to ON.

	ON (switch up)	OFF (switch down)	
<b>DIP 2 ENVIRONMENT</b>	standard	critical	Switch to CRITICAL when external disturbances are likely to cause unwanted detections (min. obj size, immunity, and uncovered zone are increased).
<b>DIP 3 BACKGROUND</b>	on	off	Switch to OFF when there is no background (glass floor, pedi-mat, etc).
<b>DIP 4 PINCH ZONE</b>	on	off	Switch to OFF when the pinch zone does not need to be secured or when objects can cause unwanted detections.

**ORANGE**      **GREEN**      **OFF**

After changing a DIP switch, the orange LED flashes. A LONG push on the push button confirms the settings. Afterwards, a number of green flashes (x) indicates the number of connected modules.

## REMOTE CONTROL SETTINGS (OPTIONAL)

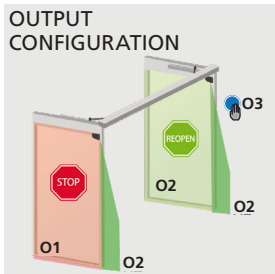

1 1 1

O1 O2 O3

- 1 NO (Normally open)
- 2 NC (Normally closed)

Always enter 3 digits for output parameters:

- 1st digit refers to Output 1 (O1) = STOP
- 2nd digit refers to Output 2 (O2) = REOPEN
- 3rd digit refers to Output 3 (O3) = VIRTUAL PUSH BUTTON

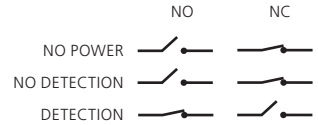

## DIMENSIONS OF ZONES

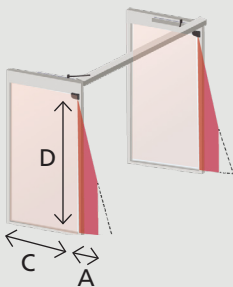

### Width of the pinch zone



### Width of the door zone



### Height of all zones



Always enter 3-digits when adjusting detection zone dimensions.

C and D: a teach-in overwrites these values automatically.

\*The actual dimensions depend on the mounting height (40 in at 13 ft).  
In order to change these settings by remote control, adjust DIP switch 4 to ON.

## REMOTE CONTROL SETTINGS (OPTIONAL)



### UNCOVERED ZONE



In order to change these settings by remote control, ensure that DIP switch 2 is set to ON

F2	1	2	3	4	5	6	7	
	¾	1 ½	2 ¾	3 ¼	4	4 ¾	5 ½	in*

Increase in case of snow, debris, etc.

\* measured in specific conditions and dependant on application and installation.

### BACKGROUND / ANTIMASKING

In order to change these settings by remote control, ensure that DIP switch 3 is set to ON

	0	1	2	3
ANTIMASKING	OFF	OFF	ON	ON
BACKGROUND	OFF	ON	OFF	ON

This is a protective function that detects an unwanted object near the laser window that is masking the vision field.

### DETECTION FIELD DEPTH

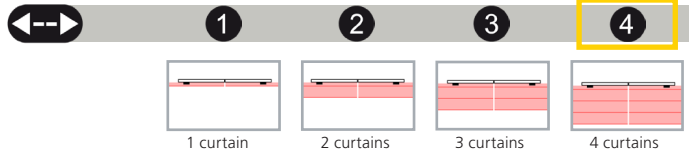

Upon door movement, the approach side sensor always extends the detection field depth to 4 curtains.

### GENERAL

	0	2	8	9
	teach-in	teach-in virtual push button	full reset	partial reset
	See page 8	See page 9	Factory reset of all values	Factory reset of all values except field dimensions and output configurations



FACTORY VALUE

## HOW TO USE THE REMOTE CONTROL



After unlocking, the red LED flashes and the sensor can be adjusted by remote control.



If the red LED flashes quickly after unlocking, you need to enter an access code from 1 to 4 digits. If you do not know the access code, **cycle the power**. During 1 minute, you can access the sensor without introducing any access code.



To end an adjustment session, always lock the sensor.

It is recommended to use a different access code for each sensor in order to avoid changing settings on both sensors at the same time.

### SAVING AN ACCESS CODE

The access code is recommended for sensors installed close to each other.



### DELETING AN ACCESS CODE



Enter the existing code

### ADJUSTING ONE OR MORE PARAMETERS

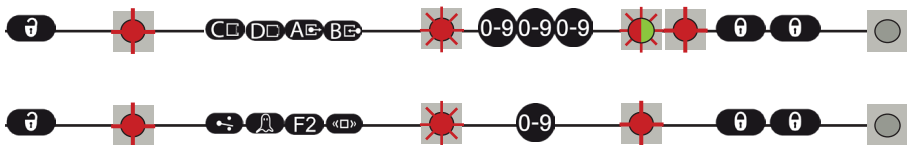

### CHECKING A VALUE

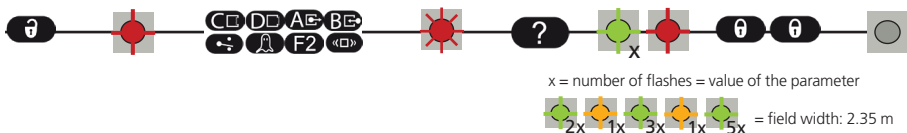

### RESTORING TO FACTORY VALUES



## DETECTION FIELDS

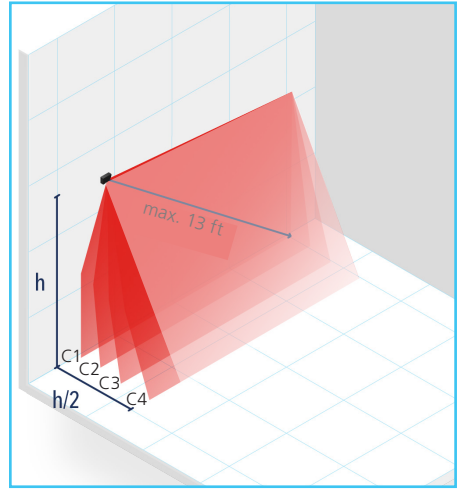
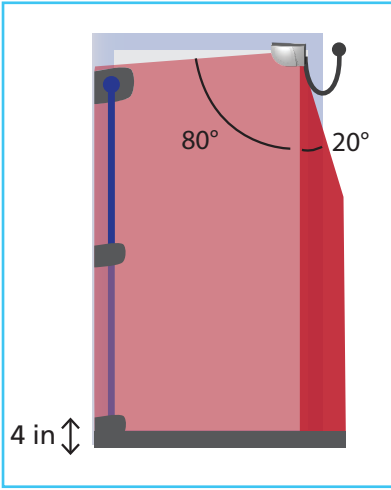

 DOOR LEAF SAFETY

 PINCH ZONE SAFETY

 UNCOVERED ZONE  
*adjustable by remote control*  
factory value: 4 in

Check the detection fields using our online sizer tool:  
<https://eu.beasensors.com/sizer/flatscan/>



## SERVICE MODE

Service Mode **deactivates all detection fields** for 15 minutes and can be useful during an installation, a mechanical learn of the door, or maintenance work.

- To enter Service Mode, push and hold the button for at least 3 seconds. The LED will turn off.
- To exit Service Mode, push and hold again for at least 3 seconds.

Service Mode is deactivated automatically when a teach-in is launched.

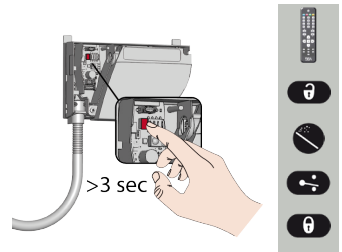





## TROUBLESHOOTING











In case of unwanted reactions of the door, verify whether the problem is caused by the sensor, the door controller, or a nearby radar sensor. To do so, activate Service Mode (no safety) and cycle the door open. *Be sure to exit Service Mode when finished with troubleshooting activities.*

If the door cycle is completed successfully, check the sensor. If not, verify the door controller, the wiring, or a radar sensor.

Keep a minimum distance of 6 inches between the FLATSCAN SW and radar sensors or use the LZR®-Flatscan protective cover to avoid unwanted reactions of the door.

 	The red, green, or blue LED is ON sporadically or permanently and the door does not react as expected	Bad teach-in	Launch a new teach-in (closed door).	
		Unwanted detections (due to environment or external conditions)	1	Make sure the flexible cable does not cause detections.
			2	Verify if the laser window is dirty and clean it with compressed air. Then wipe it carefully with a damp and clean microfiber cloth if necessary. <b>Attention:</b> The surface of the laser window is delicate).
			3	Launch a new teach-in (closed door).
		4	Switch DIP 2 to off (critical environment).	
	The red LED blinks quickly when trying to unlock the sensor.	The sensor is protected by a password	Enter the right password. If you forgot the code, cut and restore the power supply to access the sensor without entering a password during 1 minute.	
	The sensor does not react at power-on	Inverted power supply	Check wiring (red +, black -).	
		Faulty cable	Replace cable.	
		Faulty sensor	Replace sensor.	
The sensor does not react when powered	Test/Monitoring error	If using purple wires for monitoring, ensure they are connected to the door control test/monitoring inputs and that test/monitoring is enabled. The purple wires are auto-sensing and not polarity sensitive.		
	Service Mode is activated	Press the push button for at least 3 seconds to exit Service Mode.		
Opening function does not react at power on	The opening function is deactivated during 30 seconds at power on	Wait 30 seconds.		
	It is not possible to adjust background and pinch zone by remote control.	Incorrect DIP switch position	Adjusting background: Ensure DIP switch 3 is ON. Adjusting pinch zone: Ensure DIP switch 4 is ON.	
	The remote control does not react.	Dead batteries / faulty remote control	Replace batteries or remote control.	

## TROUBLESHOOTING (cont.)

	The ORANGE LED is on permanently.	The sensor encounters a memory problem.		Replace sensor.
	The ORANGE LED flashes quickly.	DIP switch setting awaiting confirmation.		Confirm the DIP switch setting: long push on the push button.
	The ORANGE LED flashes 1x every 3 seconds.	The sensor signals an internal fault.		Cut and restore power supply. LED flashes again, replace sensor.
	The ORANGE LED flashes 2x every 3 seconds.	Power supply is out of limit.	1	Check power supply (voltage).
			2	Reduce the cable length or change cable.
	The ORANGE LED flashes 3x every 3 seconds.	Communication error between modules	1	Check wiring between primary and secondary modules.
			2	Check wiring between interface card and laser head.
	The ORANGE LED flashes 4x every 3 seconds	The sensor does not see its background.  Something close to the sensor is masking part of the detection field.	1	Turn off DIP 3 (deactivate background).
			1	Ensure the laser window is not scratched. If it is, replace sensor.
			2	Remove all masking elements (insects, spider web, flexible tube, window protection).
			3	Verify if the laser window is dirty and clean it with compressed air. Then wipe it carefully with a damp and clean microfiber cloth if necessary. <b>Attention:</b> The surface of the laser window is delicate.
	The ORANGE LED flashes 5x every 3 seconds.	Teach-in error	1	Check whether all teach-in requirements are fulfilled (see page 8) and launch a new teach-in (closed door).
			2	Adjust the tilt angle of the laser curtain and launch a new teach-in (closed door).
	The ORANGE LED flashes 6 x every 3 seconds.	Permanent faulty measurements of door position.	1	Adjust the field dimensions by remote control.
			1	Launch a new teach-in (closed door).
	The ORANGE LED flashes 6 x every 3 seconds.	Sporadic faulty measurements of door position.	2	If orange LED flashes again, contact BEA.
			1	Clear field and wait until the door closes.
			2	If the door does not close, cut power supply and restore it once the door is fully closed.
			3	Launch a new teach-in (closed door).

# TECHNICAL SPECIFICATIONS

<b>Technology</b>	LASER scanner, time-of-flight measurement
<b>Detection mode</b>	Presence
<b>Max. detection range</b>	13' (diagonal) with reflectivity of 2% (e.g. W = 5' → max. H = 12')
<b>Recommended mounting height</b>	75 – 98"
<b>Opening angle</b>	Door leaf safety: 80° Pinch zone safety: 20°
<b>Angular resolution</b>	Curtain 1: 0.2° Curtain 2: 1° Curtain 3: 1.7° Curtain 4: 2.5°
<b>Tilt angles</b>	0 – 5°
<b>Typ. min. object size</b>	¾" @ 13' in curtain C1
<b>Emission characteristics (IEC 60825-1)</b>	IR LASER: wavelength 905 nm; output power < 0.1mW; Class 1
<b>Supply voltage</b>	12 – 24 VDC ±15% (to be operated from SELV-compatible power supplies only)
<b>Power consumption</b>	< 2 W
<b>Response time</b>	Typ. <120 ms Max. 220 ms
<b>Output</b> max. switching voltage max. switching current	3 electronic relays (galvanic isolation - polarity free) 42 VAC/VDC 100 mA
<b>LED signals</b>	1 RGB LED: detection/output status
<b>Dimensions</b>	5 ¾" (L) × 3 ½" (H) × 2 ½" (D) (spacer: D + 1 ½")
<b>Material - Color</b>	PC/ASA - Black/Aluminum/White
<b>Protection degree</b>	IP44 (IEC 60529)
<b>Temperature range</b>	-13 – 140 °F
<b>Humidity</b>	0 – 95% non-condensing
<b>Vibrations</b>	< 2 G
<b>Min. door leaf speed</b>	2°/sec
<b>Compliance</b>	ISO 13849-1 Pl "d"/ CAT2; IEC 60825-1; IEC 62061 SIL 2

Specifications are subject to change without prior notice.  
All values measured in specific conditions.

## BEA, INC. INSTALLATION/SERVICE COMPLIANCE EXPECTATIONS

BEA, Inc., the sensor manufacturer, cannot be held responsible for incorrect installations or incorrect adjustments of the sensor/device; therefore, BEA, Inc. does not guarantee any use of the sensor/device outside of its intended purpose.

BEA, Inc. strongly recommends that installation and service technicians be AAADM-certified for pedestrian doors, IDA-certified for doors/gates, and factory-trained for the type of door/gate system.

Installers and service personnel are responsible for executing a risk assessment following each installation/service performed, ensuring that the sensor/device system performance is compliant with local, national, and international regulations, codes, and standards.

Once installation or service work is complete, a safety inspection of the door/gate shall be performed per the door/gate manufacturer's recommendations and/or per AAADM/ANSI/DASMA guidelines (where applicable) for best industry practices. Safety inspections must be performed during each service call – examples of these safety inspections can be found on an AAADM safety information label (e.g. ANSI/DASMA 102, ANSI/DASMA 107, UL294, UL325, and International Building Code).

Verify that all appropriate industry signage, warning labels, and placards are in place.



A Halma company

Tech Support & Customer Service: 1-800-523-2462

General Tech Questions: techservices-us@BEAsensors.com | Tech Docs: www.BEAsensors.com