

# FLY AND FLY ERT

Request - to - Exit Sensor

(US version)



Visit website for  
available languages of  
this document.

## DESCRIPTION

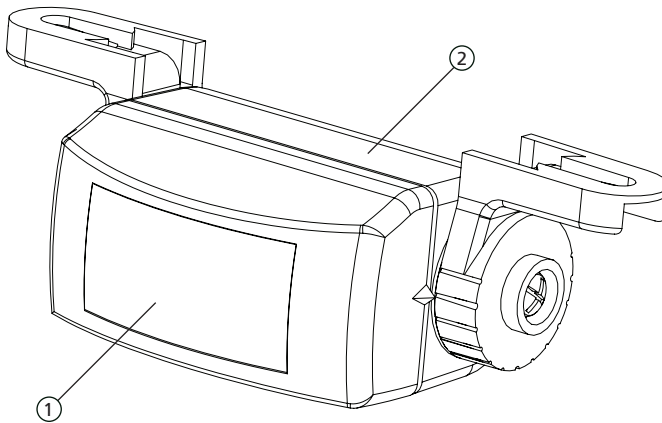

1. Lens (mask inside)
2. Housing (sensor inside)

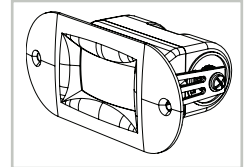

FLY CEILING ADAPTER (FCA)

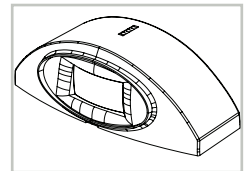

FLY SURFACE ADAPTER (FSA)

The FLY is **not recommended for activation on pedestrian, automatic doors** because the passive infrared technology recognizes temperature changes (e.g. body temperature) for detection.

As such, the FLY will not recognize motion associated with inanimate objects such as hospital beds, gurneys, shopping carts, etc.

## PRECAUTIONS



### CAUTION

- ❑ Shut off all power going to header before attempting any wiring procedures.
- ❑ Maintain a clean and safe environment when working in public areas.
- ❑ Constantly be aware of pedestrian traffic around the door area.
- ❑ Always stop pedestrian traffic through the doorway when performing tests that may result in unexpected reactions by the door.
- ❑ Always check placement of all wiring before powering up to ensure that moving door parts will not catch any wires and cause damage to equipment.
- ❑ Ensure compliance with all applicable safety standards (i.e. ANSI A156.10) upon completion of installation.
- ❑ DO NOT attempt any internal repair of the components. All repairs and/or component replacements must be performed by BEA, Inc. Unauthorized disassembly or repair:
  1. May jeopardize personal safety and may expose one to the risk of electrical shock.
  2. May adversely affect the safe and reliable performance of the product resulting in a voided warranty.

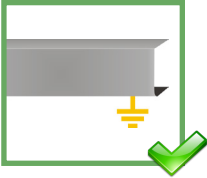

The door control system and the header cover profile must be correctly grounded.



Only trained and qualified personnel are recommended to install and set up the sensor.

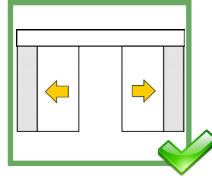

Always test the proper operation of the installation before leaving the premises.

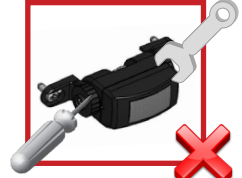

The warranty is invalid if unauthorized repairs are made or attempted by unauthorized personnel.

## PREPARING THE SENSOR

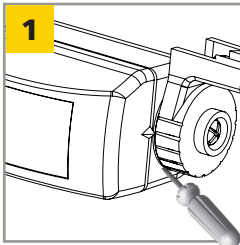

Insert a small screwdriver on the side of the housing and gently pry off cover.

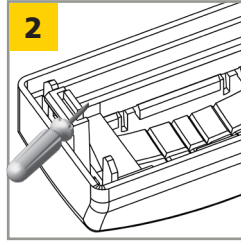

If the mask needs to be removed, pry up with a screwdriver on the small legs of the lens.

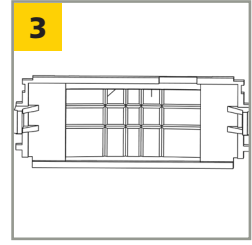

Adjust sensing field by removing segments of the mask with a diagonal cutter (or similar).<sup>1</sup> See diagrams below for detection patterns.

*\*remove gray portions to achieve desired field\**

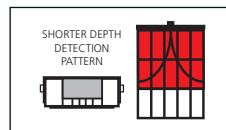
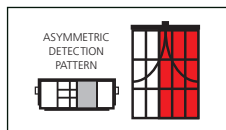

### NOTES:

1. It is not necessary to use the mask. Installing the lens without the mask will allow maximum detection size. If using the mask, it is necessary to cut at least one segment to allow detection.

## PREPARING THE SENSOR (cont.)

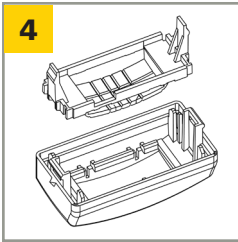

Reinstall the mask (if needed) by placing the mask inside the cover so that the legs of the mask slide into the clips. Gently work the mask's legs until it clicks.

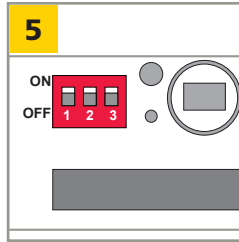

Adjust DIP switches for application.<sup>1</sup> See table below for DIP switch settings.

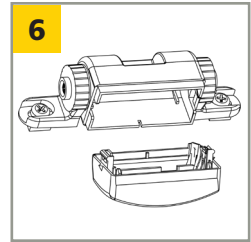

Replace the cover by matching the small tab (center of cover) to the slot in the housing, then gently push the cover until it snaps.<sup>2</sup>

DIP SWITCH	SETTING	ADJUSTMENTS*
1	Sensitivity	ON: <b>high</b> OFF: low
2	Relay Output	ON: passive output ** OFF: <b>active output</b> ***
3	Hold Time (FLY)	ON: <b>2 sec</b> OFF: 0.5 sec
	Hold Time (FLY ERT)	ON: 30 sec OFF: <b>15 sec</b>
* Factory Settings are in <b>bold</b> . ** Passive output: relay contact open during detection, closed during non-detection *** Active output: relay contact closed during detection, open during non-detection		

### NOTES:

1. Sensitivity, relay output, and hold time can all be adjusted.
2. It is easiest to insert both legs of the cover at once and then push the two pieces together.

## MOUNTING & WIRING

1. Attach template to frame above door.<sup>1</sup>
2. Drill holes and pass cable through template.
3. Place sensor on template and attach using the provided screws.

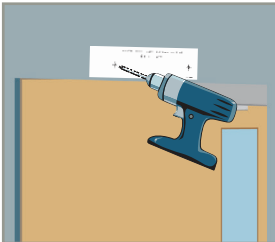

*The sensor must be secured to avoid vibrations.  
Ensure no objects are present in the sensing field during set-up.*

4. Connect the sensor cable to the unit. Use the table provided here to ensure correct wiring. *Input power is not polarity-sensitive.*
5. The LED will flash for a few seconds after start-up. *LED will also illuminate when the sensor detects motion.*

PIN	FUNCTION
1	12 – 24 V (POWER)
2	12 – 24 V (POWER)
3	RELAY COM
4	RELAY NO
5	RELAY NC

### NOTES:

1. If using the Ceiling Adapter or Surface Adapter, ensure that proper mounting templates are used.

## TROUBLESHOOTING

Door will not unlock. LED does not illuminate.	Sensor power is off.	Check power supply.
		Check supplied voltage.
Lock does not release upon detection, but LED illuminates.	Incorrect relay output.	Change #2 DIP switch position.
	Incorrect wiring.	Verify correct wiring.
		Replace sensor.
Size of detection field does not meet requirements	Incorrect cut-out of masking lens.	Cut a new lens to meet the required detection field size.

## TECHNICAL SPECIFICATIONS

Technology:	Passive infrared with microprocessor
Mounting Height (variable):	10' max. (recommended 6'6" – 8'0")
Mounting Angles:	0 – 180°
Power Supply:	12 – 24 VAC ±10% (50/60Hz) 12 – 24 VDC -10% / +30%
Current Consumption:	< 10 mA (20 mA if the relay output is activated)
Contact Rating (output relay):	1 A / 75 VDC <b>OR</b> 50 VAC potential-free contact NO/NC
Optical Characteristics:	Passive infrared with 4 elements 15 Fresnel lenses with full independent making possibilities
Warm-up Time:	10 seconds
Response Time:	Max. 200 microseconds
Relay Hold Time:	
Fly:	0.5 or 2 seconds
Fly ERT:	15 or 30 seconds
Operating Temperature:	-22 – 140 °F (-30 – 55 °C)
Immunity:	Immune to electrical and radio frequency interference
Cable:	9' four-conductor cable with 5-pin connector
Weight:	1.4 oz. (40 g)
Sensor Dimensions:	4" (L) x 1" (H) x 1.8" (W) 100 mm (L) x 25 mm (H) x 45 mm (W)
Housing Color:	Black

*Specifications are subject to change without prior notice.  
All values measured in specific conditions.*

### BEA, INC. INSTALLATION/SERVICE COMPLIANCE EXPECTATIONS

BEA Inc., the sensor manufacturer, cannot be held responsible for incorrect installations or incorrect adjustments of the sensor/device; therefore, BEA Inc. does not guarantee any use of the sensor/device outside its intended purpose.

BEA Inc. strongly recommends that installation and service technicians be AAADM-certified for pedestrian doors, IDA-certified for doors/gates, and factory-trained for the type of door/gate system.

Installers and service personnel are responsible for executing a risk assessment following each installation/service performed, ensuring that the sensor/device system performance is compliant with local, national, and international regulations, codes, and standards.

Once installation or service work is complete, a safety inspection of the system shall be performed and documented per the manufacturer's recommendations or industry guidelines. Examples of compliance may apply to ANSI 156.10, ANSI 156.19, ANSI/DASMA 102, ANSI/DASMA 107, UL294, UL325, and International Building Code.



Tech Support & Customer Service: 1-800-523-2462  
General Tech Questions: [techservices-us@BEAsensors.com](mailto:techservices-us@BEAsensors.com) | Tech Docs: [www.BEAsensors.com](http://www.BEAsensors.com)