

BEAMBOX

Universal activation and presence sensor

User's Guide



DESCRIPTION

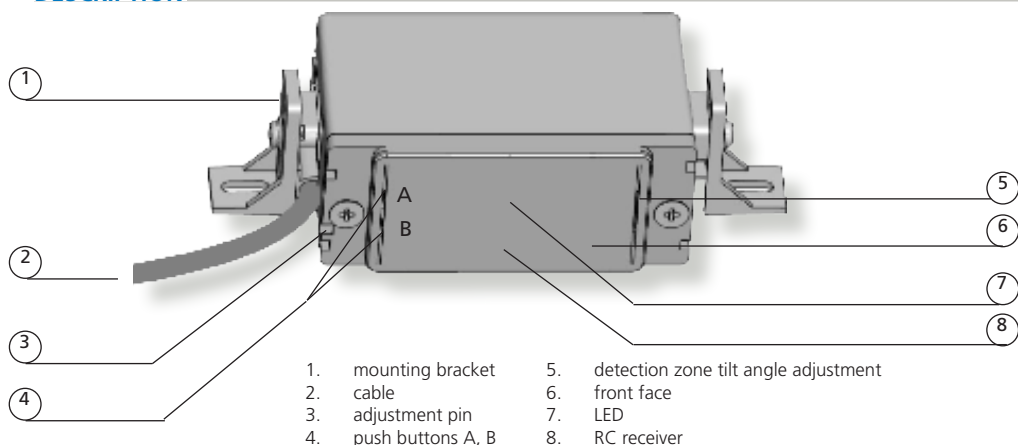

TECHNICAL SPECIFICATIONS

Technology:	active infrared
Detection mode:	motion and presence
Detection zone:	3.3 ft (W) x 3.9 ft (D) (mounting height 6.5 ft; tilt angle 20°)
	5 independent IR-spots with a diameter of typ. 0.43 in
Reaction time:	< 100 ms
Supply voltage:	12V - 30V AC ±10%; 12V - 45V DC ±10%
Mains frequency:	50 - 60 Hz
Power consumption:	< 3 W (VA)
Output:	relay (free of potential change-over contact)
Max. contact voltage:	42 V AC - 60 V DC
Max. contact current:	1A (resistive)
Max. switching power:	30 W (DC) / 60 VA (AC)
Monitoring input:	optocoupled, free of potential
Input voltage:	10V-24V DC
Input current:	<10mA (@ 24V)
Connection on sensor side:	unpluggable integrated 7-pin connector
Hold time:	0.5 s to 9 s (adjustable)
LED-signal:	red and green
Mounting height:	max. 8.2 ft (flush-mounting)
Degree of protection:	IP41
Temperature range:	-13 °F to + 136 °F (operating); -22 °F to + 140 °F (storage)
Dimensions:	5.5 in (W) x 1.5 in (H) x 2.2 in (D)
Tilt angles:	0° to 20° vertical in steps of 5°
Cable length:	8 ft
Material:	Polycarbonate
Weight:	3.5 oz

Specifications are subject to changes without prior notice - Measured in specific conditions.

1 MOUNTING & WIRING

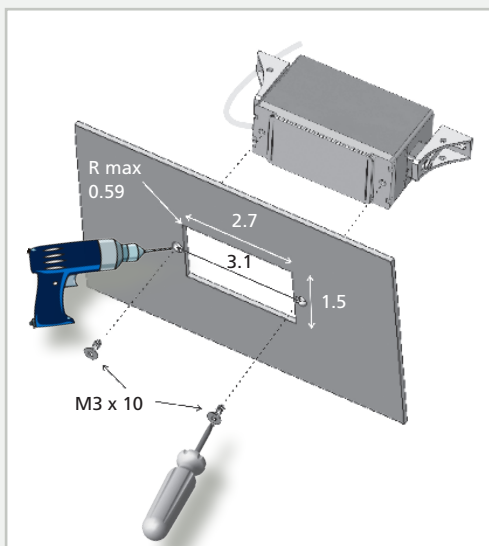

All dimensions are in inches

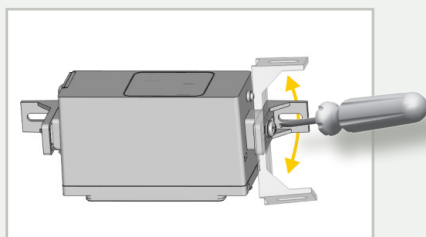

Loosen the screws to adjust the brackets to your application if necessary.

█	RED - POWER SUPPLY +
█	BLACK - POWER SUPPLY -
█	WHITE - COM
█	GREEN - NO
█	YELLOW - NC
█	PURPLE - MONITORING +
█	BLUE - MONITORING -

2 MECHANICAL ADJUSTMENTS

TILT ANGLE

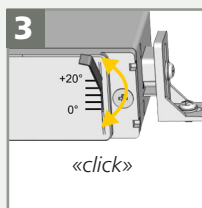
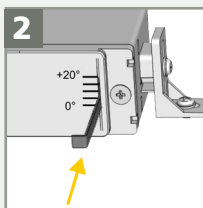
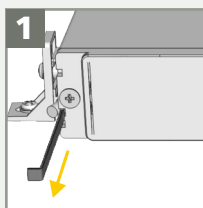

Typ. detection zone dimensions
(at 6.6 ft with all spots activated):

0° = 39 in (W) x 39 in (D)

20° = 39 in (W) x 47 in (D)

PUSH BUTTONS

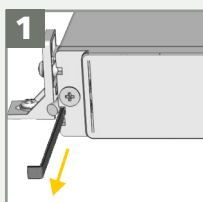

Without remote control, you can set two parameters using the push buttons:

PUSH BUTTON A: IMMUNITY (1-4)

- Push once to enter into programming mode. The red LED flashes. The number of flashes indicates the current value (see next page).
- Push again to increment the immunity. The red LED indicates the new setting. When you reach value 4 and push again, the immunity skips to value 1 (rolling system).
- Push button B to close the session, once you have reached the required immunity value.

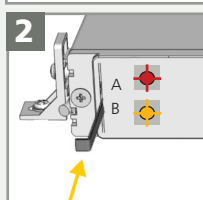

PUSH BUTTON B: DETECTION ZONE (1-9)

- Push once to enter into programming mode. The green LED flashes. The number of flashes indicates the current value (see next page).
- Push again to go to the next value. The green LED indicates the new selected field. When you reach value 9 and push again, you will go back to value 1 (rolling system).
- Push button A to close the session, once you have reached the required sensitivity value.

If no button has been pushed for 1 minute, the programming mode is automatically ended.

3 DETECTION ZONES

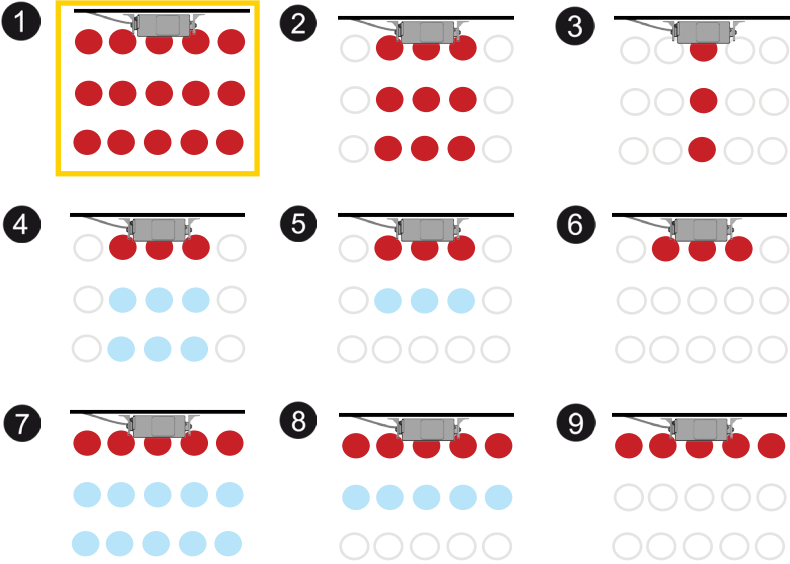
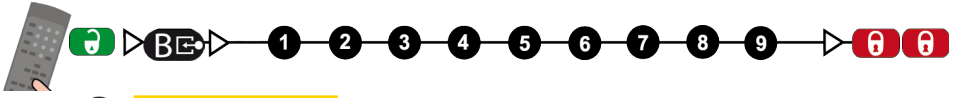

mounting height: 6.6 ft - tilt angle: 20°

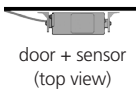

- inactive spot
- active spot - motion
- active spot - presence



TIP!
Use the Spotfinder to check the position of the activated IR-spots.

4 SETTINGS



IMMUNITY		lower	low	high	higher						
PULSE FREQUENCY		low	med	high							
OUTPUT CONFIGURATION		A	P	A = active output (NO-contact) P = passive output (NC-contact)							
HOLD TIME		0.5 s	1 s	2 s	3 s	4 s	5 s	6 s	7 s	8 s	9 s
MAX. DURATION OF PRESENCE DETECTION		20 s	1 min	2 min	3 min	5 min	7 min	10 min	15 min	20 min	25 min
DOOR CONTROL		auto	open	closed	open = sensor is continuously in detection > LED ON closed = sensor is in standby and does not detect > LED OFF						

CHECKING A VALUE: > >

x = number of flashes = value of the parameter









FACTORY VALUES:



LAUNCHING SETUP:



TROUBLE SHOOTING

	The sensor will not power up.	Faulty power supply.	1 Check power supply.
	The door opens and closes constantly.	The sensor is disturbed by the door motion or vibrations.	1 Increase the tilt angle of the sensor. 2 Verify if the sensor is mounted correctly.
	Two sensors in proximity to each other are disturbed.	The overlapping detection fields create interferences.	1 Choose a different pulse frequency for each sensor.
	The sensor does not respond to the remote control.	Batteries in the remote control are weak or installed improperly.	1 Check and change the batteries if necessary.
		Remote control oriented poorly.	1 Point the remote control towards the sensor.
		The sensor is doing a setup.	1 Cycle power supply. Stand outside of the detection zone until the setup is finished.
	The sensor does not unlock when the access code is entered.	Incorrect access code.	1 Cycle power supply. No code is required during the 1st minute after power on. Set new access code by following the steps below.
	The red LED flashes quickly.	The sensor goes into security mode after a faulty internal test.	1 Replace sensor.

PLEASE KEEP FOR FURTHER USE – DESIGNED FOR COLOR PRINTING

ACCESS CODE

The access code (1 to 4 digits) is recommended for sensors installed close to each other.

SAVING AN ACCESS CODE:



DELETING AN ACCESS CODE:



Once you have saved an access code, you always need to enter this code to unlock the sensor. If you forget the access code, **cycle the power supply**. For the first minute, you can access the sensor without introducing any access code.

-  The device should not be used for purposes other than its intended use. All other uses cannot be guaranteed by the manufacturer of the sensor.
- The installer of the door system is responsible for carrying out a risk assessment and installing the sensor and the door system in compliance with applicable national and international regulations and standards on door safety.
- The manufacturer of the sensor cannot be held responsible for incorrect installations or inappropriate adjustments of the sensor.

ANSI / AAADM Compliance American Association of Automatic Door Manufacturers

Upon completion of the installation or service work, at a minimum, perform a daily safety check in accordance with the minimum inspection guidelines provided by AAADM. Provide each equipment owner with an owner's manual that includes a daily safety checklist and contains, at a minimum, the information recommended by AAADM. Offer an information session with the equipment owner explaining how to perform daily inspections and point out the location of power/operation switches to disable the equipment if a compliance issue is noted. The equipment should be inspected annually in accordance with the minimum inspection guidelines. A safety check that includes, at a minimum, the items listed on the safety information label must be performed during each service call. If you are not an AAADM certified inspector, BEA strongly recommends you have an AAADM certified inspector perform an AAADM inspection and place a valid inspection sticker below the safety information label prior to putting the equipment into operation.

