



# ALARM LOCK

Wireless & standalone access control door solutions trusted by more schools & universities, offices, retail chains & healthcare providers

# table of contents

TRIOLOGY T2/ DL2700 STANDALONE DIGITAL PIN CODE LOCKS, CYLINDRICAL, DUAL-SIDED, MORTISE & EXIT DOORS . . . . .	2
TRIOLOGY CLASSROOM LOCKDOWN DL2700LD . . . . .	2
TRIOLOGY AUDIT TRAIL/PC-PROGRAMMABLE PUSHBUTTON LOCKS . . . . .	3
TRIOLOGY PROX LOCKS WITH HID PROX ID CARD READERS . . . . .	4
TRIOLOGY DOUBLE-SIDED PIN CODE AND PIN/PROX STANDALONE LOCKS . . . . .	5
TRIOLOGY STANDALONE LOCKS FOR PRIVACY AND SPECIAL APPLICATIONS . . . . .	6
TRIOLOGY HIGH SECURITY STANDALONE MORTISE LOCKS . . . . .	7
TRIOLOGY EXIT ADDS AUDIT TRAIL AND AUTO LOCK/UNLOCK TO PANIC EXITS . . . . .	8
TRIOLOGY NARROW STILE TRIM FOR ALL GLASS/ALUMINUM DOORS AND PANIC EXIT DOORS . . . . .	9-10
MATCHING TRIOLOGY DIGITAL PIN & PROX ACCESS 12/24V KEYPADS WITH AUDIT TRAIL . . . . .	10
TRIOLOGY AUDIT TRAIL AND PROGRAMMING ACCESSORIES, FINISHES AND ORDERING INFORMATION . . . . .	11
WIRELESS NETWORK KEYPADS & NETPANEL . . . . .	12-13
TRIOLOGY NETWORK WIRELESS 802.11/ETHERNET LOCK ACCESS SYSTEMS . . . . .	14-17
ILOCK APP . . . . .	17
ARCHITECH DESIGNER WIRELESS ACCESS CONTROL LOCKING PLATFORM . . . . .	18-21
SIRENLOCK EXIT ALARMS: WATERPROOF, INTERIOR, AND DELAYED EGRESS . . . . .	22
REMOTE RELEASE MAG LOCKS, POWERMAGS AND RTES . . . . .	23
ADVANCED DOOR ALARMS . . . . .	24
ESSENTIAL ADD-ONS AND EXTRAS . . . . .	25
TRIOLOGY FAMILY OF ACCESS PRODUCTS CHART . . . . .	26-27
K-12 AND CAMPUS LOCKDOWN SOLUTIONS . . . . .	28
ABOUT US, RETAIL LOCKSMITHS PROFIT CENTER PROGRAM AND TRAINING . . . . .	29

**Trilogy: The leading  
electronic access locks**



# Trilogy:®



hospital



retail



airport



schools



pharmacy



office



### Retrofit Any Knobset

DL2700/LD Trilogy® T2 Grade 1 standalone digital cylindrical keyless door lock, fingertip programmable - page 2



### Audit Trail

DL2800/DL3000, DL3200 Trilogy audit trail cylindrical security locks with PC Programming & Schedules page 3



### ID Card Access

PDL3000 Trilogy HID® Reader/Enroller Prox Lock with audit trail page 4  
+ New iClass/One-Card Model PDL8200 page 16



### Vandalism Protection

PL3000 Prox-only vandal proof lock page 4



### Airport Jetway Use and more

DL/PDL5300, DL5200 Dual sided PIN/prox lock with audit trail page 5



### Communicate Wirelessly

Trilogy Networkx® communicate wirelessly via Ethernet or 802.11 now including Networkx Keypads & Controller plus Exit Trim DL/PDL6100, DL/PDL6500, NET-DKPAK, NET-PDKPAK, NETWORKPANEL, ETDLN/ETPDN page 12-17



### Restrooms/Classrooms

DL/PDL4100, DL/PDL4500 DL2700LD Trilogy Privacy/Lock Down Pushbutton - for restrooms, on-call rooms, file rooms, fitting rooms, classrooms page 6



### High Security PIN/Prox ID

DL2700CR/DB, P/DL3500 Trilogy high security mortise locks and keyless gate locks with and without prox page 7



### Glass/Aluminum Doors

DL1200, DL1300, PDL1300 Trilogy Narrow Stile Pushbutton aluminum door trim latch locks for PIN or Prox ID card access page 9



### Exit Doors

ETDL2700, ETDL, ETPDL TrilogyExit retrofits existing exit bars and saves manpower on guard tours page 8



### Access Keypads

DK3000 & PDK3000 Trilogy Matching Weatherproof PIN/ Prox. ID Access Keypads with audit trail page 10

### Glass & Standard Pushbar Doors

DL1200, DL/PDL1300ET TrilogyExit keyfree convenience and greater security for panic exit devices on standard & narrow stile aluminum frame glass doors page 9 & 10

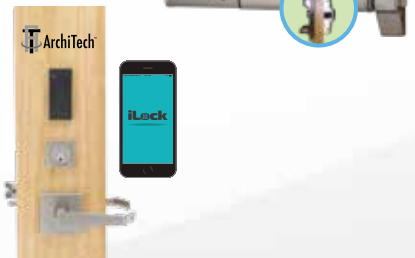

### ArchiTech Series Locks

Designer Wireless Access Control Systems page 18-21

Keyless access locks trusted by more leading retailers, firms, hospitals, schools & airports

# Trilogy T2: Electronic cylindrical digital locks



Trilogy® T2 standalone digital cylindrical lock : #1 in its class

## DL2700 Series

### More powerful & More T2 models

- More codes: up to 100 3-6 digit codes: 1 master, 10 managers, 90 basic users, 3 one time service codes
- Uses 5AA batteries; 5 years battery life or 200,000 cycles, typ.
- For outdoors, specify WP weatherproof models -31° to +151°F (-35° to +66°C)
- **DL5200 Dual-sided option**, see pg 5



ADA-compliant levers



Curved regal handle option



Lever sets feature clutch mechanism ensuring longer life and complies with ADA specs providing barrier-free access to the disabled.

## Trilogy® T2 Lockdown: Ideal for School & Campus Security

### DL2700LD Series

#### Classroom Lockdown Indicator & Keyfob-Activation

- Lockdown up to four locks with one compact remote keyfob, supplied (up to 50 RR-4KEYFOB keyfobs supported per lock)
- Bright visual lockdown indicator bar on inner door; Outside small indicator light flashes and/or beeps when in lockdown
- Up to 100 different user codes (3-6 digits)

- Uses 5AA batteries; 3 to 4 years battery life or 100,000 cycles, typ.
- Grade 1 Durability; Weather-Resistant, Standard



2" Remote Keyfob controls up to 4 locks and works up to 75' away (RR-4KEYFOB)

**More Trilogy T2 Models:** Field-proven electronic standalone pushbutton locks available in cylindrical, mortise, dual sided and exit trim models to retrofit with panic exit bars or narrow stile aluminum/glass doors' latch locks

#### Trilogys feature:

- In an hour, add dependable wireless access control, one door at a time—easily retrofit standard knobsets
- Support 100 to 2000 PIN codes (3-6 digits); some with built-in HID prox readers for use with access ID cards/fobs
- Multi-level user codes & one-time service codes. Free passage, group- or total lock-out modes, too
- All are fingertip programmable at vandalproof all-metal keypad
- PC programmable models also feature printable audit trail, auto-lock/unlock scheduling saving guard/manpower costs
- Longer-life battery operation – 200,000 cycles typical (cylindrical models use 5AA off-the-shelf batteries); low battery alert
- Key override, standard core (supplied) or interchangeable core prep
- Durable BHMA Grade 1 cylindrical Lockset; Non-handed. Curved Regal handle option.
- Programmable relay functions
- Weatherproof models -31° to +151°F (-35° to +66°C)



**DL2700CR/DB Mortise T2 Trilogy** standalone digital lock for high security locking. Choice of classroom or deadbolt functions, see also pg 7



**ETDL2700 T2 Trilogy Exit trim** for use with exit device, see also pg 8



**DL1200 Narrow stile T2 Trilogy** for glass or exit doors, see also pg 9, 10



# Trilogy T3: Choice of audit trail pushbutton locks

## T3 advanced digital lock with audit trail

### DL3200 Series

#### High Capacity Audit Trail Lock

Enhanced version of the original DL3000

- 2000 user codes (3-6 digits)
- Multilevel security - Master; manager; supervisor; basic users
- Program at keypad or with PC-and/or data-transfer module
- 40,000 event audit trail logs with time-/date-stamp of access by user; create PC reports or at hand-held wireless printer
- 500 scheduled lock/unlock events
- Quick passage mode (without being in program mode)
- Weatherproof -31° to +151°F (-35° to +66°C)
- 5AA Battery operated; 80,000 cycles, typical

### DL3000

Original Audit Trail Trilogy, similar to above

- 300 multilevel user codes; 1600 event log
- 150 scheduled lock/unlock events
- For outdoors, specify **WP** weatherproof models -31° to +151°F (-35° to +66°C)



Add Remote-Release convenience to any cylindrical Trilogy installation with keyfobs or desk-mounted button

- Easy & Cost Effective
- Retrofits Cylindrical Trilogy Locks dating all the way back to 2000 (with a serviceable battery pack) :RR-TrilogyKit
- For Network Locks, too! Just purchase either the keyfob (shown above left) or desk-mount release button (pg 8)

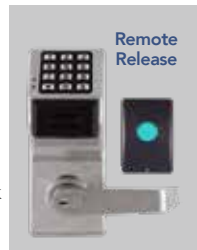

*Ideal for receptionists.*

## Trilogy economical audit trail lock

### DL2800

#### Cylindrical Lock

- 1000 event audit trail log, time-stamped by day, date, time and user
- 150 scheduled automatic lock/unlock events, etc.
- 200 user codes: Master, manager, supervisor and basic users. Also one-time service code (3-6 digits)
- Weatherproof -31° to +151°F (-35° to +66°C)
- 5AA Battery operated; 80,000 cycles, typical

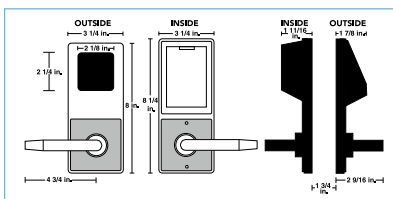

Trilogy cylindrical locks retrofit standard knobsets simply, in about an hour



Turn Standalone Trilogy Locks into Wireless Networked Networkx Locks with Field Upgrade Kits for Standalone PIN or PIN/Prox Cylindrical or Mortise Models. P/DL6100 and P/DL6500 upgrade kits available. iClass available – PDL8200 upgrade kit.

# Prox ID card support: With Trilogy durability



## Trilogy prox lock with audit trail

### PDL3000

#### PIN/Prox Cylindrical

- Use the same ID cards as hardwired access systems & install in an hour
- Save all the downtime and 1/2 the cost of hardwired systems
- Provide access for up to 2000 users, with prox ID-cards or 3 to 6 digit codes including: Master, manager, supervisor and basic user. Users are individually programmed to use a card only, code only, or, for the highest security, both card and code.
- Built-in HID Prox reader for entry with HID125KZ prox ID cards and keyfob credentials
- Grade 1 BHMA Certified durability and rugged clutch mechanism ensure long dependable life
- Weatherproof performance for indoor and outdoor applications, wide operating temperature range of -31°F to +151°F (-35°C to +66°C)
- Electronic master key system with access customized to each user's hours - Give each user access to common areas and/or their individual area(s) and do so defined by the actual times they are permitted entry there.
- Tap and Add batch ID card enrollment mode at lock or download from a PC
- 40,000 event audit trail; 500 scheduled events
- PC programming/reporting

- Quick passage mode
- 5AA battery operation; 60,000 cycles, typical

**For iClass Prox Locks with 13.56 MHz support for one-card solutions - also see PDL8200 pg 16**

**PDL8200** – Model also logs mechanical key override use

## Trilogy prox only defeats vandals

### PL3000

#### Prox Only Cylindrical

- Keypad-less version of above for ultimate vandal-proofness in harshest environments
- Accepts HID prox cards and keyfobs for access
- Easy Tap & Add batch ID card enrollment mode allows many cards to be quickly added without PC –also- downloadable from PC or enroller tool
- 40,000 event audit trail log, 500 scheduled events
- PC programming/reporting

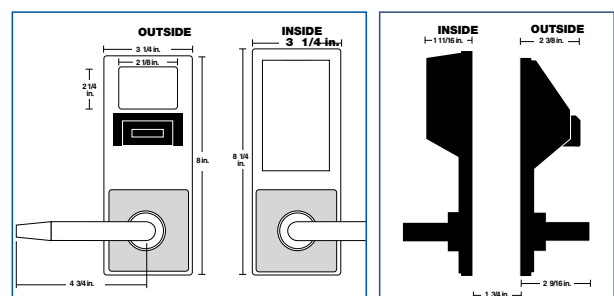

# Double Sided: Access on both sides of the door



A favorite solution for airport jetways!



## DL5200

- Incorporates all of the important features of DL2700 (T2) into a double-sided lock
- Easy to add, delete, change users at the keypad
- Programming user codes on one side of the door works both sides, cutting your time & labor in half
- Ideal for community pool gates, courtyard gates, airport jetway doors, interrogation rooms, psych wards
- Comes with LED & audible entry indicators
- 100 user codes (3-6 digit codes)
- Standard prep & IC models available
- Weatherproof -31° to 151°F (-35° to +66°C)
- 5AA batteries operated, 80,000 cycles, typical

## DL5300/PDL5300

- 2000 user codes (3-6 digits) and/or accepts HID prox cards and keyfobs (prox model PDL5300)
- Direction-specific access assignable per user programmable access for each user for one or both sides of the door
- Up to 40,000 event audit trail log, time-stamped by day, date, time and user (PC or data module reportable)
- 500 scheduled events, including 4 quick schedules
- Data port for programming lock and querying audit trail is on primary side of door, along with functioning mechanical key override
- 4 programming levels, 4 user groups
- 5AA battery operated; 60,000 cycles, typical



Note: Key override operates latch only from primary side.

PDL5300 model features 2 built-in HID prox card ID readers on both sides.



# Trilogy 4100/4500: Privacy or lock down features



Standard Cylindrical Model with privacy button (center, top) featured



Flashing LED inside and outside indicates the room is occupied or locked



Also available in mortise model



Standalone Trilogy® locks with privacy/lock down pushbutton on inner door (mortise & cylindrical pin or pin/prox models)

## DL4100 and Prox PDL4100

Similar to the DL3200 features plus:

- Interior LED on the inside housing indicates when the privacy session is active
- Rest assured knowing that you are safe within the room, while locking out unauthorized users.
- 2000 PIN or PIN/Prox user codes; 500 scheduled events; 40,000 audit trail
- Privacy Pushbutton – Push button on inside door to temporarily lock-out keypad codes (programmable option)
- Occupied and multi-status LED indicator, flashes when privacy session is active
- Self-stick instructional signage, supplied (bilingual)
- Keypad or PC programming/reporting
- Right- or left-hand, classroom or deadbolt function models, only with 4500 Series
- 1-3/8" mortise cylinder & ASA strike, matching function supplied, only with 4500 Series
- 5AA battery-pak operated; 60,000 cycles, typical
- 3 Architectural finishes (US3 polished brass, 26D satin chrome, 10B duronodic)
- Weatherproof -31° to +151°F (-35° to +66°C)

**Mortise DL4500, Prox Mortise PDL4500 and Prox Networkx PDLN4100/4500 also available**

School Lock-Down Applications: remain safely inside until the coast is clear – no need to open the door

At the first sign of trouble outside, with just one button and virtually no special training or knowledge required, faculty and/or students of all ages can simply press Trilogy's inside 'privacy' button to lock out unauthorized access, instantly locking-down a classroom or area, all while remaining safely within



the room. There is no need to open the door, nor use a special key, since the fingertip-activated button is located on the inside door, i.e., the same side as classroom occupants. Trilogy's lockdown function automatically disables free passage through the door and even locks out general PIN user codes, since routine Trilogy keypad access is temporarily suspended whenever the privacy button is activated (even when the lock is time-scheduled for free-access mode). *Instant lock-down override code*, will reactivate the pushbutton keypad and enable authorized teachers/staff, outside the classroom.

**For Keyfob Lockdown Trilogy, see DL2700LD pg. 2**

**For Global Lockdown from Server or any lock, see Trilogy Networkx pg 12-17**



# Trilogy Mortise: High security digital locks



## Trilogy® high security mortise locks with and without prox ID readers

### DL2700CR/DB T2 Series Mortise Locks

- Trilogy T2 Keyless Access Lock for mortise door prep
- High security mortise locking
- Fingertip access and programming flexibility
- Weatherproof for use inside or out
- 1-3/8" mortise cylinder included
- Choice of classroom or deadbolt functions & finishes
- Long battery life

### DL3500 Series Mortise Locks

- 300 User codes: Master, manager, supervisor & basic users
- Fingertip or Windows PC-programmable
- Real time clock enables up to 150 scheduled events and holiday schedules
- 40,000 Event audit trail provides a printed time/date- stamped log of all electronic activity
- Long-life battery pak for 80,000 cycles, typical and low-battery alert
- Choose either classroom or deadbolt versions and left or right handing (If reverse hand is required, lock is field reversible.)
- 1 3/8" (3.5 cm) mortise cylinder supplied card enrollment mode allows many cards to be quickly added without PC –also– downloadable from PC or prox enroller tool
- 40,000 event audit trail log
- 150 scheduled events, e.g., lock or unlock
- PC programming/reporting
- Quick passage mode (without being in program mode)

- Program data transferred to lock via AL-PCI2 or AL-DTMIII
- 5AA battery-pak operated; 75,000 cycles, typical
- 3 Architectural finishes (US3 polished brass, 26D satin chrome, 10B duronodic)
- Weatherproof -31° to +151°F (-35° to +66°C)

### PDL3500 Series

#### PDL3500 Series mortise lock with built in HID prox reader, similar to DL3500 Series, but with:

- 2000 user codes (3-6 digits) and/or HID prox cards/fobs
- 500 scheduled events, e.g., lock or unlock
- Multilevel security - Master; manager; supervisor; basic users
- Easy Tap & Add batch prox ID card enrollment mode allows many cards to be quickly added without PC –also– downloadable from PC or prox enroller tool
- PC programming/reporting
- Quick passage mode (without being in program mode)
- Program data transferred to lock via AL-PCI2 or AL-DTMIII
- 5AA battery-pak operated; 75,000 cycles, typical
- 3 Architectural finishes (US3 polished brass, 26D satin chrome, 10B duronodic)

Turn Standalone Trilogy Locks into Wireless Networked Network Locks with Field Upgrade Kits for Standalone PIN or PIN/Prox Cylindrical or Mortise Models. P/DL6100 and P/DL6500 upgrade kits available. iClass available – PDL8200 upgrade kit.

# Trilogy Exit: Add audit trail to panic exits

Add Trilogy convenience, programming, flexibility and audit trail to exit devices from most major manufacturers



## OUTSIDE:

Rugged, field-proven Trilogy digital lock.

## INSIDE:

Existing exit device – Most major brands supported



Add Trilogy convenience, programming, flexibility and audit trail to exit devices from most major manufacturers

### Trilogy Exit – ETDL, ETPDL

- Clutch Mechanism insures long life and durability
- Fingertip and/or Windows Programmable
- 2000 User Codes: Master, manager, supervisor and users
- Real Time Clock for up to 40,000 Event Time/Date-Stamped Audit Trail
- Up to 500 Lock/Unlock Schedules (with Time Zone Support)
- Rugged 12-Button Metal Keypad
- Non-Handed; Fully Field Reversible
- Adaptable to most major manufacturers of standard RIM and IC RIM Cylinders
- Supports most push in style panic exit devices including: Von Duprin 99, Marks USA M9900, Corbin ED5000 & Yale, Dorma 9300, Arrow 3800, Hager 4500, Old Style Sargent, New Style Sargent, Precision 1100, Cal Royal 9800, etc. (Consult factory for full list)
- Battery operated; uses 5 AA batteries

**Also available in prox model for added convenience and security. Includes all of the features above plus:**

- Accepts most HID Proximity cards and keyfobs
- Users are individually programmed to use a card only, code only, or for highest security – both card and code
- Prox card data can be added to software by uploading from lock, by using AL-PRE or entering directly from computer using DL-WINDOWS software.

**Also available in prox only model (ETPL)**

### ETDL2700 T2 Exit Trim

- As above but with T2 Trilogy features

# Trilogy Narrow Stile: Glass door retrofit

Now get convenient keyless PIN code or Prox access anywhere there's a glass door.

Trilogy Narrow Stile lever models (left and right) designed to work with Adams Rite® latch series; Thumbturn models (shown at center) support swing & hook bolt products .

Plus, PC-programmable 1300 Series models provide audit trail log of door users.



## Pushbutton aluminum door trim retrofit glass doors with latch locks

### DL1200, DL1300

- Add keyless convenience to mechanical latch locks from Trilogy's all-metal, vandal-resistant 12-button keypad and/or automatic timed-scheduled locking/unlocking and audit trail with 1300 Series
- Aluminum door retrofit outside trim for Adams Rite® 1850, 1950, 4710, 4070\*, 4730, 4900 Series and MS1850S\* and MS1950S\* Series latch locks
- DL1200 supports 100 3-5 digit PIN user codes, fingertip programmable
- DL1300 (and Prox PDL1300, right) support 2000 users, PC programming/reporting and features 40,000 event audit trail by user and 500 event schedule/real time clock (e.g. lock/unlock by time)
- Weatherproof -31° to +151°F (-35° to +66°C)
- Long-life, battery-operated for 100,000 and 80,000 cycles respectively, typical on 2 lithium 3V batteries, supplied; low battery alert
- Compact styling 14-3/8"H x 1-5/8"D x 1-3/4"W
- Key override mortise cylinder, 1-1/4" supplied. (Supports 1-1/8", 1-1/4" and 1-3/8"). Also interchangeable cores supported (Corbin/Russwin, Yale, Schlage, Medeco.)
- Backsets 31/32", 1-1/8" and 1-1/2"; Stile thickness 1-3/4"
- Non-handed; fully field-reversible
- Two finishes US26D satin & 10B Durondic

\*The 4070, MS1850S, and MS1950S only work with knob (50) or thumb turn (25) models.

## Narrow stile prox ID card PC-programmable model with audit trail

### PDL1300

Includes all of the 1300 Series features, at left:

- Built-in HID prox reader, supports up to 2000 users with HID Prox ID cards or/fobs or 3-6 digit PIN codes
- Easy Tap & Add batch prox ID card enrollment mode allows many cards to be quickly added without PC –also– downloadable from PC or prox enroller tool
- 40,000 event time-/date-stamped audit trail by user
- 500 event schedule/real time clock (e.g. lock/unlock by time)
- Long-life, battery-operated for 65,000 cycles, typical on 2 lithium 3V batteries, supplied; low battery alert



Ideal for universities, hospitals, laboratories, airports, office buildings & retailers



# Narrow Stile Exit: For aluminum door retrofits

## Alarm Lock's Trilogy narrow stile exit device trim locks

### DL1200ET Trilogy T2-platform

- Adds vandal-resistant keyless access to panic exit doors
- Protects storefronts and managed properties 24/7
- 100 users supported (3-5 digit codes)
- Designed with all-metal, vandal-resistant 12-button keypads
- Supports 3-6 digit PIN codes and multilevel user hierarchy
- Easily installs on most aluminum glass doors
- Works with Marks USA M8800, Jackson, Dor-O-Matic, Von Duprin (Von 33 LH (RHR) only), Dorma, Arrow, DCI & Corbin panic devices (Dor-O-Matic, Jackson and Dorma devices require thumb-turn or knob Note: Must purchase separate TP assembly – See price book).

### DL/PDL1300ET

As above but also equipped with ID card prox reader (PDL version), PC programming and automatic lock/unlock scheduling and time zone support

- 2000 Users (PIN code or prox ID on PDL model)
- Two finishes 2 Architectural finishes (26D satin chrome, 10B duronodic)

### Exit Devices TP Kits (Must order TP Kit Separately)

- Marks USA M8800
- Jackson 1095
- Dor-O-Matic - 2090
- Von Duprin 22
- Von Duprin 33 LH (RHR) only
- Dorma - 5300
- Arrow - 51200/51250
- DCI - 1200/1300
- Corbin - ED8200

**Note** - Certain manufactures' exit devices such as Jackson, Dor-O-Matic, DCI and others require a greater degree of rotation so a knob (50) or Thumb Turn (25) is required to retract and project the latch. In this function, the latch will remain retracted until a PIN or Prox Card is represented to project the latch creating a hold back feature. please contact your local Alarm Lock representative for additional information.



## Trilogy® Weatherproof Keypads: 12/24VAC/DC digital access keypads with PC programming & audit trail

### Trilogy DK3000 (shown, left)

- 2000 PIN user codes, multilevel security
- Ideal for use with 12V or 24V (AC or DC) electric door strikes, mag locks or Alarm Lock Remote Release Mag Lock Kit (adjacent page)
- Wall mount or single gang box
- 2 High-Current Rated 8A Relays for entry, alarm zone shunting or lock release by real-time schedule
- Vandal-resistant, all metal 12-button keypad
- Keypad or PC programmable
- 40,000 Event audit trail report/print to PC or hand held printer or DTMIII Data Module
- Timed Egress Input – Selectable door open times 3, 10 or 15 seconds
- 500 Scheduled events & real time clock
- Tamper supervised (reportable to alarm system)
- Remote release feature; request-to-exit input
- Weatherproof -31° to 151°F (-35° to +66°C)

## Digital access keypad with prox reader

### Trilogy PDK3000 (shown, right)

Same features as DK3000 above, plus

- Built-in HID proximity reader
- Accepts up to 2000 PIN codes and/or HID cards and keyfobs



For Wireless Keypad Solution, Ideal for use with Mags, Strikes and Electrified Exit Devices - Please also see Networkx Keypad & NetPanel pgs 12-13

Ideal for elevators and gate applications

# Trilogy Ordering Information

## Choice of three standard Trilogy finishes



US3  
Polished Brass



US26D  
Satin Chrome



US10B  
Duronodic

## U.S. Handing options



00 Straight Lever



75 Regal Curved Lever



25 Turnpiece  
50 Knob available on  
DL1250/1350

## DL-WINDOWS Trilogy Software

Free Alarm Lock Trilogy Microsoft Windows-based software application, for programming, entering users, receiving audit trail from lock or used with ALDTMs to transfer data. Version.4.177 or higher, supports Trilogy Networkx, Wireless Keypads, Locks and ArchiTech series, and Trilogy standalone locks, with single database. Downloadable free at [www.alarmlock.com](http://www.alarmlock.com). For enterprise network software options, and real-time performance, see pg.15



## Trilogy audit trail and programming

### AL-IR1 Infrared Printer

Prints the event log and user code with hand-held convenience.



### AL-DTMIII Data Transfer Module

Module used to transfer program data from the PC to the lock and receive Audit Trail from the lock. Can transfer program data for up to 200 locks.



### AL-PRE2 Dual Function Reader/Enroller for Smart Cards or Prox IDs

Just tap the Smart Card or Prox ID device to the unit's faceplate to automatically enroll in DL-WINDOWS software database. (USB)



### AL-PCI2U Lock / PC Interface (shown)

Interface cable interconnects lock and PC for data transfer with USB interface cable. (AL-PCI also includes DL-WINDOWS CD). Also available AL-PCI2 w/o USB.



## Remote Release Kit

### RR-TRILOGYKIT

Remote release kit for all Trilogy Cylindrical models includes the **RR-1BUTTON** for desk mount applications and **RR-RECEIVER** for installation inside the battery compartment of any cylindrical Trilogy lock (Simply connects to the 2 white remote release wires inside. Retrofits any existing cylindrical Trilogy manufactured since 2000.



Also available for Mortise and Exit Trim models, **RR-MORTISEKIT** and **RR-EXITTRIMKIT**, respectively. (Note: individual kit components, in blue, are also separately available.) Retrofits units with serviceable battery pack (2000 and up year built)

## Cylindrical Trilogys

DL 27 00 WP IC /26D -Y

### Model/Series:

DL27 = DL2700 Series  
DL28 = DL2800 Series  
DL30 = DL3000 Series  
DL32 = DL3200 Series  
DL52 = DL5300 Series  
PDL30 = PDL3000 Series  
PDL53 = PDL5300 Series

### Network Wireless:

DL6100 PIN Series;  
PDL6100, 8200 PIN/Prox

### Trim:

00 = Lever  
75 = Regal Curved Lever

### Exterior/Interior Use:

For Exterior use of DL2700 & DL3000 only, order WP for weatherproof use. All other models are weatherproof as standard.

### Cylinder:

IC = Standard Interchangeable Core Prep for Best, Falcon, Arrow, KSP  
(Note: No "IC" indicates standard K.O. cylinder.)

### Finish:

/3 = US3 Polished Brass  
/26D = US26D Satin Chrome  
/10B = Duronodic (Special Order)

### Special Order IC Prep:

-Y = Yale  
-M = Medeco  
-R = Sargent  
-C = Corbin/Russwin  
-S = Schlage

## Mortise Trilogys

DL 35 00 DB R /26D EX

### Model & Series:

DL35 = Trilogy T3 Mortise Series

### Network Wireless:

DL6500 PIN; PDL6500 PIN/Prox

### Trim:

00 = Standard Lever  
75 = Regal Curved Lever (U.S. Option Only)

### Lock Body:

DB = Dead Bolt  
CR = Class Room (U.S. Only)

### Handing:

Your Door -	Order -
Left Handed	L
Right Handed	R
Left Hand Reverse Bevel	R
Right Hand Reverse Bevel	L

### Finish:

/3 = US3 Polished Brass  
/26D = US26D Satin Chrome  
/10B = Duronodic (Special Order)

### European Model Suffix

Not Used For U.S. Models  
\*Note: Standard Lever for U.S. Models is Straight Lever.  
Standard Lever for European Models is Curved Tubular Lever

(Note: Trim is non-handed. Lock body is field reversible.)

## Trilogy Narrow Stile

DL1200/26D1

### Model Type

PDL - Prox/PIN  
DL - Digital PIN

### Trilogy Series

12 - 2700 Series  
13 - 3000 Series

### Trim

00 = Lever  
25 = Turnpiece  
50 = Knob  
75 = Regal lever

### Finish

/26D Satin Chrome  
/10B Duronodic  
/MS Metallic Silver  
/MB Metallic Bronze

### Mechanical Dead Latch

1 - Supports Adams Rite:  
4710, 4730, 4900 Series  
2 - Supports Adams Rite:  
4070, MS1850S,  
MS1850S-050, MS1950,  
MS1950-050

## Trilogy Exit

ETPDL- 1 R/ 26D V99

### Type:

PDL = Digital with Prox  
PL = Prox Only  
DL = No Prox  
N = (suffix) Network Wireless

### Door Thickness:

1 = 1 3/4" + 1/8"  
2 = 2" to 2 3/4"  
3 = 3" to 4"

### Handle:

R = Regal  
S = Straight

### Finish:

/3 = US3 Polished Brass  
/26D = US26D Satin Chrome  
/10B = Duronodic (Special Order)

### OEM Trim

M99 = Marks USA M9900  
V99 = Von Duprin 99  
C50 = Corbin ED5000 & Yale  
D93 = Dorma 9300  
A38 = Arrow 3800  
S88 = Old Style Sargent  
N58 = New Style Sargent  
P11 = Precision 1100  
CR8 = Cal Royal 9800

# Wireless Networkx Keypad Solution: Trilogy

## EASY NETWORKX WIRELESS KEYPAD SYSTEM

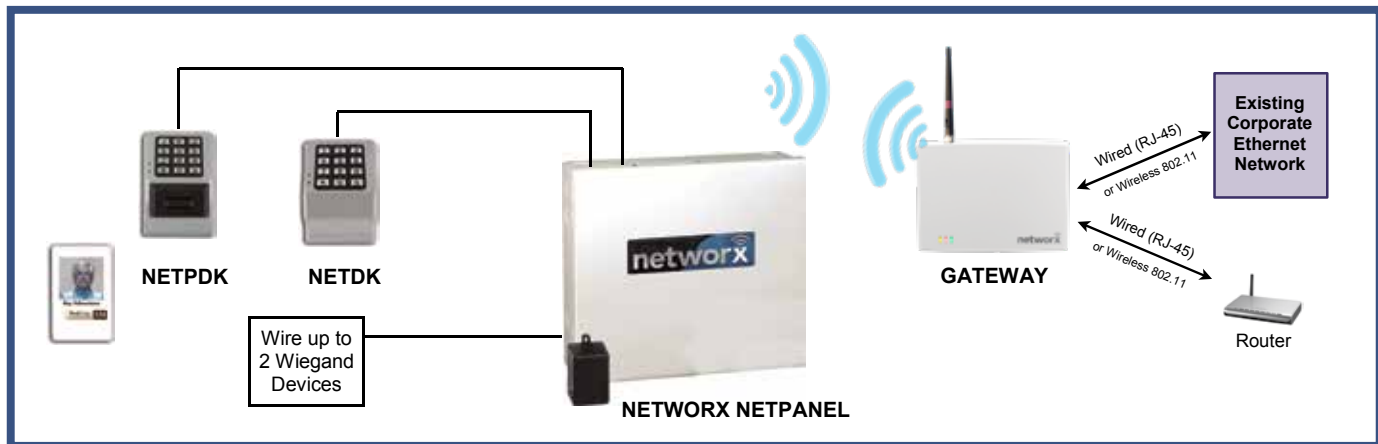

**NET-DKPAK & NET-PDKPAK**

**Trilogy Networkx Wireless Keypads and NetPanel combine to provide the ideal wireless keypad solution for use with mag locks, strikes and electrified exit devices in a smart access system** with advanced features & functions, like automatic schedules, event logs and support for 2000 doors and 5000 existing Prox. ID Cards/Badges. The Networkx Panel communicates via a Networkx Gateway networked to any Windows-based PC. Networkx keypads seamlessly share one common database hosted on free Alarm Lock free software (along with Networkx locks and standalone Trilogys too.). This cost effective system is very scalable, and up to 63 NetPanels,

controlling up to 126 Networkx Keypads (or Wiegand devices), can communicate to as little as one Alarm Lock Gateway. Two starter kits are available, NET-DKPAK & NET-PDKPAK, each with a controller and keypad (Digital PIN or Prox, respectively). Additional keypads and NetPanels may also be purchased individually.

### Advantages

- **Wireless Keypad solution** - networked versions of popular Trilogy DK/PDK3000 Keypads
- **Ideal for use with strikes, mags, electrified exit devices**
- 5000 users with 3-6 digit PINs or HID® ID cards
- **Save manpower - Bidirectional 128 AES encrypted network communications** updates, users, time-schedules and audit trail queries — without ever going to the keypads

**Versatile for indoors and outside; ideal for education, healthcare, government, airports, courts, municipalities, & retail**

- **Familiar Trilogy operation,** programming, software and ruggedness
- **NetPanel Controller supports 2 Networkx keypads and/or 2 Wiegand output readers /devices**
- Key features: Global lockdown and passage from keypad or PC, schedules, 35K event log, door position status indicator, request-to-exit, door ajar/kick-in, remote release options.

### Features

- Networkx NetPanel supports up to 2 Networkx wireless keypads and/or Wiegand-output readers and communicates wirelessly via Ethernet or 802.11B/G for a comprehensive wireless networked door access control system, eliminating door-to-door programming and audit trail retrieval and providing all standalone Trilogy lock functionality plus new network-wide global emergency lockdown/unlock commands
- Networkx Keypads support up to 5000 users with 3-6 digit numeric PIN codes and NETPDK-Series also support prox ID card users (virtually all HID format proximity technology ID cards, fobs, credentials.)
- System-wide free-passage enable or disable, can be activated from the keypad or the Networkx PC
- On demand, in seconds, wirelessly change keypad users, schedules, features or retrieve 35,000 events from any networked PC.
- Ideal for use with mag locks, strikes and electrified exit /panic devices (EL-devices/ electrified latch retraction devices.)
- Free Alarm Lock DL-WINDOWS software doesn't require a dedicated computer or a special computer network or costly server software licenses, it simply runs as a secure Microsoft Windows-based application, on any computer system (as basic as a desktop or laptop PC), a wired or wireless router, and a gateway module or on an internal LAN with static IP address (recommended).
- Up to 2000 NetPanels can be used per account to further expand system capabilities.



# Networkx Keypads & NetPanel

## NETWORKX KEYPADS use with Mag Lock, Electric Strike or Wiegand Devices – Control up to 2 Doors

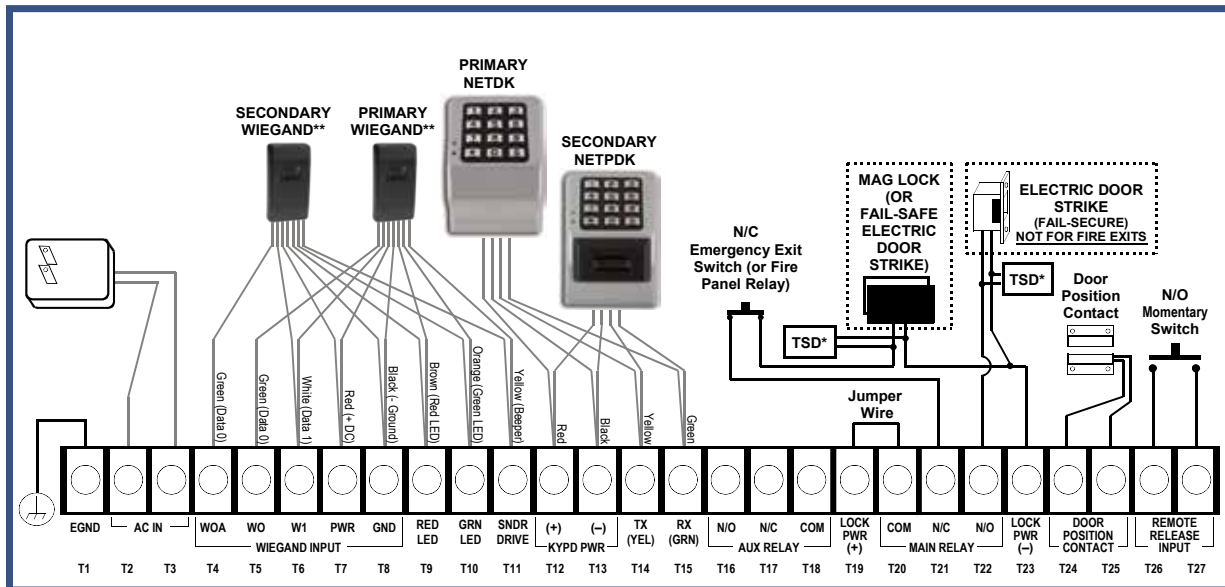

The system is capable of controlling two doors using up to two of any combination of NETDK or NETPDK keypads, PLUS up to two Wiegand devices. Two auxiliary Form-C relays are available for up to two of any combination of magnetic locks and/or electric door strikes.



### NETPANEL dedicated access panel Includes

- Circuit board with onboard flash memory; 12V power supply, with transformer and rechargeable backup battery
- Inputs supporting two of any combination of NETDK or NETPDK keypads, PLUS up to two Wiegand devices
- Special "Two Door Mode" allows two keypads and/or two Wiegand devices to separately control two doors
- Two Form-C relays
- Inputs for door position contact to indicate the status of the door, open or closed;
- Inputs for a remote release button or sensor
- Onboard bi-directional Networkx radio
- Wiegand interface, red LED, green LED, and sounder.

### Wiegand Device Support

- The NetPanel's Wiegand inputs currently support all Wiegand output devices, that support the Data 0/Data 1 communications protocol and are compatible with HID Prox credentials (including Wiegand keypads and combination units.)

### Examples of Wiegand Devices Supported:

- HID Classic Swipe Wiegand Reader Model 310 (36-bit card format compatible).
- HID ProxPro with Keypad Model 5355
- HES model RF5910 Hybrid Electric Strike with HID125k reader

\*\*\* Other formats may be accommodated for special orders. Ask you Alarm Lock Representative.

### Ordering Info.

**NETPDKPAK26D** Complete 2-Door Net-Panel System with 1 PDK wireless keypad with built in HID Prox Reader, 26D finish. \*\*\*\* Includes 12 volt power supply, onboard bidirectional radio, 4Ah/12V rechargeable backup battery and plug in AC transformer. (System requires use of one of the AL-IM Series Gateway Modules, separately purchased.)

**NETDKPAK26D** Complete 2-Door Net-Panel System with 1 DK wireless keypad, 26D finish. \*\*\*\* Includes 12 volt power supply, onboard bidirectional radio, 4Ah/12V rechargeable backup battery and plug in AC transformer. (System requires use of one of the AL-IM Series Gateway Modules, separately purchased.)

**NETPDK26D** PDK Wireless Keypad with built in HID Prox Reader only, 26D finish. \*\*\*\*

**NETDK26D** DK Wireless keypad only, 26D finish.

\*\*\*\*Note: Special keypad finishes may also be available – ask your Alarm Lock Rep.

**NETHIDNSPAK** Networkx Narrowstle Prox point reader, control panel w/door position switch with RX, remote release and battery backup plus plug-in transformer.

**NETWORKPANEL** Access Control Panel to be used with other approved Wiegand output readers. Includes 12 volt power supply, onboard bidirectional radio, 4Ah/12V rechargeable backup battery and plug in AC transformer.

### Networkx Series Accessories

#### AL-NSG Gateway Simulator

A portable battery powered Networkx Gateway simulation device that generates continuous Gateway radio signals to a Networkx Signal Meter.



#### AL-NSM Site Survey Tool for Networkx Gateways

Performs a site survey test of the premises to find optimum location of Networkx gateways and locks. Also helps to determine the number of gateways required to cover the signal area of the Networkx locks you plan to install.



# Wireless Networkx Locks: Easily-networked access locks



# networkx

by Trilogy

## Networked Wireless Access Control that's ½ the cost of a hardwired system, now for every door & application

Based on Trilogy®, the #1 electronic standalone access locks, Networkx™ Locking Products are networked to save staff labor, eliminating door-to-door programming and audit trail retrieval, by communicating wirelessly via Ethernet or 802.11B/G, all while providing the ultra dependability, functionality & long battery life, original Trilogys are known for. The expanded Networkx line, for every type of door, combines to provide a quick, easy, economical access system for up to 2000 doors and 5000 users, with advanced features & functions, e.g., automatic schedules, event logs. But, with no wires to run, and no access panels or power supplies to buy or install, it can be a great time and budget saver for buildings, campuses or office suites. At its simplest, it's one Grade 1 wireless lock per door, installed in about an hour, all communicating to a single Gateway (your choice of gateways controls up to 63 locks), networked to any non-dedicated Windows-based PC. In addition to Wireless Trilogy Networkx' unsurpassed battery-life, exceeding 5 years, they feature new network-wide capabilities, executed from any lock or the network's PC, including emergency priority global lockdown deployed in seconds, and you can activate (non-priority) system-wide free-passage or locking modes from the PC. For existing Trilogy installations, original standalone and new Trilogy Networkx locks can seamlessly share one common database hosted on free Alarm Lock DL-WINDOWS software. For real-time access applications, Networkx Locks offer enterprise network integration with several leading platforms.

- **Trilogy Networkx Locks communicate wirelessly via Ethernet or 802.11B/G** for a comprehensive wireless networked door access control system, eliminating door-to-door programming and audit trail retrieval and providing all standalone Trilogy lock functionality plus

new network-wide and emergency lockdown features

- **Unsurpassed 5-year+ battery life, typical**, (Automatic battery status reports at the PC; visual and audible low-battery status indicators at lock(s).)
- **Trilogy Networkx and gateway modules have an integral transceiver for highly-efficient 900MHz bidirectional communications**, for longer range and less interference than with more common 2.4GHz spread spectrum devices. Alarm Lock devices require NO wiring; NO splitters or repeaters; NO hardwiring to the host/server; NO extra power supplies; and NO access controller/panels.
- **In 10 seconds, activate emergency global lockdown from the Networkx PC, any Networkx lock or Keyfob (RR-4BKEYFOB)**. (This priority emergency command is lightning-fast system-wide and supersedes all scheduled programs or updates, etc. However, if desired, locks may be selectively programmed to be excluded from emergency global lockdown function, i.e., they will ignore the command.)
- **System-wide free-passage enable or disable**, can likewise be activated from the Networkx PC
- **Locks easily retrofit standard or any Networkx locks and support up to 5000 users with 3-6 digit numeric PIN codes and PDL-Series also support prox ID card users** (virtually all HID™ format proximity technology ID cards, fobs, credentials.)
- **On demand, in seconds, wirelessly change users, schedules, lock features or retrieve audit trails of up to 40,000 events/lock from any networked PC**. (Note: Transaction processing time is dependent upon system capacity, the more locks/gateways and the more data to be up/downloaded, the longer the time.)

# Wireless Networkx Locks: Easily-networked access locks

- **Unattended programming updates or event log retrievals can be scheduled** to run automatically, saving manpower and productive time.
- **Seamless upgrade path for original Trilogy users:** Intermix with existing Trilogy standalone lock installations and share one database and familiar Trilogy lock and software functions: Trilogy Wireless Networkx Locks seamlessly integrate in an existing Alarm Lock Trilogy standalone door access system and share the same single DL-WINDOWS database (requires v4.1.x or higher). Existing Trilogy users can easily add one wireless Networkx Lock, or as many as two thousand, to an existing system seamlessly with no downtime.
- **Secure 128bit AES PC encryption and proprietary RF-link lock communication encryption** protects the system from interference or tampering (WEP or WPA compatible with wireless modem).
- **Remote System Management:** VPN-connection /remote capability for accessing the Networkx System and controlling up to all 2000 locks, with all the security and peace-of-mind of your IT network. (No special modems required.)
- **Wireless locks are fully keypad programmable** and can be up and functioning even before their wireless network is configured, so IT departments don't have to coordinate with physical security departments or locksmiths
- **Free Alarm Lock DL-WINDOWS software doesn't require a dedicated computer** or a special computer network or costly server software licenses, it simply runs as a secure Microsoft Windows-based application, on any computer system (as basic as a desktop or laptop PC), a wired or wireless router, and a gateway module or on an internal LAN with static IP address (recommended). (v4.1.x or higher).
- **Minimizing hardware & installation costs, a single gateway module can interface between the PC network and up to 63 Networkx locks**, with a clear field range of up to 500 feet and 150 feet in buildings. At its maximum, a Trilogy Networkx system can comprise up to 50 gateways for the networking of up to 2000 locks or access controlled doors. New Gen 2 Gateways & Expanders for easiest networking (see pg 17)
- **Wall- or ceiling-mountable, compact gateway modules are available in wireless/hardwired and wired-only versions** (with Power Over Ethernet (POE) option). The hybrid model connects using either 802.11, Ethernet cable or 100Base-TX (using RJ45 Jack); the wired versions use an RJ-45 Ethernet cable. Networkx communications support both wired Ethernet 10BaseT and wireless 802.11.
- For the fastest most reliable networked system, in discovery setup mode, the system will locate and DL-WINDOWS will display each lock's signal strength at each installed



*Up to 2000 locks and a PC communicate wirelessly through bidirectional Gateways – eliminating the need for door-to-door programming and audit trail retrieval.*

*In seconds, global lockdown can be implemented from any Trilogy lock or the DL-WINDOWS computer.*

gateway, so you can select it and optimize reliable communications and eliminate guesswork.

- Lock programming, user- and usage-data are stored locally at the battery-powered lock for uninterrupted door access usage in a power outage or server offline situation.

## Enterprise Networks, Real-Time Performance

- Networkx locks can be used as wireless, single-door controllers in real time too
- Use with Continental Access®, CA4K®, Lenel OnGuard® Integrated Access Control & Video Security or Software House Connect Partner® Program Platforms ††



## Trilogy Networkx Lock Specifications:

- Weatherproof locks for indoor/outdoor use with wide operating temperature range (-31 to 151° degrees F).
- Cylindrical models boast industrial strength BHMA Grade 1 durability and all models feature vandal-resistant all-metal keypad for PIN codes.
- PDL versions, HID Prox. Reader.
- ADA-compliant leversets.
- Easy-to-install modified ANSI A115 Series door prep; easily and neatly retrofit standard cylindrical knobsets and mechanical standalone locks, in under an hour. Non-handed
- 3 hour UL fire-rated deadlatch.
- Supports 1-5/8 to 1-7/8" door thickness; 2-3/4" backset (2-3/8" available.)
- Manual key override standard; most IC cores also supported on interchangeable core models.
- Wide choice of 3 Architectural finishes (US3 polished brass, 26D satin chrome, 10B duronodic) and IC core preps (6-7pin).

## Network Interface

**INTERFACE:** Ethernet 10Base-T or 100Base-TX (using RJ45 Jack)

**PROTOCOLS:** TCP/IP, UDP/IP, DHCP 802.11 Wireless Specifications

**WIRELESS STANDARDS:** 802.11b; 802.11g

**FREQUENCY RANGE:** 2.412 - 2.484 GHz

**OUTPUT POWER:** 14 dBm + 1.5 dBm/-1.0 dBm

**MAXIMUM RECEIVE LEVEL:** -10dBm (with PER < 8%)

**DATA RATES WITH AUTOMATIC FALLBACK:** 54Mbps - 1Mbps

**RANGE:** Up to 328 feet indoors

**MODULATION TECHNIQUES:** OFDM, DSSS, CCK, DQPSK, DBPSK, 64 QAM, 16 QAM

**INTERFACE:** Wireless 802.11b, 802.11g and 10/100 Ethernet

**PROTOCOLS:** TCP/IP, UDP/IP, DHCP

## SECURITY

- IEEE 802.11 - PSK with AES Encryption 128-bit Encryption
- 128-bit AES Rijndael encryption

## AL Radio Link

- 900 MHz GFSK, 50 channels, 10mW power output

**VOLTAGE:** 5 - 6 volts AC/DC

**OPERATING TEMPERATURE:** -20° to 60°C (-4° to 140°F)

**STORAGE:** -40° to 85°C (-40° to 185°F)

## AVERAGE POWER CONSUMPTION:

- 1300 mW (WLAN mode; maximum data rate)
- 300 mW (WLAN mode; idle)
- 750 mW (Ethernet Mode)

**PEAK SUPPLY CURRENT:** 650 mA

**INPUT VOLTAGE:** 5 - 6 volts AC/DC

**OPERATING TEMPERATURE:** -31 to 151° degrees F

**STORAGE TEMPERATURE:** -40° to 85°C (-40° to 185°F)

†† **Important: For enterprise integration** consult technical documentation to match proper AL hardware (Gateways, Expanders, etc.) with enterprise software Versions supported.



# Trilogy Networkx: Wireless networked access for every application



## More Networkx Models & Options:

**PDL6100** Cylindrical Trilogy Networkx PIN/Prox. wireless access control lock with built in HID proximity ID card reader

**PDLN4100** As above, with privacy button on inner door

**DL6100** As above PDL6100, with full-metal digital keypad only

**PDL6200** Cylindrical Trilogy Networkx PIN/Prox. wireless access control lock with built in HID proximity ID card reader and Door Position Switch/Request to Exit feature

**PDL8200** As above, with HID iClass support

**PDL6500** Mortise Trilogy Networkx PIN/Prox. wireless access control lock with built in HID proximity ID card reader

**PDLN4500** As above but with privacy function via thumb turn on inner door (deadbolt only)

**DL6500** As above PDL6500, with full-metal digital keypad only

**PDL6600** Mortise Trilogy Networkx PIN/Prox. wireless access control lock with built in HID proximity ID card reader and Door Position Switch/Request to Exit feature

**PDL8600** As above, with HID iClass support

**PDL6300** Cylindrical Trilogy Networkx double-sided PIN/Prox. wireless access control lock with built in HID proximity ID card reader

**PDL1300NW** Networkx narrow stile wireless access prox lock trim with built in HID proximity ID card reader

**DL1300NW** As above, with full-metal digital keypad only

**PDL1300NWET** Networkx narrow stile exit trim with built in HID proximity ID card reader

**DL1300NWET** As above, with full-metal digital keypad only



Add Networkx Trilogy convenience, programming, flexibility, audit trail and wireless connectivity to panic exit devices from most major manufacturers

**ETPDN** Trilogy Networkx wireless access lock trim with built-in HID proximity ID card reader

**ETDLN** As above, with full-metal digital keypad only

**ETPDN-RX** Trilogy Networkx wireless access lock trim with built-in HID proximity ID card reader with Request to Exit feature

**ETPDNI-RX** As above, with HID iClass support

**NETWXSTARTER** Trilogy Networkx Wireless Access Control Starter Kit, contains 1 each PDL610026D, ALIME-2 Gateway, DL-WINDOWS and 30 HID cards

For a list of compatible exit trims, see page 8; for compatible wireless keypads see page 10

# Trilogy Networx: Gen.2 Gateways & Expanders<sup>‡</sup>



## AL-IME2 Gen. 2 Gateway

The Trilogy Networx AL Generation Gateway, interfaces Networx locks with a PC network via a hardwire Ethernet connection. It is very similar in function to the original hardwired

Networx Gateway Modules, but is enhanced with additional extended potential range, supporting up to seven (7) Expanders (model AL-IME2-EXP Expanders). Each Expander can extend the AL-IME2 Gateway's coverage area by approximately 100 feet. Also both Gen. 2 Gateways and matching Expanders have a new modern styling, and three LED indicators, blending into any décor.



## AL-IME2-POE Gen. 2 Gateway

The Trilogy Networx AL-IME2-POE (Power Over Ethernet) Hardwired Gateway interfaces Networx locks with a PC network with hardwire Power-Over-Ethernet. It is very similar in function to the original hardwired

Networx Gateway Modules, but is enhanced with alternative power, and additional extended potential range, supporting up to seven (7) Expanders (model AL-IME2-EXP Expanders).



## AL-IME2-EXP Expander

Trilogy® Networx™ Expander extends the coverage area of a Gen 2 Series Gateways to Trilogy Networx Locks within a PC network, allowing greater distances for the placement of up to a maximum rated capacity of 63 Networx locks per Version 2 Gateway.



## AL-IM2-80211

### Gen. 2 802.11 Gateway

Similar to model above, but this 802.11 Gateway Module includes a bi-directional radio, and interfaces Networx locks with a PC network with hardwire Ethernet and wireless 802.11. It is very similar in function to the original 802.11 Networx Gateway Modules, but is enhanced with additional extended potential range, supporting up to seven (7) Expanders (model AL-IME2-EXP Expanders).

Each Expander can extend the AL-IM2-80211 Gateway's coverage area by approximately 100 feet.



## AL-IME2-PIE Plug-in Expander

The Trilogy® Networx™ Plug-In Expander extends the coverage area of a Generation 2 Series AL-IME2 Gateway to Trilogy Networx Locks within a PC network, allowing greater 900MHz distances for the placement of up to a maximum rated capacity of 63 networx locks per Version 2 Gateway.

---

## iLock® App: Unlocks ArchiTech™ Bluetooth® Series Door Locks in seconds!



Introducing iLock®, the easy smartphone mobile solution for unlocking your ArchiTech™ Series Designer Access Control Locks from any smart device without the need to carry cumbersome ID cards or keys. Password protected access is secure through the use of Bluetooth LE™ and proprietary encryption. Additionally, an optional feature can be utilized, requiring a password for each unlock request.

### The Key is Your Smartphone & More Secure Technology

Any Smart Device can be the Access Key: Much more than an ID card displayed on your



smartphone, for your security, ArchiTech & its iLock App are wirelessly linked together, each

supplying its portion of stored encrypted data to provide secure access without a key, fuss or worry, ensuring user identities. A unique combination of convenience and cloneproof peace of mind, the ArchiTech platform uses universally-compatible Bluetooth LE technology, so they can use any smart device to unlock ArchiTech on your door(s); and do so from afar, at a comfortable, customizable range of up to 30 feet away. For even greater security users can add an optional passcode, entered on their phone App. Coming soon: emailable digital eKeys for guests or service temporary access, too.

*iLock App is available from both iTunes and the Google Play Store*

# Networx ArchiTech: Designer Wireless Access Control Platform



**ArchiTech Series Networx Locks are an ideal access control solution; elegantly blending advanced wireless access control convenience within any décor, in an attractive, infinitely customizable designer locking form factor, in choice of trims and finishes.** Ideal for educational, commercial office or multi-dwelling residential settings, these stylish, durable locks, leveraging proven Networx access control technology, offer a choice of ID credential technology, and can be used to control access a door at a time; across a wireless network; or as an integral part of a new or existing enterprise security system—spanning a few, or thousands of doors, in one building, a campus or multiple sites around the world.



## Performance Overview

- **All Applications and Doors** - Cylindrical and Mortise models for wood and metal doors, for new and existing applications, with wireless surface mount or mortised-in electronics and batteries.
- **Customize To Match Any Aesthetic Look, For Every Décor** - Over 300 locks, levers, roses and finishes to choose from, durable ANSI/BHMA Grade 1 hardware over 300 locks, levers, roses and finishes
- **Future-Proof Multi-Technology Access ID Credentials Replace Cumbersome Keys** – HID® Prox, Mag Stripe, Smart Cards, PIV, keyfobs and remote buttons
- **Emergency Lock-Down** option via lock, button, keyfob or server (where networked). (Global Unlock via server too.)
- **Proven, Low Maintenance, Wireless Installation And Unsurpassed Battery-Life with Advanced Power-Saver circuit**, with years of use in even high-traffic areas, using off-the-shelf AA batteries.
- **Flexible System Programming** Locally using a USB Gateway or remotely across a wireless network (using free Alarm Lock DL-WINDOWS Windows-based software) or integrated on an enterprise class IT environment, in realtime, using LENEL
- **Networking Choices** – Choose 802.11 or Ethernet network, with wireless encrypted bi-directional gateways, in which many locks communicate to a single gateway, expander, or use a wireless RF USB Gateway equivalent. For entry door applications and the like, used in conjunction with strikes and mags, use with Networx NetPanels. Or, use as a single-door control, in real time, as part of the IT-Network environment, with Continental Access CA4K®, Lenel OnGuard® Integrated Access Control & Video Security or Software House Connected Partner Program® Platforms.†



## Standard Configurations

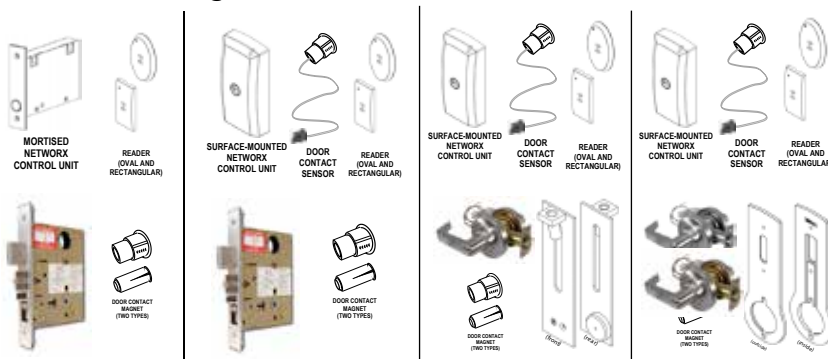

### Features:

- 5000 Users, 500 Scheduled Events & 40,000 Event Audit Trail
- Surface-Mount or Mortised-in Electronics and Battery Pack
- Lock available in Mortise and Cylindrical versions
- Real Time Clock
- Uses 4 AA Batteries – 3 year battery life, typ. using advanced Power-Saver circuit
- Operated via access card, keyfob or bluetooth enabled iLock® App.
- DL-Windows Software for programming Or in enterprise network, in real time, use with Continental Access® CA4K®, Lenel OnGuard® Integrated Access Control & Video Security or Software House Connected Partner Program® Platforms
- USB Radio Gateway Method or Via Networx Gateways (Ethernet, 802.11 or POE)
- Manual Card Enrollment Option for Quick Installation
- Wireless programming range: up to 100 ft.
- ANSI / BHMA Grade 1 Certified, UL Listed 3 Hours
- Auto-Deadbolt option for automatic keyless locking of deadbolt upon exiting, ideal for residential applications
- Includes standard lever rose hardware design
- Mortise version compatible with all 300+ optional architectural trim / lever or knob designs
- Stainless steel latch, 2-3/4" backset
- Auto-Reverse lock body tested to 6 million cycles
- Lock Body - Self cleaning long life motor
- Door closure monitor / electronic deadbolt monitor
- Key override standard or high-security
- Optional integrated door position indicator switch



# ArchiTech: Standalone or Networked Access

## ArchiTech N90L: Ideal for school & campus safety



**LocDown Keyfobs** - Staffers lock down one, or all networked doors in seconds



Lockdown Strobe Indicator flashes to confirm lock is in secure, lockdown mode



Choice of access ID credentials replace cumbersome keys



- **Designer Wireless Access Control Networked Locks** include multi-technology ID reader access control convenience for any door and decor, with choice of handles, finishes and reader shape
- **Easily, securely networked via 802.11 or ethernet**, spanning a few or thousands of doors, in one building, a campus or multiple sites in an enterprise (also available in standalone model)
- **Emergency LocDown Keyfobs & Flashing Strobe Indicator** - In emergency, lockdown one or multiple locks globally with remote pocket sized keyfob. Lockdown indicator vividly flashes on the inside door, confirming lock activation and providing peace of mind to occupants
- **Programmable Lockdown/Unlock Privileges** - For added security, programmable user privileges can be varied by group, i.e., all users can be given global lockdown privileges, while only select users can have both lockdown & unlock privileges, etc.
- **Cylindrical ArchiTech Locks neatly, quickly retrofit any standard door lock, with easy surface mount electronics, for use in all applications** - Including wood and metal doors, for new and existing applications
- **Customizable** oval or square Access ID Reader, in black or silver and three levers to choose from - American 195, Crescent 295 & Titan 495 - See lever photos on back
- **Future-Proof Multi-Technology Access ID Credentials Replace Cumbersome Keys** - HID\* Prox, Mag Stripe, Smart Cards, PIV, keyfobs and remote buttons

- **Proven, Low Maintenance, Wireless Installation and Unsurpassed Battery-Life with Advanced Power-Saver circuit**, for years of use in even high-traffic areas, powered by 4 off-the-shelf AA Batteries. 3 to 4 years, typ.
- **Flexible System Monitoring, Control & Programming** - Program locally using a USB Gateway or remotely across a wireless network (using free Alarm Lock DL-WINDOWS Windows- based software). **Or, in Real-Time Enterprise platforms**, using either Continental Access CA4K\*, Lenel\* OnGuard\* or support via Software House\* Connected Partner Program\*



- **Minimizing hardware & installation costs, a single gateway module can be placed anywhere in any size network and interface between the PC and up to 63 Network locks.** At its maximum, a ArchiTech Network system can comprise of up to 50 Gateways for the networking of up to 2000 locks or access controlled doors
- **Compact LocDown Keyfob** - Program up to 10 keyfobs per lock. For added security, program different users for global lockdown & unlock privileges
- **Up to 5000 users/ credential holders, 500 Scheduled Events & 36,000 Event Audit Trail**
- **Non-handed** for easy installation and versatility

## ArchiTech Lock Designs



Concealed electronics



Mortised-in electronics and batteries



Cylindrical; Surface Mounted Electronics (back box not shown)



Mortise; Surface Mounted Electronics



Mag Reader



Keypad

# ArchiTech Ordering: Infinite Grade 1 Trim Options



Standard Model Ordering. Infinite Custom Models Also Available, Call for Ordering Assistance

BASE DISTRIBUTION MORTISE MODEL P/N SCHEME

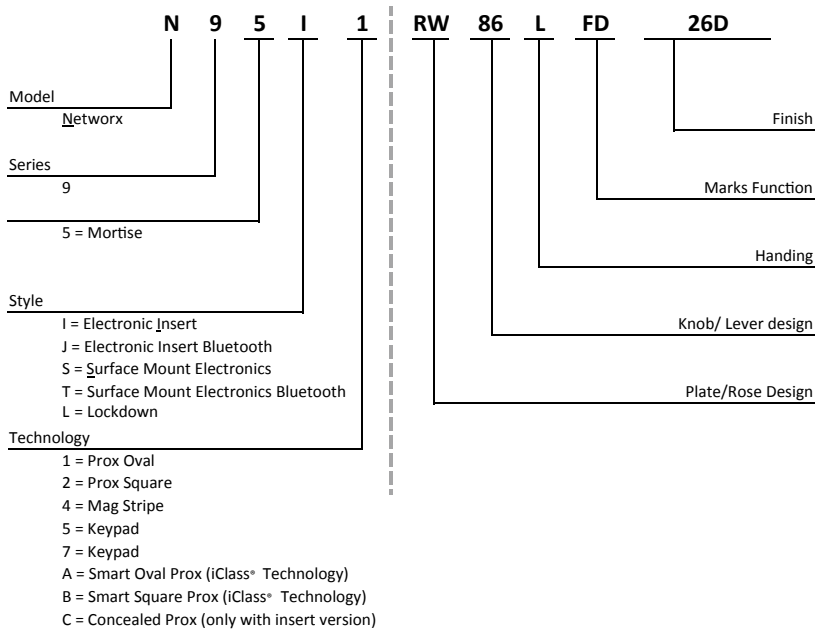

BASE DISTRIBUTION CYLINDRICAL MODEL P/N SCHEME

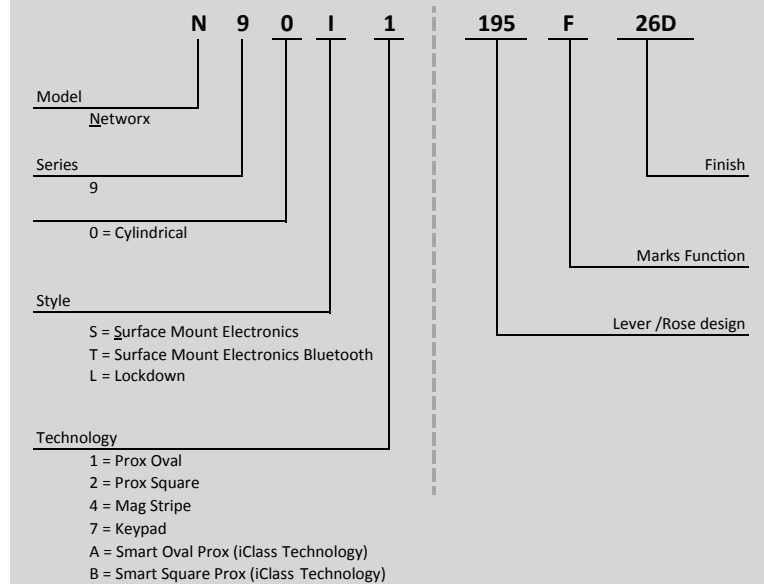

**ArchiTech: Hundreds of Options for ArchiTech to be Customized. Select Standard Mortise & Tubular Lock Trim & Rose Options:**

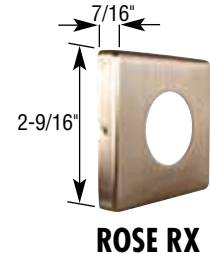
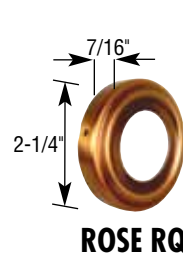
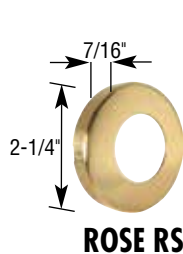
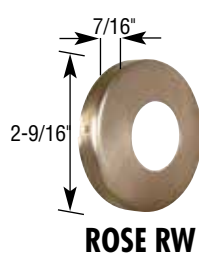
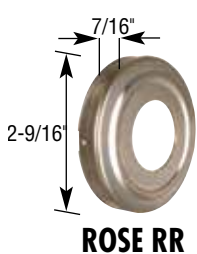

# Some Designer Custom Options for ArchiTech

## Select Standard Mortise & Tubular Lock Trim Options:



**ROUND 10**

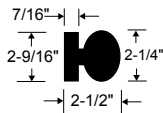

**STANHOPE 5644**

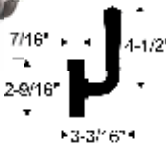

**PLAZA 82**

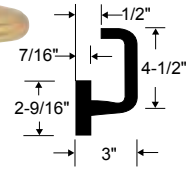

**BALL 20/30**

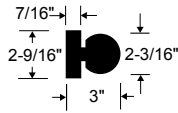

**MONACO 57**

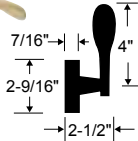

**DAYTON 83**

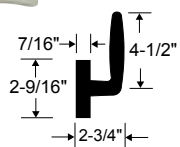

**ECLIPSE 60**

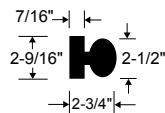

**TOWNE 72**

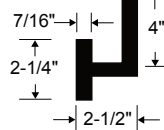

**CRESCENT 86**

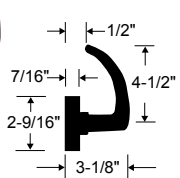

**MAXWELL 77**

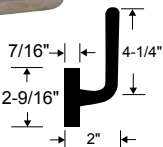

**AMERICAN 92**

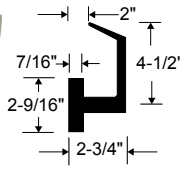

**OMNI 78**

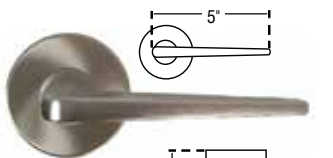
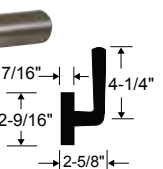

**5348**

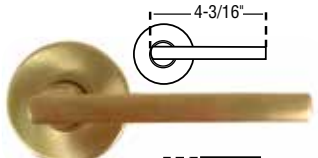
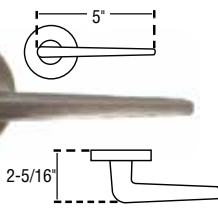

**5671**

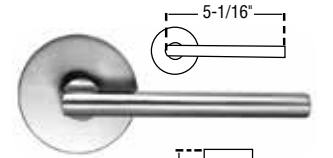
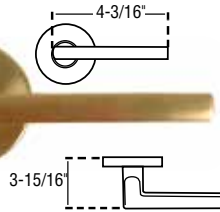

**SF031**

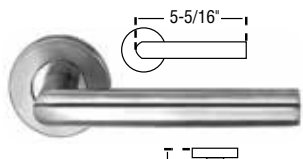
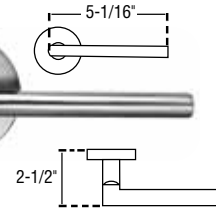

**SF037A**

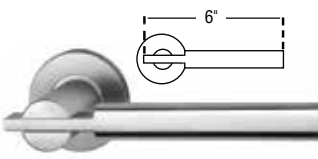
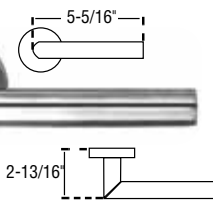

**SF095**

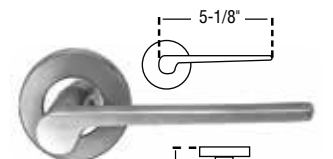
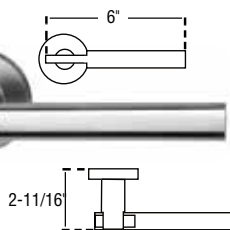

**SF117**

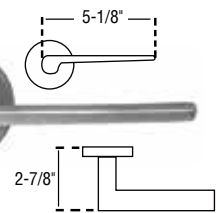

Style MARKS



[www.designalock.com](http://www.designalock.com) Create custom locks

Create and share a custom lock vision for any space or building with [www.designalock.com](http://www.designalock.com) interactive site for trying out various lock looks for locks inside and out. Ideal for Architects, Designers and Building Operating Management who want their access control and locking "look" to be as welcome as the security they provide.



# Sirenlock: Panic exit alarms

Sirenlock™ Models 250, 260, 700, and 710 are UL Listed panic alarm deadbolt devices which restrict unauthorized use of exit doors by sounding an alarm, while providing instant egress in emergencies



## Delayed egress exit alarm

### SIRENLOCK™ MODEL 715

- Offers stylish, cost-effective control of unauthorized use of exit doors
- 15 second delayed egress with instant 95db Dual Piezo alarm (meets UL specifications)
- Instant alarmed exit in case of actual emergency or fire (meets NFPA 1012 Life Safety Code)
- Easy-to-install, surface mount unit in a standard panic bar deadbolt/deadlatch design
- Monitoring output for simultaneous use of CCTV camera, secondary siren, remote monitoring console, etc.
- Smoke detector input can be used to power existing system or standalone smoke detector(s) (Includes armored door cord and cables for wiring)
- 9V battery back-up powers in event of power failure
- Requires standard RIM cylinder (not included)

### MODEL 11A (Not Shown)

(Dead bolt only; Not for ADA applications)

- Model 11A is an exit lock designed to control unauthorized use of emergency doors. It provides trouble free service and deters theft from within and outside. Unauthorized use sounds alarm which can only be reset or bypassed with key. Standard features include 1 inch throw deadbolt, warning alarm, outside cylinder capability, tamper switch and long life battery pack. Available for use with double doors or for use with existing panic bars. Optional AC power supply. Requires standard RIM cylinder (not included).

## Clapper plate & full door exit style alarms

### A – SIRENLOCK™ MODEL 250/260

### B – SIRENLOCK™ MODEL 700/710

- Deadbolt and deadlatch meet relatching requirements
- Blaring 95db dual tone siren
- Selectable 2-minute alarm or constant alarm
- 9V battery powered and audible low battery warning
- Meets or exceeds UL, CFM, ADA, NYC housing requirements
- 250/700 Models have changeable 2 minute alarm cutoff or manual reset.
- 260/710 Models have changeable 2 minute auto reset or manual reset
- Models 700 and 710 are available in 33" and 48" versions
- Model 700 is also available in red finish (700XRD) and 312 (Duronotic)
- Non-handed surface installations on single or double doors
- Requires standard RIM cylinder (not included)

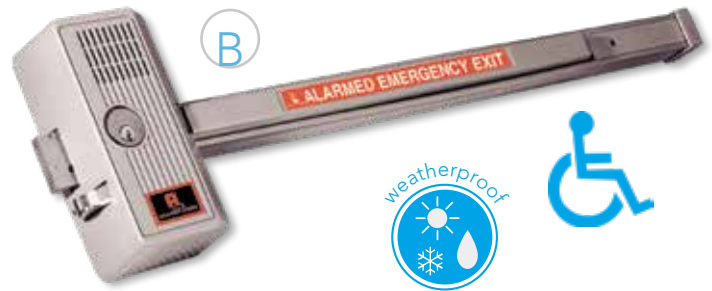

## Waterproof electronic alarmed panic locks

### 700/710x28WP and 250/260x28WP (models same as above)

- Suitable for outdoor use
- Weather-resistant for exposure to rain and precipitation, even in harsh conditions
- Wide operating temperature of -20°F to +140°F (-29° to +60°C)
- Powered with long-life sealed 9VDC alkaline battery pack (BP9)
- Loud 99db alarm

# Mags: Remote release mags, powermags & RTEs

## Innovative remote release mag-kit

### KIT RR-PM1200PAK

- Advanced 1200 lb. Electromagnetic Lock with Infrared Remote Release
- The power of a mag with the convenience of pocket-size remote controls for reception or staffers
- Complete turnkey system includes: Advanced 1200 lb. Mag, one remote control, and plug-in AC transformer
- Plug-in 12VAC transformer eliminates the requirement for pulling wires or the services of an electrician (optional use)
- Supports up to 100 individual remote controls (AL-REMOTE)
- Releases mag from either side of door
- AL-REMOTE Keyfob features single button operation with positive "click" response
- Automatically-enrolled by system in easy programming mode and is audibly and visually confirmed
- UL-listed; CE-listed



Easy buzz-in convenience from a mag lock. Ideal for reception areas!



## Electromagnetic locks

### PowerMag™ 12/24V

- Strong holding force of 600 and 1200 lb. models
- Perfect for both single and double doors and even sliding doors
- 5-year limited warranty
- Low voltage (12 or 24VDC); including field-selectable models
- Double door models with 1200 lb. locking per side (PM1200SLB1 and 40)

### PowerExit™ Request-to-Exit Push Buttons

- Come in five models, with or without illuminated buttons
- All models have solid aluminum anodized finish US28
- Sizes: 3' x 4 3/4" x 1/4" and 1 5/8" x 4 3/4" x 1/4"
- Back Depth: 1 1/4" and 1 7/8"
- Switch Rating: 250V AC 5A
- Momentary Action



## Electric door locks

### Models 103 & 104RA

- Models 103 & 104RA are compact electric locks simple to install on all types of doors. The door is locked or unlocked by remote switch, key switch, time programmer or other electrical contact which interrupts the power. Model 103 is our standard fail-safe unit which projects the bolt only while power is on. When the power is off the bolt retracts. Model 104RA (reverse action) unlike our standard unit is "fail-secure" and will project the bolt only when the power is "off." When the power is on the bolt retracts. 24AC/DC and 12VAC/DC models available



# Multifunction Door Alarms with Enhanced Features



**All-in-One: Exit Alarm • Door-Prop Alarm • Door Management Alarm • Door Annunciator • Timed-Bypass Alarm**

PG21MS Series surface-mount narrow stile door alarms  
**Ideal in schools, nursing homes, restaurants & theatres**

## PG21MS/PG21MB

- **Improve security at any door and stops security vulnerability from doors propped open, for innocent and even felonious reasons in schools, nursing homes, restaurants, stores and theaters**
- Two selectable arming modes –
  1. **Always armed mode** – when key is turned counter clockwise to the disarm position, the key cannot be removed. To remove key, turn back to arm mode, thus keeping unit armed always.
  2. **Standard arming mode** – when key is inserted turning counter clockwise will disarm and key can be removed. Turning key clockwise will arm and key can be removed.
- **Status Indicator** – The LED will indicate RED when armed
- **Long-life 9V battery** (supplied), low battery alert
- **Entry Delay Time Options:** Includes 15 seconds; 1 min. 15 sec. & 3 mins 15 sec.
- **For use on standard size and narrow stile doors**, sleek model design key-activated door alarm
- **Sweeping Siren over 95db alarm &/or strobe**
- **Unauthorized use of door causes alarm to sound** and activates LED indicator &/or optional strobe
- Options include **continuous alarm, minute shutdown with auto reset** and **exit/entry delay**
- **Uses standard mortise cylinder** (not included)
- **Self contained and dual-tamper supervised**
- **Continuous Power** with the addition of external power supply
- **Multiple Door Monitoring** permitted with external reed switches
- **Metallic silver or duronodic finish**
- **Easy installation**
- For exterior key control, optional RIM cylinder may be used
- **PG21MSS/PG21MBS Optional** strobe unit (shown left) – include a highly visible amber strobe that flashes when unit goes into alarm



Multiple door monitoring with built-in external reed switches, too.

## Model PG30KPD:

**Keypad-controlled narrow stile door alarm, similar to PG21, plus:**

- Digital codes for master, management and passage (used for auto-arming)
- 3 security levels for: a) high security b) unattended applications c) flexible control for delivery doors, etc.
- Audible low battery warning
- 3 Programmable 95db siren styles: sweep, pulsed, and steady
- Logo key is dual function test button



## PG30KPD Accessory:

- For optional use with the PG30, this low-profile, brushed aluminum finished accessory provides all functions of the PG30 from the outside of the door. (Available in metallic silver only.)

## Model PG10

- The Pilfergard Model PG10 is an exit door alarm designed to deter the use of the secured door by sounding a twin action alarm when opened by unauthorized personnel. The alarm can be bypassed from inside or outside by the use of a key. (Requires standard mortise cylinder not supplied.) This durable surface mount unit is easily installed and is tamper-supervised with two separate tamper switches. Its test button verifies battery. Optional AC power supply available.



## Model LL1

- All of the features of the PG10 unit with addition of a flashing strobe for easy alarm identification.
- Choice of system controllers





# Alarm Lock: Essential add-ons and extras

## Strikes for model 11A

### Model 210K

- Strike for single or double inswinging door(s) (not included with 11A)



### Model K24A

- Strike for single outswinging door (included with 11A)



## Rim cylinder

### Model CER

- Required for interior arming/disarming of models 11A, 80, 250, 260, 700, 710 & 715. Includes two keys (KA or KD)



## Mortise cylinder

### Model CEM

- Used with the Pilfergard models PG10 and PG21/E to arm and disarm the alarm circuit. Includes two keys (KA or KD)



## Cylinder finger pull

### Model 711

- An inexpensive door pull for use when outside key only access is required.



## Outside access door pull

### Model 707

- For access from building exteriors. Installed on the outside of the door and linked to the lock. After deadbolt is retracted by outside key, a slight pull will release the deadlatch and open the door. 8" x 1 1/2". (For use with all models except Model 11A).



## Battery eliminator

### Model PP100

- For use with all PG10, PG21/E, PG30, 250, 700, 80, 260, 710 and 715 models. The PP100 conserves the battery which automatically takes over as the power source to sound the alarm in the event of a power failure or intentional cut-off. A built-in circuit breaker with push-button reset eliminates troublesome fuse replacements. Includes a cam lock cylinder and 6' of armored cable adequate to provide a door loop at the hinged-side of the door. Can be used with all 6V and 9V models.



## Double door holder

### Model 44

- The Double Door Holder secures the inactive door to the frame while the active door is closed. Releasing the active door automatically allows both doors to swing freely. Reversible, right or left hand doors. Cast aluminum 8 1/2" long, 3" wide and 2 1/2" high.



## Armored door loop

### Model 271

- For use with electrified locks. An easy means for bringing electric current from the hinge side of a door frame to the door. 18" flexible armored cable. End brackets are deep drawn anodized aluminum to conceal wire connections.



## Single door strike

### Models 730 & 725

- Model 730 supplied with models 250, 700 and 80
- Model 730M supplied with models 260 and 710 and 80
- Model 725 supplied with model 715



## Double door strike

### Models 732 & 735

- Model 732 for use with models 250, 700 and 80.
- Model 732M for use with models 260 and 710.
- Model 735 for use with model 715. (Not Shown)



## Cable energy switch

### Model 261

- Transfers current to other side of the door.
- For use with models 250, 100 and 11A

## Severe Weather Keypad Guard

### Model HW2037

- Protects keypad from harsh outdoor weather conditions.



# Trilogy, Networkx & ArchiTech: Standalone &

Model & Feature	DL2700																
	DL2700	DL2700LD	CR/DB	DL2800	DL3000	PDL3000	DL3200	DL3500	PDL3500	DL4100	PDL4100	P/DL4500	DL5200	P/DL5300	P/DL6100	PDL6300	P/DL6500
Lock Type	Cylindrical	Cylindrical	Mortise, CR-Classroom, DB Beadbolt	Cylindrical	Cylindrical	Cylindrical Prox	Cylindrical	Mortise CR-Classroom, DB Beadbolt	Mortise Prox CR-Classroom, DB Beadbolt	Cylindrical	Cylindrical Prox	Mortise	Cylindrical	Cylindrical	Cylindrical Ethernet	Mortise Prox Ethernet, Double-sided	Mortise Prox Ethernet
Users	100	100	100	200	300	2000	2000	300	2000	2000	2000	2000	100	2000	5000	5000	5000
Code Length	3-6 digits	3-6 digits	3-6 digits	3-6 digits	3-6 digits	3-6 digits	3-6 digits	3-6 digits	3-6 digits	3-6 digits	3-6 digits	3-6 digits	3-6 digits	3-6 digits	3-6 digits	3-6 digits	3-6 digits
Programming	Keypad only	Keypad only	Keypad only	Keypad /PC	Keypad /PC	Keypad /PC	Keypad /PC	Keypad /PC	Keypad /PC	Keypad /PC	Keypad /PC	Keypad /PC	Keypad only	Keypad /PC	Keypad /PC	Keypad /PC	Keypad /PC
Vandal-Proof Keypad	All metal, 12 button	All metal, 12 button	All metal, 12 button	All metal, 12 button	All metal, 12 button	All metal, 12 button	All metal, 12 button	All metal, 12 button	All metal, 12 button	All metal, 12 button	All metal, 12 button	All metal, 12 button	Dual sides, All metal, 12 button	Dual sides, All metal, 12 button	All metal, 12 button	All metal, 12 button	All metal, 12 button
Trim w/Rugged Clutch	Straight or curved lever	Straight or curved lever	Straight or curved lever	Straight or curved lever	Straight or curved lever	Straight or curved lever	Straight or curved lever	Straight or curved lever	Straight or curved lever	Straight or curved lever	Straight or curved lever	Straight or curved lever	Straight or curved lever	Straight or curved lever	Straight or curved lever	Straight or curved lever	Straight or curved lever
Audit Trail Events				1000	1600	40000	40000	40000	40000	40000	40000	40000		40000	35000	40000	35,000
Scheduled Events				150	150	500	500	500	500	500	500	500		500	500	500	500
Reader/Credential-Support						Prox HID			Prox HID		Prox HID	PDL4500 for HID Prox		PDL5300 for HID Prox	PDL6100 for HID Prox	HID Prox	PDL6500 for HID Prox
iLock® App Mobile Solution																	
Lockdown or Privacy		Lockdown w/ Keyfob incldd								Privacy/ Lock-out	Privacy/ Lock-out	Privacy/ Lock-out			Global lockdown	Global lockdown	Global lockdown
Function		Lockdown Indicator light bar (inner door)						CR Classroom or DB Deadbolt	CR Classroom or DB Deadbolt			DB Deadbolt					
Door Position Switch															PDL6200; PDL8200 with iClass support		PDL6600; PDL8600 with iClass support
Request to Exit															PDL6200; PDL8200 with iClass support		PDL6600; PDL8600 with iClass support
Weather-Proof 31 To 151° F	WP version	Standard	Standard	Standard	WP version	Standard	Standard	Standard	Standard	Standard	Standard	Standard	Standard	Standard	Standard	Standard	Standard
Handing	Nonhanded	Nonhanded	Handed; Field Reversible	Nonhanded	Nonhanded	Nonhanded	Nonhanded	Handed; Field Reversible	Handed; Field Reversible	Nonhanded	Nonhanded	Handed;	Nonhanded	Nonhanded	Nonhanded	Handed; Field Reversible	Handed; Field Reversible
Door Thickness	1-5/8 to 1-7/8" (others on request.)	1-5/8 to 1-7/8" (others on request.)	1-5/8 to 1-7/8" (others on request.)	1-5/8 to 1-7/8" (others on request.)	1-5/8 to 1-7/8" (others on request.)	1-5/8 to 1-7/8" (others on request.)	1-5/8 to 1-7/8" (others on request.)	1-5/8 to 1-7/8" (others on request.)	1-5/8 to 1-7/8" (others on request.)	1-5/8 to 1-7/8" (others on request.)	1-5/8 to 1-7/8" (others on request.)	1-5/8 to 1-7/8" (others on request.)	1-5/8 to 1-7/8" (others on request.)	1-5/8 to 1-7/8" (others on request.)	1-5/8 to 1-7/8" (others on request.)	1-5/8 to 1-7/8" (others on request.)	1-5/8 to 1-7/8" (others on request.)
Backset	2-3/4" (included); 2-3/8" option.	2-3/4" (included); 2-3/8" option.	2-3/4" (included)	2-3/4" (included); 2-3/8" option.	2-3/4" (included); 2-3/8" option.	2-3/4" (included); 2-3/8" option.	2-3/4" (included); 2-3/8" option.	2-3/4" (included); 2-3/8" option.	2-3/4" (included)	2-3/4" (included); 2-3/8" option.	2-3/4" (included); 2-3/8" option.	2-3/4" (included)	2-3/4" (included); 2-3/8" option.	2-3/4" (included); 2-3/8" option.	2-3/4" (included); 2-3/8" option.	2-3/4" (included)	2-3/4" (included)
Cylinder	Large key-in-knob, incld or- IC Prep for Best/Falcon/ Arrow (w/o cyld.)	Large key-in-knob, incld or- IC Prep for Best/Falcon/ Arrow (w/o cyld.)	Generic mortise cylinder, supplied.	Large key-in-knob, incld or- IC Prep for Best/Falcon/ Arrow (w/o cyld.)	Large key-in-knob, incld or- IC Prep for Best/Falcon/ Arrow (w/o cyld.)	Large key-in-knob, incld or- IC Prep for Best/Falcon/ Arrow (w/o cyld.)	Large key-in-knob, incld or- IC Prep for Best/Falcon/ Arrow (w/o cyld.)	Generic mortise cylinder, supplied.	Generic mortise cylinder, supplied.	Large key-in-knob, incld or- IC Prep for Best/Falcon/ Arrow (w/o cyld.)	Large key-in-knob, incld or- IC Prep for Best/Falcon/ Arrow (w/o cyld.)	Generic mortise cylinder, supplied.	Large key-in-knob, incld or- IC Prep for Best/Falcon/ Arrow (w/o cyld.)	Large key-in-knob, incld or- IC Prep for Best/Falcon/ Arrow (w/o cyld.)	Large key-in-knob, incld or- IC Prep for Best/Falcon/ Arrow (w/o cyld.)	Large key-in-knob, incld or- IC Prep for Best/Falcon/ Arrow (w/o cyld.)	Generic mortise cylinder, supplied.
Special Order Cylinders	Yale, Medeco, Sargent, Corbin/ Russwin, Schlage	Yale, Medeco, Sargent, Corbin/ Russwin, Schlage		Yale, Medeco, Sargent, Corbin/ Russwin, Schlage	Yale, Medeco, Sargent, Corbin/ Russwin, Schlage	Yale, Medeco, Sargent, Corbin/ Russwin, Schlage	Yale, Medeco, Sargent, Corbin/ Russwin, Schlage			Yale, Medeco, Sargent, Corbin/ Russwin, Schlage	Yale, Medeco, Sargent, Corbin/ Russwin, Schlage		Yale, Medeco, Sargent, Corbin/ Russwin, Schlage	Yale, Medeco, Sargent, Corbin/ Russwin, Schlage	Yale, Medeco, Sargent, Corbin/ Russwin, Schlage		
Relay Options	yes	yes	yes		yes	yes	yes	yes	yes	yes	yes	yes	no	no	yes	no	yes
Battery/Cycles typical	5AA; 200000 or up to 5 years	5AA; 100000 or up to 3 - 4 years	5AA; 60000	5AA; 100000	5AA; 100000	5AA; 60000	5AA; 100000	5AA; 100000	5AA; 60000	5AA; 100000	5AA; 60000	5AA; 60000	5AA; 80,000	5AA; 100000	4 C cells 5 years 500,000	4 AA 3-4 years 600,000	4 C cells 5 years 500,000
Ratings	BHMA Grade 1 Lockset; 3hr. Fire Rated UL	BHMA Grade 1 Lockset; 3hr. Fire Rated UL	3hr. Fire Rated UL	BHMA Grade 1 Lockset; 3hr. Fire Rated UL	BHMA Grade 1 Lockset; 3hr. Fire Rated UL	BHMA Grade 1 Lockset; 3hr. Fire Rated UL	BHMA Grade 1 Lockset; 3hr. Fire Rated UL	3 Hr Fire Rated UL	3 Hr Fire Rated UL	BHMA Grade 1 Lockset; 3hr. Fire Rated UL	BHMA Grade 1 Lockset; 3hr. Fire Rated UL	3 Hr Fire Rated UL	BHMA Grade 1 Lockset; 3hr. Fire Rated UL	BHMA Grade 1 Lockset; 3hr. Fire Rated UL	BHMA Grade 1 Lockset; 3hr. Fire Rated UL	3 Hr Fire Rated UL	3 Hr Fire Rated UL
Architectural Finishes	US26D, US3, 10B	US26D, US3, 10B	US26D, US3, 10B	US26D, US3, 10B	US26D, US3, 10B	US26D, US3, 10B	US26D, US3, 10B	US26D, US3, 10B	US26D, US3, 10B	US26D, US3, 10B	US26D, US3, 10B	US26D, US3, 10B	US26D, US3, 10B	US26D, US3, 10B	US26D, 10B	US26D, 10B	US26D, 10B

**LEGEND:**

- Privacy -
- Class Lockdown -
- Narrow Stile -
- Networkx Wireless -
- Double-Sided -
- Keypads -
- ArchiTech -

(Note: Also see ordering information charts pg. 11 and 20)

# Wireless Access Control Locks & Special Models

PDL8200	DL1200	P/DL1300	ETDL2700	ETDL	ETPDL	ETDLN, ETPDN	DL1200ET	P/DL1300ET	P/DL1300NW	DK3000	PDK3000	NETDK/ NETPDK	N90S/ST	N90L	N95S/T	N95I/J
Cylindrical Prox Ethernet	Narrow Stile	Narrow Stile	For use w/exit device	For use w/exit device	For use w/exit device ,Prox	For use w/panic device Ethernet	Narrow Stile For use w/panic device	Narrow Stile For use w/panic device	Narrow Stile PDL1300NWET for use with exit device	Standalone Keypad	Standalone Keypad, Prox	Keypad Ethernet	Cylindrical Surface Mount, Ethernet	Cylindrical Surface Mount, Ethernet	Mortise Surface Mount, Ethernet	Mortise Insert Electronics, Ethernet
5000	100	2000	100	2000	2000	2000	100	2000	5000	2000	2000	5000	5000	5000	5000	5000
3-6 digits	3-6 digits	3-6 digits	3-6 digits	3-6 digits	3-6 digits	3-6 digits	3-5 digits	3-6 digits	3-6 digits	3-6 digits	3-6 digits	3-6 digits				
Keypad /PC	Keypad	Keypad /PC	Keypad only	Keypad /PC	Keypad /PC	Keypad /PC	Keypad	Keypad /PC	Keypad /PC	Keypad /PC	Keypad /PC	Keypad /PC	Card Reader/PC	Card Reader/PC	Card Reader/PC	Card Reader/PC
All metal, 12 button	All metal, 12 button	All metal, 12 button	All metal, 12 button	All metal, 12 button	All metal, 12 button	All metal, 12 button	All metal, 12 button	All metal, 12 button	All metal, 12 button	All metal, 12 button	All metal, 12 button	All metal, 12 button				
Straight or curved lever	Straight or curved lever, thumbturn or knob	Straight or curved lever, thumbturn or knob	Straight or curved lever	Straight or curved lever	Straight or curved lever	Straight or curved lever	Straight or curved lever, thumbturn or knob	Straight or curved lever, thumbturn or knob	Straight or curved lever,			Straight or curved lever	Std Lever Rose Hardware Design; Choice of 4 lever designs	Choice of 3 levers	Std Lever Rose Hardware Design, Custom choice of 300 Grade 1 Trim lever/knob designs	Std Lever Rose Hardware Design, Custom choice of 300 Grade 1 Trim lever/knob designs
35,000		40000		40000	40000	40000		40000	40000	40000	40000	35000	40000	36000	40000	40000
500		500		500	500	500		500	500	500	500	500	500	500	500	500
iClass HID Prox 13.56MHz		PDL1300 for Prox HID			Prox HID	ETPDLN for Prox HID; ETPDNI for iClass support		PDL1300ET for Prox	PDL1300NW for HID Prox		Prox HID	NETPDK for HID Prox	Choice of Oval or Square Multitechnology Reader, HID, iClass; Also available Mag Swipe Reader	Choice of Oval or Square Multitechnology Reader in black or silver, HID, iClass; Also available Mag Swipe Reader	Choice of Oval or Square Multitechnology Reader, HID, iClass; Also available Mag Swipe Reader	Choice of Oval or Square Multitechnology Reader, HID, iClass
													T Model has Bluetooth LE App - No keys, no ID + Audit trail		T Model has Bluetooth LE App - No keys, no ID + Audit trail	J Model has Bluetooth LE App - No keys, no ID + Audit trail
Global lockdown						Global Lockdown			Global Lockdown			Global lockdown	Global lockdown	Global lockdown	Global lockdown	Global lockdown
													FD	Flashing lockdown strobe indicator (inner door)	CR Classroom or DB Deadbolt; FD	CR Classroom or DB Deadbolt; FD
						ETPDN-RX; ETPDNI-RX with iClass support										
Standard	Standard	Standard	Standard	Standard	Standard	Standard	Standard	Standard	Standard	Standard	Standard	Standard				
Nonhanded	Nonhanded	Nonhanded	Nonhanded	Nonhanded.	Nonhanded.	Nonhanded.	Nonhanded	Nonhanded	Nonhanded			Nonhanded	Nonhanded	Nonhanded	Handed; Field Reversible	Handed; Field Reversible
1-5/8 to 1-7/8" others upon request	1-3/4"	1-3/4"	1-5/8 to 1-7/8" \	1-5/8 to 1-7/8" (others on request.)	1-5/8 to 1-7/8" (others on request.)	1-5/8 to 1-7/8" (others on request.)	1-3/4"	1-3/4"	1-3/4"			1-5/8 to 1-7/8" others upon request	1-5/8" to 1-7/8" others upon request	1-5/8" to 1-7/8" others upon request	1-5/8" to 1-7/8" others upon request	1-5/8" to 1-7/8" others upon request
2-3/4" (included) 2-3/8" opt.	31/32", 1-1/8", 1-1/2"	31/32", 1-1/8", 1-1/2"					31/32", 1-1/8", 1-1/2"	31/32", 1-1/8", 1-1/2"	31/32", 1-1/8", 1-1/2"			2-3/4" (included) 2-3/8" opt.	2-3/4" (included)	2-3/4" (included)	2-3/4" (included)	2-3/4" (included)
Large key-in-knob, incld -or IC Prep for Best/Falcon/Arrow (w/o cyld.)	Generic 1-1/4" mortise cylinder, supplied. 1-1/8", 1-1/4", 1-3/8" supported	Generic 1-1/4" mortise cylinder, supplied. 1-1/8", 1-1/4", 1-3/8" supported	Generic Rim Cylinder, supplied. Other mfrs. Cylinder Adapters must be ordered separately.	Generic Rim Cylinder, supplied. Other mfrs. Cylinder Adapters must be ordered separately.	Generic Rim Cylinder, supplied. Other mfrs. Cylinder Adapters must be ordered separately.	Generic Rim Cylinder, supplied. Other mfrs. Cylinder Adapters must be ordered separately.	Generic 1-1/4" mortise cylinder, supplied. 1-1/8", 1-1/4", 1-3/8" supported	Generic 1-1/4" mortise cylinder, supplied. 1-1/8", 1-1/4", 1-3/8" supported	1-1/4" mortise cylinder, supplied;. for Best, Falcon, Arrow prep cam and housing available			Large key-in-knob, incld -or IC Prep for Best/Falcon/Arrow (w/o cyld.)	Large key-in-knob, incld -or IC Prep for Best/Falcon/Arrow		Generic mortise cylinder supplied	Generic mortise cylinder supplied
Yale, Medeco, Sargent, Corbin/Russwin, Schlage	Yale, Medeco, Corbin/Russwin, Schlage	Yale, Medeco, Corbin/Russwin, Schlage					Yale, Medeco, Corbin/Russwin, Schlage	Yale, Medeco, Corbin/Russwin, Schlage				Yale, Medeco, Sargent, Corbin/Russwin, Schlage	Yale, Medeco, Sargent, Corbin/Russwin, Schlage		Best/Falcon/Arrow, Schlage (Note: must order appropriate IC Housing)	Best/Falcon/Arrow, Schlage (Note: must order appropriate IC Housing)
yes			yes	yes	yes	yes			no	yes	yes	yes				
4 C cells 5 years 500,000	2-3V Lithium, 100,000	2-3V Lithium, 80,000	SAA; 60000	5AA; 60000	5AA; 60000	4 C cells, 5 years/500,000	2-3V Lithium, 100,000	2-3V Lithium, 80,000	4 AA; 100,000 3-4 years			4 C cells 5 years 500,000	4 AA, 3 years / 100,000 (w/ Power Saver Circuit)	4 AA, 3 years / 100,000 (w/ Power Saver Circuit)	4 AA, 3 years / 100,000 (w/ Power Saver Circuit)	4 AA, 3 years / 100,000 (w/ Power Saver Circuit)
BHMA Grade 1 Lockset; 3hr. Fire Rated UL									3 Hr Fire Rated	UL	UL	Pending	BHMA Grade 1 Lockset; 3hr. Fire Rated UL	BHMA Grade 1 Lockset; 3hr. Fire Rated UL	BHMA Grade 1 Lockset; 3hr. Fire Rated UL	BHMA Grade 1 Lockset; 3hr. Fire Rated UL
US26D, 10B	US10B, US26D, MS, MB	US10B, US26D, MS, MB	US26D, US3, 10B	US26D, US3, 10B	US26D, US3, 10B	US26D, 10B	US10B, US26D, MS, MB	US10B, US26D, MS, MB	US26D, 10B	US10B, US26D, MS, MB	US10B, US26D, MS, MB	US26D, 10B	Customizable; Std US26D, 10B	Customizable; Std US26D, 10B	Customizable; Std US26D, 10B	Customizable; Std US26D, 10B



# K-12 and Campus Security LocDown™ Solutions:



Everyone involved in schools, from parents, students and teachers to administrators and facility managers, are actively looking for expert solutions and actionable steps to secure their K-12 or college/university. And, you can be that expert provider. Better access control is one of the best steps you can offer and they can truly use today – right now. Here are some of our tiered solutions for any application & budget:

- Rugged, easy to use and install electronic Trilogy locks add access convenience & quickly retrofit any lockset on virtually any door, inside or out.
- Easily add keyfob or panic button option to most new & existing Trilogys (3000 Series & above) and program to control "Lock Down" or "Remote Release" with one button.
- New DL2700LD model locks down with keyfobs from up to 75' away, one supplied, and includes large indicator light on inner door to confirm lock-down is activated. (Weather Resistant for outside applications, standard.)

- Supports up to 5000 PIN-code or ID card users
- Controls electric strike, Mag Lock or exit device with electric latch retraction (ex. narrow stile glass doors).
- Operates 1 or 2 Network Keypads, PIN-code or PIN & Prox ID or supports standard Wiegand output Prox Readers.
- Inputs for Door-Position Switch and/or Remote Release
- Includes, rechargeable battery backup, 1.5amp power supply, & plug in AC transformer.
- Top features: Global lockdown and passage from keypad or PC; schedules; 35K event log, request-to-exit, door ajar/kick-in, etc.
- Kits with Network keypads or NetPanel only



## Electronic Standalone Locking Solution with Local Lock Down

### Alarm Lock Trilogy P/DL 4100/4500 Series

- Simple push button locks door from inside, or use keyfob
- Activates small light indicators on front & back sides of door
- Includes bilingual signage on use and lock down
- Override option by authorized administrators
- No keys, key hassles; access controlled with ID card or digital code (overridden in lockdown emergency)
- 1 Hours installation. Can be field converted into Wireless Network Locks later with kit (as below)
- Grade 1 Durable, Vandal-Resistant All Metal Locks, for inside & outdoors



## Wireless Network Locking Solutions with Global Lock Down

### Trilogy Networkx 6000, 8000 Series

Global Lockdown activated from the server or any individual access lock, in under 10 seconds

- Deploy wireless networked access locks in under an hour
- ID Card and/or Digital Code Access (PIN)
- Real-time global lockdown or unlock in under 10 seconds
- Scalable by door, area, building or across a campus of buildings, new & legacy
- Manage on-premises or remotely via web client or smart device- Control access, privileges, locks and doors, by time schedule, exception, etc.
- Grade 1 Durable, Unparalleled battery life, 5 years+



## Designer Access Control Networked Locks with Strobe Indicator

### ArchiTech N90L

Wireless Networked Access Locks with LocDown® Keyfob-Activation & Emergency Strobe

- Standalone locks or locks networked campus-wide via 802.11 or Ethernet - Enterprise security integration, too
- Keyfob-Activated Lockdown & bright flashing strobe indicator on inside door gives security control & peace of mind to occupants
- Lock down One Door or a Global Lock Group in seconds from any keyfob on the system (each with programmable access, lock- and unlock-privileges)
- Customizable, sleek minimalist look, choice of levers, multi-technology access ID readers, in various colors, shapes & architectural finishes
- Keyless access for up to 5000 users, w/ 500 Scheduled Events & 36,000 Event Log.



## Electronic Standalone Locking Solutions with Keyfob & /or Panic Button Lock Down

### Trilogy Locks with Keyfob &/or Panic Option

Lock down classrooms, offices, common areas, labs from safely inside, with the press of a button



## Small Wireless PIN/ID Card Keypad Access System with Global Lock Down

### Networkx NetPanel & Wireless Keypad Solution

Affordable Access System with Global Lock Down

### PG21 Series

Easily stop any door from being propped open, for innocent and/or felonious reasons, i.e., for later reentry, etc.

pg 24



**SAVI™**, the Security Access-Control Vulnerability Index™ is what we created for security professionals to use as an objective, brand-agnostic audit tool to evaluate any school's access control vulnerability. You simply survey what kinds of security they have in place, and SAVI automatically calculates a score for them now. Then you use that to create a plan of actionable next-steps you can suggest and deploy, to improve their security and SAVI score, ranging from adding ballistic glass or better gates, to classroom intruder- or standalone digital access -locks with

lockdown function or keyfobs. Or, from adding networked wireless locks with near-instantaneous global lockdown, to implementing an access control systems for a few doors to many, in real time.

**Become a certified SAVI professional.** We'll show you how. You'll learn how to market, approach and make a positive impact in the educational market that so desperately needs objective answers and your expertise. Call us 1-800-ALA-LOCK for training today or email SAVI@alarmlock.com.

FOR ALL OUR SCHOOL SOLUTIONS & REFERENCES go to [www.savischool.com](http://www.savischool.com)

# About Us

**Alarm Lock Systems, LLC** is a respected leader in the design and manufacture of commercial door technology solutions for over four decades, specializing in access and egress solutions for education, healthcare, government, airports, corporations and mixed-use environments. Its popular Trilogy® line enables professionals securing buildings of all kinds to more cost-effectively and quickly add dependable coded or ID-carded wireless access control a door at a time, with a dependable field-proven access solution and a consistent model for every door type in a facility (cylindrical, mortise, narrow stile/glass, privacy or double-sided).

Number One in their class for many years running, Trilogy® electronic access control locks, include original standalone digital and Prox models, with built-in HID® or iClass™ Prox reader, new classroom lock-down keyfob-controlled locks, as well as wireless networking Trilogy Networkx™ access locks, featuring global lockdown in seconds, from a lock, server or keyfob and the elimination of door-to-door programming and audit trail event queries by communicating wirelessly via ethernet or 802.11, and Networkx Gen.2 Gateways & Expanders for greater range. Alarm Lock's iLock® Smartphone App puts key-free, badge-free convenience on any smartphone/device using secure BlueTooth LE™ communications with any Apple® or Android smart phone or tablet, too.. Blending with even the most demanding decor, ArchiTech™ Networkx Series are customizable with hundreds of trims, finishes, and reader designs for the ideal architecturally-elegant access solution. All Trilogys feature the same rugged dependability, tool-free keypad programming and unsurpassed long battery life, with cylindrical models boasting Grade 1 BHMA certification. Alarm Lock Networkx™ Prox ID and PIN Code Keypads and NetPanel 2-Door Access Controller provide a wireless keypad solution for use with magnetic locks, strikes and electrified exit devices. All programmable Alarm Lock models share the same database, programming, scheduling and functionality and use Alarm Lock's Free Windows-based software. Many Networkx & ArchiTech models can also be integrated within an enterprise security system platform, in real-time, as a single-door controllers with Continental Access® CA4K, Lenel® OnGuard® Open Access Integration, and as a Software House® Connected Program Partner.



## Grow with Alarm Lock's Profit Center Program

Today's electronic pushbutton locks offer considerable security, key-free consumer convenience and ease of retrofitting standard door locks. Add to that more stringent security needs, virtually everywhere, and the result has been that installations of standalone access control locks, with and without door-usage logging, are increasingly in demand, with no end or slow down in sight. For those eager to enter this lucrative, booming market and expand and complement their traditional offerings, Alarm Lock, the leader in electronic pushbutton access locks, has specially designed a program for retail locksmiths to tap this potential and grow their business.

The Alarm Lock Profit Center Program offers retail locksmiths and their technicians FREE simple, step-by-step, field-proven methods. Trained professionals teach and guide locksmith/dealers exactly how to install, sell and compete effectively in this marketplace. Your technicians will become expert on the product, its application and its marketing, through our comprehensive system of training seminars, joint sales calls and presentations to your customers! In simplest terms, we've designed a program that will help you secure and grow your bottom line with us. To enroll in our Free "Profit Center Program" just contact your Alarm Lock Sales Representative at 1-800-ALA-LOCK.

## Alarm Lock Training Classes are available locally in the field nationwide and online

- Get training for you and your staff on using the latest new technology, installation & programming techniques, growth in new markets and even earn factory-certification on Alarm Lock products from Trilogy Standalone Locks, to Wireless Networked Networkx Locks, Gateways and our NetPanel. All Alarm Lock Classes are hands-on classes taught with real-world applications and locking expertise.
- **Online Webinar classes** can be taken right from your computer: No gas or travel required, and optionally, continuing ed. credits, without ever leaving your office. They are presented live, and each is followed by a Question & Answer Session.
- **Previously-Recorded Webinars** are available when you are, ideal as a refresher too, 24/7.
- **Class schedule & to register** visit [www.alarmlock.com/seminars](http://www.alarmlock.com/seminars)
- **Training Videos on YouTube** visit [www.youtube.com/c/alarmlock](http://www.youtube.com/c/alarmlock)



Alarm Lock Systems is a leader in access and egress solutions for education, healthcare, multi-use commercial, retail, transportation & industry. Field-proven standalone Trilogy® electronic keyless access locks, provide access control with PIN-code or built-in HID® Prox, multi-technology or swipe reader for ID badges. Wireless Trilogy Network™ access locks, are easily networked using Gateways and Expanders, eliminating door-to-door operations and featuring global lockdown or unlock in seconds, activated from any lock or the computer network's server. ArchiTech™ Network Series take it a step farther with hundreds of customizable trims, finishes, and readers for the ideal architecturally-elegant access solution and offer iLock® App mobile solution. Both lines feature keyfob and remote button support; plus free Windows-based or enterprise software options; and models for every application & budget.



Standalone • Wireless • Enterprise Solutions



345 Bayview Avenue Amityville, NY 11701 USA • 1-800-ALA-LOCK • 631-789-4871 • Fax: 631-789-3383

**Alarm Lock Systems, LLC is a Division of NAPCO Security Technologies, Inc.**

*Trilogy, Sirenlock, Networkx, ArchiTech, SAVI / School Access-Control Vulnerability Index, iLock and CA4K are trademarks of Alarm Lock/Napco. All others are trademarks of their respective companies.*  
 © Alarm Lock, 2019. Specifications may be subject to change without prior notice. Pats & Pats. Pending. ALA112U