

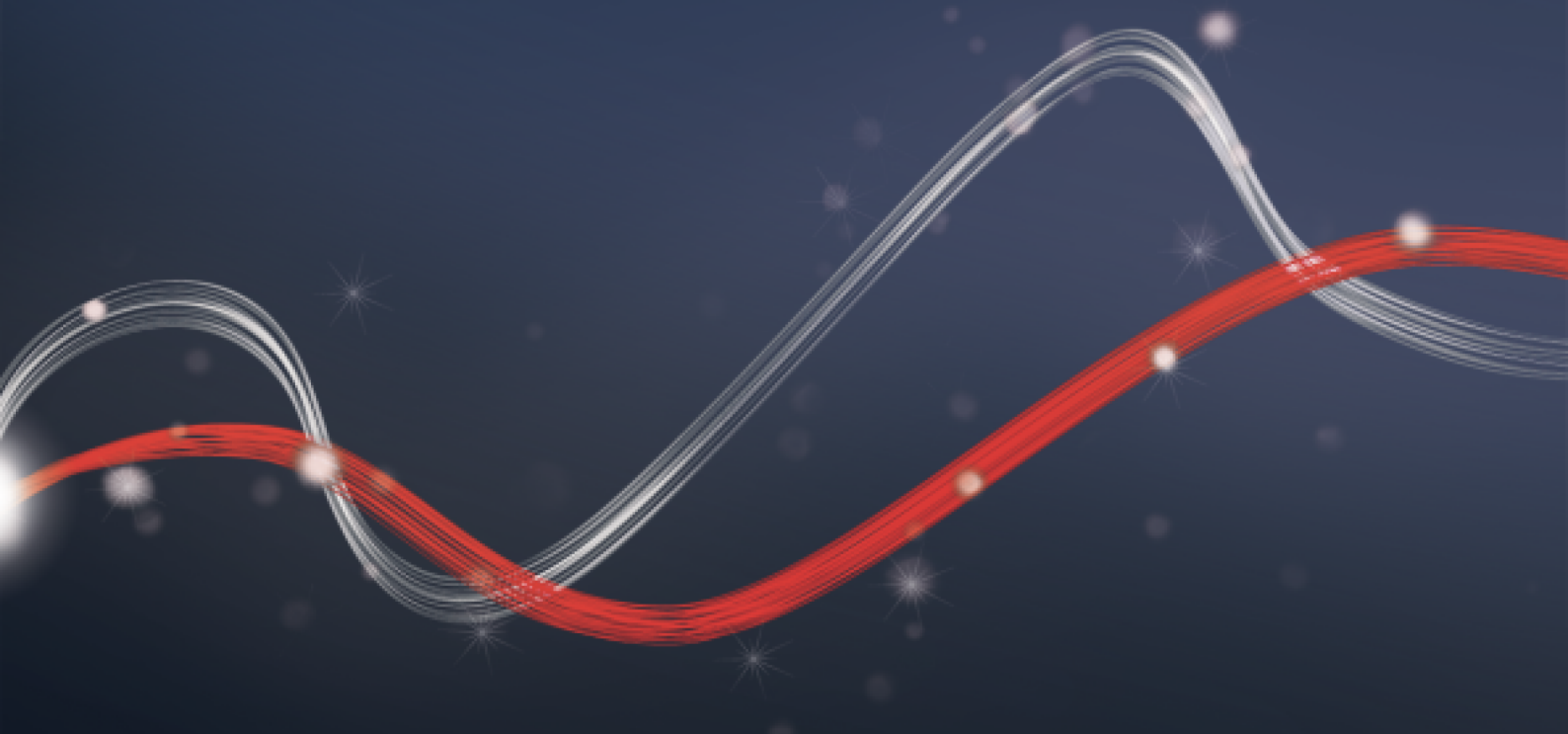

Be ahead



PHOBOS BT A





PHOBOS BT A



Electromechanical automation systems for swing gates



rolling code



er ready



ee link



d-track



24 V



U-Link

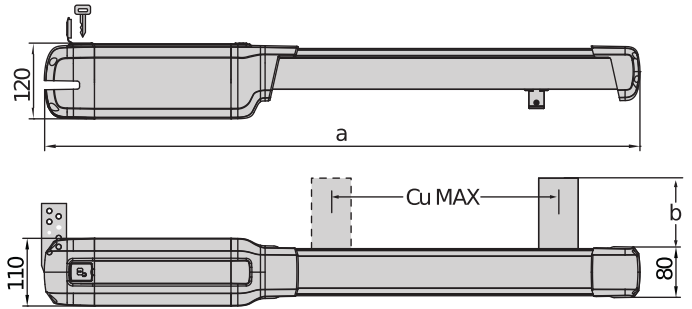

	a	b	Cu MAX
Phobos BT A25	850	72,5	290
Phobos BT A40	960	108	400
Phobos AC A25	850	72,5	350
Phobos AC A40	960	108	460

Complete range of electromechanical pistons for residential use, suitable for swing gate leaves up to 4 metres wide and weighing up to 500 kg. Obstacle detection: the management and control system of the D-Track pair ensures maximum safety for people and property, as well as facilitating certification of the system

Relevant features



Magnetic limit switch: the magnetic limit switch system ensures maximum precision of movement and quick and easy adjustment



Magnetic pin: an exclusive feature of Bft operators enabling quicker installation steps, making them easier and always ensuring correct rear locking of the operator

ADVANTAGES

Obstacle detection: the management and control system of the D-Track pair ensures maximum safety for people and property, as well as facilitating certification of the system





Electromechanical automation systems for swing gates

PHOBOS BT A

Code	Name		Description
P935096 00002	PHOBOS BT A25		Irreversible electromechanical operator 24 V for swing gates weighing up to 400 kg and 2.5 m long. Magnetic limit switch
P935095 00002	PHOBOS BT A40		Irreversible electromechanical operator 24 V for swing gates weighing up to 500 kg and 4 m long. Magnetic limit switch
R935306 00005	PHOBOS BT KIT A25 FRA		Complete kit 24 V for swing gates up to 400 kg in weight and 2.5 m in length. Magnetic limit switch
R935309 00005	PHOBOS BT KIT A40 FRA		Complete kit 24 V for swing gates up to 500 kg in weight and 4 m in length. Magnetic limit switch

THALIA: Control panel with display for one or two 24V electromechanical operators for swing gates



D113745 00002 - THALIA - Recommended



- Application: control panel with display for one or two 24V electromechanical operators for swing gates
- Card power supply: 230 V single-phase
- Operators power supply: 24Vdc 180W max each operator
- Main features: new standard colour removable terminal blocks, simplified scenario-based programming with display and integrated dual-channel receiver, D-Track anti-crushing system, slowdown during opening and closing and electronic self-learning.
- Main functions: automatic re-closing, fast closing, partial opening, deadman feature
- Compatibility: LIBRA C MA, LIBRA, LIBRA R, LIBRA MA R













	PHOBOS BT A25	PHOBOS BT A40
Control unit	THALIA, ZARA	THALIA, ZARA
Board power supply	230 V	230 V
Motor voltage	24 V	24 V
Power consumption	40 W	40 W
Max. width of door/gate wing	2,50 m	4 m
Max. weight of door/gate wing	400 kg	500 kg
Useful rod stroke	290 mm	400 mm
Maximum angle	116 °	124 °
Cycle time	15 s	20 s
Type of limit switch	Magnetic	Magnetic
Slowdown	Yes	Yes
Locking	Mechanical	Mechanical
Release	Personal key	Personal key
Impact reaction	D-Track	D-Track
Frequency of use	intensive	intensive
Protection rating	IPX4	IPX4
Environmental conditions	-20 ÷ 55 °C	-20 ÷ 55 °C





Electromechanical automation systems for swing gates

RECOMMENDED ACCESSORIES

	 D113747 00002 - THALIA P		N733427 - ARB PHOBOS N
<p>Control panel for one or two 24V electromechanical and hydraulic operators for swing gates with electric lock management, for highly complex systems</p>		<p>Front and rear adjustable bracket for PHOBOS operator</p>	
	N733428 - ARB PHOBOS N L		P125020 - BBT BAT
<p>Front and rear adjustable bracket for PHOBOS operator</p>		<p>Set of backup batteries for THALIA and THALIA P</p>	
	 D114093 00003 - RADIUS LED BT A R1		 D114094 00003 - RADIUS LED BT A R0
<p>Flashing light with incorporated antenna for motors with power supply 24 V.</p>		<p>Flashing light without incorporated antenna for motors with power supply 24 V.</p>	
	 D114168 00003 - RADIUS LED BT A R1 W		 P111782 - COMPACTA A20-180
<p>Flashing light with built-in antenna for motors with a 24 V power supply. White flashing light.</p>		<p>Pair of photocells adjustable 180 ° horizontally. Range 20m. Power supply 12 – 33Vac / 15 – 35Vdc</p>	





Electromechanical automation systems for swing gates

What is U-Link?

The technology that gives you more power

U-Link, Universal Link, is an exclusive BFT platform that can be used to create high-tech ecosystems. In Home Access Automation, it can be used to communicate with all home access automation devices of any brand. This saves you time and allows you to control everything easily and without any worries.

It is intuitive

Easy to install and to use

It is scalable

You can add as many devices as you want

It is flexible

It allows you to create groups of interconnected products

It is practical

Works with or without an internet connection

It is functional

Its settings can be controlled remotely using dedicated applications



Electromechanical automation systems for swing gates

Everything on one screen: find out more about this amazing technology

A world-exclusive platform that **can be used to create high-tech ecosystems** offering a vast range of solutions for many different sectors.

This proprietary platform which is a key feature of BFT products, thanks to the B-EBA cards and the Clonix U-Link receiver, is suitable for any protocol or product for access automation (including BFT products non-BFT ones and older versions) and it can be used in a variety of different sectors. This means any device becomes a smart device which can be interconnected with other systems, using a language that is becoming universal.



U-Control HOME

U-Control HOME is the application that allows you to open the gate to your home and to remotely control BFT automations using your own smartphone. The iOS version can be used to automatically open the automation when you are close to it.



U-Base 2

A software package for installation, performing maintenance and identifying any faults in the U-Link compatible operators, easily and conveniently.



U-SDK

U-SDK is the application which allows BFT automations to be made compatible and easily integrated with a BMS network.



Clonix U-Link

Connect non-native U-Link and non-BFT products to U-Link systems.

Is it possible to connect non-native U-Link BFT operators or other brands of products to U-Link? Yes, thanks to the Clonix receivers. Accessories which accept no limits.



B-EBA

A direct link to your operators.

The B-EBA expansion cards make it possible to connect external devices such as PCs, smartphones and tablets to a BFT operator and a Clonix receiver or to connect multiple BFT products in a U-Link network. These accessories integrate with U-Link technology and with Bluetooth, Wifi, Z-Wave and TCP/IP protocols as well as with the RS485 serial interface. A device that demonstrates exactly what BFT means by interconnectivity.

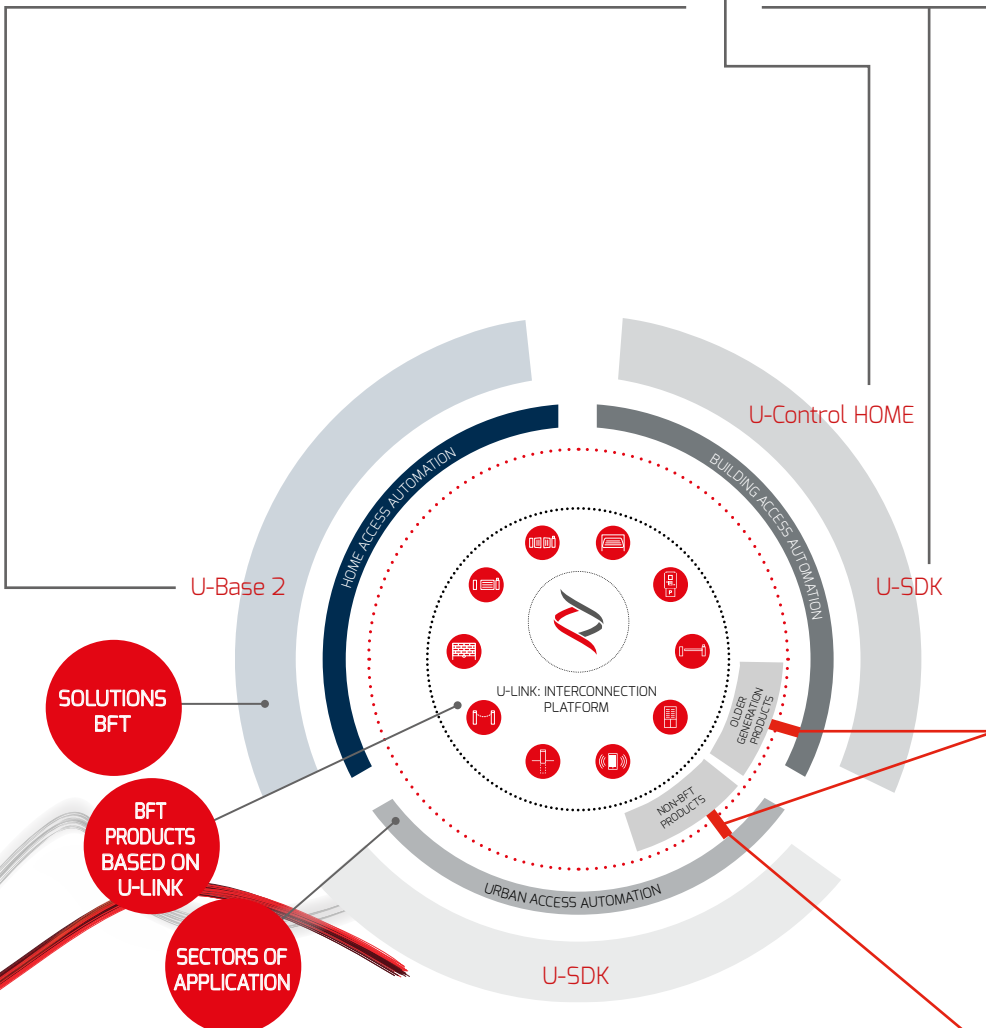

SOLUTIONS BFT

BFT PRODUCTS BASED ON U-LINK

SECTORS OF APPLICATION

