

WIZARDING
WORLD

Harry Potter



hidden forest forbidden



HOGWARTS SCHOOL
EQUIPMENT BOOK LIST

3D
PUZZLE

CONTACT
IF YOU HAVE

MAGICAL
FEATURES

YOU-KNOW-WHO'S
MANTLE

71
PCS

8+

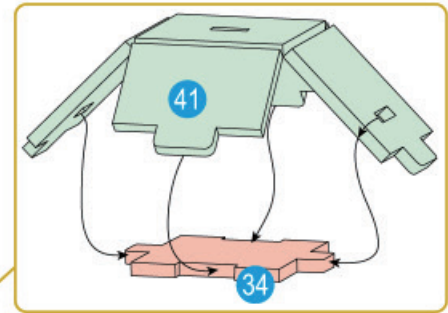
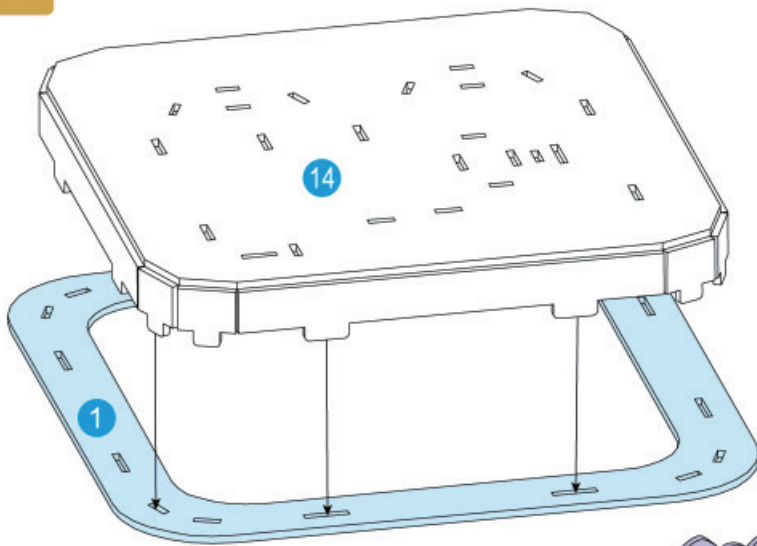
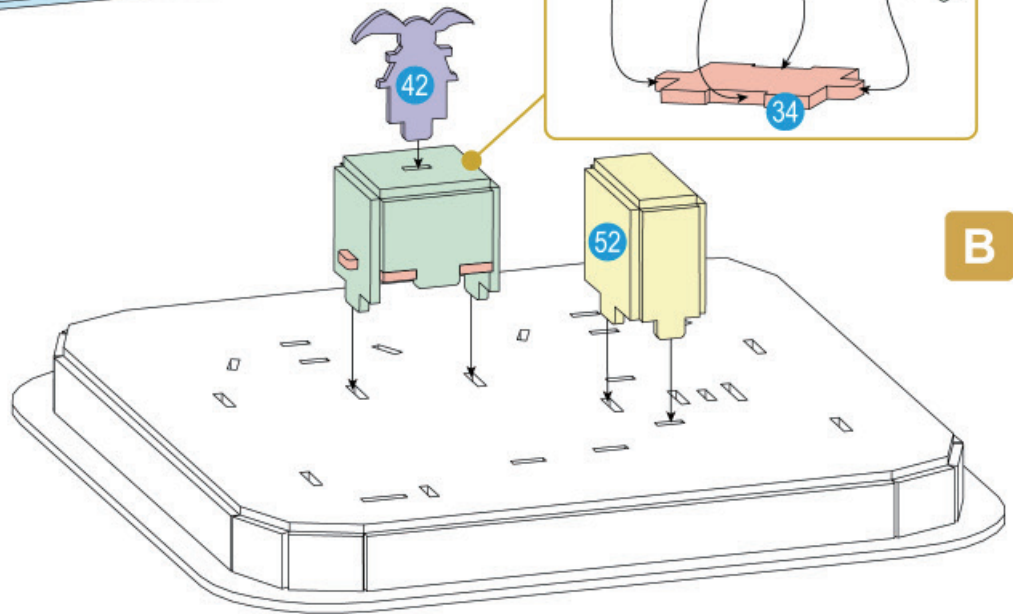
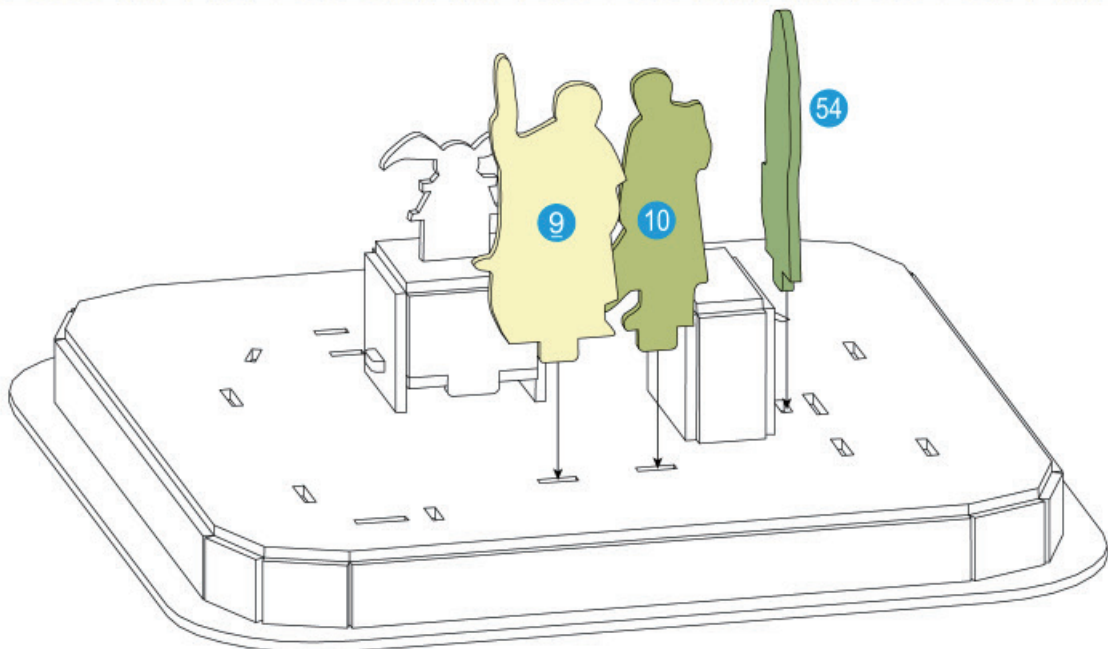

QUALITY QUIDDITCH SUPPLIES™ | 3D Puzzle

A**B****C**

Small text at the bottom of the page, likely a copyright notice or disclaimer, partially obscured by the page edge.

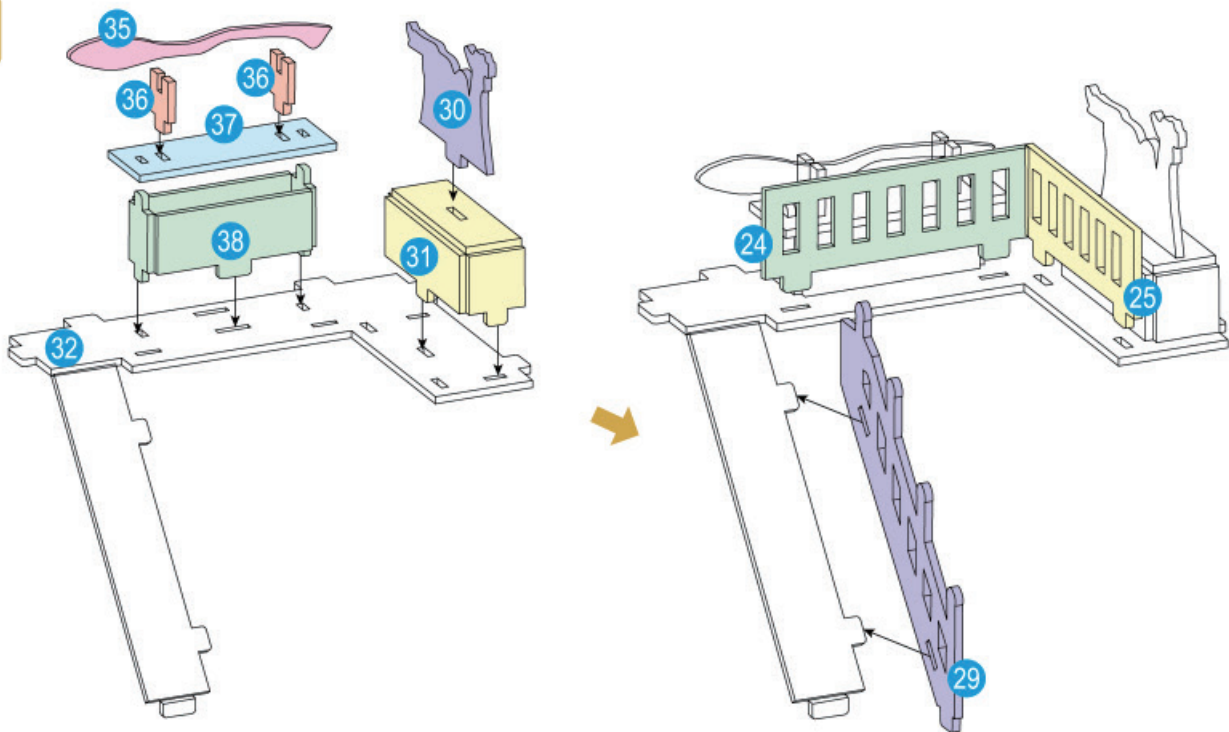
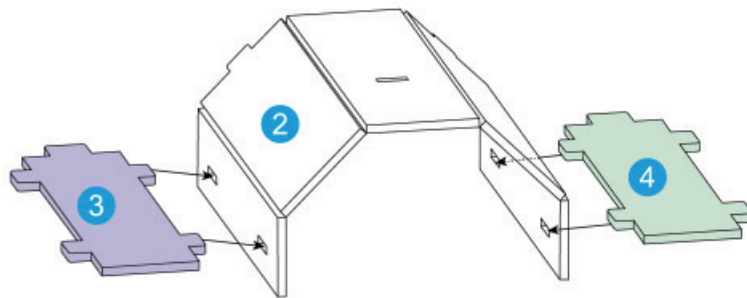
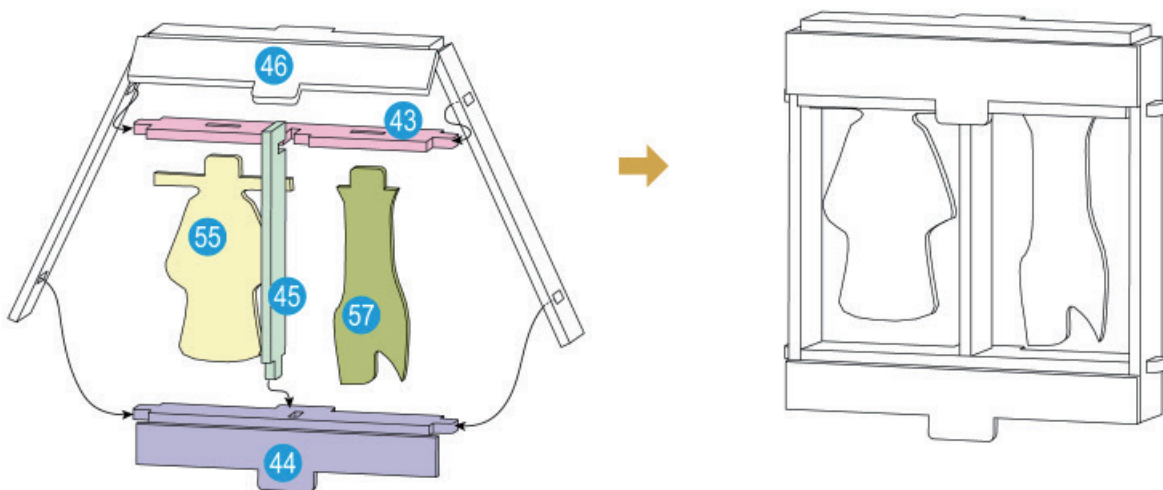
D**E****F**

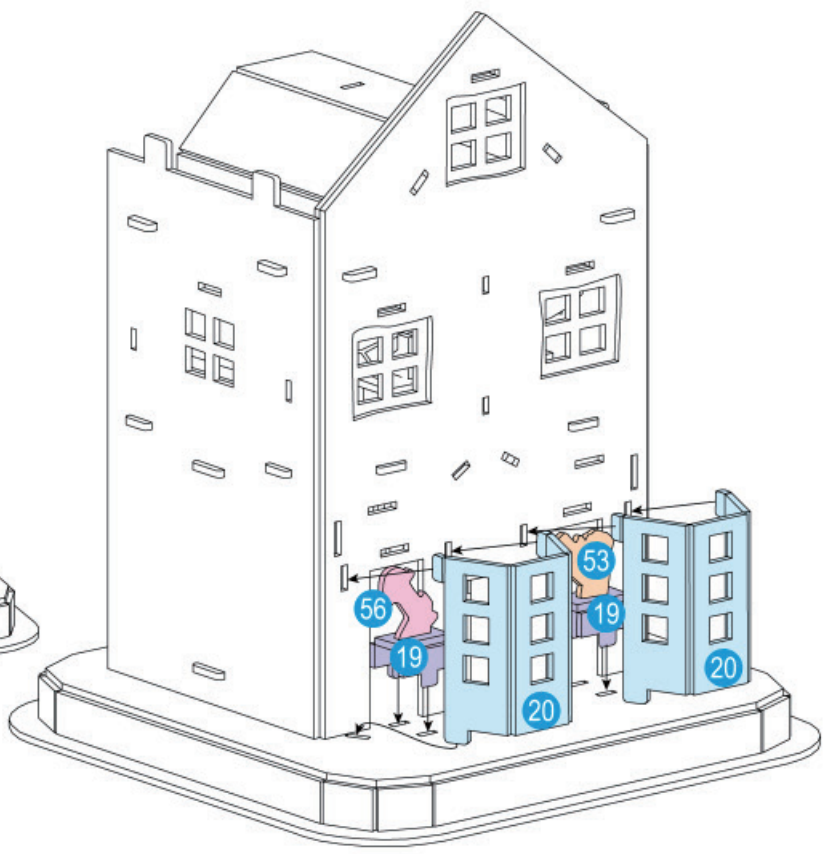
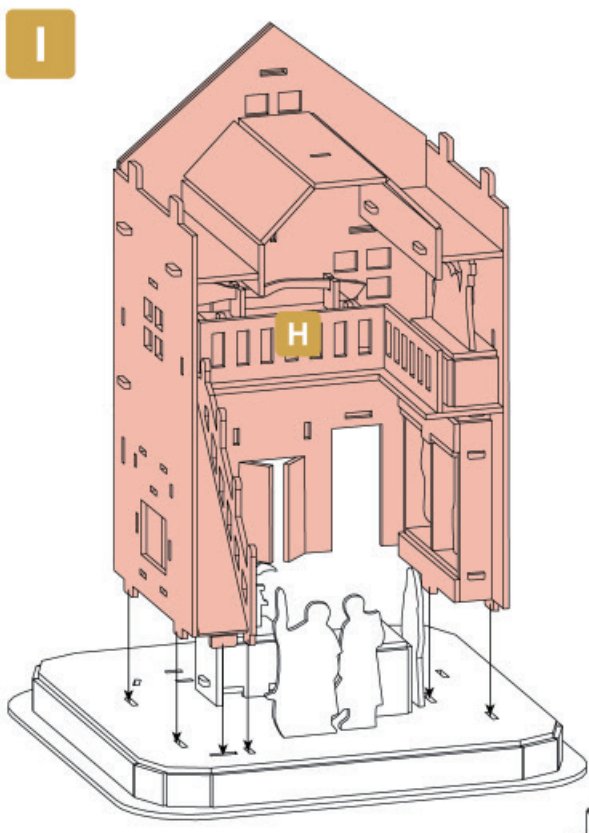
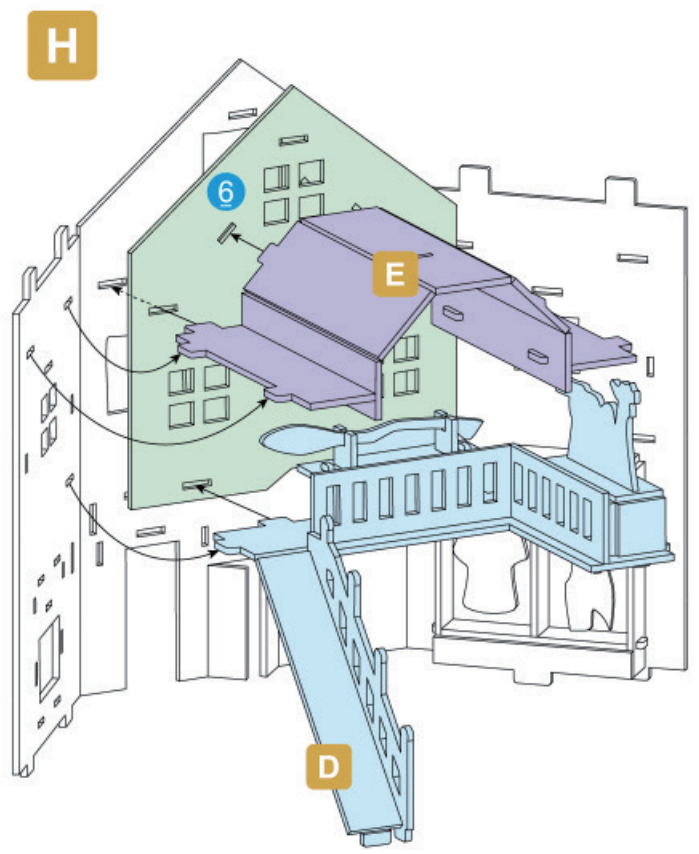
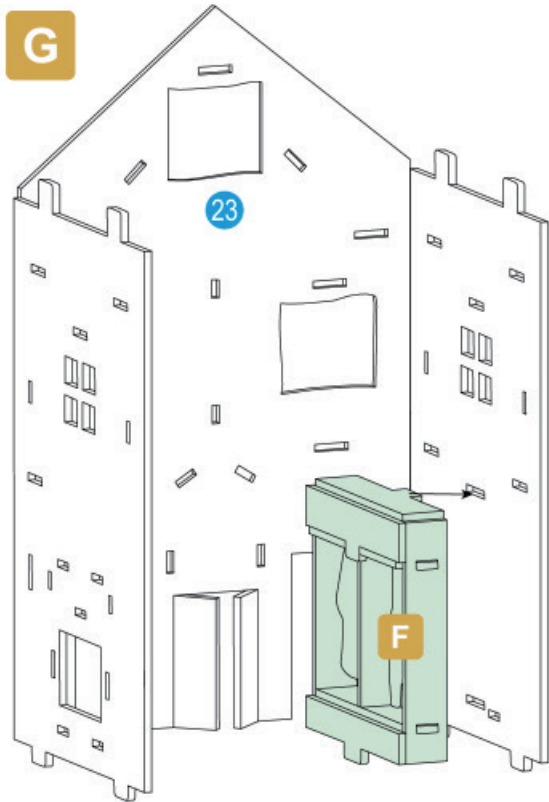

J



K

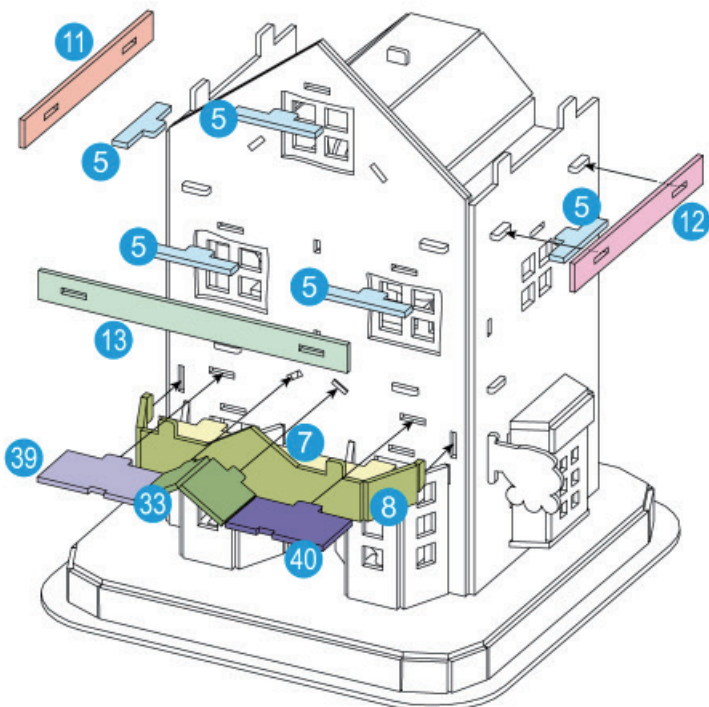

L

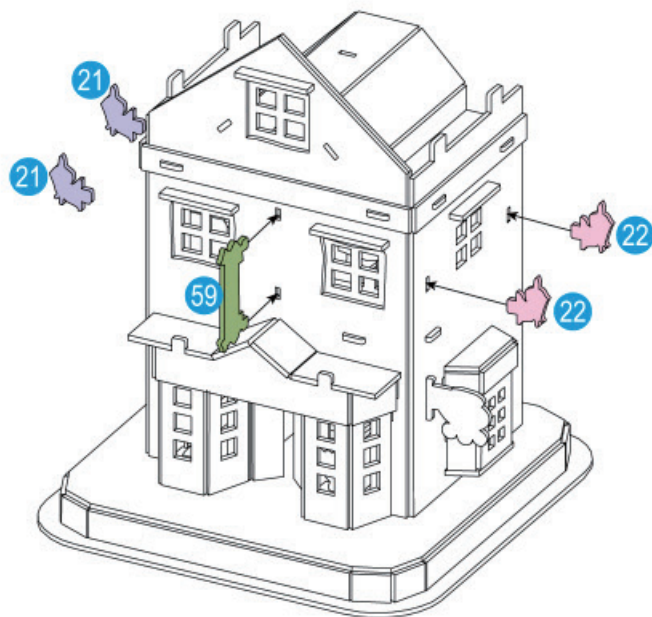

M

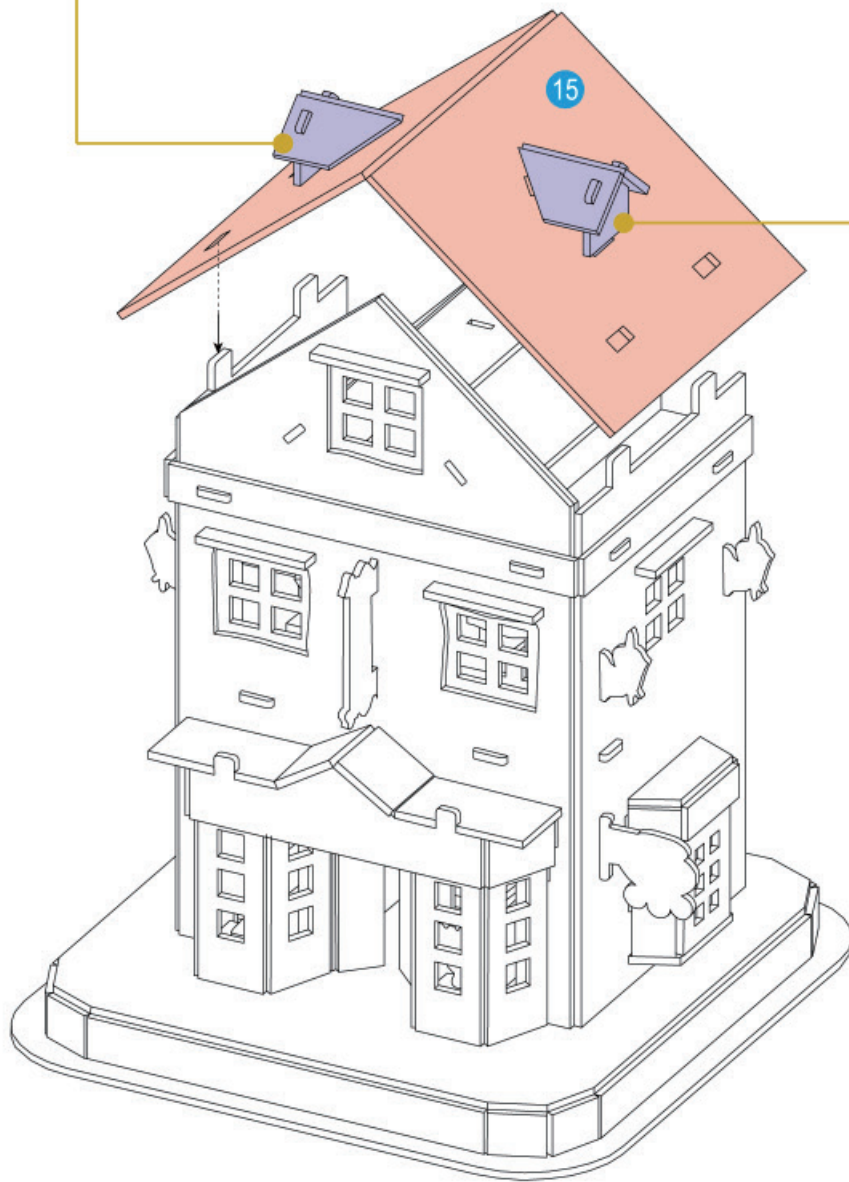
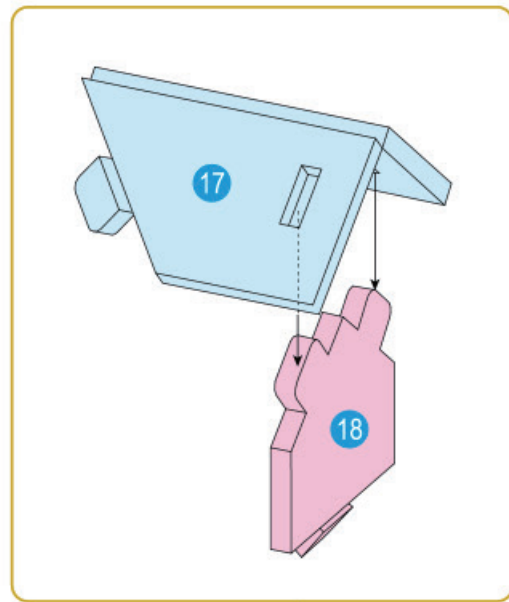
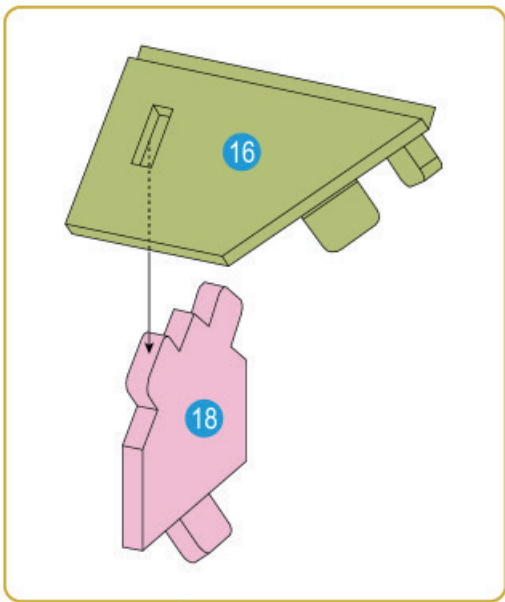

N

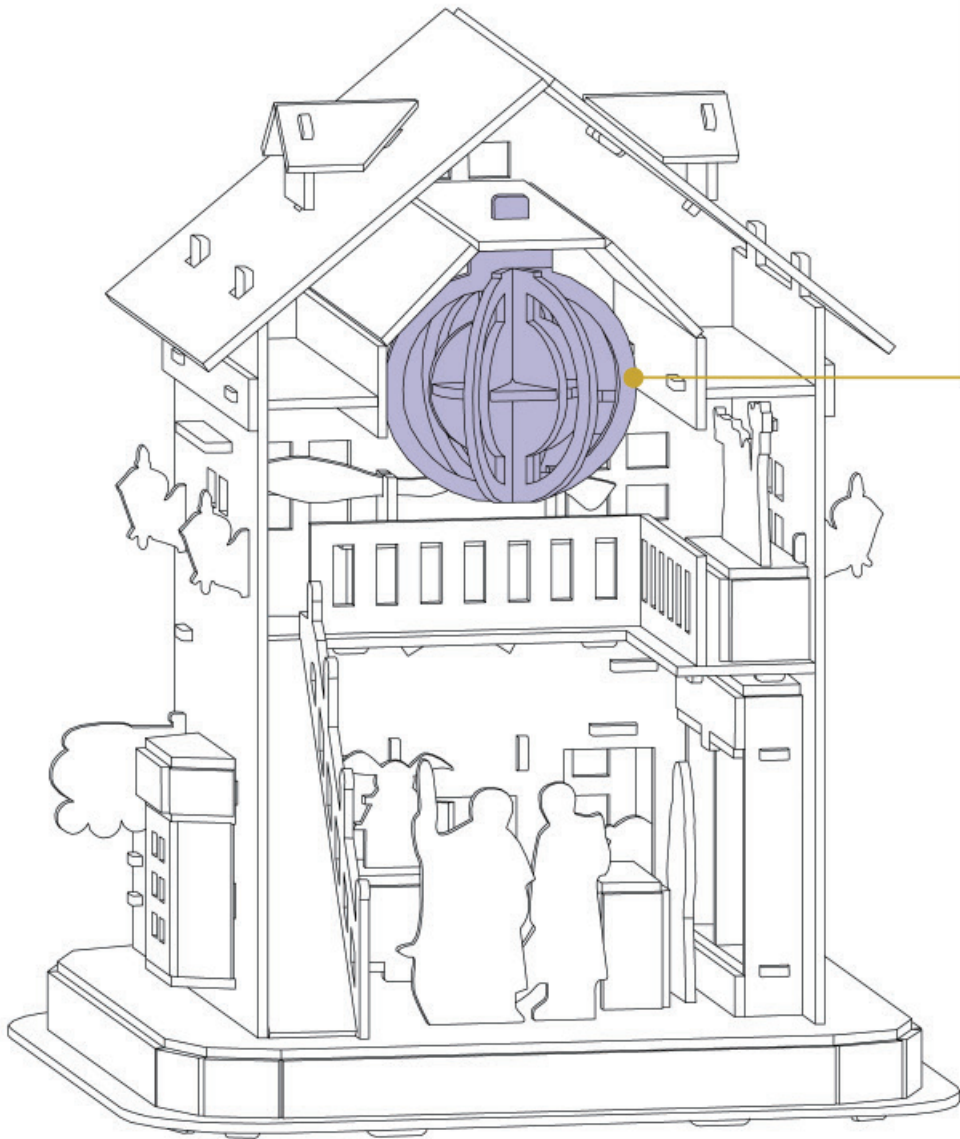
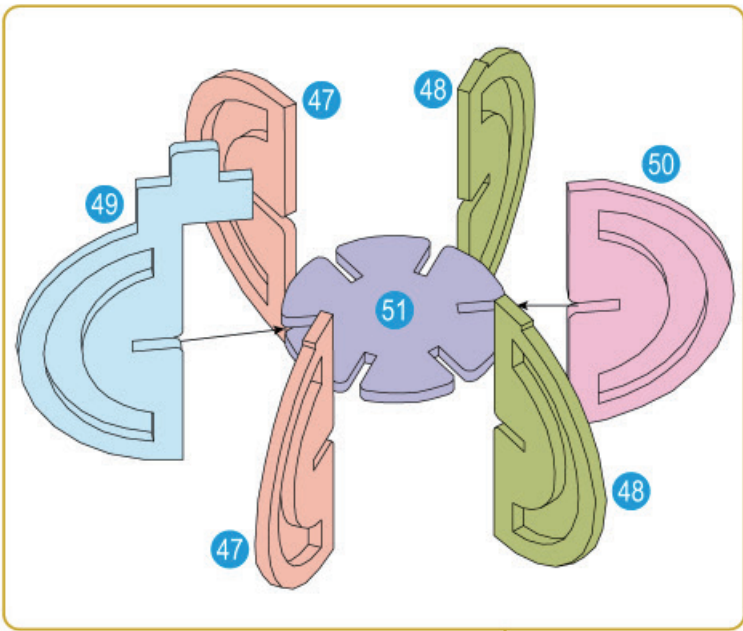

Forbidden forest forbidden

THE MINISTRY OF MAGIC NY INFORMATION

Historic in the...
 You are invited to...
 The Ministry of Magic...
 See page 4 for more information.



U.S. ...
 ...



The price for each...
 ...
 ...

MAGICAL CREATURES

...
 ...
 ...

...
 ...
 ...

...
 ...
 ...