

WIZARDING
WORLD

Harry Potter



hidden forest forbidden



3D
PUZZLE

CONTACT

IF YOU HAVE ANY

MAGICAL
FEATURES

YOU KNOW WHO'S
THEY ARE

197
PCS

8+

HOGWARTS™ CASTLE |

3D Puzzle



A.1

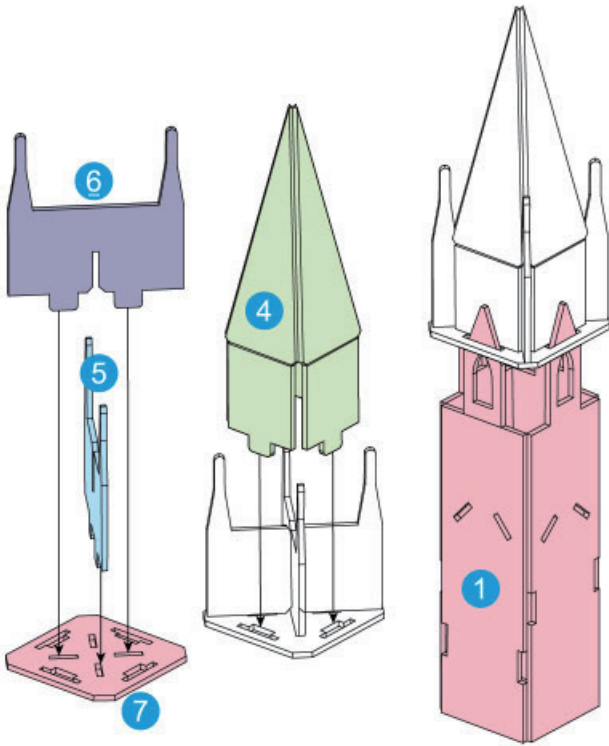

A.2

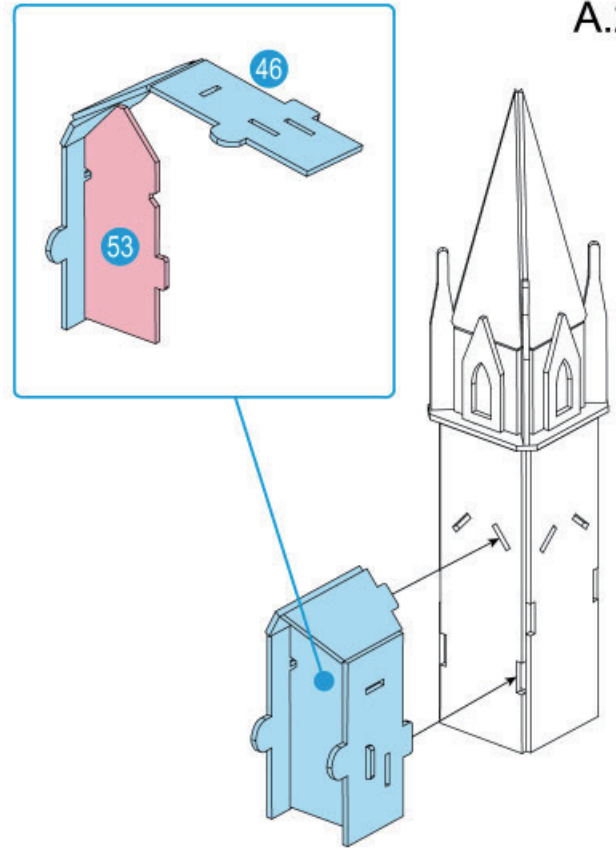

A.3

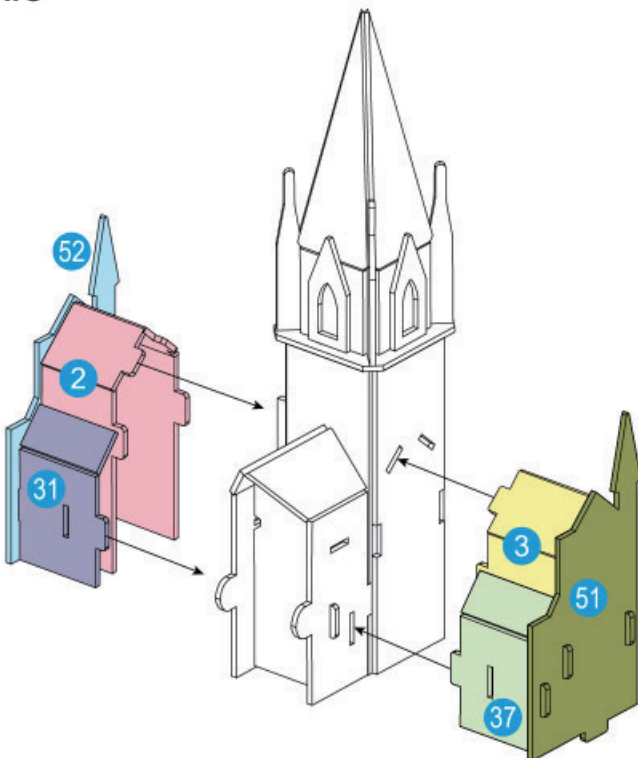

A.4

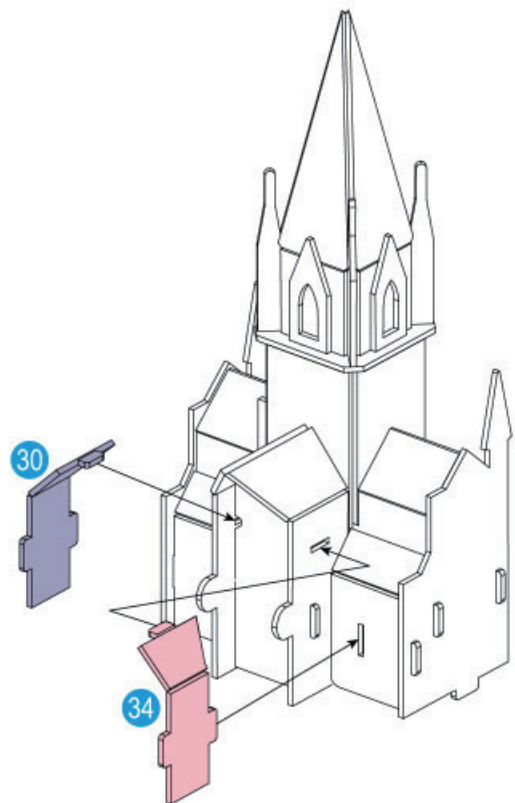

C.1

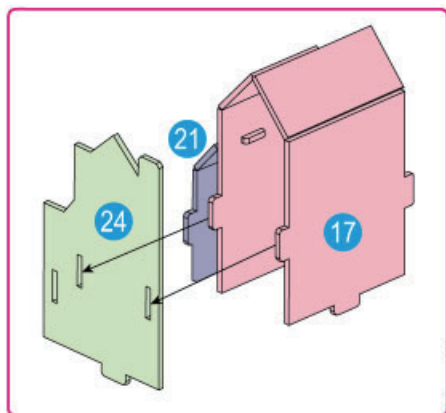
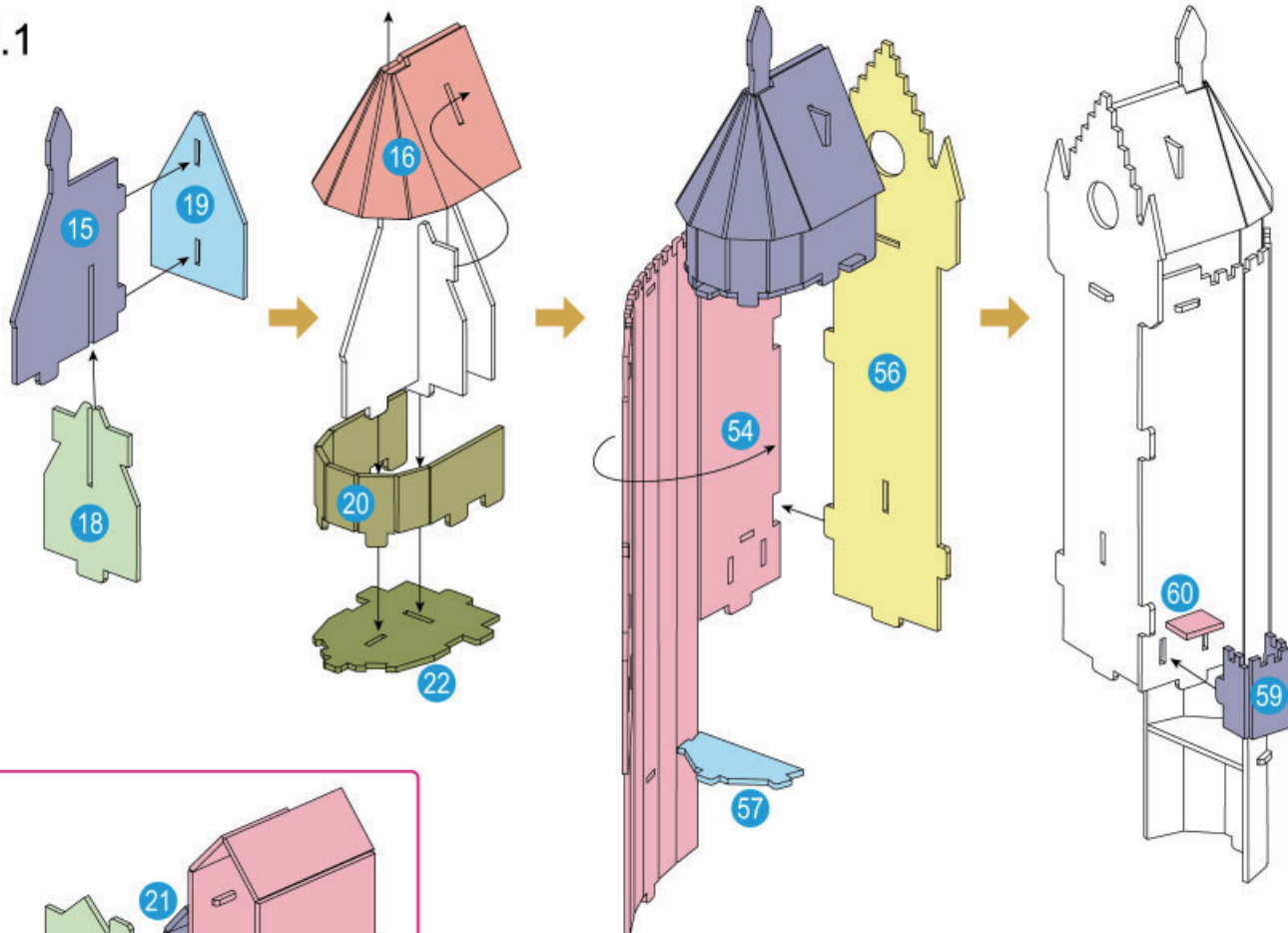

C.2

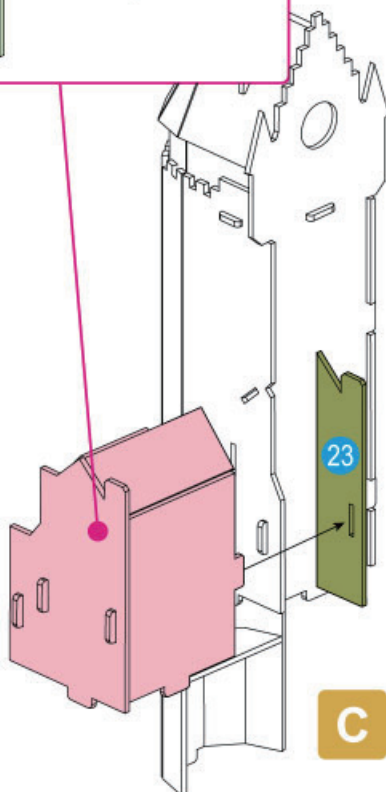

C

D.1

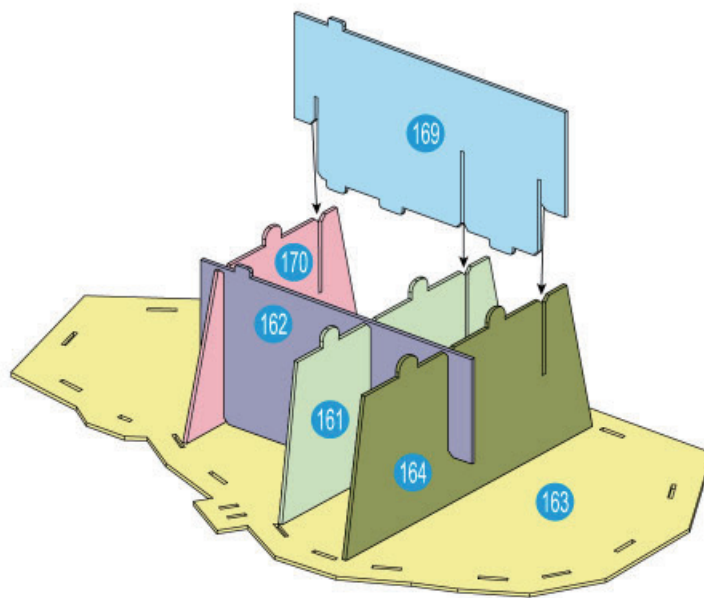

D.2

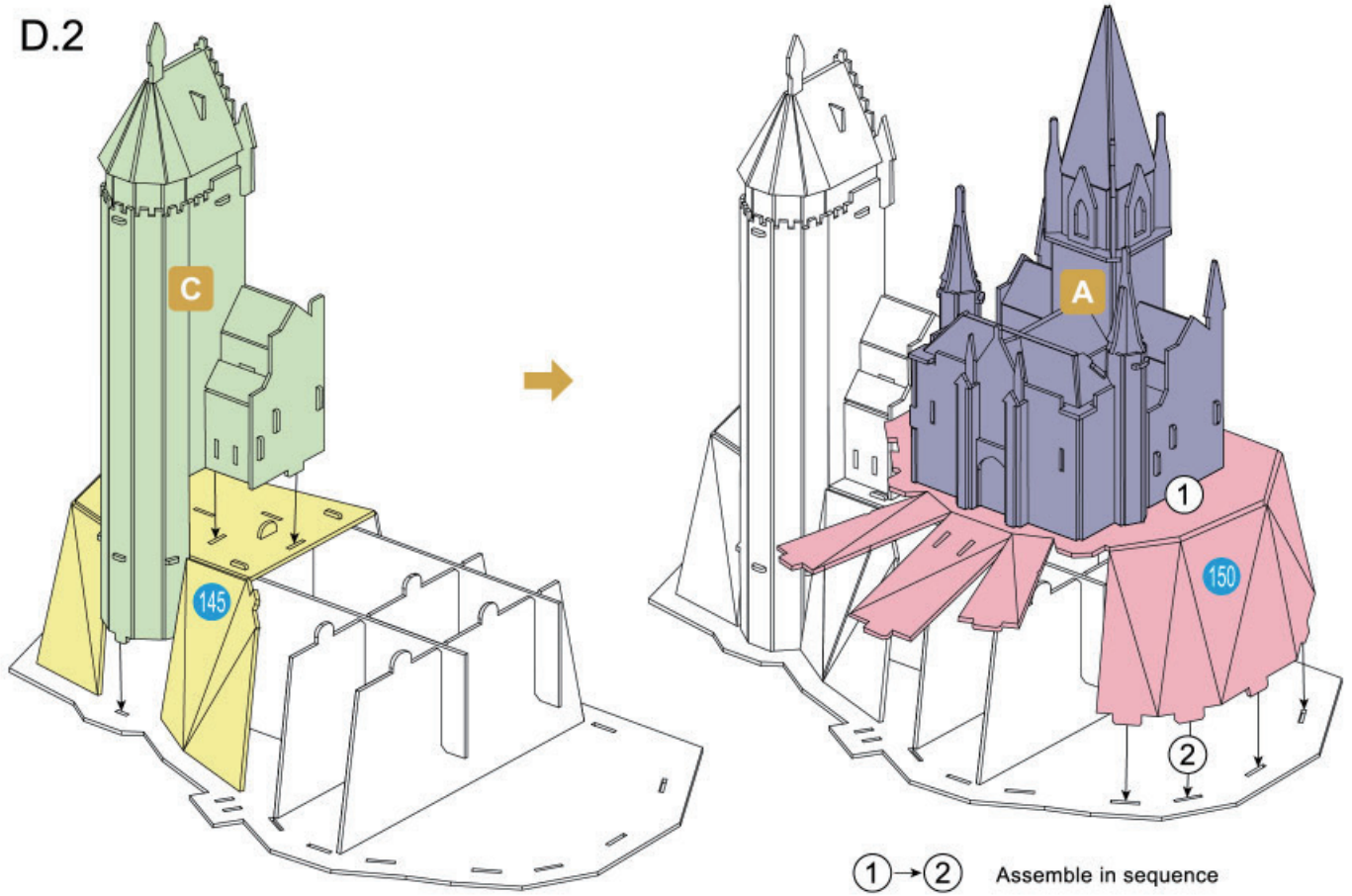

D.3

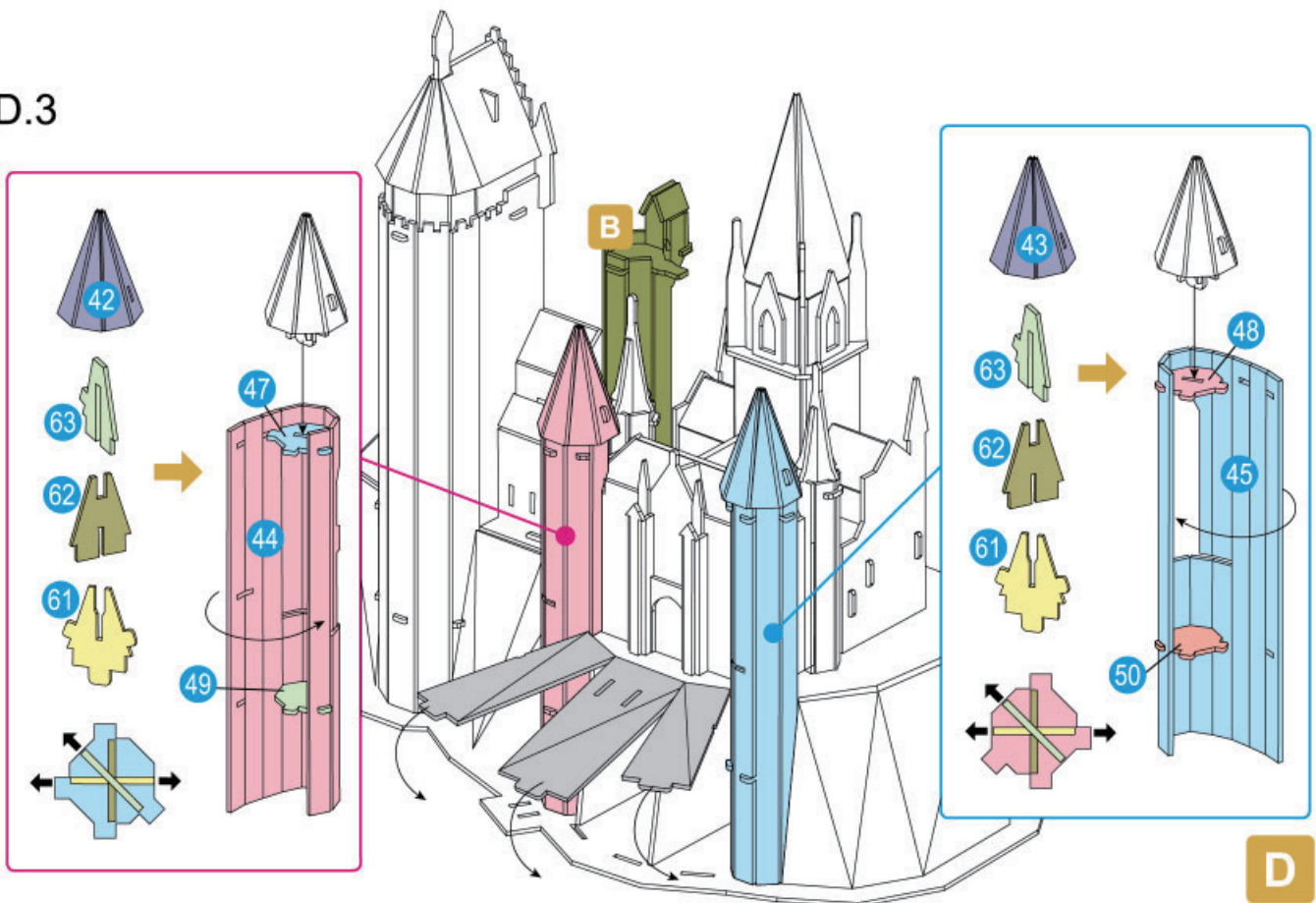

E.1

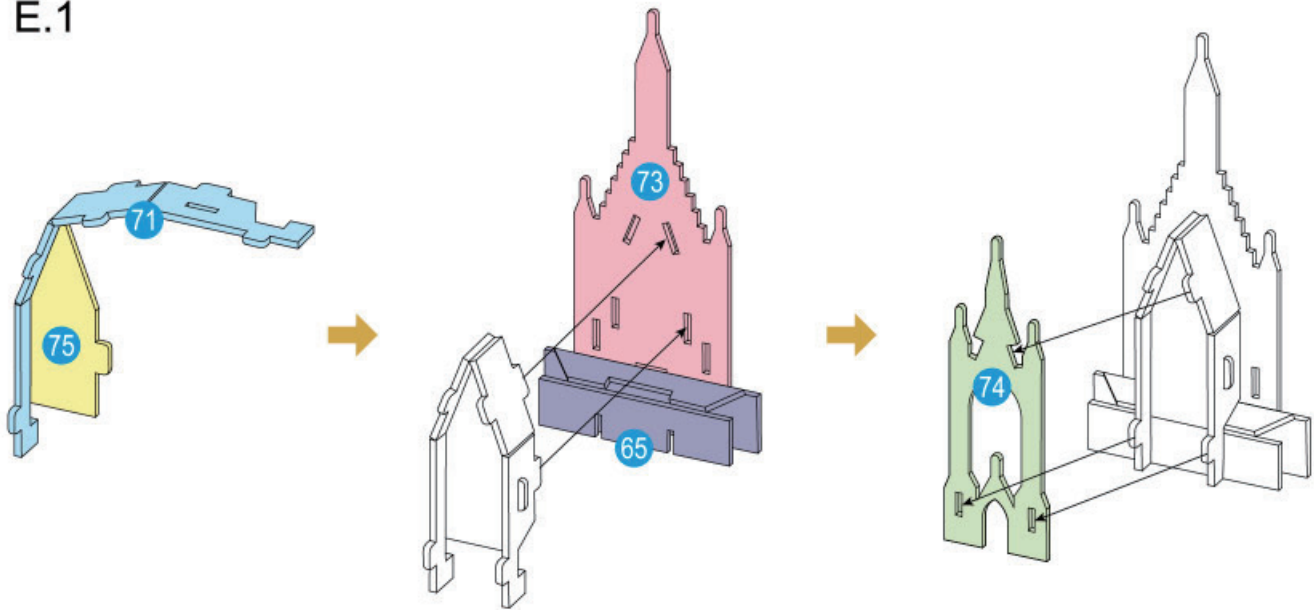

E.2

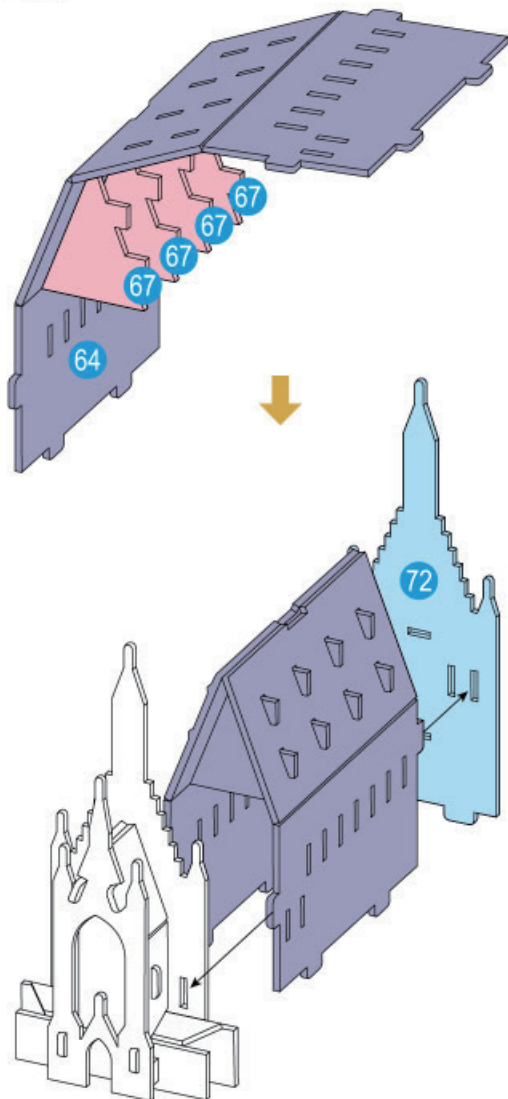

E.3

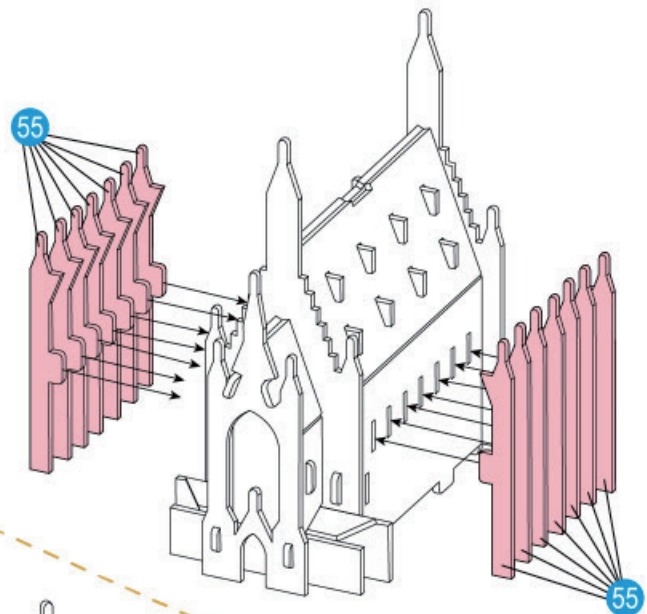

E.4

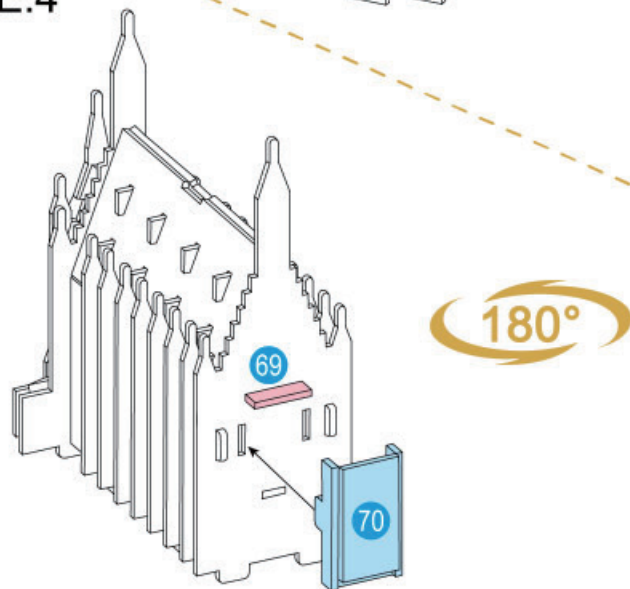

E.5

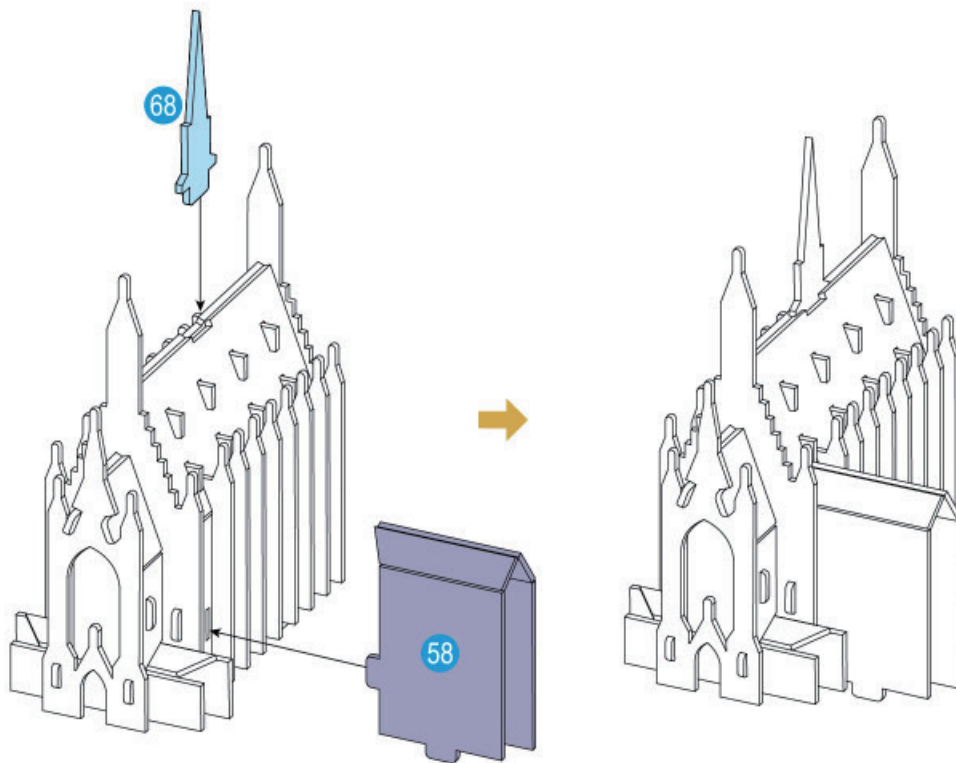

E

F.1

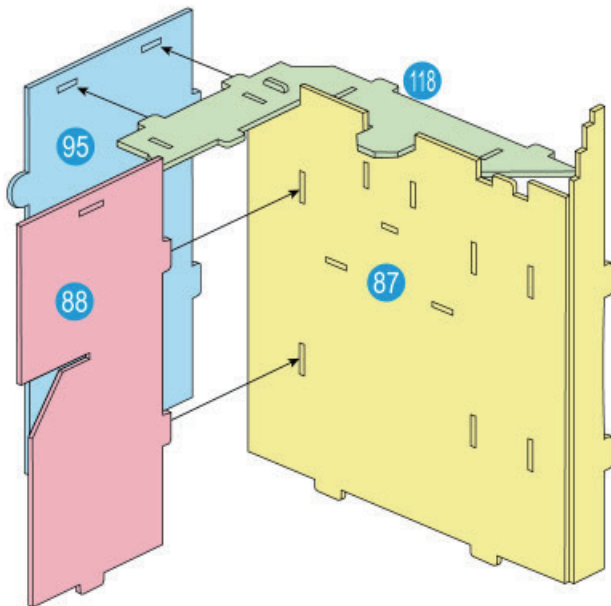

F.2

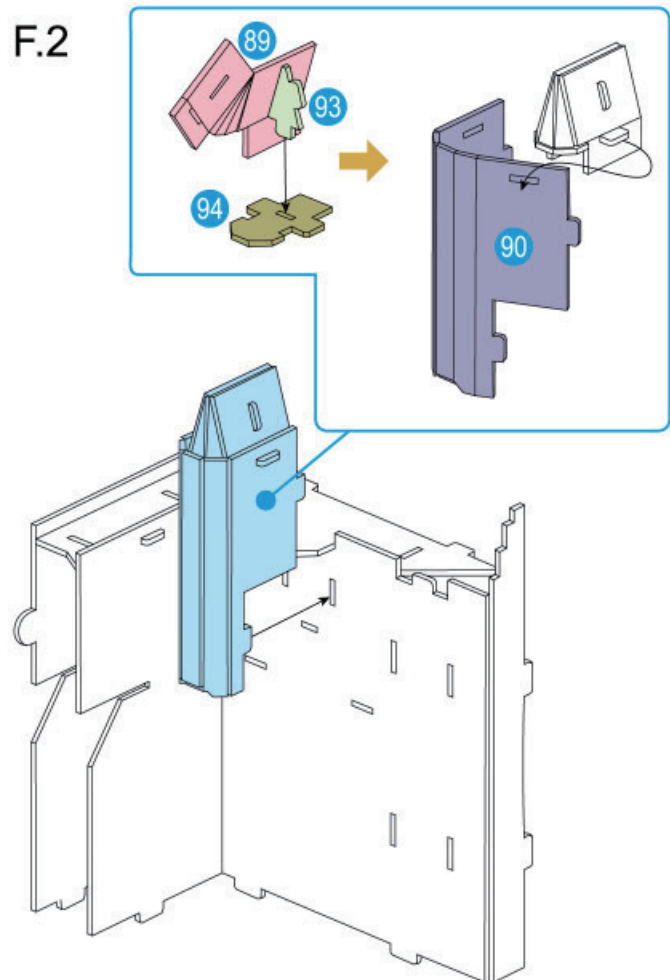

E

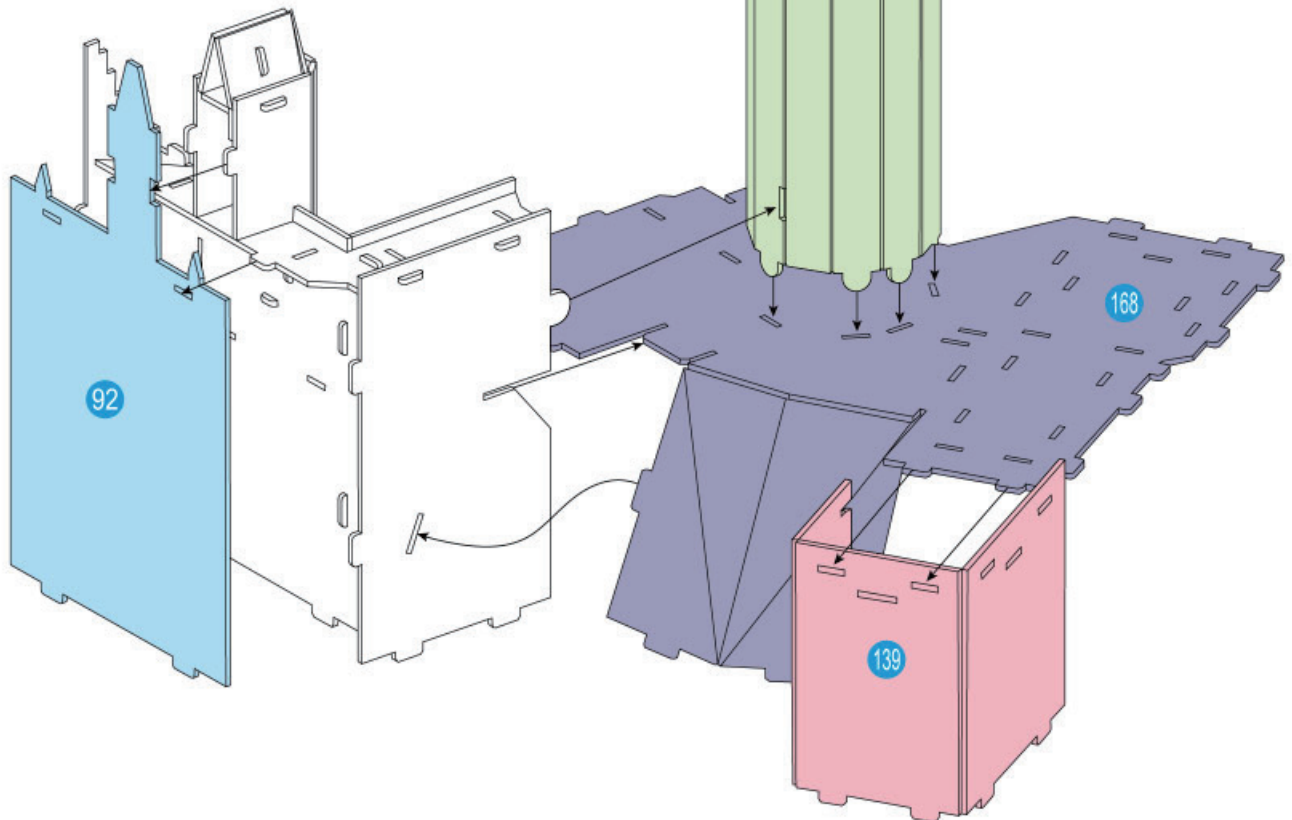
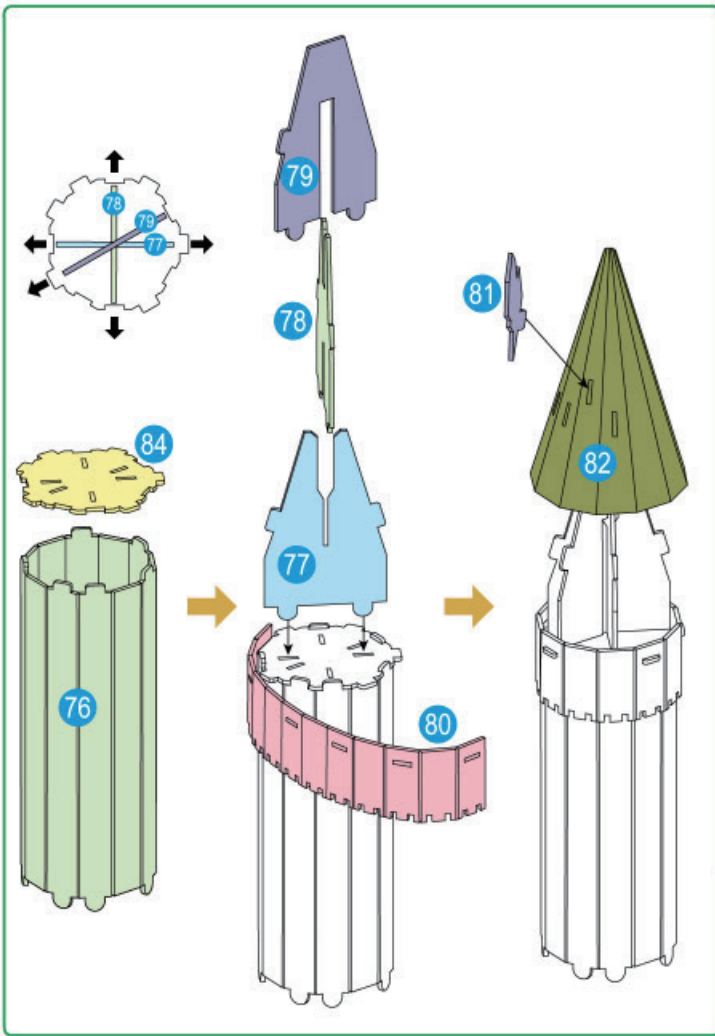

F.4

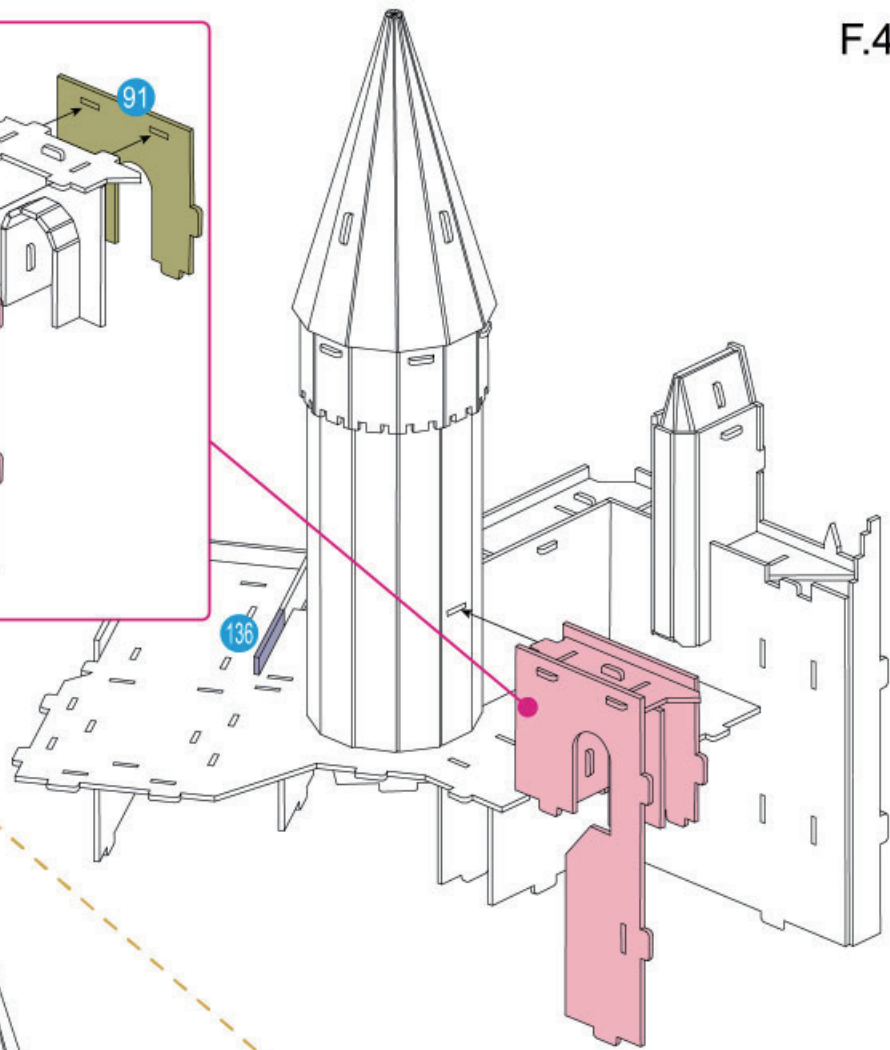
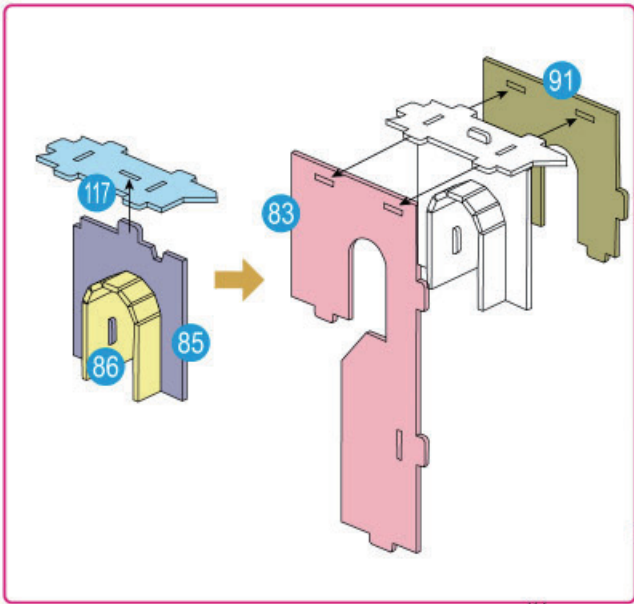

F.5

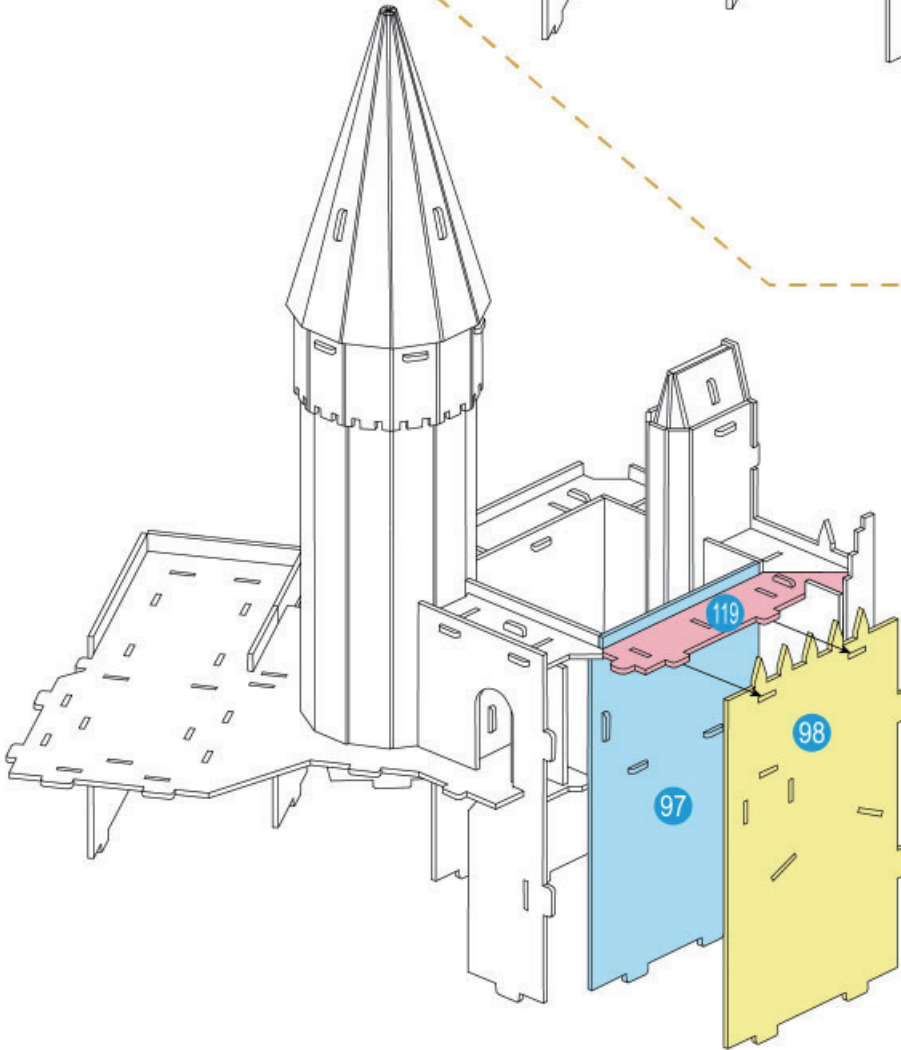

F.6

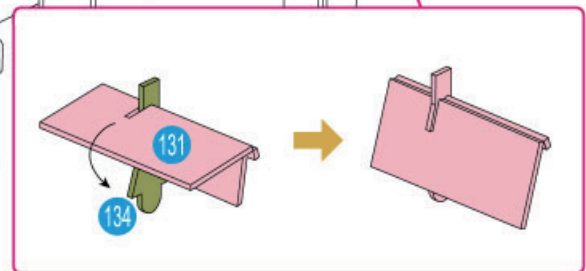
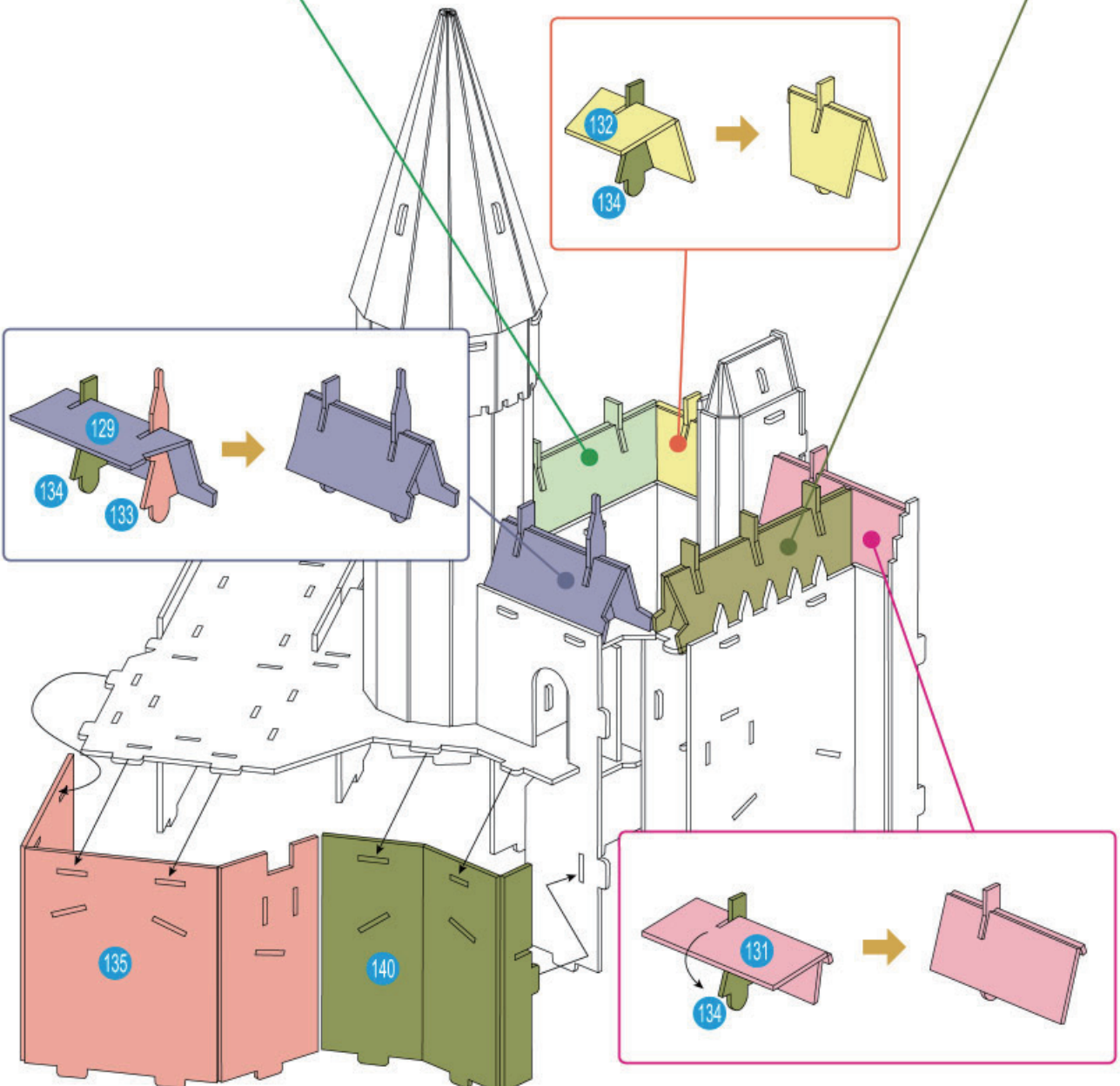
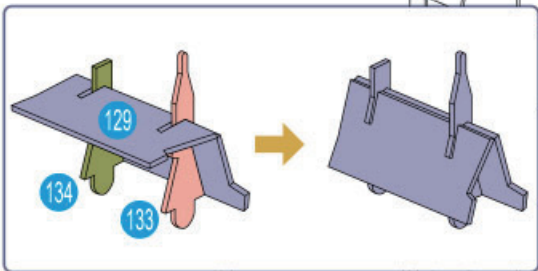
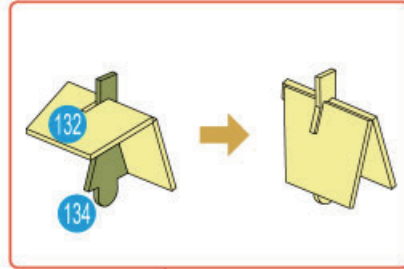
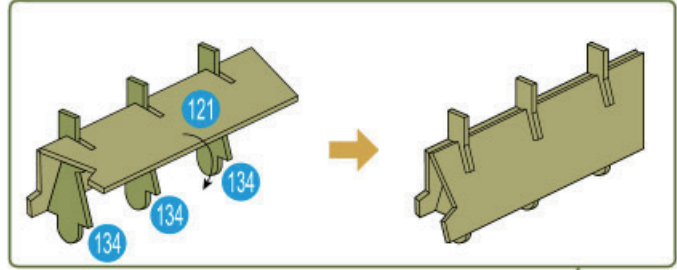
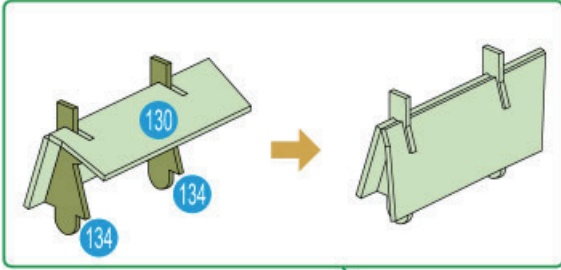

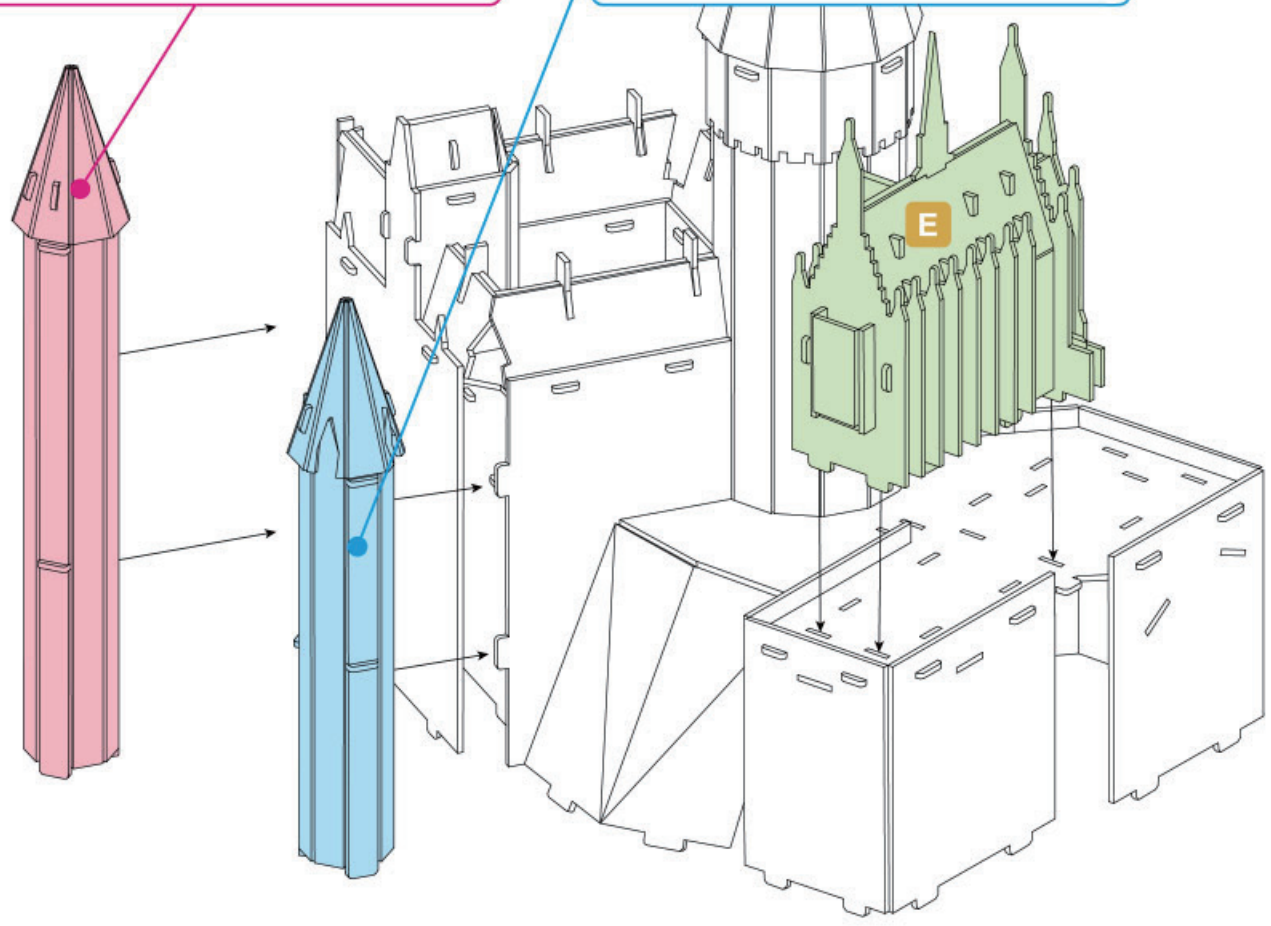
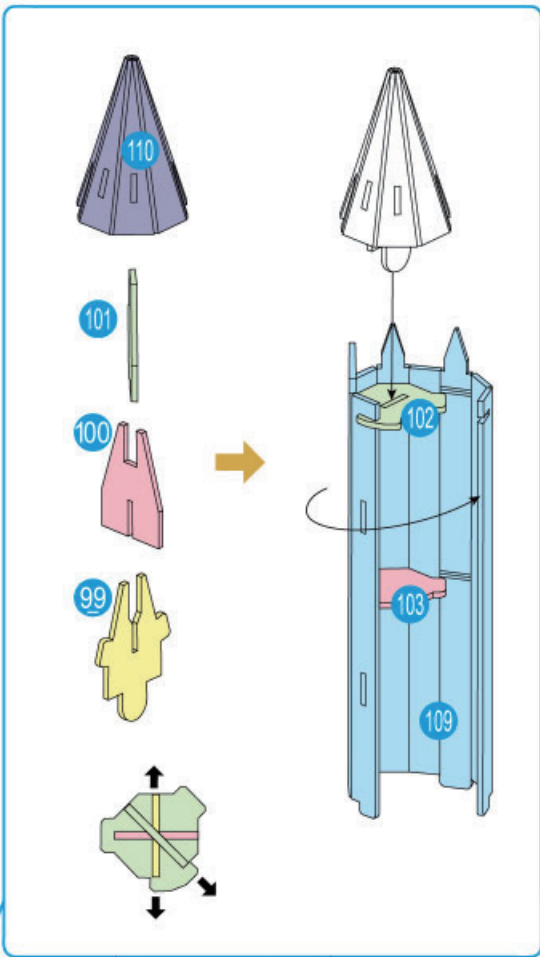
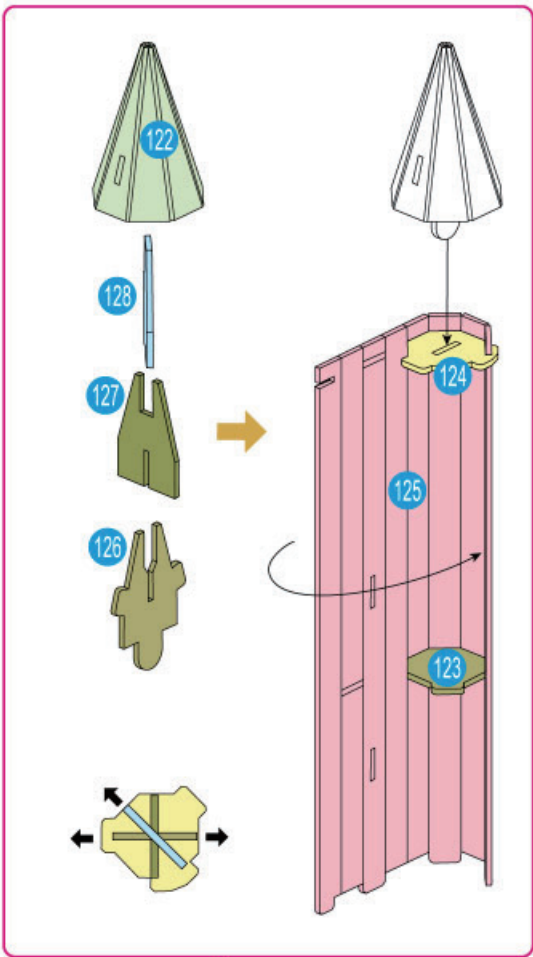

F.9

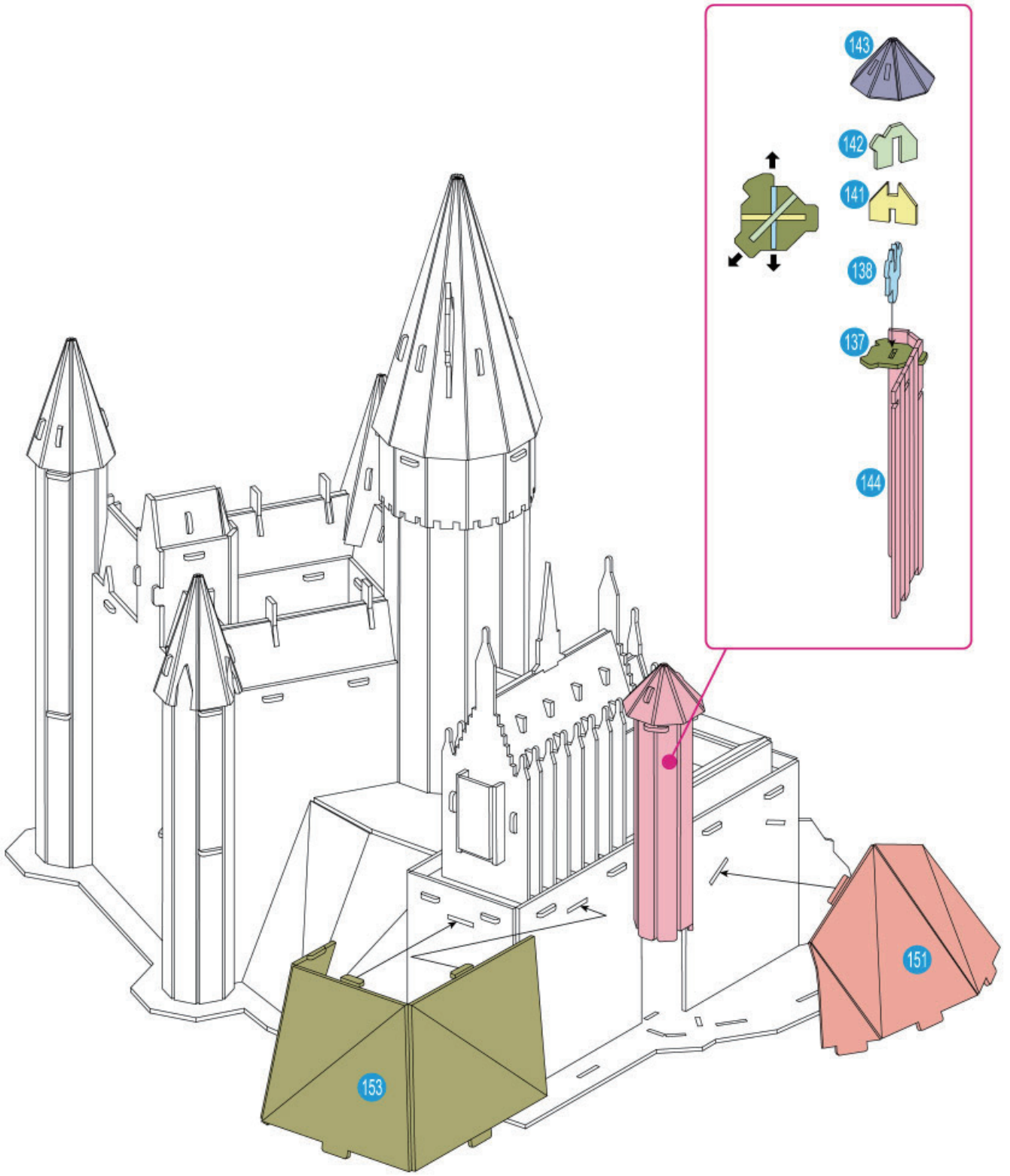

143

142

141

138

137

144

153

151

F.10

F

