

WIZARDING
WORLD

Harry Potter



hidden forest forbidden



3D
PUZZLE

CONTACT THE MINISTER
IF YOU HAVE ANY INFORMATION

MAGICAL
CREATURES

YOU-KNOW-WHO'S
HAPPENEVER



101
PCS

8+

HAGRID'S HUT | 3D Puzzle

Hagrid's Hut™



X 1

p 1/5



1

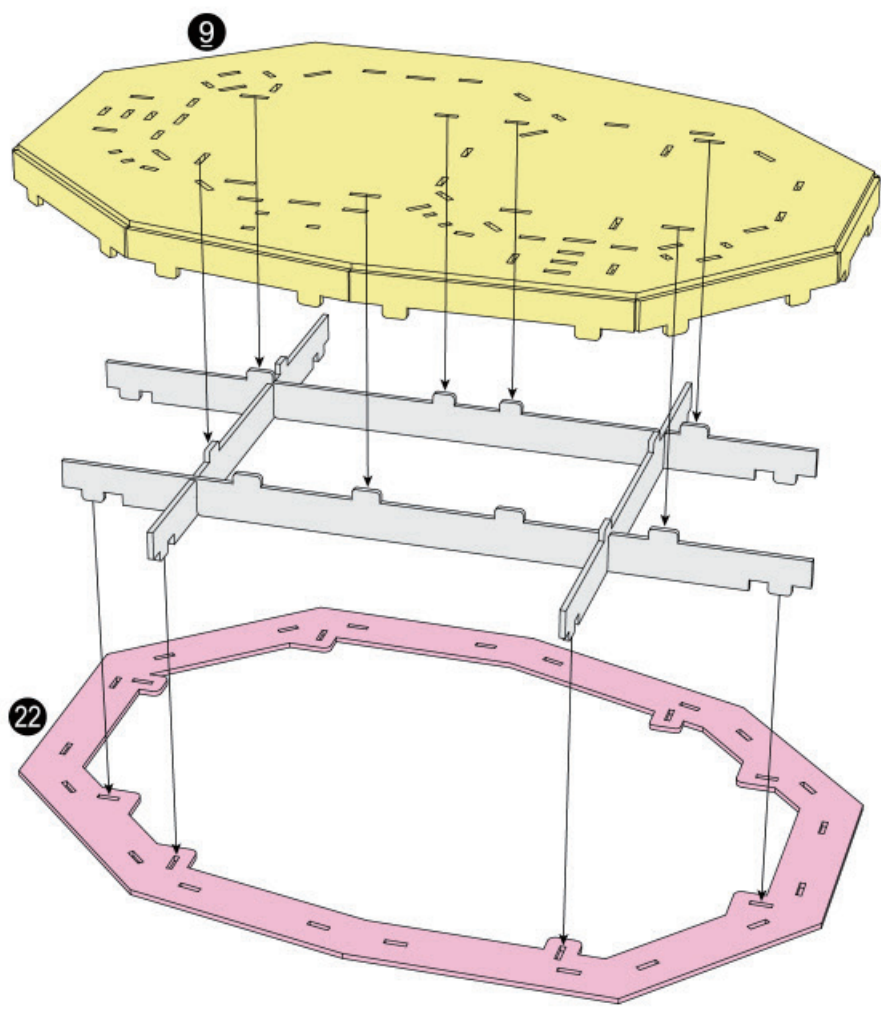
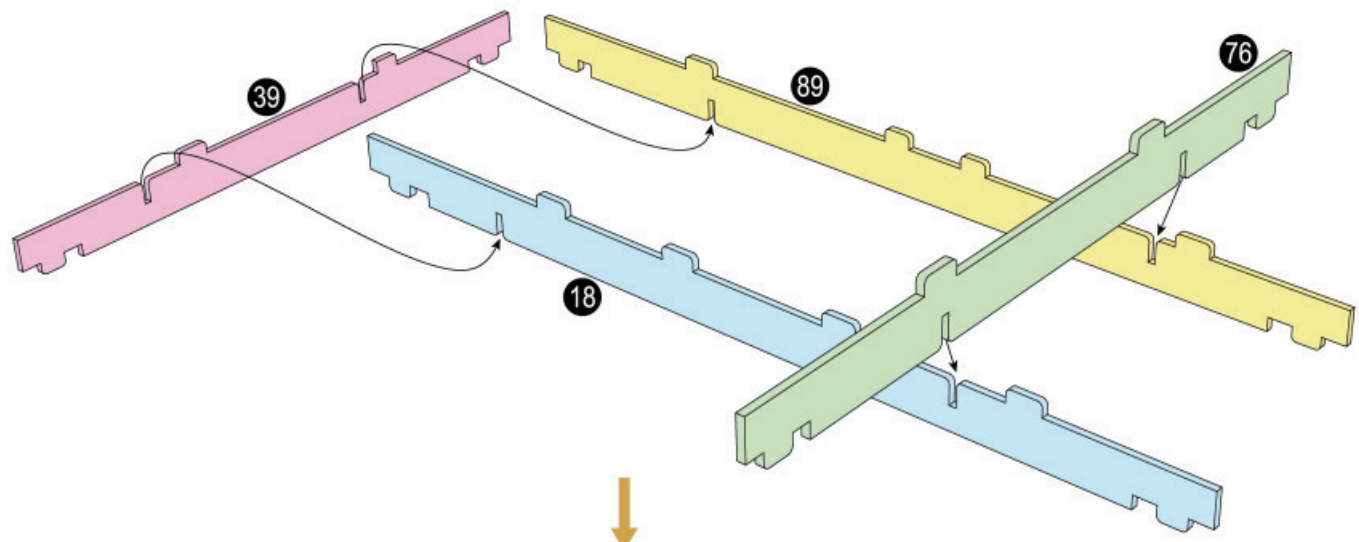

2

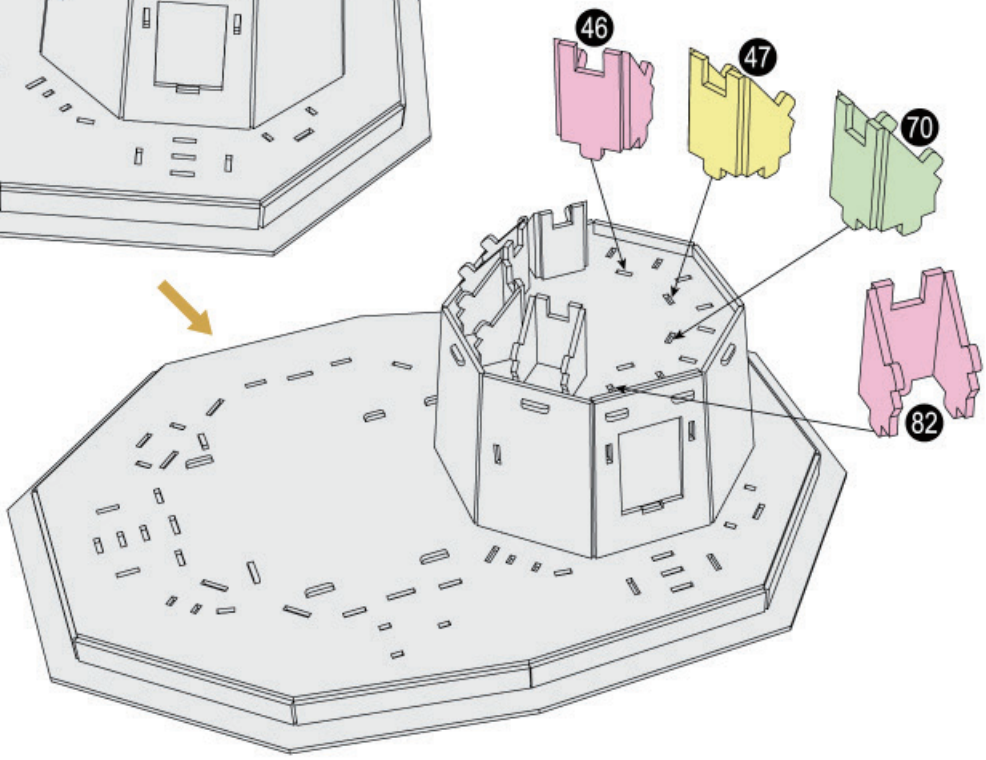
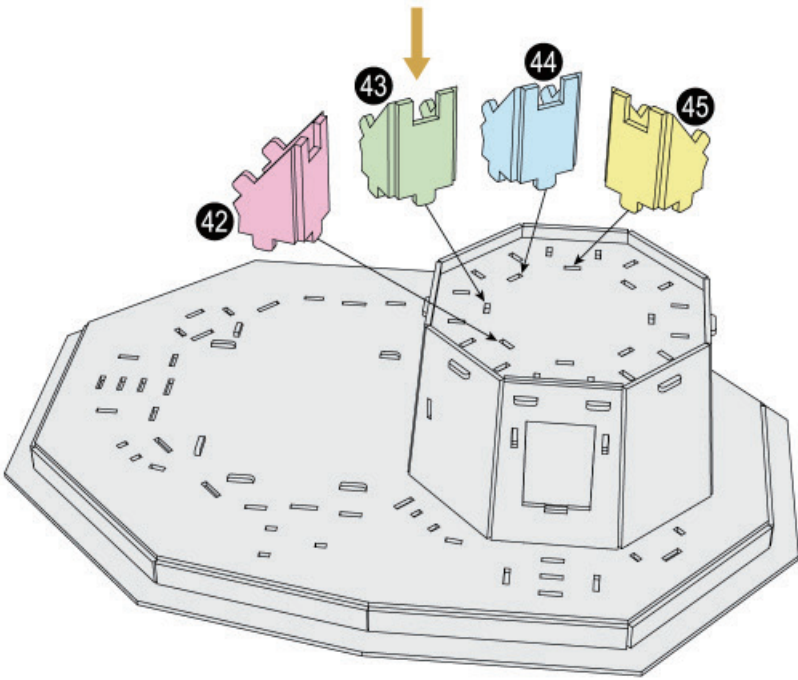
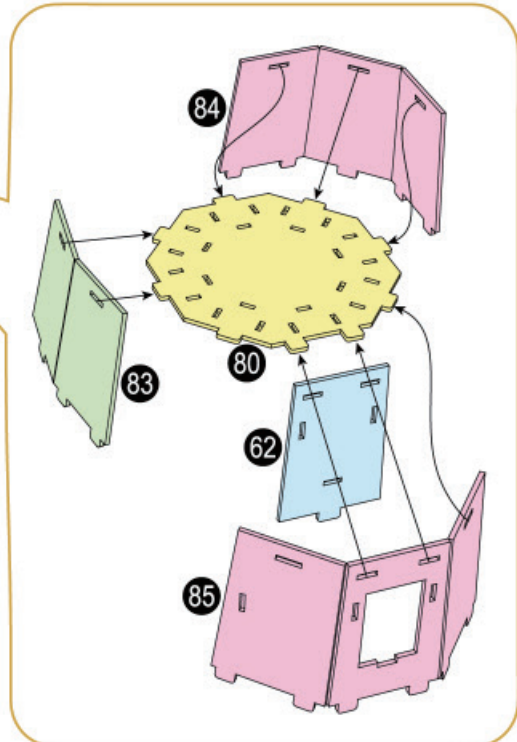
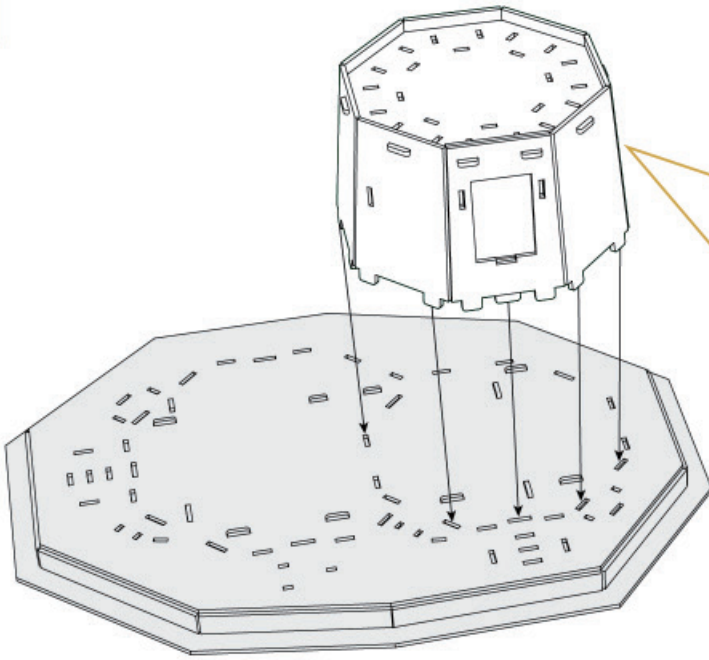

3

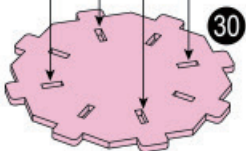
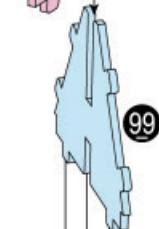
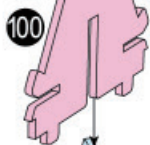
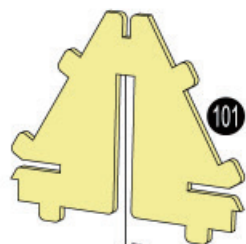
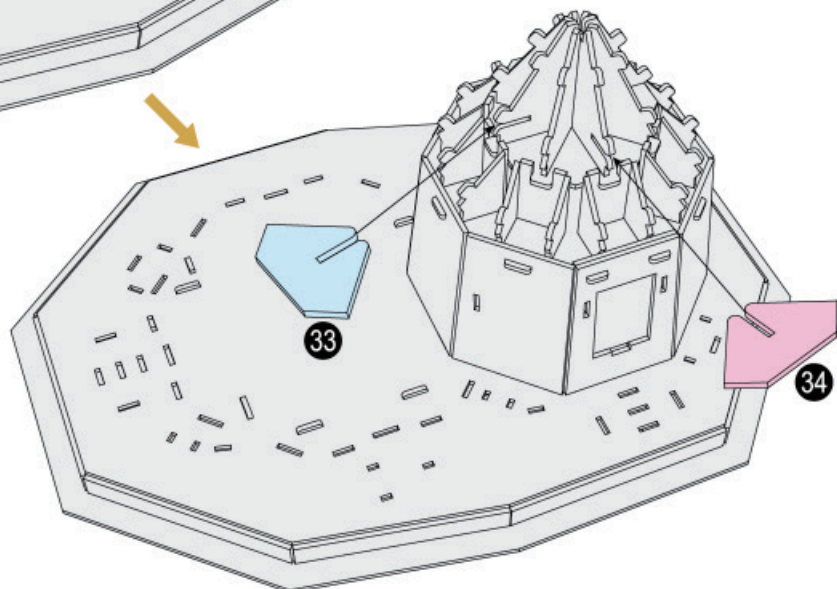
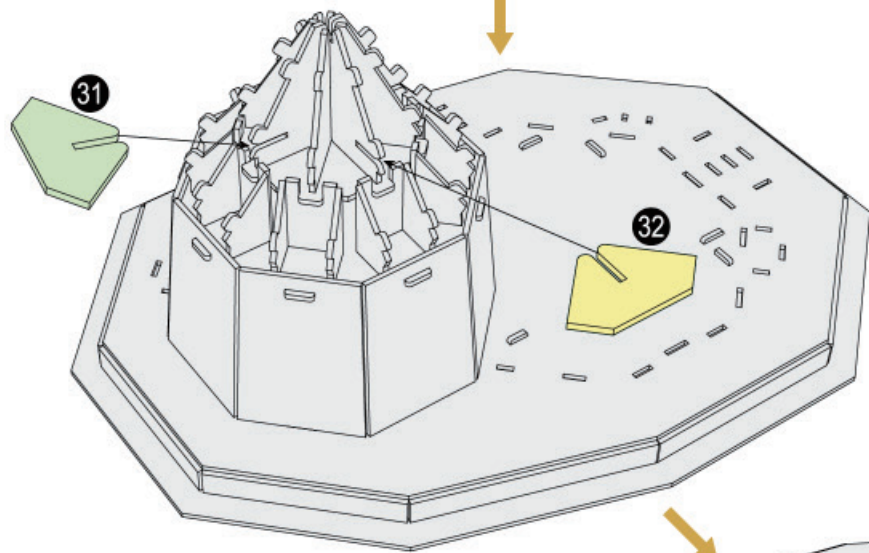
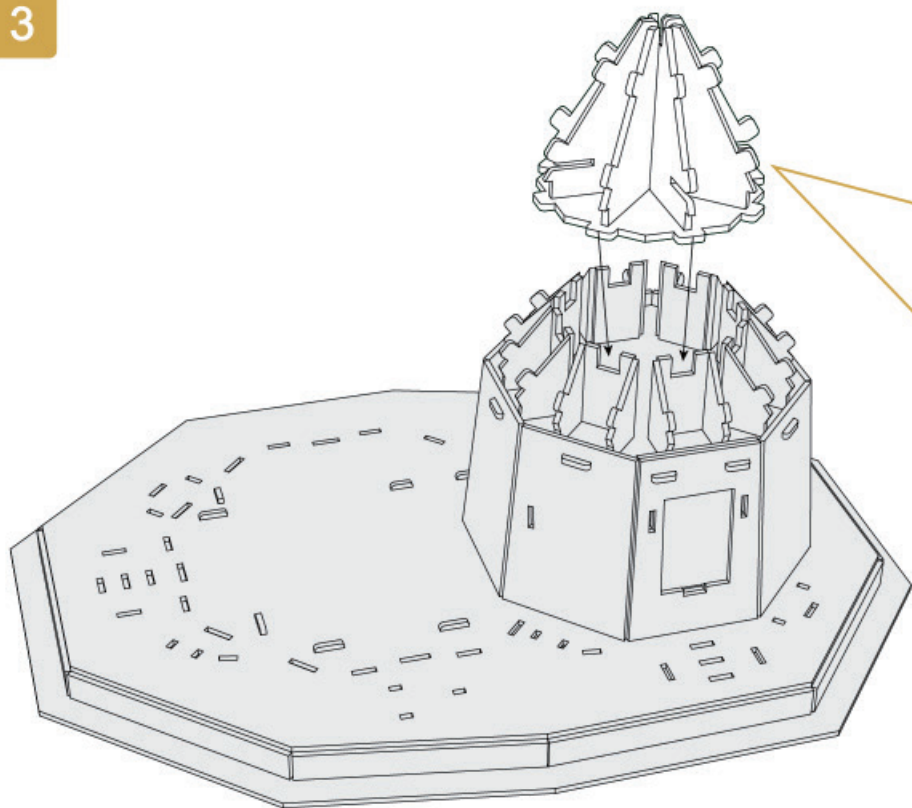

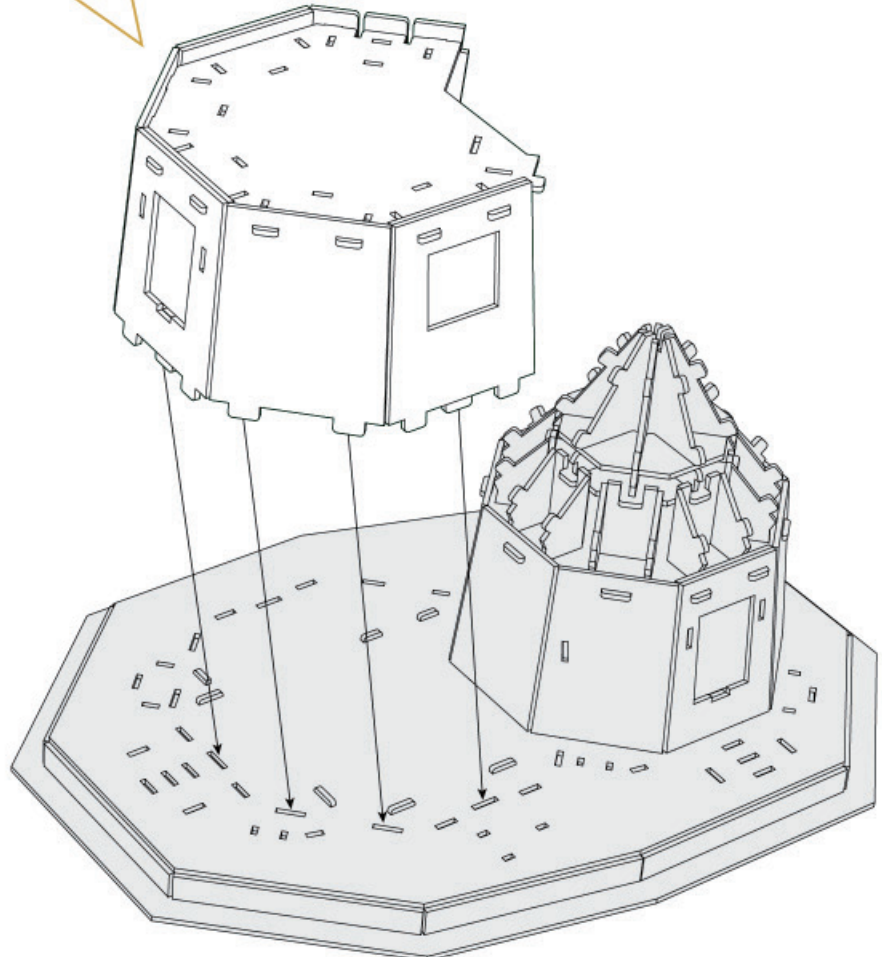
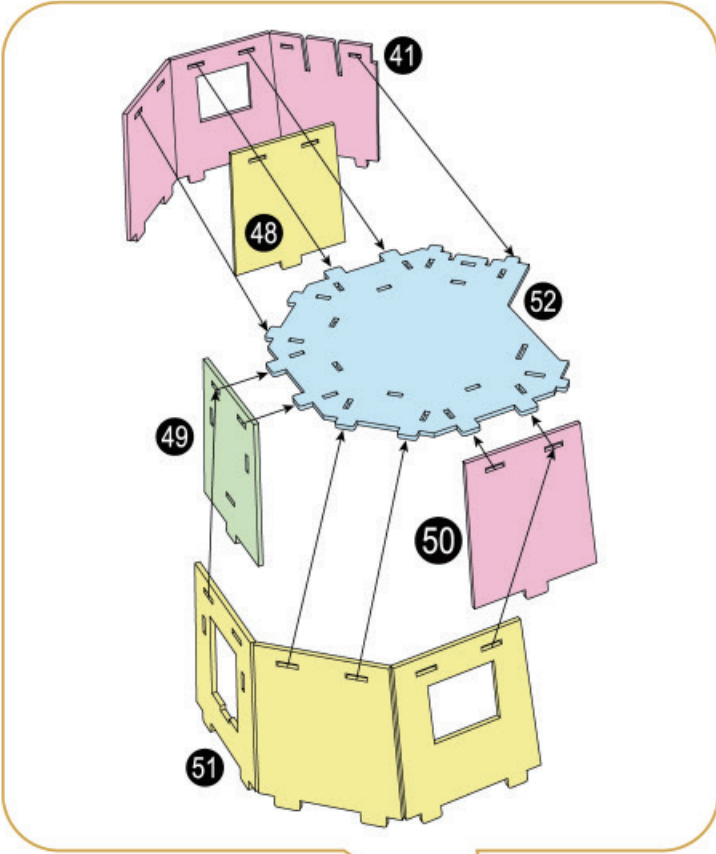

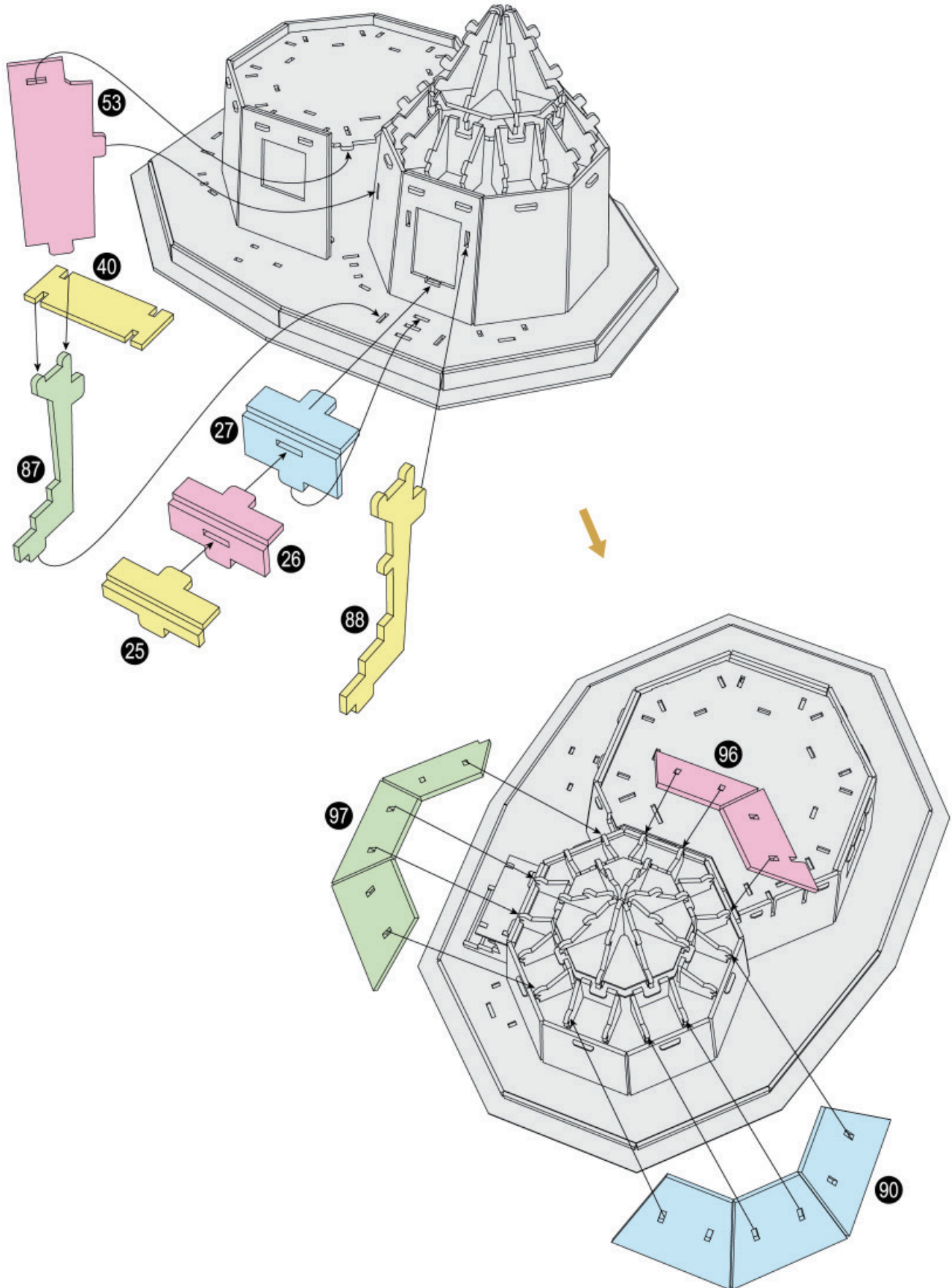

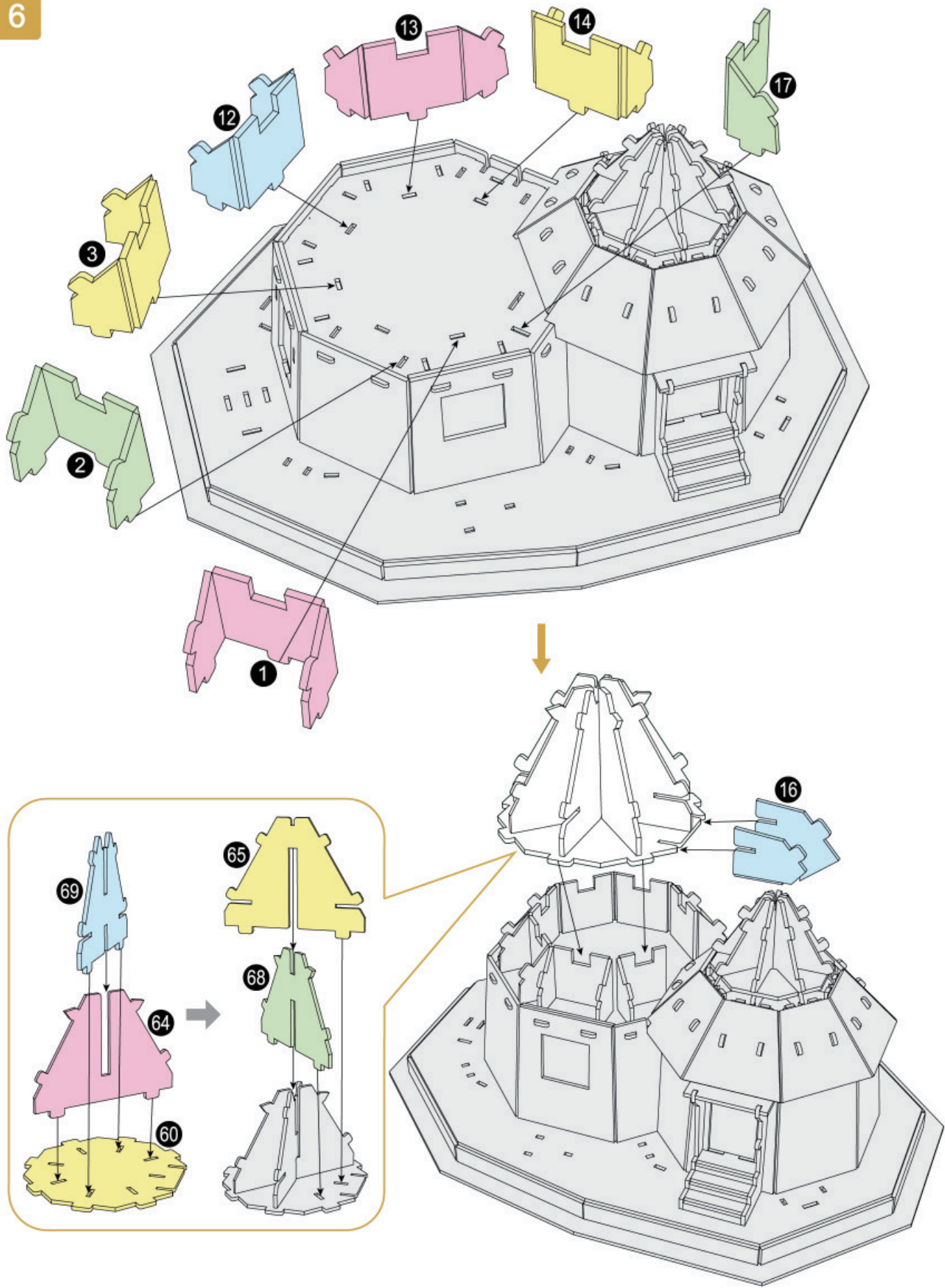

7

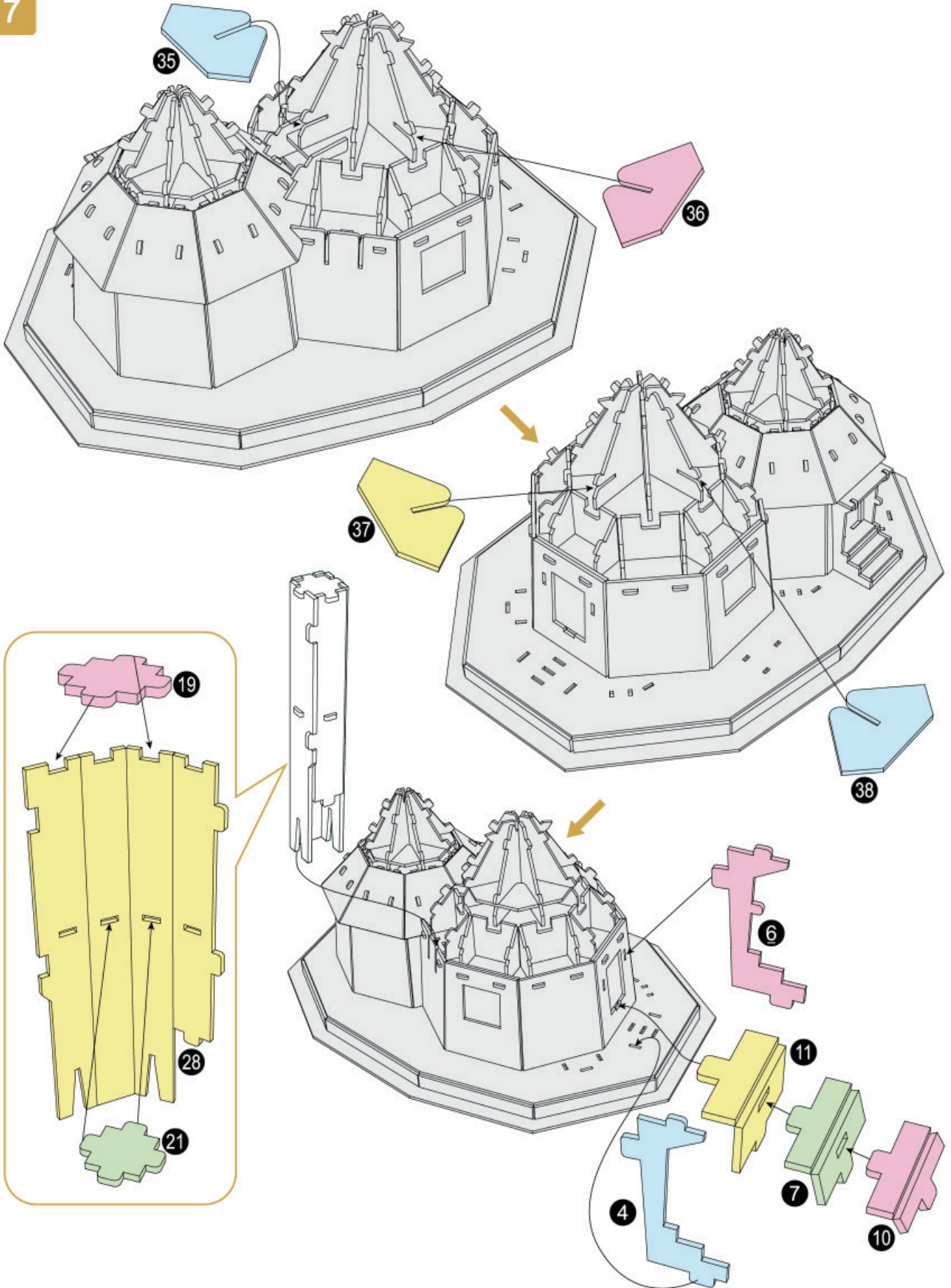

8

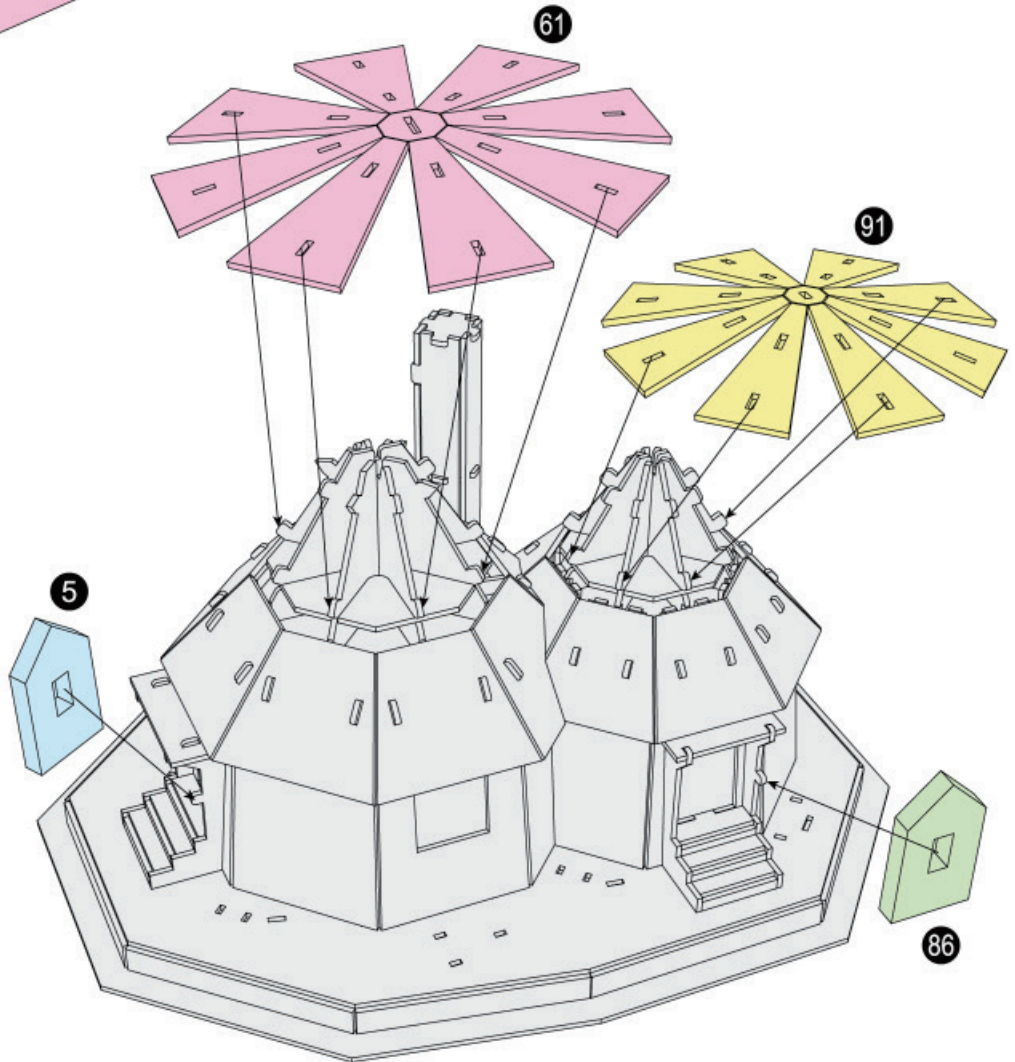
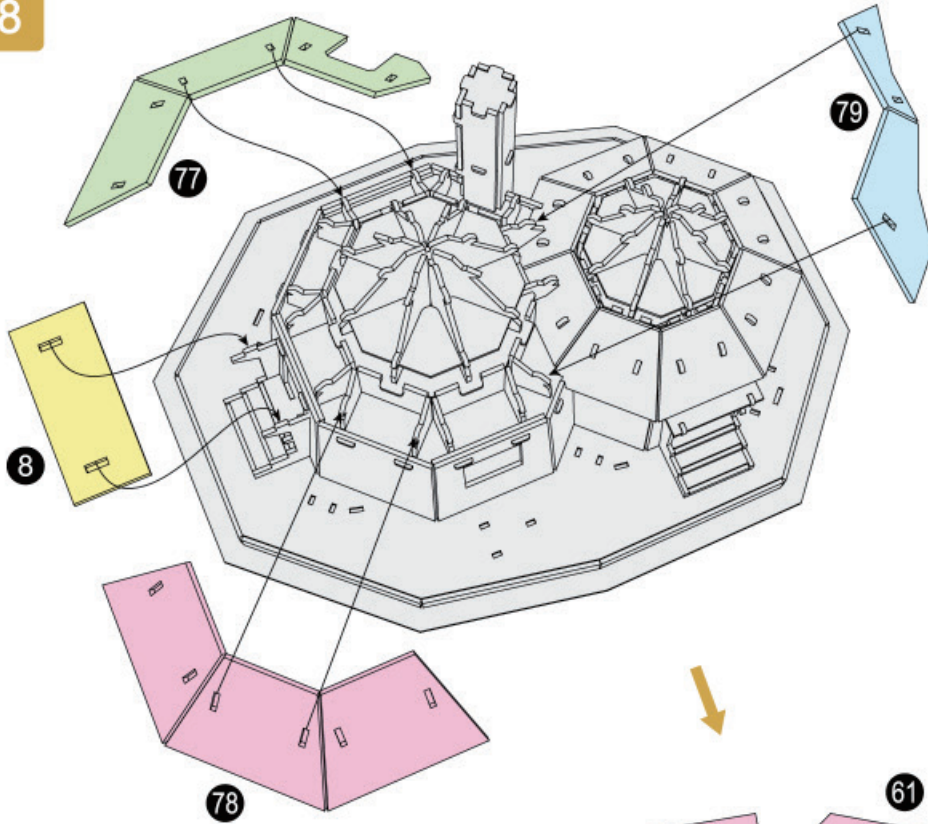

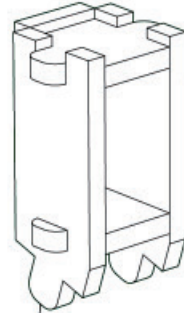
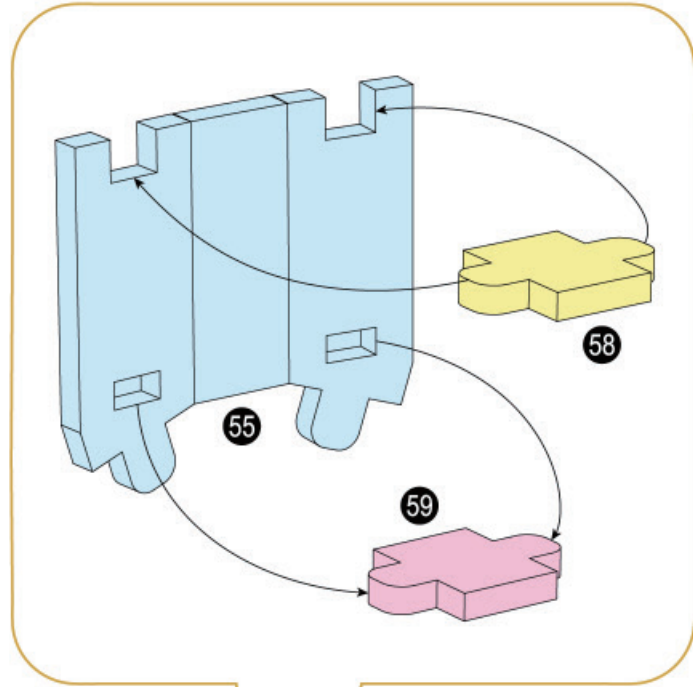
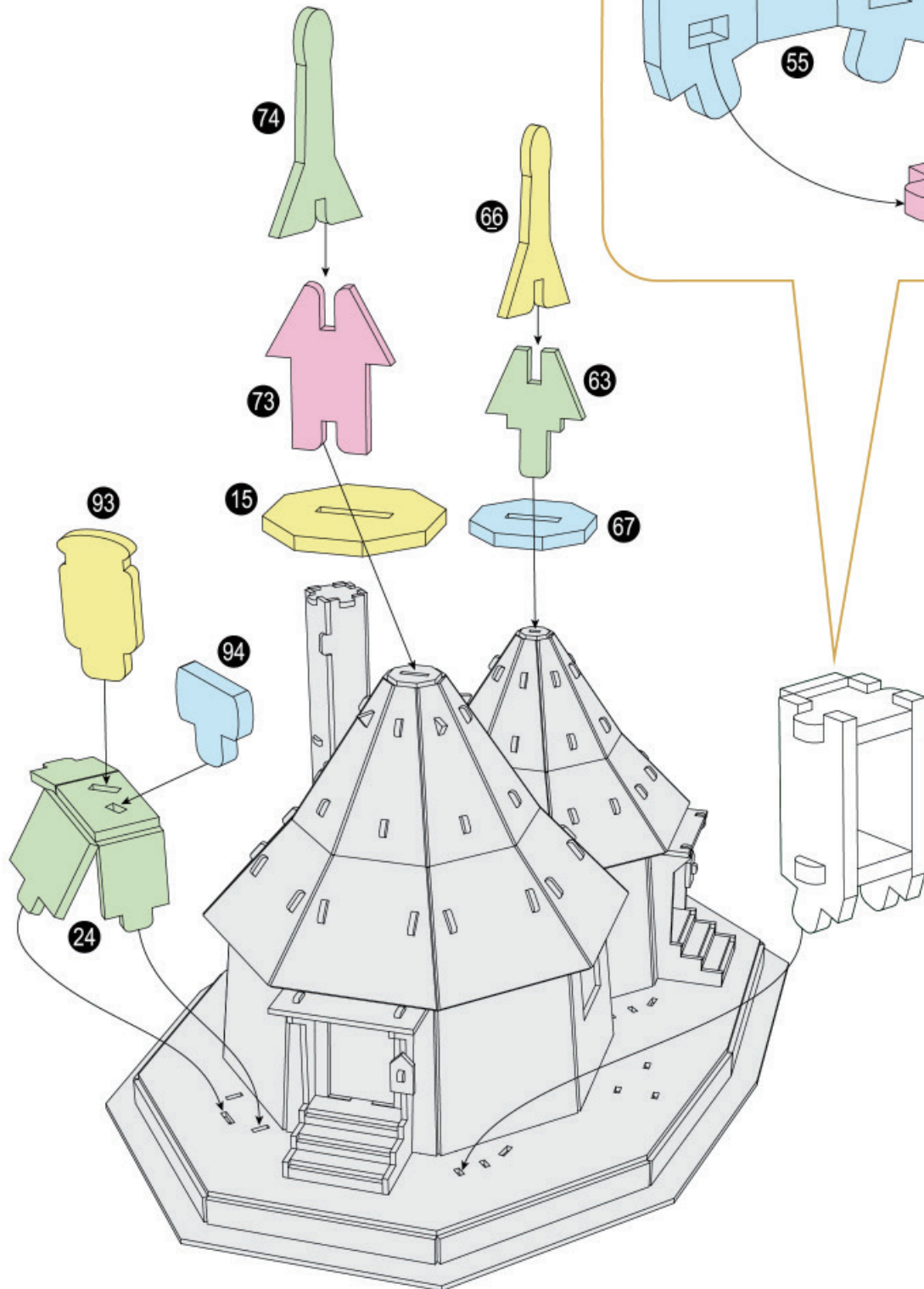

10

