



CLOAKROOM EQUIPMENT



www.clotheslockers.eu

Content

About Company	4
Modular	8
Combined clothes lockers.....	12
Laminated clothes lockers	20
Steel clothes lockers	26
Golf lockers	34
Saddle lockers	38
Ball lockers	40
Hockey boxes and multipurpose boxes	42
Ski and snowboard lockers	48
Fire lockers and lockers for rescue services	52
Key lockers	60
Cloakroom benches	62
Laminated cloakroom benches	64
Design self-watering flowerpot	65
Shelf racks	66
Workbenches	68
Container	70
Additional steel production and cooperation	71
Multifunctional storage wall	74
Mail box	76
Sanitizer stand with drip tray	77
Hygiene Stand	78
Accessories	80
Locks.....	82
Offer of decors	90
References	96
Marketing – Exhibitions	104
Presentation	106
Packaging, transportation	107
Project realization	108
Certificates	109
Notes	110



About us

Tritón Pardubice, spol. s r. o. with almost 30 years of tradition, is one of the world's leading manufacturers of 19" information, telecommunications and power cabinets, and accessories for them.

The production and development center with a total production area of 17,000 m² and more than 190 employees and specialists is located in Starý Mateřov, 5 km from Pardubice. Here, production is constantly modernized. In January 2022, the fifth production shop was completed and put into operation, including a new control room and carpentry shop with added process equipment.

Tritón Pardubice, spol. s r. o. also develops and manufactures products used to equip dressing rooms, workshops and offices. For example, lockers, boxes, hanging walls, hockey boxes, workshop furniture, or special cabinets for firefighters or sports equipment (balls, skis, snowboards, bridles, golf). We have recently added a new laminated cloakroom benches in our product portfolio. All products are available in new decor lines, in line with the latest design trends.



On January 2022, a new production hall with a usable area of nearly 3,000 m² was approved.



Automated bending center RAS



Automated bending center TRUMPF



Automated bending center RAS



Automated punch machine TRUMPF



Center for glass gluing and cabinet door seal applications for switchboards



Cross-cut saw KP 500 Automat



Nesting machining center



Dowel insertion machine



Edge bander Tempora F800



Automated milling center with feeder

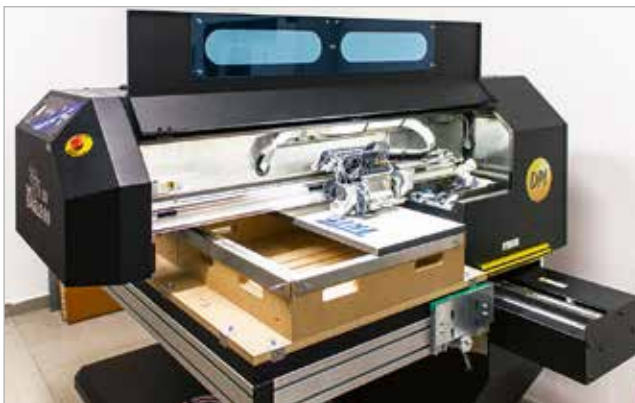

UV LED printer



Pallet stacking machine



Modular

Triton Modular clothes lockers introduce a brand new and variable concept. The body is made of steel and can be adjusted to the customers' needs; whether they need a 2-door locker, 4-box, 6-box, 8-box, or other combinations.

Doors can be made of steel or laminated chipboard and can be oriented as left, right, or left/right. Quality Hettich hinges are used to attach them to the frame.

Doors are ready for cylindrical locks or turning locks BURG as standard. Shelves have integrated holders for clothes rods.

Sizes are 1970 x 600 x 500 mm, or 1970 x 800 x 500 mm (h x w x d).

All lockers are made of high quality steel and are delivered assembled.



High quality Hettich hinges



Detail of a shelf with a chrome clothing rod



Levelling feet

The Modular Triton lockers can be adapted to the most commonly requested variants - all while using a uniform cabinet body. The body and dividing walls have perforations suitable for the placement of doors, shelves, and locks. This variability allows for additional customization of the cabinets by customers, for example, if it is necessary to increase the capacity of the wardrobe but structural modifications cannot be made. The steel parts are treated with a powder coating. The doors, made of 18mm laminated chipboard, have a 2mm thick ABS edge, ensuring a long lifespan of the material.



COLOR					
	steel grey (RAL 7035)	steel blue (RAL 5005)	steel black (RAL 9005)		
	EGGER		Kronospan STANDARD		
	Maple Mandal	Birch 1715 BS	Nagano Oak 8431 SN	Cherry 0344 BS	Walnut 0729 BS
Kronospan CONTEMPO					
	Concrete Flow K350 RT	Light Rockford Hickory K085 PW	Blonde Surfside Ash K525 SN	Gold Baroque Oak K535 RW	Amber Baroque Oak K536 RW

An extended range of decors can be found on page 90.



2-door		
Height x width x depth (mm)	1970 x 600 x 500	1970 x 800 x 500
Number of sections	2	2
Equipment	2 x shelf, 2 x rod	2 x shelf, 2 x rod
Weight net / gross (kg)	60 / 64	70 / 75
Order code	IVD-20-X65-XXX-X1	IVD-20-X85-XXX-X1



4-box		
Height x width x depth (mm)	1970 x 600 x 500	1970 x 800 x 500
Number of sections	4	4
Equipment	4 x rod	4 x rod
Weight net / gross (kg)	59 / 63	69 / 74
Order code	IVC-20-X65-XXX-X1	IVC-20-X85-XXX-X1

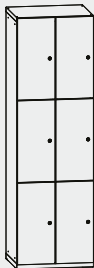

6-box		
Height x width x depth (mm)	1970 x 600 x 500	1970 x 800 x 500
Number of sections	6	6
Weight net / gross (kg)	60 / 65	71 / 76
Order code	IVE-20-X65-XXX-X1	IVE-20-X85-XXX-X1

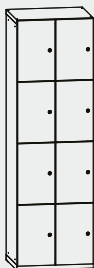

8-box		
Height x width x depth (mm)	1970 x 600 x 500	1970 x 800 x 500
Number of sections	8	8
Weight net / gross (kg)	63 / 68	74 / 79
Order code	IVF-20-X65-XXX-X1	IVF-20-X85-XXX-X1



Neubau Klinikum Fulda



AS Fitness Nový Jičín



I'M FIT Liberec



Combined clothes lockers

Steel and laminated chipboard combination

Combined clothes lockers are made of high-quality steel sheet, surface-treated with powder coating in combination with laminated chipboard in optional wood or colour decors.

All edges are equipped with a 2mm ABS edge. Lockers have pre-drilled holes for possible addition of shelves.

Perforations on the steel construction ensures efficient ventilation.

Lockers can be screwed together to create a compact, stable unit.

The combination of steel and laminated chipboard offers high quality and reliable equipment for various facilities such as companies, schools, sports facilities, hospitals, fitness centres, and more.

The basic range of colours for the steel frame consists of RAL 7035 (light grey) and RAL 9005 (black).

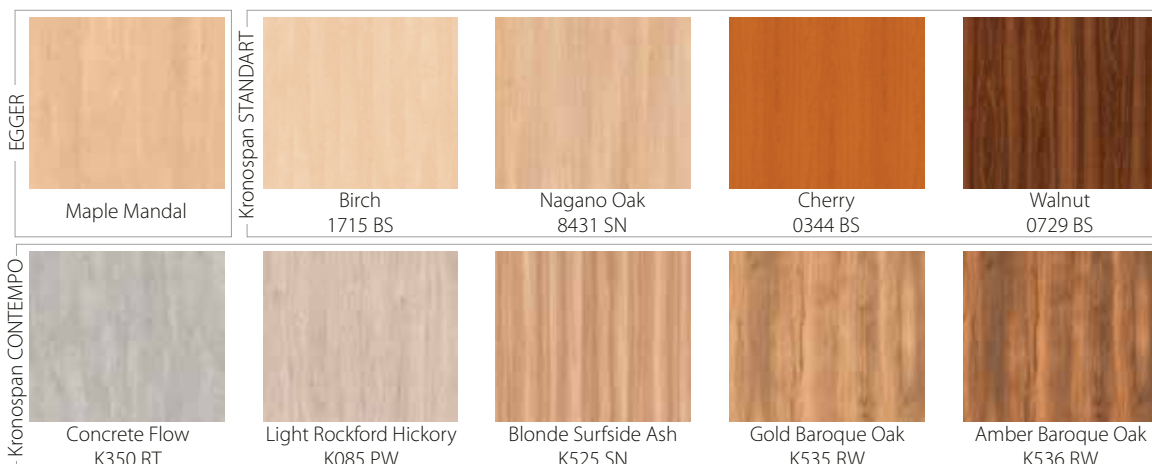

An extended range of decors can be found on page 90.



Solid frame construction



Ventilation system



Chrome bar



Unique hinges
(180° door opening)



Practical shelves



Levelling feet



1-door			
Height x width x depth (mm)	1525 x 420 x 500	1750 x 420 x 500	1970 x 420 x 500
Number of sections	1	1	1
Equipment	1 x shelf, 1 x rod	1 x shelf, 1 x rod	2 x shelf, 1 x rod
Weight net / gross (kg)	31 / 38	35 / 42	39 / 45
Order code	ISS-15-B45-XXX-X2	ISS-18-B45-XXX-X2	ISS-20-B45-XXX-X2



1-door with a seat		
Height x width x depth (mm)	1970 x 420 x 780	2195 x 420 x 780
Number of sections	1	1
Equipment	1 x shelf, 1 x rod	1 x shelf, 1 x rod
Weight net / gross (kg)	39 / 47	43 / 51
Order code	ISS-20-B48-XXX-A2	ISS-22-B48-XXX-A2



2-door			
Height x width x depth (mm)	1525 x 600 x 500	1750 x 600 x 500	1970 x 600 x 500
Number of sections	2	2	2
Equipment	2 x shelf, 2 x rod	2 x shelf, 2 x rod	4 x shelf, 2 x rod
Weight net / gross (kg)	48 / 54	54 / 60	62 / 69
Order code	ISD-15-B65-XXX-X2	ISD-18-B65-XXX-X2	ISD-20-B65-XXX-X2

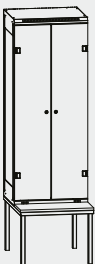

2-door with a seat		
Height x width x depth (mm)	1970 x 600 x 780	2195 x 600 x 780
Number of sections	2	2
Equipment	2 x shelf, 2 x rod	2 x shelf, 2 x rod
Weight net / gross (kg)	57 / 65	63 / 71
Order code	ISD-20-B68-XXX-A2	ISD-22-B68-XXX-A2

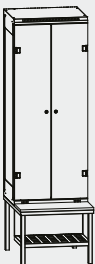

2-door with a seat with integrated grate		
Height x width x depth (mm)	1970 x 600 x 780	2195 x 600 x 780
Number of sections	2	2
Equipment	2 x shelf, 2 x rod	2 x shelf, 2 x rod
Weight net / gross (kg)	61 / 69	67 / 75
Order code	ISD-20-B68-XXX-R2	ISD-22-B68-XXX-R2

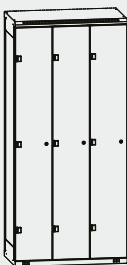

3-door		
Height x width x depth (mm)	1750 x 900 x 500	1970 x 900 x 500
Number of sections	3	3
Equipment	3 x shelf, 3 x rod	6 x shelf, 3 x rod
Weight net / gross (kg)	74 / 80	86 / 91
Order code	IST-18-B95-XXX-X2	IST-20-B95-XXX-X2



3-door locker, grey RAL 7035/
maple Mandal laminate



2-door locker,
grey RAL 7035/ Amber Baroque Oak laminate



2-door locker,
grey RAL 7035/maple Mandal laminate



2-door locker with a bench,
grey RAL 7035/pine laminate



2-door locker with a bench,
grey RAL 7035/cherry Locarno laminate

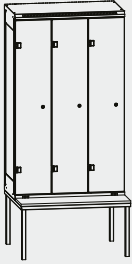

3-door with a seat		
Height x width x depth (mm)	1970 x 900 x 780	2195 x 900 x 780
Number of sections	3	3
Equipment	3 x shelf, 3 x rod	3 x shelf, 3 x rod
Weight net / gross (kg)	77 / 85	85 / 90
Order code	IST-20-B98-XXX-A2	IST-22-B98-XXX-A2

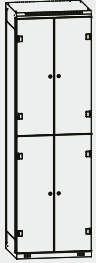

4-box			
Height x width x depth (mm)	1525 x 600 x 500	1750 x 600 x 500	1970 x 600 x 500
Number of sections	4	4	4
Equipment	4 x rod	4 x rod	4 x rod
Weight net / gross (kg)	49 / 57	54 / 60	59 / 66
Order code	ISC-15-B65-XXX-X2	ISC-18-B65-XXX-X2	ISC-20-B65-XXX-X2

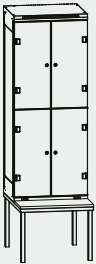

4-box with a seat		
Height x width x depth (mm)	1970 x 600 x 780	2195 x 600 x 780
Number of sections	4	4
Equipment	4 x rod	4 x rod
Weight net / gross (kg)	58 / 66	67 / 75
Order code	ISC-20-B68-XXX-A2	ISC-22-B68-XXX-A2

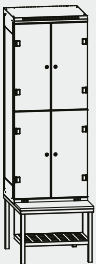

4-box with a seat with integrated grate		
Height x width x depth (mm)	1970 x 600 x 780	2195 x 600 x 780
Number of sections	4	4
Equipment	4 x rod	4 x rod
Weight net / gross (kg)	62 / 70	71 / 79
Order code	ISC-20-B68-XXX-R2	ISC-22-B68-XXX-R2

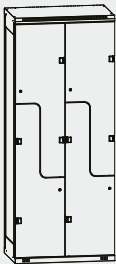

„Z“-type	
Height x width x depth (mm)	1970 x 800 x 500
Number of sections	4
Equipment	4 x rod
Weight net / gross (kg)	69 / 77
Order code	ISZ-20-B85-XXX-X2

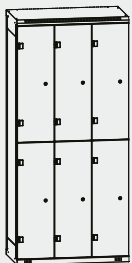

6-box	
Height x width x depth (mm)	1970 x 900 x 500
Number of sections	6
Equipment	6 x rod
Weight net / gross (kg)	78 / 88
Order code	ISE-20-B95-XXX-X2

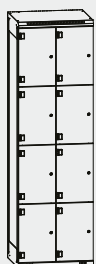

8-box	
Height x width x depth (mm)	1970 x 600 x 500
Number of sections	8
Equipment	-
Weight net / gross (kg)	59 / 66
Order code	ISF-20-B65-XXX-X2



4-box locker,
grey RAL 7035/maple Mandal
laminat



4-box locker,
grey RAL 7035/oak Bardolino laminat



4-box locker with a bench,
black RAL 9005/oak Corbridge laminat



4-box „Z“ locker,
grey RAL 7035/maple Mandal laminat



6-box locker,
black RAL 9005/oak Bardolino laminat



8-box locker,
grey RAL 7035/maple Mandal laminat



Amusement park Krokodýlek, Olomouc



Nordic Lockers



3D Yoga Pardubice



Sauna paradise Holic



Hardcore Gym Aarau



Golf resort Malacky Eurovalley Golf Park



Elementary school Schulzovy sady



Fitness Sokolov



Laminated clothes lockers











Laminated clothes lockers are made from laminated chipboard with a thickness of 18mm in timeless decors. Simple and elegant design is complemented by cylindrical lock with two keys or any other locking solution. All edges are finished with 2mm ABS.

Stainless steel perforated grille allows circulation of the air together with offset doors.

Unique Hettich hinges ensure silent closing of the doors.

This locker will become an elegant part of your interior.



EGGER		Kronospan STANDART			
	Maple Mandal				
Kronospan CONTEMPO					
	Concrete Flow K350 RT	Light Rockford Hickory K085 PW	Blonde Surfside Ash K525 SN	Gold Baroque Oak K535 RW	Amber Baroque Oak K536 RW

An extended range of decors can be found on page 90.



2-door locker, maple Mandal



4-box locker with a bench, light Rockford Hickory



Chrome bar



Practical shelves



Ventilation system



Storage space



1-door	
Height x width x depth (mm)	1970 x 420 x 500
Number of sections	1
Equipment	2 x shelf, 1 x rod
Weight net / gross (kg)	39 / 45
Order code	ILS-20-B45-XXX-XN



2-door	
Height x width x depth (mm)	1970 x 600 x 500
Number of sections	2
Equipment	4 x shelf, 2 x rod
Weight net / gross (kg)	62 / 69
Order code	ILD-20-B65-XXX-XN



2-door with a seat	
Height x width x depth (mm)	1970 x 600 x 780
Number of sections	2
Equipment	2 x shelf, 2 x rod
Weight net / gross (kg)	57 / 65
Order code	ILD-20-B65-XXX-AN

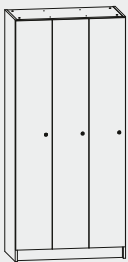

3-door	
Height x width x depth (mm)	1970 x 900 x 500
Number of sections	3
Equipment	6 x shelf, 3 x rod
Weight net / gross (kg)	86 / 91
Order code	ILT-20-B95-XXX-XN

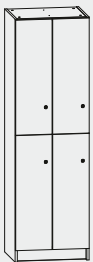

4-box	
Height x width x depth (mm)	1970 x 600 x 500
Number of sections	4
Equipment	4 x shelf, 4 x rod
Weight net / gross (kg)	59 / 66
Order code	ILC-20-B65-XXX-XN

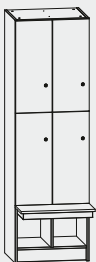

4-box with a seat	
Height x width x depth (mm)	1970 x 600 x 780
Number of sections	4
Equipment	4 x rod
Weight net / gross (kg)	58 / 66
Order code	ILC-20-B68-XXX-AN

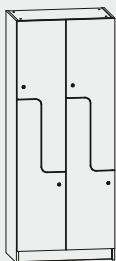

„Z“ box	
Height x width x depth (mm)	1970 x 800 x 500
Number of sections	4
Equipment	4 x rod
Weight net / gross (kg)	69 / 77
Order code	ILZ-20-B85-XXX-XN



6-box	
Height x width x depth (mm)	1970 x 900 x 500
Number of sections	6
Equipment	6 x shelf, 6 x rod
Weight net / gross (kg)	78 / 88
Order code	ILE-20-B95-XXX-XN



8-box	
Height x width x depth (mm)	1970 x 600 x 500
Number of sections	8
Equipment	-
Weight net / gross (kg)	59 / 66
Order code	ILF-20-B65-XXX-XN



10-box	
Height x width x depth (mm)	1970 x 800 x 500
Number of sections	8
Equipment	-
Weight net / gross (kg)	59 / 66
Order code	ILG-20-B85-XXX-XN





Chrome wardrobe rod of the upper box



Chrome wardrobe rod of the lower box



Hettich furniture hinges

4-box „Z“ - checkerboard doors



The Courtyard



Hotel SEN



Zoom Cycle Praha



Jungle sport park



Steel clothes lockers

Metal clothes lockers are made of high-quality steel sheet with a powder-coated finish. The powder coating technology fully meets the requirements of our clients, as it provides high resistance to chemical and mechanical damage.

The rigid frame construction ensures the strength and stability of each locker. Reinforced doors can be opened at an angle of almost 180° thanks to the unique hinge system. Perforations in the doors and steel structure ensure sufficient ventilation. Leveling feet are included with each delivery.

Lockers can be screwed together to form a single compact and stable unit. A typical feature of Triton lockers is their timeless design and high quality workmanship. They are suitable mainly for locker rooms in various facilities such as companies, schools, sports facilities, hospitals, etc.

The basic colour range consists of shades of RAL 7035 (light grey), RAL 5005 (blue), and RAL 9005 (black). Other colour options are available upon individual request based on the RAL colour chart.



4-box
grey RAL 7035/blue RAL 5005



4-box „Z“ with roof
grey RAL 7035/blue RAL 5005

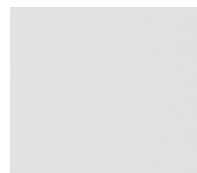

steel grey
(RAL 7035)



steel blue
(RAL 5005)

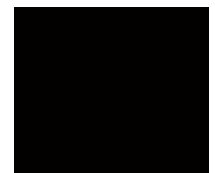

steel black
(RAL 9005)



Solid frame construction



Ventilation system



Solid section divider



Reinforced door frame, unique hinges



Practical shelves



Levelling feet



1-door			
Height x width x depth (mm)	1525 x 420 x 500	1750 x 420 x 500	1970 x 420 x 500
Number of sections	1	1	1
Equipment	1 x shelf, 1 x rod	1 x shelf, 1 x rod	2 x shelf, 1 x rod
Weight net / gross (kg)	29 / 35	32 / 39	36 / 43
Order code	ISS-15-A45-XXX-X2	ISS-18-A45-XXX-X2	ISS-20-A45-XXX-X2

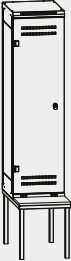

1-door with a seat		
Height x width x depth (mm)	1970 x 420 x 780	2195 x 420 x 780
Number of sections	1	1
Equipment	1 x shelf, 1 x rod	1 x shelf, 1 x rod
Weight net / gross (kg)	37 / 45	40 / 48
Order code	ISS-20-A48-XXX-A2	ISS-22-A48-XXX-A2



2-door			
Height x width x depth (mm)	1525 x 600 x 500	1750 x 600 x 500	1970 x 600 x 500
Number of sections	2	2	2
Equipment	2 x shelf, 2 x rod	2 x shelf, 2 x rod	4 x shelf, 2 x rod
Weight net / gross (kg)	44 / 51	50 / 57	57 / 63
Order code	ISD-15-A65-XXX-X2	ISD-18-A65-XXX-X2	ISD-20-A65-XXX-X2



2-door with a seat		
Height x width x depth (mm)	1970 x 600 x 780	2195 x 600 x 780
Number of sections	2	2
Equipment	2 x shelf, 2 x rod	2 x shelf, 2 x rod
Weight net / gross (kg)	54 / 62	58 / 66
Order code	ISD-20-A68-XXX-A2	ISD-22-A68-XXX-A2



2-door with a seat with integrated grate		
Height x width x depth (mm)	1970 x 600 x 780	2195 x 600 x 780
Number of sections	2	2
Equipment	2 x shelf, 2 x rod	2 x shelf, 2 x rod
Weight net / gross (kg)	58 / 66	62 / 70
Order code	ISD-20-A68-XXX-R2	ISD-22-A68-XXX-R2



3-door		
Height x width x depth (mm)	1750 x 900 x 500	1970 x 900 x 500
Number of sections	3	3
Equipment	3 x shelf, 3 x rod	6 x shelf, 3 x rod
Weight net / gross (kg)	67 / 77	76 / 86
Order code	IST-18-A95-XXX-X2	IST-20-A95-XXX-X2



2-door locker, grey RAL 7035/blue RAL 5005



2-door locker with a bench, grey RAL 7035



1-door locker,
grey RAL 7035/blue RAL 5005



3-door locker,
grey RAL 7035/blue RAL 5005



3-door locker with a bench,
grey RAL 7035/black RAL 9005

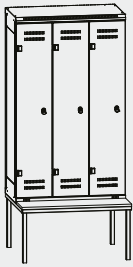

3-door with a seat		
Height x width x depth (mm)	1970 x 900 x 780	2195 x 900 x 780
Number of sections	3	3
Equipment	3 x shelf, 3 x rod	3 x shelf, 3 x rod
Weight net / gross (kg)	72 / 79	79 / 84
Order code	IST-20-A98-XXX-A2	IST-22-A98-XXX-A2



4-box			
Height x width x depth (mm)	1525 x 600 x 500	1750 x 600 x 500	1970 x 600 x 500
Number of sections	4	4	4
Equipment	4 x rod	4 x rod	4 x rod
Weight net / gross (kg)	48 / 55	52 / 58	57 / 63
Order code	ISC-15-A65-XXX-X2	ISC-18-A65-XXX-X2	ISC-20-A65-XXX-X2



4-box with a seat		
Height x width x depth (mm)	1970 x 600 x 780	2195 x 600 x 780
Number of sections	4	4
Equipment	4 x rod	4 x rod
Weight net / gross (kg)	58 / 64	61 / 69
Order code	ISC-20-A68-XXX-A2	ISC-22-A68-XXX-A2



4-box with a seat with integrated grate		
Height x width x depth (mm)	1970 x 600 x 780	2195 x 600 x 780
Number of sections	4	4
Equipment	4 x rod	4 x rod
Weight net / gross (kg)	62 / 68	65 / 73
Order code	ISC-20-A68-XXX-R2	ISC-22-A68-XXX-R2

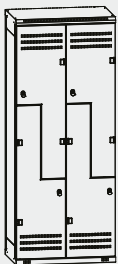

„Z“-type	
Height x width x depth (mm)	1970 x 800 x 500
Number of sections	4
Equipment	4 x rod
Weight net / gross (kg)	64 / 74
Order code	ISZ-20-A85-XXX-X2



6-boxové	
Height x width x depth (mm)	1970 x 900 x 500
Number of sections	6
Equipment	6 x rod
Weight net / gross (kg)	73 / 83
Order code	ISE-20-A95-XXX-X2



8-box	
Height x width x depth (mm)	1970 x 600 x 500
Number of sections	8
Equipment	-
Weight net / gross (kg)	54 / 61
Order code	ISF-20-A65-XXX-X2

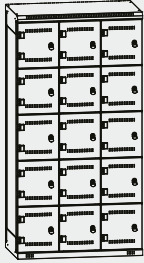

15-box	
Height x width x depth (mm)	1750 x 900 x 500
Number of sections	15
Equipment	-
Weight net / gross (kg)	94 / 104
Order code	ISO-18-A95-XXX-X2



4-box locker with a bench, grey RAL 7035/blue RAL 5005



15-box locker, grey RAL 7035/grey RAL 7035 and blue RAL 5005



Tritón Pardubice, spol. s r.o.



Tritón Pardubice, spol. s r.o.



Elementary School Pardubice – Polabiny, Npor. Eliáše



Agrarlandtechnik



Euro Bus



Neu Mitte Schule



AZ Herentals



Internationale Schule Hamburg



Vodovody a kanalizace Přebouč



Hotel Melia Wien



Dostihový spolek Pardubice



Elementary School and Kindergarten Chotíkov



APAG Elektronik s.r.o.



Golf lockers

Golf lockers are used for safe storage of golf carts, bags and other golf equipment.

Lockers are made of high quality zinc-coated steel with powder-coated finish. This combination ensures resistance to chemical or mechanical damage.

A shelf for storing a control panel or cart charger is located on the side of the locker.

A hole in the back allows easy cable access inside the locker.

Users will appreciate the conveniently located basket for golf balls and other small items on the inside of the reinforced doors.

Perforations in the doors and front of the body ensure air circulation. The safety of stored items is ensured by high-quality locks.

Triton golf lockers are designed to be used in two floors stacked on top of each other.



Shelf for power distribution unit



Opening for electric installation

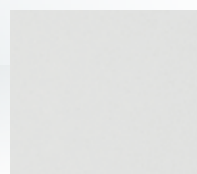

steel grey
(RAL 7035)



steel blue
(RAL 5005)



steel black
(RAL 9005)



Golf lockers – steel

Height x width x depth (mm)	1250 x 550 x 550	1250 x 825 x 550	1250 x 825 x 1100
Equipment	basket for golf balls and small items, shelf for a power distribution unit		
Weight net / gross (kg)	36 / 43	44 / 50	62 / 69
Order code	IGS-13-A55-XXX-XX	IGS-13-A85-XXX-XX	IGS-13-A80-XXX-XX

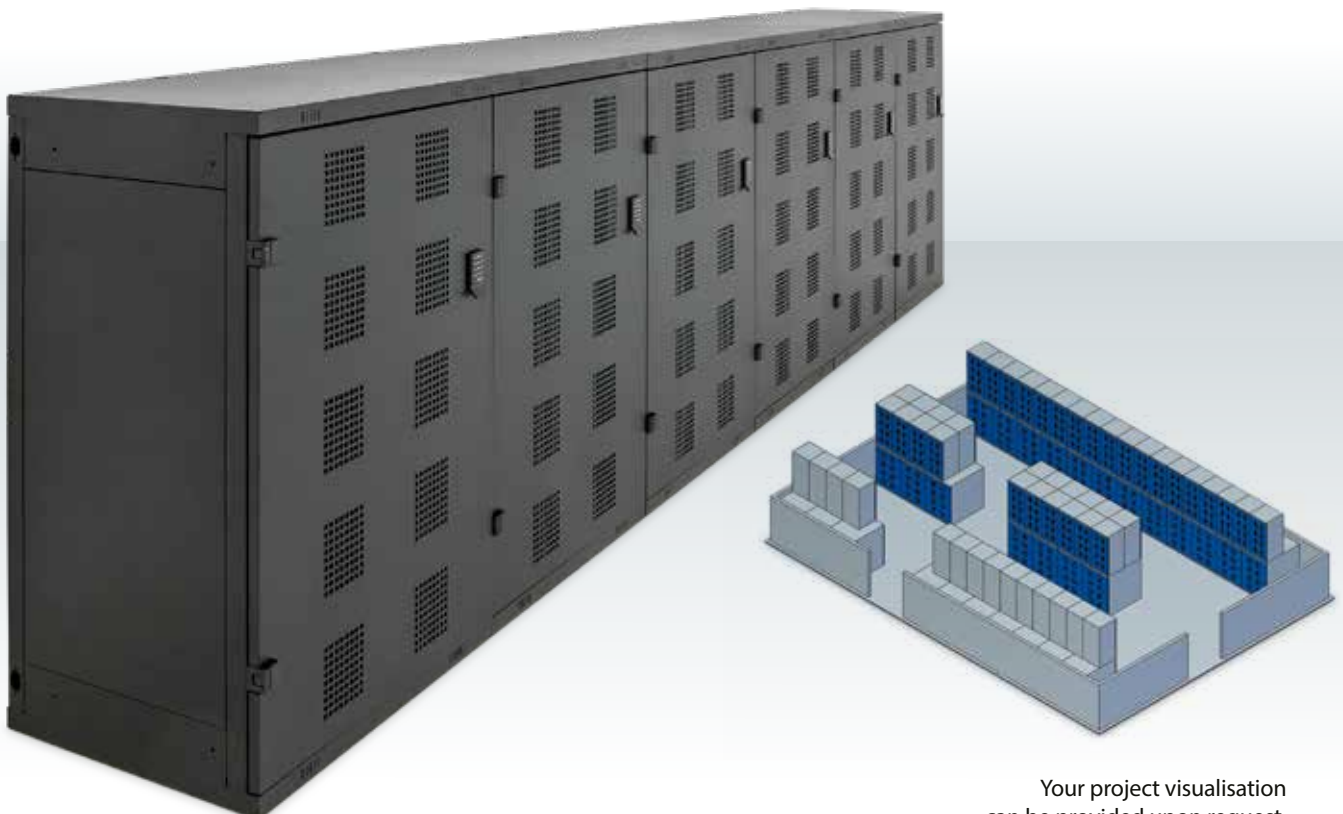

Your project visualisation can be provided upon request.



Migros Golfplatz Moossee



Golf Club Pardubice - Lázně Bohdaneč



Golf Club Pyšely



Golf resort Buchholz



City & Country Golfclub Am Wienerberg



Les Bois



Golfplatz Clebronn



Golf Club Bad Rappenau



Golf-Club Peine-Edemissen e.V.



Golf Mstětice



Golf Club Gams Werdenberg





Saddle locker

Saddle lockers are designed to store saddles and other equestrian equipment. Lockers are made of high quality zinc-coated steel with powder-coated finish. This combination ensures resistance to chemical or mechanical damage. Lockers can be screwed together to create one compact unit.

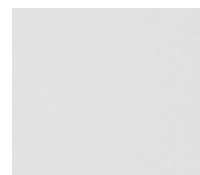

steel grey
(RAL 7035)



steel blue
(RAL 5005)

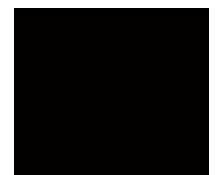

steel black
(RAL 9005)

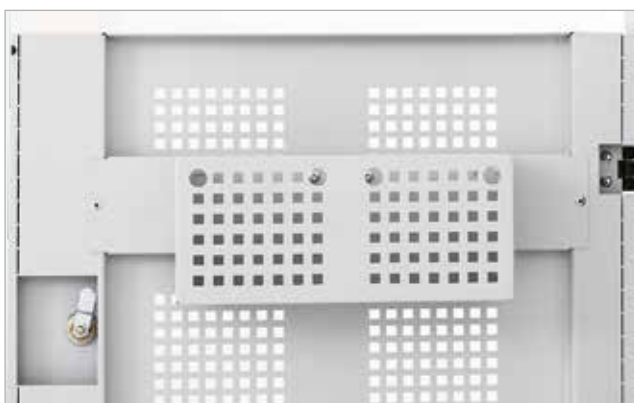

Basket for small items



Saddle holder, bridle hanger



Saddle locker

Height x width x depth (mm)	1100 x 600 x 600
Number of sections	1
Equipment	2 x saddle holder including a hook for a bridle, 2 x steel hanger for bridles, basket for small items
Weight net / gross (kg)	42 / 47
Order code	KSS-11-A66-XXX-X1



Saddle holder including a hook for a bridle











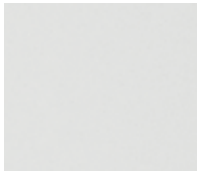

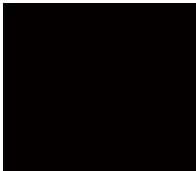

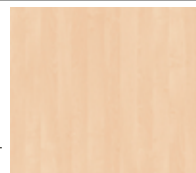
Ball lockers

Ball lockers are used for storing all kinds of balls, for example in gymnasiums and sports facilities.

The metal ball lockers are equipped with four height-adjustable shelves that have a raised bend and a backward slope to prevent the balls from falling out of the locker.

The ball lockers made of 18 mm laminated chipboard have one fixed shelf and two adjustable shelves for greater versatility. Additional shelves can be supplied separately if needed. All edges are finished with a 2 mm ABS edge.

	COLOR						
							
	steel grey (RAL 7035)	steel blue (RAL 5005)	steel black (RAL 9005)				
EGGER	Kronospan STANDART						
		Maple Mandal	Birch 1715 BS	Nagano Oak 8431 SN	Cherry 0344 BS	Walnut 0729 BS	
		Kronospan CONTEMPO					
			Concrete Flow K350 RT	Light Rockford Hickory K085 PW	Blonde Surfside Ash K525 SN	Gold Baroque Oak K535 RW	Amber Baroque Oak K536 RW

An extended range of decors can be found on page 90.



Ball lockers	steel	laminite
Height x width x depth (mm)	1970 x 900 x 400	2100 x 1200 x 600
Number of sections	1	1
Equipment	4 height-adjustable shelves, jersey rod	solid shelf, 2 adjustable shelves, turning lock Burg
Weight net / gross (kg)	70 / 75	135 / 143
Order code	IMS-20-A94-XXX-X1	YYAT18-0002-16





Hockey boxes and multipurpose boxes

A hockey box is made of laminated chipboard and is ideal for use in winter stadium locker rooms. It can also be used in other sports facilities where closed lockers are not needed.

The hockey box is available in two basic variants - with an open or closed space under the bench. It includes one lockable compartment with a personal item slot, two double hooks, and two storage shelves.

The locker is intended for one to two persons.

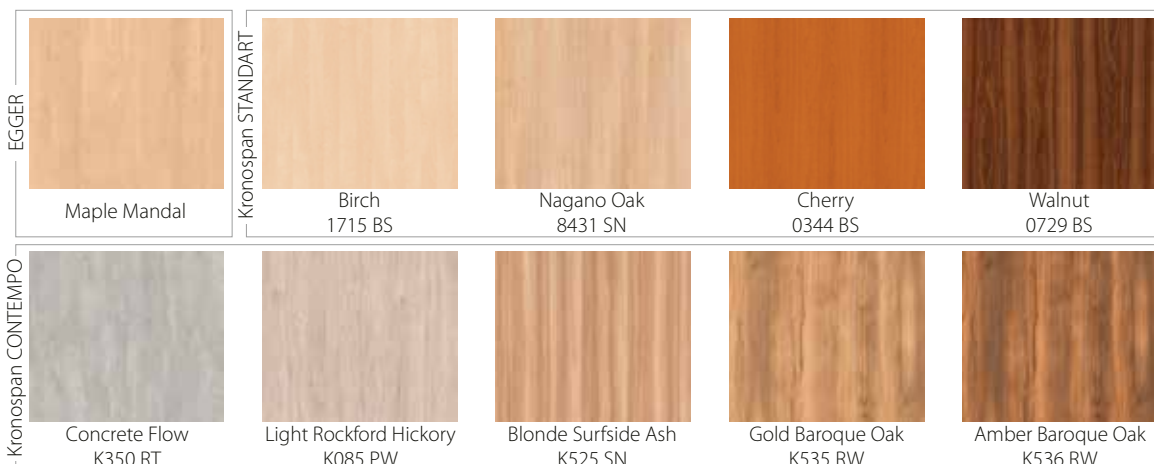

An extended range of decors can be found on page 90.



Hockey boxes and multipurpose boxes

Height x width x depth (mm)	1970 x 600 x 600	1970 x 600 x 600	1970 x 800 x 600	1970 x 800 x 600
Number of sections	1	1	1	1
Equipment	2x shelf, 1x box, 2x double hooks, open space under the bank (seat)	2x shelf, 1x box, 2x double hooks	2x shelf, 1x box, 2x double hooks, open space under the bank (seat)	2x shelf, 1x box, 2x double hooks
Weight net / gross (kg)	54 / 63	56 / 66	63 / 68	67 / 74
Order code	IAH-20-B66-XXX-X0	IAH-20-B66-XXX-X1	IAH-20-B86-XXX-X0	IAH-20-B86-XXX-X1



The HPL universal box is made of high-pressure laminate, which is extremely durable and ideal for dressing rooms in all professional and semi-professional clubs.

There are two versions designed: a player version with a width of 800 mm and a goalkeeper version with a width of 1000 mm.

As this is an exclusive matter, we offer a wide range of decors to meet the requirements of all clubs for their colour combinations.



HPL hockey box

Height x width x depth (mm)	2180 x 800 x 650	2180 x 1000 x 650
Equipment	2x shelf, 3x hooks, storage space under the seat	2x shelf, 3x hooks, storage space under the seat
Weight net / gross (kg)	90 / 96	107 / 113
Order code	NPAT18-0002-11 hockey player	NPAT18-0002-01 hockey goalkeeper







Fredericia Idrætscenter



HC Warnsdorf



HC Dynamo Pardubice



HC AZ Havířov



HC Dynamo Pardubice

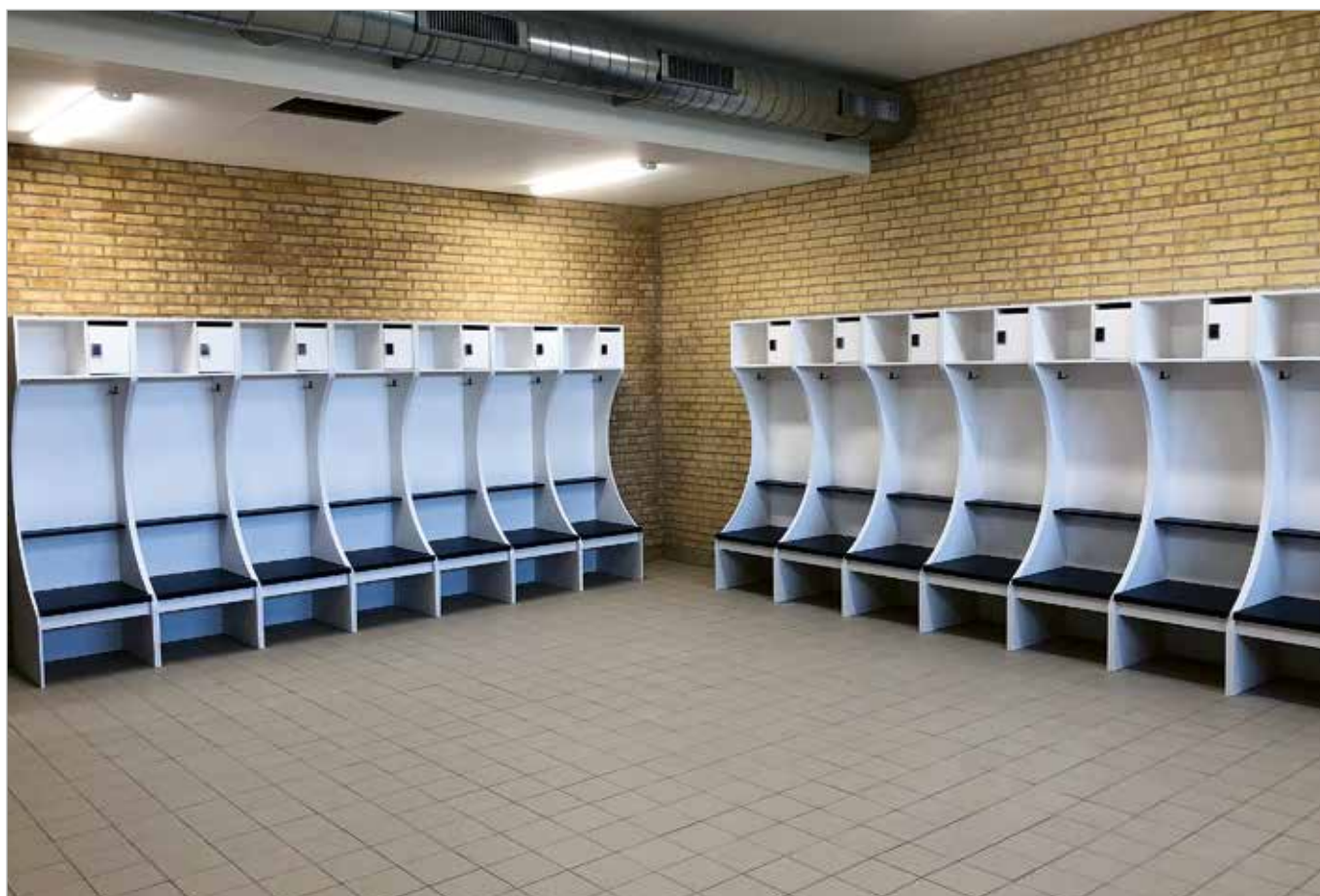

Vendsyssel FF



Vendsyssel FF



Vendsyssel FF



HC Poděbrady



Umeå FC



Ski and snowboard lockers

Ski and snowboard lockers are designed to equip ski resorts, hotels, guesthouses, and ski depots.

These lockers are characterized by a sturdy welded structure made of galvanized steel sheet, coated with a durable powder coating.

The rear cover is predesigned for an effective drying system for boots.

Special perforations in the doors and back ensure air circulation inside the locker.

The version with 2/3 shelves allows for the full height of the locker to be used for storing long items.

The lockers can be equipped with a galvanized slope tray or a grid.

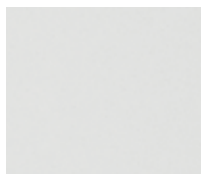

steel grey
(RAL 7035)



steel blue
(RAL 5005)



steel black
(RAL 9005)

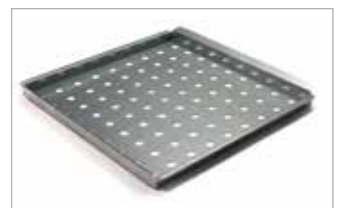

NLAT20-0005-66 – removable drip tray, sloped SKI 320x600

NLAT20-0005-67 – removable drip tray, sloped SKI 520x600

NLAT20-0005-68 – removable grid SKI 320x600

NLAT20-0005-69 – removable grid SKI 520x600



Ski and snowboard lockers

Height x width x depth (mm)	2155 x 320 x 600	2155 x 520 x 600
Number of sections	1	1
Equipment	1 x shelf	1 x shelf
Weight net / gross (kg)	44 / 49	54 / 58
Order code	LSS-21-A36-XXX-X2 - zinc-coated	LSS-21-A56-XXX-X2 - zinc-coated
Order code 2/3 shelf	LSS-21-A36-XXX-X3 - zinc-coated	LSS-21-A56-XXX-X3 - zinc-coated

Drying systems

The drying systems for shoes, ski boots, and rubber boots work on the principle of continuous circulation of warm air, which is blown into the drying object. The warm air at around 45°C (at ambient temperatures of 15°C to 25°C) is ideal for fast, hygienic, and safe drying. The dryers are typically equipped with an analogue timing device that allows for setting the switch-off time from 1 to 120 minutes.

Drying systems have a wide range of applications in various industries, such as fire and rescue services, chemical laboratories, construction companies, industrial facilities, agricultural facilities, hotels, cottages, guesthouses, road maintenance, military, police, hockey clubs, football clubs, and others.

The dryer can be used as a shoe dryer, ski boot dryer, rubber boot dryer, or drying cabinet.





Hotel Harmony



Bergbahnen Belalp Blatten



Deep Pec pod Sněžkou



Hause Chappelle in Ulrichen



Hotel Svatý Vavřinec



Orea Resort Horal



Orea Resort Horal



Orea Resort Horal



Grandhotel Hradec, Pec pod Sněžkou



Fire lockers

and lockers for rescue services

Specialized lockers designed for firefighters and rescue services. They are made of welded steel sheet with a thickness of 1mm. They ensure immediate access to intervention clothing whenever needed.

The lockers do not come with legs as standard equipment, but they can be purchased separately.

For an additional fee, the lockers can be equipped with a special foldable helmet holder. Simply pulling the helmet releases the holder, making it much easier to remove.



Tiltable helmet holder

Order code: IAI-02-XXX-IXX-T1



Feet with levelling screws

Order code: IAI-01-XXX-XXX-X1



steel red
(RAL 3000)



IPA



IPB

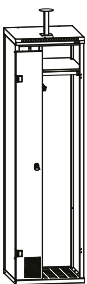

IPA	
Height x width x depth (mm)	1780 x 500 x 500
Number of sections	2
Equipment	2 x shelf, rod, helmet holder, 3 x steel clothes hooks
Weight net / gross (kg)	48 / 53
Order code	IPA-18-A55-IIR-X1 (mechanical code lock), IPA-18-A55-IIC-X1 (cylindrical lock)

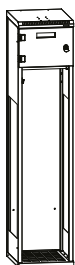

IPB	
Height x width x depth (mm)	1780 x 400 x 500
Number of sections	1
Equipment	1 x lockable box, rod, 3 x steel clothes hooks, special ventilation system between lockers (perforation in side panels)
Weight net / gross (kg)	41/46
Order code	IPB-18-A45-IIC-X2 (cylindrical lock), IPB-18-A45-IIR-X2 (mechanical code lock)



IPC



IPD

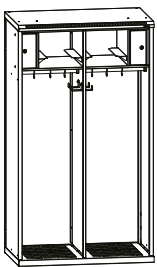

IPC	
Height x width x depth (mm)	1780 x 1000 x 600
Number of sections	2
Equipment	chrome rod with hooks, inner helmet holder, belt hooks, lockable storage boxes
Weight net / gross (kg)	71 / 78
Order code	IPC-18-A16-IIR-D2 (mechanical code lock), IPC-18-A16-IIC-D2 (cylindrical lock)

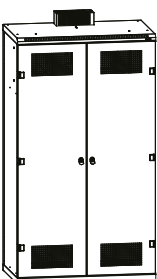

IPD	
Height x width x depth (mm)	1780 x 1000 x 600
Number of sections	2
Equipment	chrome rod with hooks, inner helmet holder, belt hooks, lockable storage boxes, dryer (energy consumption 500 W/H)
Weight net / gross (kg)	95 / 101
Order code	IPD-18-A16-IIC-D2(cylindrical lock), IPD-18-A16-IIR-D2 (mechanical code lock)



IPO



IPS

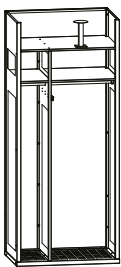

IPO	
Height x width x depth (mm)	1780 x 750 x 500
Number of sections	2
Equipment	rod, helmet holder, 3x steel clothes hooks, special perforation
Weight net / gross (kg)	49 / 55
Order code	IPO-18-X75-IIX-X1

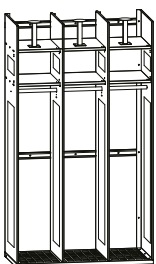

IPS		
Height x width x depth (mm)	1780 x 1000 x 500	
Number of sections	3	
Equipment	rod, 3x helmet holder, special perforation	
Weight net / gross (kg)	48 / 55	41 / 48
Order code	IPS-18-X15-IIX-ZX	IPS-18-X15-IIX-DX without one side wall

IPS lockers are made to be fixed to the wall and are delivered unassembled in packaging of apx. 180 x 350 x 550 mm.



IPE – X1

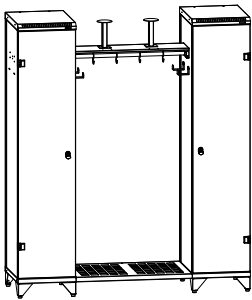

IPE (X1)	
Height x width x depth (mm)	1780 x 1600 x 500
Number of sections	2
Equipment	chrome rod with hooks, helmet holder, 2 clothes/belt hooks, galvanized steel grate in locker: chrome rod, 2 clothes hooks, 3 doublehooks, 2 shelves
Weight net / gross (kg)	100/ 106
Order code	IPE-18-A85-IIC-X1 (cylindrical lock) IPE-18-A85-IIR-X1 (mechanical code lock)

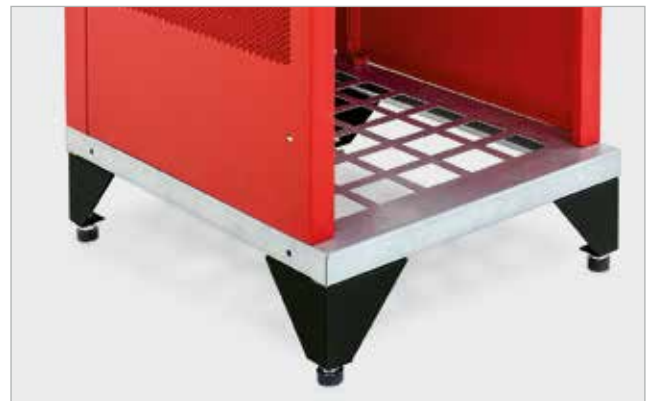



IPE – X2



IPF

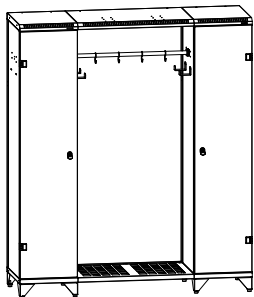

IPE (X2)	
Height x width x depth (mm)	1780 x 1600 x 500
Number of sections	2
Equipment	1 chrome rod, 2 clothes hooks, galvanized steel grate for shoes, belt hook, preparation for helmet holder on top of the locker 1 lockable locker with chrome rod, 2 clothes hooks, 3 doublehooks, 2 shelves, special perforation
Weight net / gross (kg)	113 / 119
Order code	IPE-18-A85-IIC-X2 (cylindrical lock) IPE-18-A85-IIR-X2 (mechanical code lock)

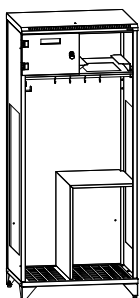

IPF	
Height x width x depth (mm)	1780 x 800 x 600
Number of sections	2
Equipment	1 lockable box, inner helmet holders, chrome rod, 4 clothes hooks, 2 hooks on side inside the locker
Weight net / gross (kg)	62 / 68
Order code	IPF-18-A86-IIC-X1 (cylindrical lock) IPF-18-A86-IIR-X1 (mechanical code lock)



Feuerwehr Buochs Ennetbürgen



Freiwillige Feuerwehr Erpfting



Freiwillige Feuerwehr Munchehof



Feuerwehr Wallenwil/Eschlikon



ZOO Hluboká nad Vltavou



Bayerisches Rotes Kreuz



Bayerisches Rotes Kreuz

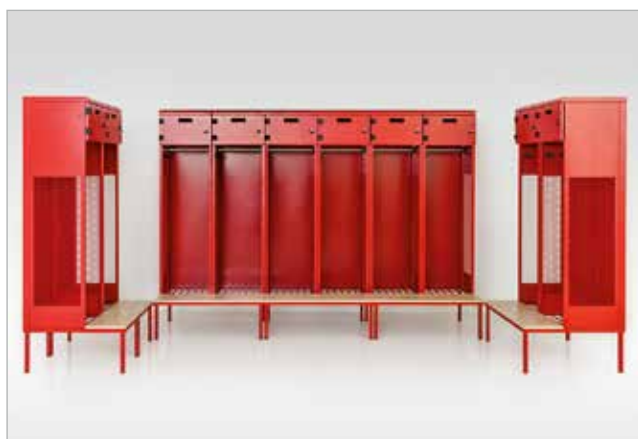

Nordic Lockers

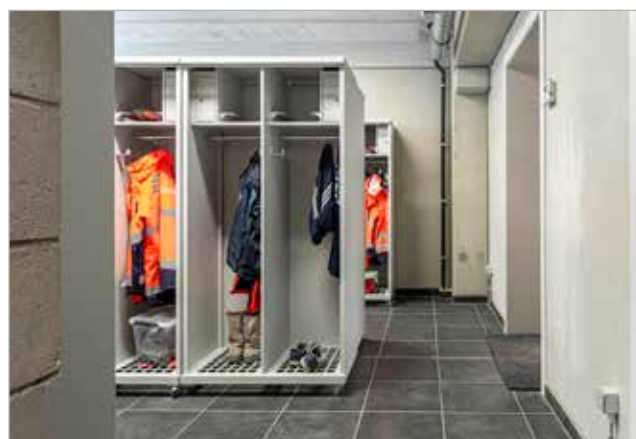

Van Akelyen

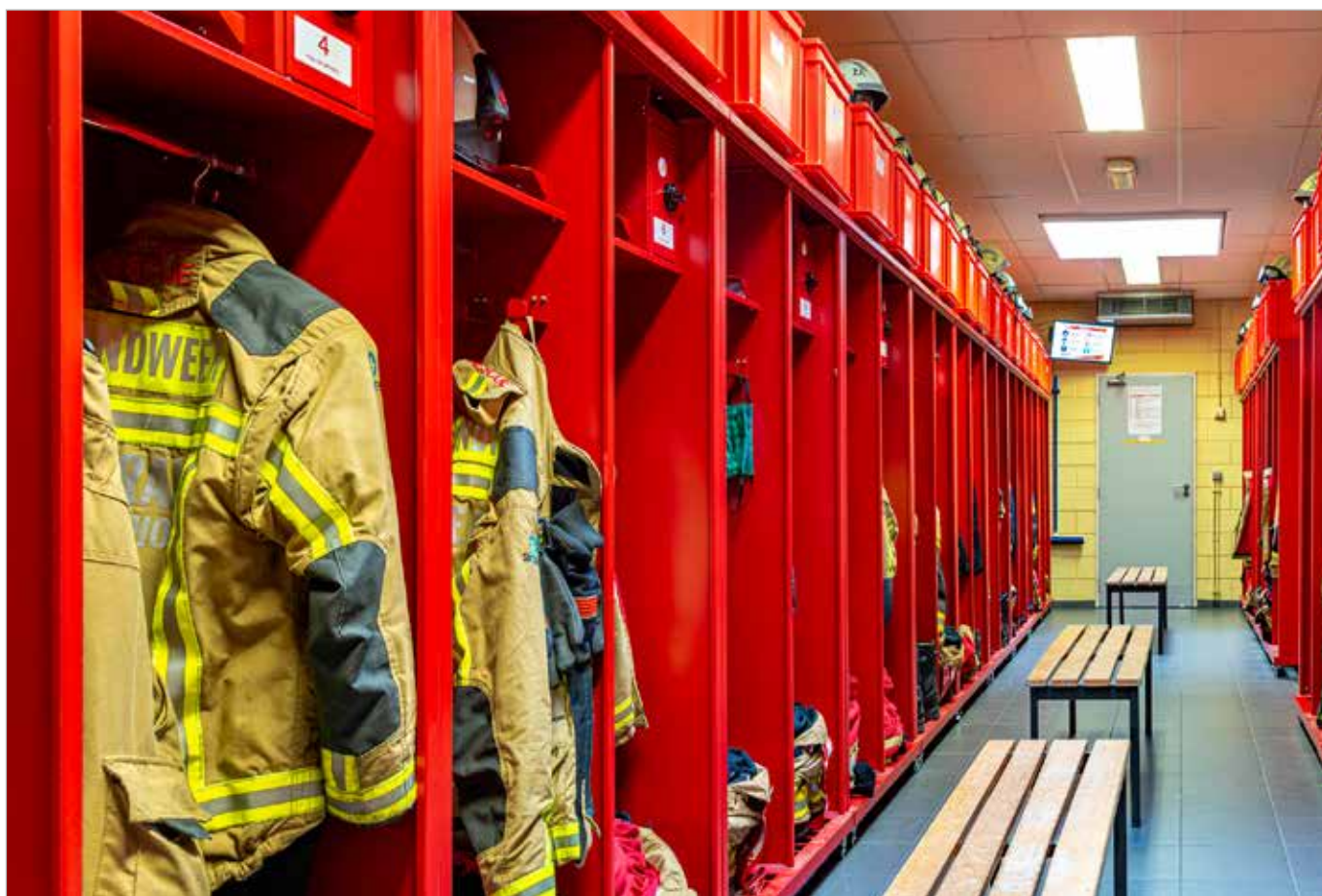

Brandweer Zandhoven



Key lockers

Steel key lockers

with hardened glass doors are used for perfect key management. The locker can be easily mounted to the wall. Hooks are made of steel.

Laminated chipboard key locker

is equipped with steel hooks.. The locker is fitted with cylindrical lock for safe key-storage.



An extended range of decors can be found on page 90.



Key lockers

Height x width x depth (mm)	670 x 370 x 105	670 x 620 x 105	990 x 620 x 105
Number of hooks	50 hooks (5 x line / 10 pcs)	100 hooks (5 x line / 20 pcs)	160 hooks (8 x line / 20 pcs)
Weight (kg)	8	12	18
Order code	IAK-06-C41-XXX-X1	IAK-06-C61-XXX-X1	IAK-09-C61-XXX-X1



Laminated chipboard key locker

Height x width x depth (mm)	615 x 310 x 125	615 x 560 x 125	950 x 560 x 125
Number of hooks	50 hooks (5 x line / 10 pcs)	100 hooks (5 x line / 20 pcs)	160 hooks (8 x line / 20 pcs)
Weight (kg)	8	13	18
Order code	LAK-06-B31-CAA-X1	LAK-06-B51-CAA-X1	LAK-09-B51-CAA-X1



Cloakroom seats

Steel sheet and laminated chipboard combination

Cloakroom benches are used as equipment for changing rooms in facilities, gyms, schools, and sports clubs. They are made of robust 30 x 30 mm steel profiles. The seating area is made out of laminated board with a 2 mm ABS edge. The legs are equipped with plastic glides. The coat hook wall is equipped with practical hooks in the colour of the profiles.



Upon request, it is possible to adapt the structure for shoe storage



An extended range of decors can be found on page 90.



One-sided cloakroom bench with hooks

Height x length x depth (mm)	1800 x 1200 x 430	1800 x 1500 x 430	1800 x 2000 x 430
Number of hooks	8	10	13
Weight net / gross (kg)	67	75	89
Order code	ITV-04-X01-XXX-X3	ITV-04-X02-XXX-X3	ITV-04-X03-XXX-X3

Double-sided cloakroom bench with hooks

Height x length x depth (mm)	1800 x 1200 x 430	1800 x 1500 x 430	1800 x 2000 x 430
Number of hooks	16	20	26
Weight net / gross (kg)	111	121	150
Order code	ITV-08-X01-XXX-X3	ITV-08-X02-XXX-X3	ITV-08-X03-XXX-X3



Cloakroom bench

Height x length x depth (mm)	460 x 1200 x 350	460 x 1500 x 350	460 x 2000 x 350	460 x 2000 x 550
Weight (kg)	14	18	25	26
Order code	ITL-04-X03-XXX-X2	ITL-04-X04-XXX-X2	ITL-04-X05-XXX-X2	ITL-04-X01-XXX-X2



Laminated cloakroom benches





Laminated benches are made of durable laminated chipboard with a thickness of 36 mm and a 2 mm ABS edge.

Thanks to the materials and design used, these benches are suitable especially for spaces where high demands are placed on the overall design of the locker room.



Laminated cloakroom benches

Height x length x depth (mm)	460 x 600 x 350	460 x 800 x 350	460 x 1000 x 350
Weight (kg)	14	16	18
Order code	ILL-04-X01-XXX-X1	ILL-04-X02-XXX-X1	ILL-04-X03-XXX-X1

EGGER		Kronospan STANDART				
	Maple Mandal		Birch 1715 BS	Nagano Oak 8431 SN	Cherry 0344 BS	Walnut 0729 BS
Kronospan CONTEMPO						
	Concrete Flow K350 RT	Light Rockford Hickory K085 PW	Blonde Surfside Ash K525 SN	Gold Baroque Oak K535 RW	Amber Baroque Oak K536 RW	

An extended range of decors can be found on page 90.



Design self-watering flowerpot

- Location:** exterior / interior
- Colour:** anthracite RAL 7016
- Material:** galvanized sheet metal treated with facade powder coating
- Dimensions:** 875 x 850 x 300 mm (W x H x D)
- Included:** 3x self watering plastic set, 2x wheels, 2x rectification legs
- Weight:** 23 kg (including plastic inserts)

Plastic inner liner with self-watering set

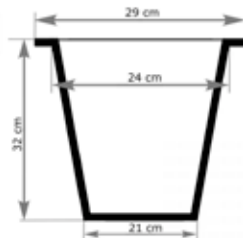

- This set consists of:**
- an inner plastic liner
 - a double bottom (partition)
 - a water level indicator

High-quality and stable plastic is used for the inserts, which makes them suitable for both indoor and outdoor use.

Flower pots:

3x self watering plastic set in black colour with a water level indicator.



Easy handling:

2x wheels for easy movement and 2 x levelling rubber feet to prevent accidental sliding.



Can be additionally ordered:

A set of metal profiles for anchoring the flowerpot (including connecting material).



grey anthracite
RAL7016



Shelf racks

Shelf racks

A versatile wall-mounted rack suitable for use in archives, workshops, and warehouses.

The shelves can be adjusted in 45 mm increments and can hold up to **100 kg**.

The maximum loading capacity of the rack is **500 kg**.

The rack is supplied unassembled, with its individual components.

Welded shelf racks – steel / laminated chipboard combination.

The shelves, made of 18 mm laminated particle board, are inserted into a metal frame.

We recommend securing the unit to the wall with prepared holes on the uprights.

Shelf load capacity: 75 kg

Max. load capacity of the unit: 450 kg



An extended range of decors can be found on page 90.



Shelf racks				
Height x width x depth (mm)	2000 x 1000 x 400	2000 x 1000 x 500	2000 x 1000 x 400	2000 x 1000 x 500
Surface treatment	zinc-coated	zinc-coated	colour	colour
Equipment	5x shelf	5x shelf	5x shelf	5x shelf
Weight net / gross (kg)	38 / 39	44 / 45	29 / 30	34 / 35
Order code	IAR-20-X14-XXX-X1	IAR-20-X15-XXX-X1	IAR-20-X14-CCX-X1	IAR-20-X15-CCX-X1

Welded shelf racks - steel / laminated chipboard	
Height x width x depth (mm)	2000 x 1000 x 500
Surface treatment	lamine
Equipment	6x shelf
Weight net / gross (kg)	63 / 69
Order code	IDR-20-X15-XXX-X1





Workbenches

Universal and flexible work table suitable for workshops, school classrooms, warehouses, and garages.

Adjustable legs for setting the table height in 50 mm increments from 655 up to 1005mm.

Table lengths available (mm): 750, 1200, 1500, 1700, 2000

Table depth for all lengths (mm): 700

Table load capacity (kg): 500 with even weight distribution

Work surface: solid beech wood battenboard with a thickness of 40 mm and chamfered top edges

Sturdy profiled base: welded from steel profiles, with a rear crossbar for added rigidity

Powder-coated metal profile finish: grey RAL7035, blue RAL 5005

Possibility of anchoring the table to the floor.

The table is delivered unassembled with assembly materials included. Easy to assemble.

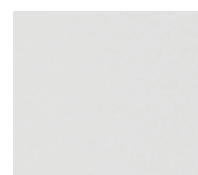

steel grey
(RAL 7035)



steel blue
(RAL 5005)





Workbenches					
Height (mm)	750	1 200	1 500	1 700	2 000
Width x depth (mm)	655 – 1005 x 700	655 – 1005 x 700	655 – 1005 x 700	655 – 1005 x 700	655 – 1005 x 700
Order code					
RAL7035	CXAT20-0056-05	CXAT20-0056-04	CXAT20-0056-03	CXAT20-0056-02	CXAT20-0056-01
RAL 5005	UXAT20-0056-05	UXAT20-0056-04	UXAT20-0056-03	UXAT20-0056-02	UXAT20-0056-01

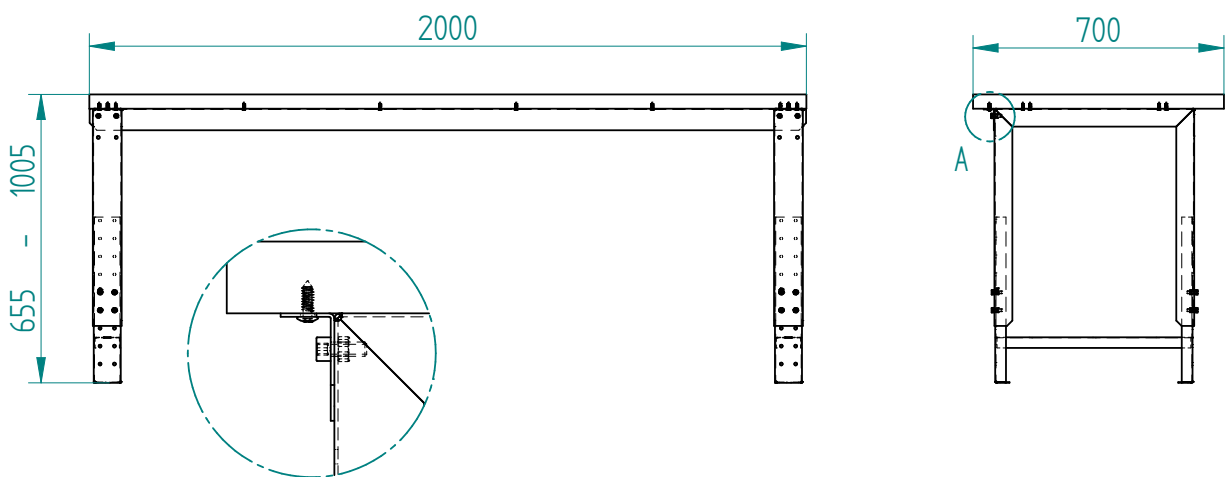



Container for the workbenches

Containers with door and shelf

1x shelf.

Doors with magnets RAL5005.

Doors can be switched to open on the left/right.

Inner shelf adjustable in 21.5 mm increments, secured by 4 M5 screws, upper section gap from 105-190 mm.

Powder-coated surface finish. in grey/blue, RAL 7035/5005.

Drawer containers

4x drawer.

1x upper drawer – internal height 80 mm.

3x lower drawer – internal height 130 mm.

100% telescopic drawer extension.

Drawer load capacity 45 kg.

Powder-coated surface finish. in grey/blue, RAL 7035/5005.



	Order Code	Dimensions W x H x D	Weight (kg)	Colour
Workshop table container 4x drawer	BXAT20-0056-14	570 x 600 x 550	40	black frame, black sockets
Workshop table container 4x drawer	CXAT20-0056-14		40	grey frame, grey drawers
Workshop table container - door	CUAT20-0056-20		26	grey frame, blue door

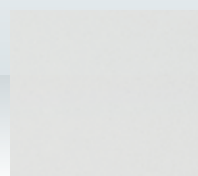

steel grey
(RAL 7035)



steel blue
(RAL 5005)

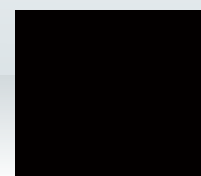

steel black
(RAL 9005)



Additional steel production and cooperation

Mobile cabinet for patients

The cabinet is equipped with a lockable compartment for personal belongings and handles for easy manipulation.

Easy mobility of the entire cabinet during patient transfer is ensured by 4 wheels (2 with brakes).

Thanks to the smooth surface, it is easy to keep the cabinet clean.





Multipurpose storage box

The multipurpose box was developed mainly for storing small items such as wallets, mobile phones, and other valuables that you want to keep safe during your activities. The Burg rotating lock ensures seamless security, preventing unauthorized access. You can safely store your personal belongings without any worries.



Referee table

The laminated table for referees is perfect for all sports venues. It has a large surface and a cable port that allows easy access to power electronic devices. The wheels with brakes ensure easy maneuverability.



Shoe locker

2-door shoe locker intended to be placed under seats of clothes lockers. The boxes can be put one on each other and fix them with screws.

Dimensions: 410 x 512 x 600 mm

Use: intended to be placed under seats of clothes lockers

Locking: 2x cylindrical lock with 2 keys
(possibility of turning lock for padlock)

Frame: welded with perforation

Weight: 14 kg

Order code: IAB-04-C56-XXX-X1



Light frames



Steel bedside cabinets



Material

The wall with modules is made of high-quality steel sheet with a powder-coated smooth surface. The surface is easily maintainable and durable.

Assembly

Easy assembly by simply inserting the hooks on the back of the boxes into the holes in the base plate and securing them with screws.



USAGE:



HEALTH CARE



INDUSTRY



GOVERNMENT



EDUCATION



RESIDENTIAL BUILDINGS

Multifunctional storage wall

for flyers, keys, medications, mail, defibrillator

The plate allows easy fixing of various types of boxes in different number combinations. For example, it can contain only 4 mail boxes and 4 flyer modules. It is always supplied only in a specific combination.

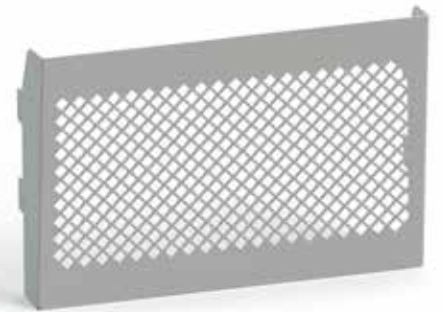
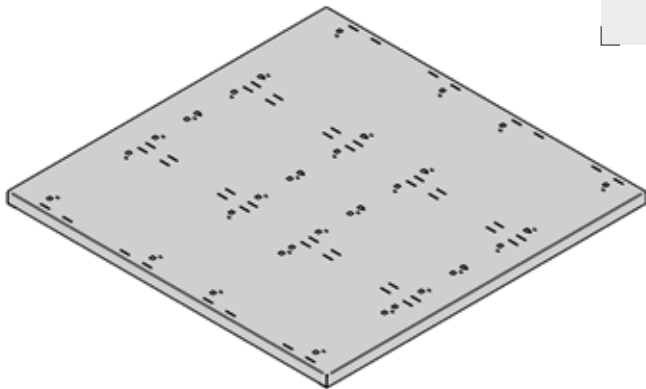

Colour

Hanging modules and plate are supplied in two-colour combination grey/blue or grey/black.

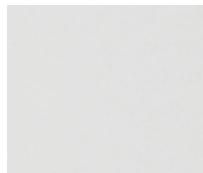

steel grey
(RAL 7035)



steel blue
(RAL 5005)

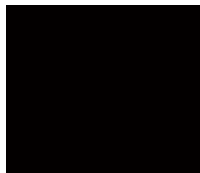

steel black
(RAL 9005)

Modules:

FOR FLYERS
IUS-PR-XXX-XXX-X1

Dimensions
width 285 mm
height 190 mm
depth 54 mm

Weight
0,46 kg

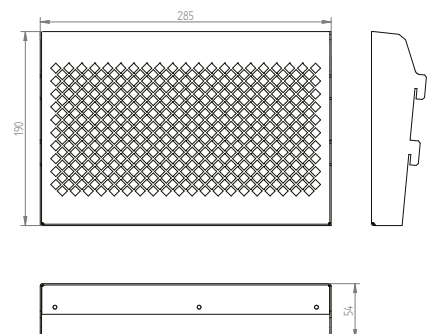

FOR KEYS
IUS-04-K38-XXX-X1

Dimensions

width 300 mm
height 400 mm
depth 60 mm

Weight

3,96 kg

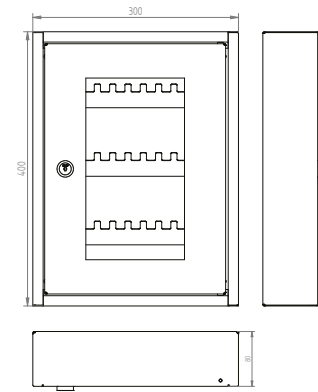

FOR MEDICATIONS
IUS-04-L31-XXX-X1

Dimensions

width 300 mm
height 400 mm
depth 120 mm

Weight

4,00 kg

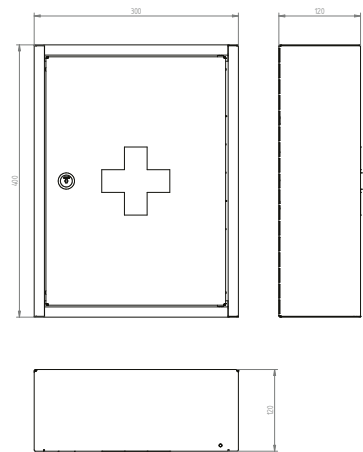

FOR MAIL
IUS-04-P38-XXX-X1

Dimensions

width 300 mm
height 400 mm
depth 60 mm

Weight

3,26 kg

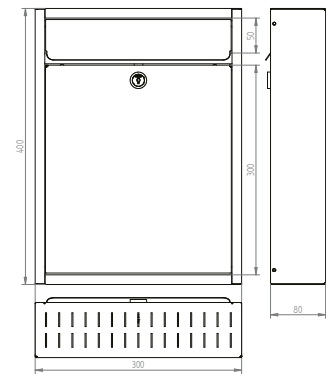

FOR A DEFIBRILLATOR
IUS-04-D52-XXX-X1

Dimensions

width 500 mm
height 400 mm
depth 200 mm

Weight

8,19 kg

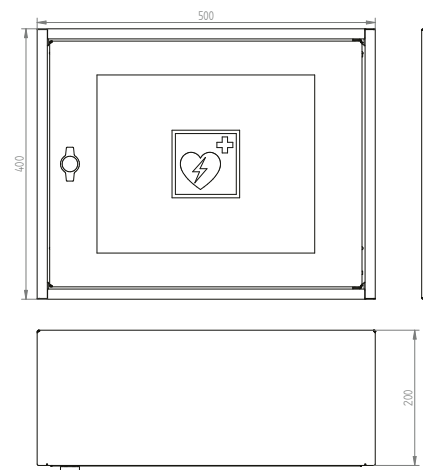

Mail box for smart pickup larger parcels from shipping companies without the presence of the recipient.

The box is locked with a numerical code lock allowing the courier to securely deposit of the parcel using the unique code provided by the recipient.

The box is available in 3 sizes.

All boxes are equipped with levelling feet and holes in the back wall for anchoring to the wall.



**ANTI-Covid
PROGRAM**

Mail box

Optionally, a digital lock can be installed that can be touch-sensitive with up to an 8-digit code, or touch-sensitive with code and fingerprint reader + Bluetooth for remote control via an app on your mobile device.



Colour

The mail box can be ordered in one colour or two-colour combination according to the pattern.

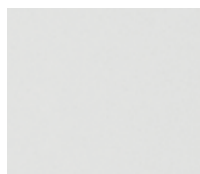
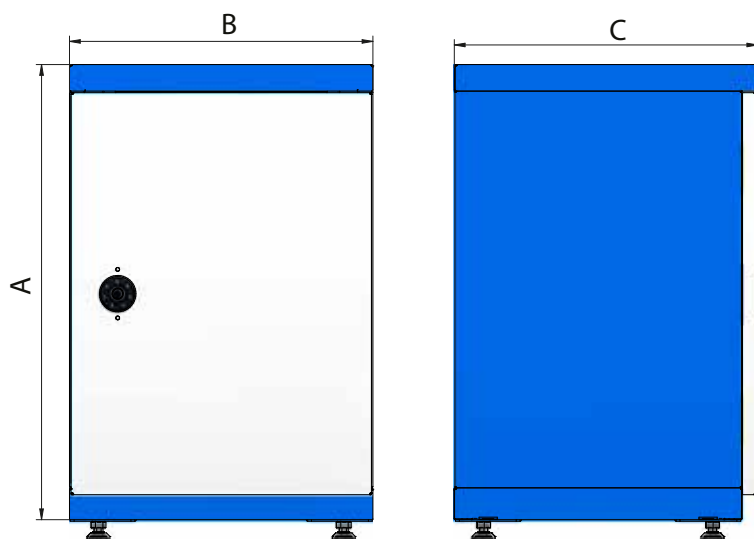

steel grey
(RAL 7035)



steel blue
(RAL 5005)

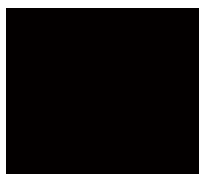

steel black
(RAL 9005)

type	A	B	C	weight
	(mm)			(kg)
IBP-06-A44-XXX-X1	600	400	400	13
IBP-06-A54-XXX-X1	650	500	450	16,21
IBP-10-A66-XXX-X1	1000	600	650	28,54

USAGE:



HEALTH CARE



INDUSTRY



GOVERNMENT



EDUCATION



RESIDENTIAL BUILDINGS

Fully automatic sanitizer dispenser with a motion sensor.

The base of the stand is made of 4mm thick sheet metal, stand profile is made of 2mm thick sheet metal. The welded construction is non-detachable.

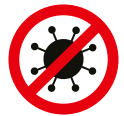

ANTI-Covid
PROGRAM

Sanitizer stand with drip tray

Order Code: IDS-14-X43-XXX-X1

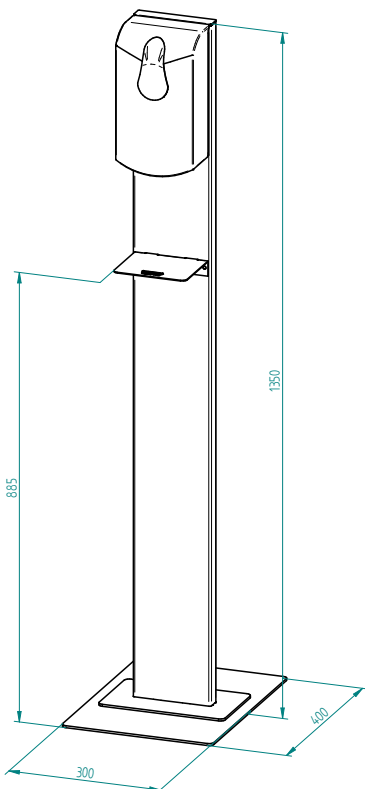

Dimensions
width 300 mm
height 1350 mm
depth 400 mm

Weight
10,48 kg

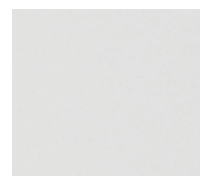

steel grey
(RAL 7035)



steel blue
(RAL 5005)

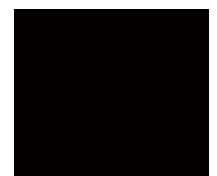

steel black
(RAL 9005)

USAGE:



HEALTHCARE



INDUSTRY



GOVERNMENT



EDUCATION



RESIDENTIAL BUILDINGS

There are two types to choose from disinfectant dispensers : manual or fully automatic with a motion sensor.

Module for the graphic allows you to insert and easily exchange information leaflets in A4 format.

Hygiene stand including waste bin

with preparation for flexible installation of different types of modules:

- Module for the graphic
- Module for paper towels
- Module for the face masks
- Module for tissues or gloves
- Disinfectant dispenser

Hanging modules and plate are supplied in two-colour combination grey/blue or grey/black.

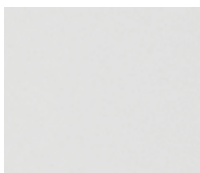

steel grey
(RAL 7035)



steel blue
(RAL 5005)



steel black
(RAL 9005)





**ANTI-Covid
PROGRAM**

Modules

FOR PAPER TOWELS
IDS-PR-XXX-XXX-P4



FOR TISSUES OR GLOVES
IDS-PR-XXX-XXX-P2



FOR THE FACE MASKS
IDS-PR-XXX-XXX-P1



FOR THE GRAPHIC
IDS-PR-XXX-XXX-P3



The plate allows easy fixing of modules with the included screws and nut into the prepared holes.

DISINFECTANT DISPENSER



Manual dispenser
Merida TOP-Spray



Automatic dispenser
AUTOMATIC Merida ONE

STAND INCLUDING WASTE
BIN
IDS-16-X45-XXX-X1

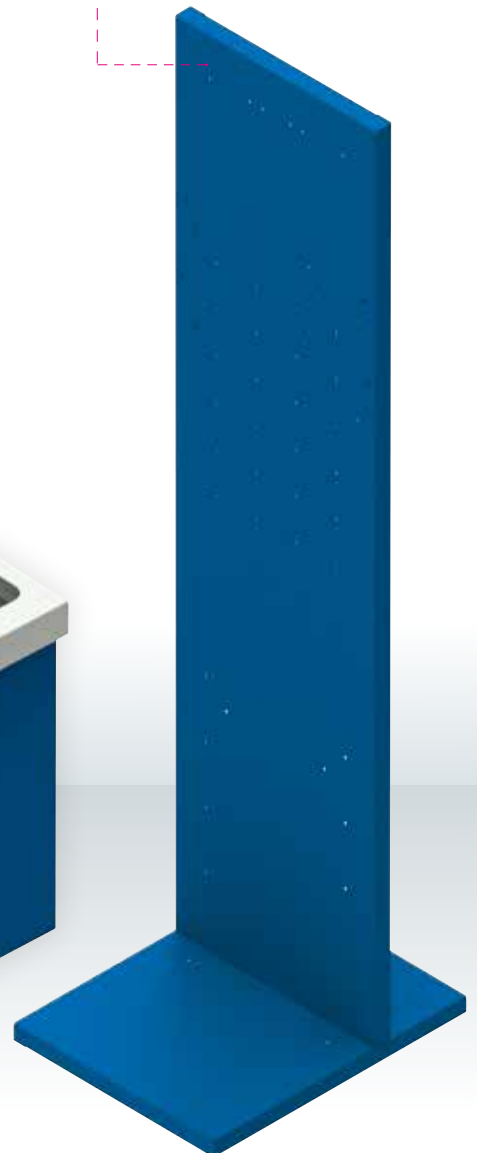

Dimensions:
width 400 mm
height 1600 mm
depth 500 mm

Weight:
16,2 kg including waste
basket



Accessories

Our customers can choose from a wide variety of locker accessories.

Shelves - Steel, Laminate

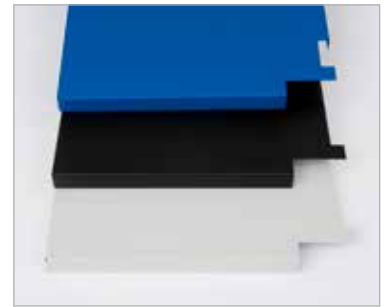

COLOR			
	steel grey (RAL 7035)	steel blue (RAL 5005)	steel black (RAL 9005)

EGGER		Kronospan STANDART				
	Maple Mandal		Birch 1715 BS	Nagano Oak 8431 SN	Cherry 0344 BS	Walnut 0729 BS
Kronospan CONTEMPO						
	Concrete Flow K350 RT	Light Rockford Hickory K085 PW	Blonde Surfside Ash K525 SN	Gold Baroque Oak K535 RW	Amber Baroque Oak K536 RW	

An extended range of decors can be found on page 90.

Plastic shoe pad

Dimensions: 270 x 345 mm
IZN-PV-X23-XXX-X1



Hook „S“

IZN-SS-X03-XXX-X1 - black plastic
IZN-SS-X07-XXX-X2 - steel

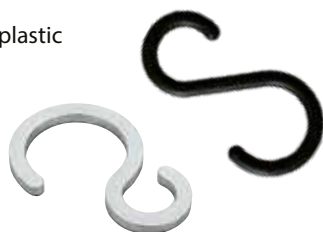

Metal hook „9“

IAI-06-XXX-ZXX-X1



Power distribution units

DIN: RAB-PD-X91-C1
ČSN: RAB-PD-X90-C1



Roof 15°

IAN-01-XX5-XXX-X1

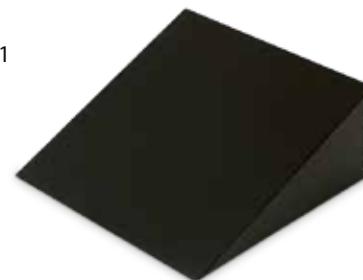

Levelling feet

included in a supply



Connecting set

RAX-MS-X70-X1



Key number tags

Key numbering 01-50:

IZN-SS-X02-XXX-X2

Key numbering 001-100:

IZN-SS-X02-XXX-X3

Stainless steel

key numbering 001-100:

IAI-03-XXX-NXX-X11



Self-adhesive label

IZN-SS-X01-XXX-X2 - blue

IZN-SS-X01-XXX-X3 - black





Locks

Digilock®

DIGILOCK – The company Digilock was founded in 1981 in California. It now boasts high-quality processing, which simplifies security and improves the user environment through innovations, quality, and design, for which the company is highly sought after.

BURG®

BURG – Our specialization is mechanical and electronic locks for both metal and wooden furniture. The company BURG introduces the fourth generation of family business, whose history dates back to 1890 when the first padlock was made. Today, BURG is a modern supplier of locks for a wide range of applications and is one of the leading European manufacturers of lock systems.

Metra.si

Metra – The company Metra is a comprehensive supplier of online locking system solutions, including reading devices, touchscreens, barcodes, QR codes, and software services.

**ACS
Solution**

ACS – The company ACS Solution specializes in comprehensive deliveries, especially in the field of electronic access systems, for hotels, spas, sports centers, residential buildings, manufacturing halls, healthcare and educational facilities, and administrative buildings.

Digilock®



Digilock AXIS Keypad

Digilock AXIS Keypad Slim

The elegant appearance of the lock Digilock brings a clean design with solution for your locking. The lock is keypad operated with either a fixed or multi-user 4 digit code. This eliminates the necessity of keys, smart bracelets, keychains and cards. Also available in slim version.



Digilock AXIS RFID

Digilock AXIS RFID Slim

The elegant appearance of the lock Digilock brings a clean design with solution for your locking. Access with cards or chip bracelets. The lock is RFID operated with either a assigned or free use. Also available in slim version.



Digilock Cue Keypad

The lock is keypad operated with either a fixed or multi-user 4 digit code. This eliminates the necessity of keys, smart bracelets, keychains and cards.



Digilock Cue RFID

Locks are operated by card or chip bracelet. This lock is battery powered and ensures solid security. The lock is RFID operated with either a assigned or free use.



Digilock SOLA Keypad

Keypad operated with a 4-digit custom code. This lock is battery powered and ensures solid security. This eliminates the necessity of keys, smart bracelets, keychains and cards. Locks can be mounted in vertical or horizontal position.



Digilock SOLA RFID

Locks are operated by card or chip bracelet. This lock is battery powered and ensures solid security. The lock is RFID operated with either a assigned or free use. Can be mounted in vertical or horizontal position.



BURG®

Cylindrical lock Burg – for steel

The lock secures the door in its middle part. Locks come standard with two metal keys. Locks can be equipped with a master key system (the master key is universal for locks in laminate and metal).

Order code: IZN-ZK-X24-XXX-X1 – right, left lock
 IZN-ZK-X08-XXX-X1 – master key



Cylindrical lock Burg – for laminated chipboard

The lock secures the door in its middle part. Locks come standard with two metal keys. Locks can be equipped with a master key system (the master key is universal for locks in laminate and metal).

Order code: IZN-ZK-X06-XXX-X1 – right lock
 IZN-ZK-X07-XXX-X1 – left lock
 IZN-ZK-X08-XXX-X1 – master key



Burg turning lock

This lock is secured by a padlock to fix it in a locked position. The recommended shackle diameter of the padlock is 6 mm. The locking mechanism turns freely after inserting the shackle of the padlock, preventing the lock from being forcibly turned in the mounting hole.

Order code: IAZ-ZK-X67-XXX-X1 – right lock
 IAZ-ZK-X66-XXX-X1 – left lock



Turning safety lock Burg

Lock is secured by a padlock to fix it in a locked position. Recommended diameter of the shackle of the padlock is 6 mm. After inserting the shackle of the padlock, the security lock can rotate freely, preventing forced rotation of the lock in the mounting hole.

Order code: IAZ-ZK-X53-XXX-X1



Mechanical code lock Burg sPinLock 510

A lock with a four-digit code with a master key system. This type of lock is recommended especially in places where users do not change frequently (lockers for firefighters, golf lockers).

Order code: IZN-ZK-A20-XXX-X1 – right lock
 IZN-ZK-A21-XXX-X1 – left lock
 IZN-ZK-A22-XXX-X1 – master key



Mechanical code Burg sPinLock 510

Lock with a four-digit code with the option to reset it and a master key system. This type of lock is recommended especially where users do not change frequently (lockers for firefighters, golf lockers).

Order code: IZN-ZK-X26-XXX-X1 – right lock
 IZN-ZK-X25-XXX-X1 – left lock
 IZN-ZK-X22-XXX-X1 – master key



Coin deposit lock Burg

The locking mechanism is designed to accept a deposit of 1 EUR. The key remains locked in the lock until a coin is inserted and the locker is locked. After unlocking the locker, the coin is released and returned or held in the cash box. The key remains locked. Coin-operated locks can be equipped with a master key system, including the cash box.

Order code: IZN-ZK-X11-XXX-X1 – right lock for € 1
 IZN-ZK-X12-XXX-X1 – left lock for € 1
 IZN-ZK-X13-XXX-X1 – master key



Burg Corona

Lock is operated by a card or chip. It is compatible with systems based on 125 kHz frequency or Mifare technology. The lock includes two batteries, LED back light and can be programmed as single or multi-user.

Order code: IAZ-ZK-X60-XXX-X1 – lock for laminated chipboard
 IAZ-ZK-X59-XXX-X1 – lock for steel



FLEXP.RFID

The Flexo.RFID lock allows for MIFARE® Classic 1K and MIFARE® Desfire EV II cards.

Thanks to the same dimensions as mechanical locks (16x19mm), it is possible to easily replace your current mechanical lock with the Flexo.RFID lock. The lock can be installed as a recessed lock. The lock works in free/assigned mode. Other lock functions include access to an external battery (2x VARTA 1/2 AA) and its replacement without dismantling, identification of occupancy for MIFARE® Classic, and indication of low battery.

Order code: IZN-ZK-A30-XXX-X1 – right lock
IZN-ZK-A31-XXX-X1 – left lock



INTRO.RFID

The lock system offers secure locking of cabinets and spaces for valuables in both wooden and steel furniture. Due to the same dimensions as mechanical locks (16x19mm), it is possible to easily replace your current mechanical lock. The lock operates in free/assigned mode. Among the lock functions, there is also access to the external battery (CR2450) and its replacement without dismantling, RFID standards MIFARE® Classic / MIFARE® Desfire EV II, indication of low battery.

Order code: IZN-ZK-A27-XXX-X1



FLEXP.CODE

Flexo Code lock is a universal and innovative design lock that offers individual time control with adjustable closing time and up to 999,999 code variations. Thanks to its identical dimensions to mechanical locks (16x19mm), it is easy to replace your current mechanical lock. The code length is 4-6 numbers. Among the lock's functions are access to an external battery (2x VARTA 1/2 AA), definable lock functionality time, high-quality keypad, and indication of a low battery.

Order code: IZN-ZK-A28-XXX-X1 – right lock
IZN-ZK-A29-XXX-X1 – left lock



INTRO.CODE

The locking system offers secure locking of cabinets and spaces for valuables in wooden and steel furniture. The code length is 4-15 digits. Due to the same dimensions as mechanical locks (16x19mm), it is easy to replace your current mechanical lock. The lock also features access to an external battery (CR2450) and its replacement without dismantling, and indication of a low battery.

Order code: IIZN-ZK-A26-XXX-X1



ACS 19-HU

The digital lock from ACS Solution offers a mode of fixed assigned lockers, as well as free selection. It has an almost all-metal, highly durable construction, with an ideal price-performance ratio.



KERONG

A digital lock that can be operated by touch with up to an 8-digit code, or touch with a code and fingerprint reader or RFID with a numeric code, fingerprint reader + Bluetooth for remote control via an app on a mobile device.

Order Code: IZN-ZK-A10-XXX-X1 – lock with numeric code
IZN-ZK-A11-XXX-X1 – with numeric code, fingerprint
IZN-ZK-A12-XXX-X1 – RFID with numeric code, fingerprint, Bluetooth



The eco-friendly locker system which saves time, money and stress.

No on-locker management, no broken keys/locks, no need to change harmful lock batteries, etc.

Intelligent, secure, low-maintenance, centrally managed and most user-friendly locker system for storage and delivery lockers in modern offices, smart buildings and other facilities of any size.



Metra electronic lock

Central unlocking of individual lockers
Fully concealed (not visible on doors)
Open locker doors to left, right, up, down and front (for electronic drawers)
Vandal-proof (no direct access to lock)
With Auto-Open, Push-Open or Pull-Open locker door dynamics Electric motor-driven (highly reliable) Self-test at every use (each lock/unlock)



Metra electronic lock with RFID reader

For on-door unlocking lockers
Status lights (vacant, occupied, alarm, etc.)
Open locker doors to left, right, up, down and front (for electronic drawers)
Vandal-proof (no direct access to lock)
With Auto-Open, Push-Open or Pull-Open locker door dynamics
Electric motor-driven (highly reliable)
Self-test at every use (each unlock)



Metra Display

Central unlocking of individual lockers
For daily (random visitors) or long-term locker use (employees, students, etc.)
RFID media/4 -digit PIN Code as locker key
Used as standalone or with Metra Readers
Embedded washable keypad
Built-in RFID reader
4-digit LED display
Used with Metra electronic locks



Metra Touch Display

Central unlocking of individual lockers
For activity-based/co-working type lockers
User occupies a vacant locker by himself
10" touch screen with Full HD resolution
Multilanguage functionality
Custom branding of screens (optional)
For storage and delivery locker system
Horizontal or Vertical position
Used as standalone or with Metra Readers



Metra Reader

For Metra Display/Metra Touch Display
Central unlocking of individual lockers
Enables the use of various locker keys
Use multiple locker keys for single locker
Reader ISO (ISO RFID)
Reader Multi (99,9% of RFID) LE (Legic™ RFID)
Barcode (Barcode, QR Code)
With genuine HID™ Tech. (HID™ RFID)



MyMetraKey mobile app

For remote unlocking of individual lockers
For activity-based or long-term lockers
Remote locker use and management Manage multiple lockers from single app
Enables fully clean-line lockers
No Metra Displays/Metra Readers needed
As a sole locker key or in combination with secondary key (PIN code, RFID, etc.) For iOS and Android



Metra Locker Management Software

Complete remote management and overview of all user and locker activities
Remotely add/remove media and users
Remotely unlock any locker or lockers
For various locker solutions (Daily lockers, Rental lockers, Workplace Lockers and Delivery/Parcel lockers)
Detailed reports and statistics (optimizing employee locker usage)

Metra locker system for any solution

Daily lockers (daily guests and visitors)

Rental lockers (renting out lockers)

Workplace lockers (employees, students)

Delivery and Pickup lockers (parcel)

Integrate with any third-party system

Access control, time and attendance, payment, cashless vending, facility, etc.

The offer of Kronospan Contempo decors

NEW



K349 RT
Silk Flow



K524 SN
Pure Surfside Ash



K083 SN
Light Artwood



K085 PW
Light Rockford Hickory



K543 SN
Sand Barbera Oak



K525 SN
Blonde Surfside Ash



K358 PW
Honey Castello Oak



K360 PW
Vintage Harbor Oak



K535 RW
Gold Baroque Oak



5527 SN
Stone Oak



K086 PW
Natural Rockford Hickory



5501 SN
Slavonia Oak



K536 RW
Amber Baroque Oak



K548 RW
Smoked Kala Ash



K546 RW
Caramel Franklin Walnut



K547 RW
Tobacco Franklin Walnut



K541 PN
Greige Tessea



K542 PN
Mocha Tessea



K084 SN
Dark Artwood



K538 PN
Dovetail Arosa



K350 RT
Concrete Flow



4298 SU
Light Atelier



K540 PN
Grey Albus



K352 RT
Iron Flow



K022 SN
Satin Blackwood



K107 PW
Elegance Endgrain Oak



K357 PW
Greige Castello Oak



K355 PW
Platinum Grange Oak



K105 PW
Raw Endgrain Oak



K544 RW
Hazel Silverjack Oak



K356 PW
Sand Grange Oak



K087 PW
Dark Rockford Hickory



K361 PW
Gold Harbor Oak



K021 SN
Barley Blackwood



K359 PW
Brandy Castello Oak



K545 RW
Vintage Silverjack Oak



K354 PW
Colonial Grange Oak



K537 RW
Ristretto Baroque Oak



K526 SN
Iron Surfside Ash



K539 PN
Fossil Arosa



K351 RT
Rusty Flow



4299 SU
Dark Atelier



K353 RT
Charcoal Flow



The offer of Kronospan Standard decors

NEW



K010 SN
White Loft Pine



K001 PW
White Craft Oak



K088 PW
White Nordic Wood



K080 PW
White Coastland Oak



5529 SN
Oregon



K081 PW
Satin Coastland Oak



K002 PW
Grey Craft Oak



K005 PW
Oyster Urban Oak



K012 SU
Pearl Artisan Beech



8921 BS
Ferrara Oak



K013 SU
Sand Artisan Beech



3025 SN
Light Sonoma Oak



1715 BS
Birch



0375 BS
Maple



8431 SN
Nagano Oak



8995 SN
Coco Bolo



K003 PW
Gold Craft Oak



K365 PW
Coast Evoke Oak



K078 PW
Dark Riverside Cherry



9614 BS
Light Lyon Walnut

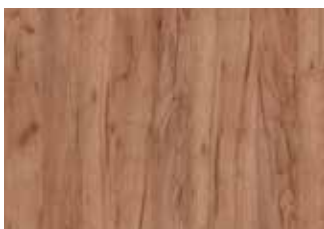

K004 PW
Tobacco Craft Oak



K009 PW
Dark Select Walnut



8953 SU
Tiepolo Walnut



K015 PW
Vintage Marine Wood



K019 PW
Silver Liberty Elm



K079 PW
Grey Clubhouse Oak



K089 PW
Grey Nordic Wood



K366 PW
Fossil Evoke Oak



K017 PW
Blonde Liberty Elm



5194 SN
Oxide Vintage Oak



K018 PW
Smoked Liberty Elm



K007 PW
Coffee Urban Oak



K006 PW
Amber Urban Oak



K076 PW
Sand Expressive Oak



5500 SU
Natural Noble Elm



K008 PW
Light Select Walnut



0381 BS
Bavaria Beech



1912 BS
Alder



0344 BS
Cherry



K020 PW
Fireside Select Walnut



0729 BS
Walnut



K082 PW
Bourbon Oak



0854 BS
Wenge



9763 BS
Louisiana Wenge



K090 PW
Bronze Expressive Oak



7648 SN
Vintage Wenge



8548 SN
Finline Mocca



K016 PW
Carbon Marine Wood

The offer of Kronospan Color decors

NEW



8681 SU
Brilliant White



0110 SM
White



0101 PE
Front White



8685 BS
Snow White

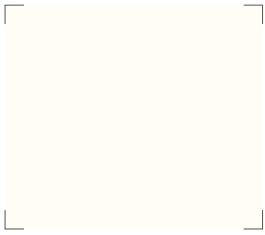

8100 SM
Pearl White

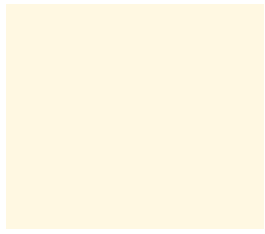

0564 PE
Almond



7045 SU
Satin



5981 BS
Cashmere



0540 PE
Manhattan Grey



0197 SU
Chinchilla Grey

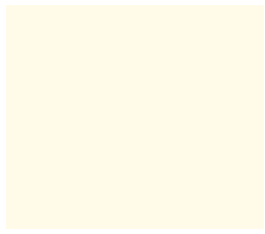

7031 BS
Crème

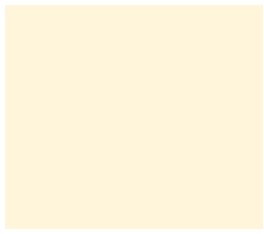

0514 PE
Ivory



0522 PE
Beige



5982 BS
Mussel



0515 PE
Sand



0134 BS
Sunshine



K516 SU
Toffee



0132 BS
Orange



7113 BS
Chilli Red



K514 SU
Deep Sahara



K513 SU
Marshmallow



K512 SU
Native Pink



K518 SU
Surf Blue



K517 SU
Azure Blue



0125 BS
Royal Blue



7063 SU
Pastel Green



K097 SU
Dusk Blue



7190 BS
Mamba Green



9561 BS
Oxide Green



K521 SU
Smoke Green

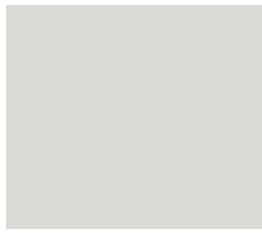

0191 SU
Cool Grey



0112 PE
Stone Grey



1700 PE
Steel Grey



K522 PE
Aluminium Flash



K523 PE
Platinum Disk



K519 SU
Mouse Grey



0171 PE
Slate Grey



0162 PE
Graphite Grey



0164 PE
Anthracite



0190 PE
Black



8533 BS
Macchiato



0301 SU
Cappuccino

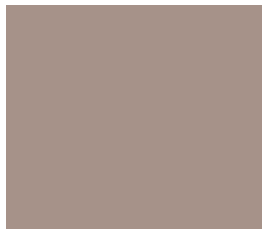

K096 SU
Clay Grey

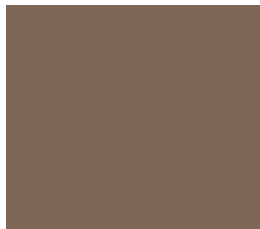

7166 BS
Latté

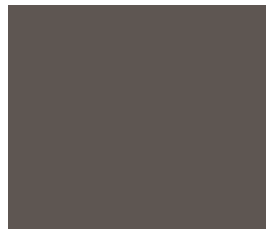

6299 BS
Cobalt Grey



K098 SU
Ceramic Red

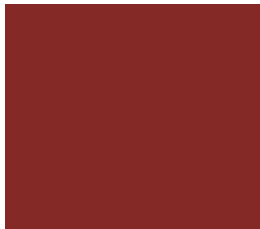

9551 BS
Oxide Red

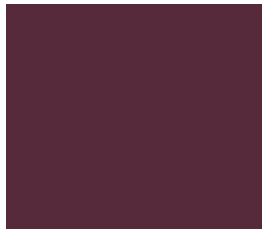

K515 SU
Spice Red



5994 SU
Alby Blue



8984 BS
Navy Blue

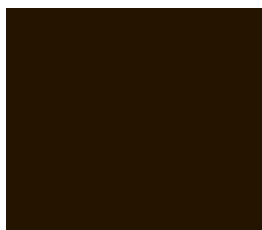

7181 BS
Dark Chocolate



0244 SU
Petrol



K520 SU
Dark Emerald

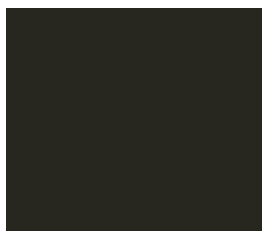

0166 BS
Basalt



References



Moving World Prague



Bohemilk - Dairy Opočno



FF Mulda



Magna Exteriors & Interiors



Star Fitness Mulhouse



Zoom Cycle Praha



Golfplatz Moossee



Grandhotel Hradec, Pec pod Sněžkou



APAG Elektronik s.r.o.



APAG Elektronik s.r.o.



Van Leeuwen



Magna Exteriors & Interiors



Elementary School Průhonice



Library VŠE, Praha



3D Yoga Pardubice



Mergon Czech s.r.o.



Office building Vinice



Vyncke s.r.o.



Elementary School Pardubice - Polabiny, Npor. Eliáše



Förderschule Schönebeck



KOS WIRE EUROPE



Hardcore Gym Aarau



Golf Resort Lipiny



Tongo, Hradec Králové



Sportcentrum Ivanovice



Schrack Technik GmbH



Jarý s.r.o.







Fitness und Freizeitwelt Progress

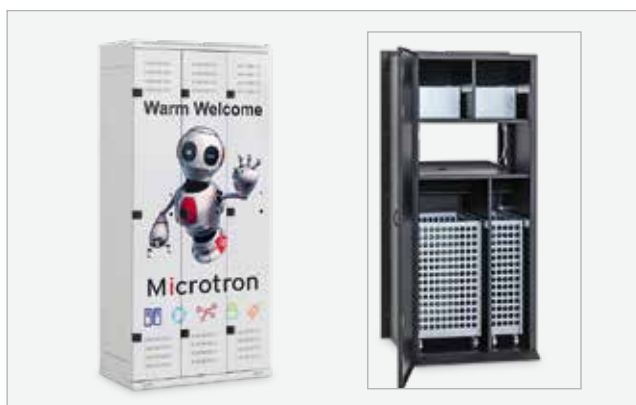

TRITON

Ausstattung von
Umkleideräumen, Metallmöbel



www.garderoenspinde.de



www.dotheslockers.eu



www.satniskrinky.cz



Marketing – Exhibitions

Triton Pardubice, spol. s r. o. has been participating in exhibitions, starting with its first in 1995.

International fair FIBO

- Cologne 2011 - 2015

International fair for firefighters Interschutz

- Hannover 2010, 2015

International exhibition for firefighters Florian

- Karlsruhe 2013, Dresden 2014, 2016, 2018

International fair for living Mobitex

- Brno 2008 - 2010

In cooperation with our business partners our products were also presented at:

International fair for integrated emergency system Infopol -

Kortrijk 2015, 2017, 2019

- **Sport Achat** - Lyon 2019

- **Mountain Planet** - Grenobl 2018

- **ISPO** - Munich 2017

- **Health & Care** - Ghent 2016

- **SportsFair** - Fredericia 2016

- **FSB** - Cologne 2015

- **Suisse Public** - Bern 2013, 2015

- **Sport Achat** - Lyon 2015

- **Golf Europe** - Augsburg, 2012, 2013, 2014

- **Euro Attractions Show** - Paris 2013,
Amsterdam 2014, Göteborg 2015

- **Green Expo** - Paris 2013

- **Golfshow** - Praha 2011

- **Vienna tec** - Vienna 2012

- **GaLaBau** - Nuremberg 2016



The International Fitness Trade Fair FIBO 2012 - Essen, Germany



MOBITEX 2010 - International Trade Fair of Living – Brno



SUISSE PUBLIC 2013



SportsFair 2016



The International Fitness Trade Fair FIBO 2013 - Cologne, Germany



Presentation

Tritón showroom

There is no better argument for a product than a demonstration of a sample. For this purpose, we have set up a presentation centre with samples of our products: laminate, steel and modular clothes lockers, hockey boxes, ski and snowboard lockers and other products.





Packaging, transportation

Packaging

We supply our products in special packaging. The edges are protected by highly durable polyurethane foam, and the entire product is then protected by shrink wrap from dust and scratching during transport. The cabinets are distributed on wooden pallets.

Transportation

We provide the transportation of goods either through our own vehicles or in collaboration with contracted transporters.



Project realization

Our company provides complete delivery of your order – from professional consultation and production of the product of your choice, to transportation with our own vehicle fleet or a contracted transporter, including unpacking and placement of cabinets in the desired location.

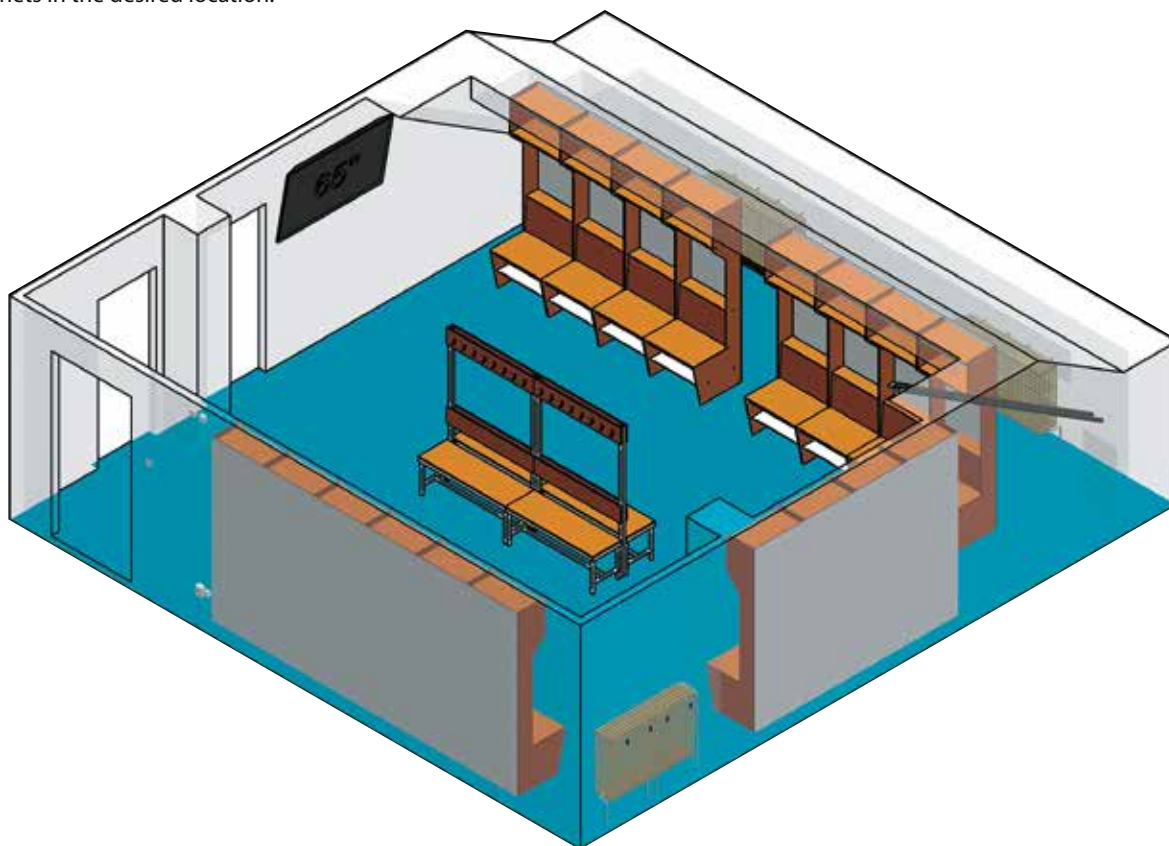

Technical Support

We are happy to provide you with professional assistance in selecting the appropriate product. Based on your specific requirements, we will suggest the most suitable dimensions, construction, and optimal locking system. If necessary, we will measure your space and develop graphic designs with the selected solution.

Production

Our own production takes place on automated CNC machines, which increases the quality and precision of our products. It is important for us that each project meets the customer's expectations, therefore, all additional equipment such as locker labeling, keys, hooks, leveling feet, and other accessories are included in the order upon customer's request.

Transport

We use our own vehicle fleet or a contracted transporter for the transportation of our products. Depending on the location and transportation dimensions of the order, we choose the best method of transportation. Many projects are carried out at locations where the use of a hydraulic head for unloading the goods is necessary.



Assembly

The final step in the successful completion of a project is the unpacking and placement of lockers in the designated location. All packaging material will be taken back with us.

Certificates



ISO 9001:2015



ISO 14001:2015



ISO 45001:2018



Tritón Pardubice, spol. s r. o.

č.p. 130, 530 02 Starý Mateřov

Czech Republic

Tel.: +420 467 401 111

E-mail: info@satniskrinky.cz

www.triton-racks.com

www.clotheslockers.eu