



Advanced Radio Modules

Serial / Ethernet radio Modem ARM-SE

User Guide



Concerned model:
ARM/868-SE



ATIM Radiocommunications
Chemin des Guillets
38250 Villard de Lans
France

www.atim.com
info@atim.com



TABLE OF CONTENTS

Document version history	3
Disclaimer	3
Trademarks and copyright.....	3
Declaration of compliance	4
Environmental recommendations.....	4
Explosive atmosphere	4
Environment.....	4
Radio.....	5
Generalities	6
Radio regulation	7
Context	7
Information on the regulation of conformity.....	7
1. Technical characteristics.....	9
2. Installation	11
a) Warnings.....	11
b) Antenna	13
c) Mounting.....	14
i. On cabinet	14
ii. Exterior antenna (mast).....	15
d) Radiation pattern	16
e) Alignment of the antenna	18
f) Radio channel selection.....	19
3. Connections and links.....	20
a) Power supply	21
b) Installation instructions.....	21
c) Ethernet link	22
d) Serial link RS232	22
e) Serial link RS485	23
f) Dry contacts.....	24
4. Configuration	25
a) Configuration by embedded web pages	25
b) Homepage and password	27
5. Operating mode.....	28
a) Serie.....	28

i. Setup.....	29
b) Repeater	31
i. Synoptic	31
ii. Filtering.....	32
iii. Limitations	32
iv. Setup.....	33
c) Gateway Modbus	34
i. Local target	35
ii. Serial link target.....	35
iii. Target on remote radio modem	35
iv. Settings	36
6. Firmware update	39
7. Update of embedded web pages	41
8. Save parameters and return to factory settings.....	43
9. Radio frequency table.....	44

Document version history

Version	Date	Description	Author
2.2	22/10/2015	Creation of the User Guide	TL
2.3	05/12/2019	Datalogging option deletion	MD

Disclaimer

The information contained in this document is subject to change without warning and does not represent a commitment on the part of ATIM radiocommunications. ATIM radiocommunications provides this document 'as-is' with no warranty of any kind, express or implied, including but not limited to implied warranties of merchantability or fitness for a particular purpose. ATIM radiocommunications may make changes and/or improvements to this manual or to the product(s) or program(s) described in this manual, at any time.

Trademarks and copyright

ATIM radiocommunications®, ACW ATIM Cloud Wireless® and ARM Advanced Radio Modem® are registered trademarks of ATIM SARL in France. The other trademarks mentioned in this document are the property of their respective owners.

Declaration of compliance

All ACW Atim Cloud Wireless® products comply with the regulatory requirements of the R&TTE Directive (1999/5/EC), article 3:



1 SAFETY (Article 3.1a of the 1999/5/EC Directive)

NF EN60950-1 Ed. 2006/A1:2010/A11:2009/A12:2011 (health)

EN62479: 2010 (power <20mW) or EN62311:2008 (power > 20mW)

2 Electromagnetic compatibility (Article 3.1b of the 1999/5/EC Directive)

EN 301489-3 v1.4.1, EN 301489-1 V1.9.2

3 Efficient use of the radio frequency spectrum (Art.3.2 of the 1999/5/EC Directive)

ETSI EN300 220-2 v2.4.1 and EN300 220-1 v2.4.1

Environmental recommendations

Explosive atmosphere

Except for the ACW-ATEX line specifically intended for this purpose, do not use ARM radio modems in the presence of flammable gases or fumes. Using the equipment in such an environment constitutes a safety hazard.

Environment

Respect the temperature ranges for storage and operation of all products. Failing to respect these guidelines could disrupt device operation or damage the equipment. ACW products in IP65 water- and dust-resistant housings may be placed outdoors, but must not, under any circumstances, be submerged.

Follow the instructions and warnings provided below to ensure your own safety and that of the environment and to protect your device from any potential damage.



General hazard – Failure to follow the instructions presents a risk of equipment damage.



Electrical hazard – Failure to follow the instructions presents a risk of electrocution and physical injury.



Direct-current symbol



WARNING: do not install this equipment near any source of heat or any source of humidity.



WARNING: for your safety, it is essential that this equipment be switched off and disconnected from mains power before carrying out any technical operation on it.



WARNING: the safe operation of this product is ensured only when it is operated in accordance with its intended use. Maintenance may only be performed by qualified personnel.



Waste disposal by users in private households within the European Union. This symbol appears on a product or its packaging to indicate that the product may not be discarded with another household waste. Rather, it is your responsibility to dispose of this product by bringing it to a designated collection point for the recycling of electrical and electronic devices. Collection and recycling waste separately at the time you dispose of it helps to conserve natural resources and ensure a recycling process that respects human health and the environment. For more information on the recycling centre closest to your home, contact your closest local government office, your local waste management service or the business from which you purchased the product.

Radio

Modems in the ARM line are radio-communication modems that use the ISM (industrial, scientific and medical) bands, which may be used freely (at no cost and with no authorization required) for industrial, scientific and medical applications.

Generalities

ARM radio modems are manufactured in accordance with the current state of the art and in compliance with the rules of recognized safety and in force in the labor code.

General safety requirements must be observed during all phases of equipment use and repair. Failure to comply with the rules or warnings in this manual is contrary to the safe use and normal operation requirements of ARM radio modems.

As a user of this product, it is necessary to strictly follow all warnings and requirements in your work environment to perform safe operations on ARM radio modems.

Be sure to read this entire manual before operating an ARM-SE radio modem. This manual is part of the ARMSE radio modem and comes with it. The rules for the prevention of risks and accidents as well as the safety rules must be respected!

1. The purpose of a radio modem is to replace a wired link by establishing H.F. (High Frequency) communication between 2 or more remote points.
2. The A.R.M. Radio Modem responds to strong demand in this area by offering excellent performance. It remains open to many expansion and configuration possibilities as well as a choice of the frequency band used
3. A.R.M. can intervene in multiple situations such as remote control, monitoring, telemetry, data transfer, etc. It can be used wherever the wiring is delicate and expensive (dams, isolated weather stations, ski slopes, ...), as well as in mobile applications (vehicles, Conveyors, cranes, cranes, robotics, etc.).
4. Its versatility allows it to either convey information from one point to another, or to manage different types of input outputs over long distances. Its modularity allows it to add standard input / output modules or even specific modules on request.

Radio regulation

Context

Modems of the ARM and ACW family are part of radiocommunications using ISM (Medical Scientific Industry) bands which can be used freely (free of charge and without authorization) for industrial, scientific and medical applications.

As a result, regulation at the national and global level is carried out with the aim of controlling the problems caused by interference and saturation of the frequency bands. At the national level, legislation is provided by both ANFR (National Frequency Agency) and ART (Telecommunications Regulatory Authority). ANFR, created in 1996, develops and publishes the national frequency band distribution table based on the radiocommunication regulations developed within the ITU.

Concerning the field of civil applications, the conditions of use are fixed by the ART which decides the allocation of the frequencies according to a planning. The planning consists of a division by region in which a division by band is established. Then the dedicated radiocommunication services and the list of operators or operators are defined. A distinction by category is made, there are the ministries (Defense, Research, Interior), the ART and the CSA.

Information on the regulation of conformity

The use of radio frequencies is limited by national regulations. The radio modules are designed to comply with the EU Radio & Telecommunications Terminal Equipment Directive 1999/5 / EC and can be used freely in the European Union. Nevertheless, restrictions on RF power or duty cycle may apply. The ARM-N8 is a radio module designed to be incorporated into other products (also called "Finished Products"). According to the R & TTE Directive, the declaration of conformity with essential requirements of the R & TTE Directive are the responsibility of the manufacturer of the final product. A declaration of conformity for the radio module is available at ATIM on request. Applicable regulatory requirements are subject to change. ATIM does not take any responsibility for the accuracy and precision of the above information.

National laws and regulations, as well as their interpretation, may vary by country. In case of uncertainty, it is recommended to consult the local authorities.

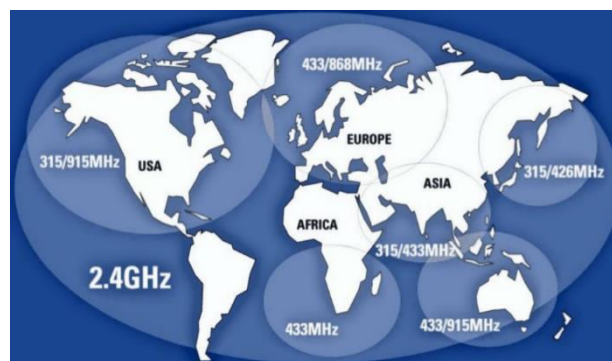

Figure 1 : Use of ISM tapes in the world

Frequency Band		Power/Magnetic Field	Spectrum access and mitigation requirements	Modulation/ maximum occupied bandwidth	ECC/ERC Decision	Notes
g1	863-870 MHz (notes 3 and 4)	25 mW e.r.p.	≤ 0.1% duty cycle or LBT (notes 1 and 5)	≤ 100 kHz for 47 or more channels (note 2)		FHSS
		25 mW e.r.p. Power density: -4.5 dBm/100kHz (note 7)	≤ 0.1% duty cycle or LBT+AFA (notes 1, 5 and 6)	No spacing		DSSS and other wideband techniques other than FHSS
		25 mW e.r.p.	≤ 0.1% duty cycle or LBT+AFA (notes 1 and 5)	≤ 100 kHz, for 1 or more channels modulation bandwidth ≤ 300 kHz (note 2)		Narrow /wide-band modulation
g1.1	868-868.6 MHz (note 4)	25 mW e.r.p.	≤ 1% duty cycle or LBT+AFA (note 1)	No spacing, for 1 or more channels (note 2)		Narrow / wide band modulation. No channel spacing, however, the whole stated frequency band may be used
g1.2	868.7-869.2 MHz (note 4)	25 mW e.r.p.	≤ 0.1% duty cycle or LBT+AFA (note 1)	No spacing, for 1 or more channels (note 2)		Narrow / wide band modulation. No channel spacing, however, the whole stated frequency band may be used
g1.3	869.4-869.65 MHz	500 mW e.r.p.	≤ 10% duty cycle or LBT+AFA (note 1)	No spacing, for 1 or more channels		Narrow / wide band modulation The whole stated frequency band may be used as 1 channel for high speed data transmission
g1.4	869.7-870 MHz (note 11)	<u>5 mW e.r.p.</u> 25 mW e.r.p.	<u>No requirement</u> ≤1% duty cycle or LBT+AFA (note 1)	No spacing for 1 or more channels		Narrow / wide band modulation. No channel spacing, however, the whole stated frequency band may be used

Frequency bands applicable in the 868MHz band for « Non-specific short-range devices » specified in Recommendation ERC 70-03, [2].

1. Technical characteristics

i. General features

Gestion Liaison Ethernet et Liaison série
Transferts Radio Half Duplex
Fréquence 868Mhz
Débit radio 1200bps à 57600bps
Liaison série RS232 RS485 Débit : 1200bps à 115000bps
Puissance radio de 0 à 27dBm à 868Mhz
Mode de Fonctionnement Ethernet, Série, Passerelle
Configuration par Page Web
Mode répéteur simple
Contrôle radio LBT (Listen Before Talk)

ii. ARM-SE

<i>Dimensions</i>	105 x 105 x 31 mm	
<i>Antenna</i>	SMA Connector	
<i>Temperature</i>	-20°C to +55°C (operating) -40°C à +70°C (storage)	
<i>Fixing</i>	DIN Rail	
<i>Power supply</i>	+10/30 Vdc	
<i>Weight</i>	300g	
<i>Frequency</i>	865 – 870 MHz	
<i>Radio output power</i>	500 mW (27 dBm)	
<i>Data baudrate</i>	1.2 to 115 Kbit/s	
<i>Normal mode power consumption</i>	Tx 800 mA/300ms	Rx 150 mA
<i>Sleep mode power consumption</i>	NC	

iii. Radio module

<i>Frequency band</i>	868 – 870 MHz	
<i>N° of channels [868 – 870 MHz]</i>	553 channels available (narrow band)	
<i>Modulation type</i>	2GFSK or 4GFSK	
<i>Power</i>	5mW, 25mW, 500mW depending on the radio channel	
<i>Power stability</i>	+/- 1dBm	
<i>Reception sensibility</i>	-124 dBm (1k2), -116 dBm (19k2)	
<i>Antenna connector</i>	SMA	

iv. Link interface

<i>Ethernet Interface</i>	Connector RJ45 10 Base T Isolated
<i>Interface RS232</i>	SUB-D 9 female pins
<i>Interface RS485</i>	Terminal block connector
<i>Serial link rate</i>	1200 bps to 115000 bps
<i>MOSFET output</i>	+10/30 Vdc

v. Time delays

<i>Modem wake-up time</i>	3.2s
<i>Turnaround time Rx/Tx and Tx/Rx</i>	2.4ms
<i>Time delays RS232 Rx/Tx and Tx/Rx</i>	0ms
<i>Time delays RS485 Rx/Tx and Tx/Rx</i>	<1ms
<i>Transmission delay in Transparent Series Mode</i>	5.6ms

vi. LED meaning

<i>LED ON</i>	The modem is powered and has started up
<i>LED SYS</i>	Modem malfunction
<i>LED OUT</i>	Logical state of the output
<i>LED IN</i>	Logical state of the input

vii. Various

<i>Buffer Ethernet</i>	8Ko shared
<i>Flash memory for web pages storage</i>	2Mo
<i>Maximal consumption</i>	150mA (reception) / 400mA (emission)
<i>Casing</i>	Aluminum

2. Installation

a) Warnings

During installation please observe the following instructions:



The power supply of the equipment must be connected to an electrical installation that complies with the standardization in force in the country (NFC 15-100 in France). It must be equipped with protections against overcurrent, over voltages, earth faults (maximum 16A rating).



All equipment connected to the product must conform to EN 60950-1 Ed. 2006 or their product standard.



The power supply of the equipment must have a disconnecting device in accordance with IEC 60947. The disconnecting device must be as close as possible to the power supply and must disconnect all active poles.



Do not install the equipment near a heat source or near a source of moisture.



For your safety, it is imperative that before any technical intervention on the equipment it be turned off and not connected to the mains.



The security provided by this product is only assured for a use that is in accordance with its intended purpose. Use only the recommended power supply TRACO POWER, model TCL24 - 124 or a power supply in accordance with EN60950-1: 2006, limited power.



The security provided by this product is only assured for a use that is in accordance with its intended purpose. Maintenance can only be performed by qualified staff members.



Do not use the radio box directly outdoors, it is not waterproof and is intended to be integrated in a box or in an electrical cabinet (optional on request).



Do not connect the Din Rail bracket to ground so that the radio box is grounded. If an external mast antenna is used, it must also be earthed and possibly added a surge arrester.



Observe the standards using only the cables and antennas recommended, so as not to exceed the effective radiated power (P.A.R.) allowed.

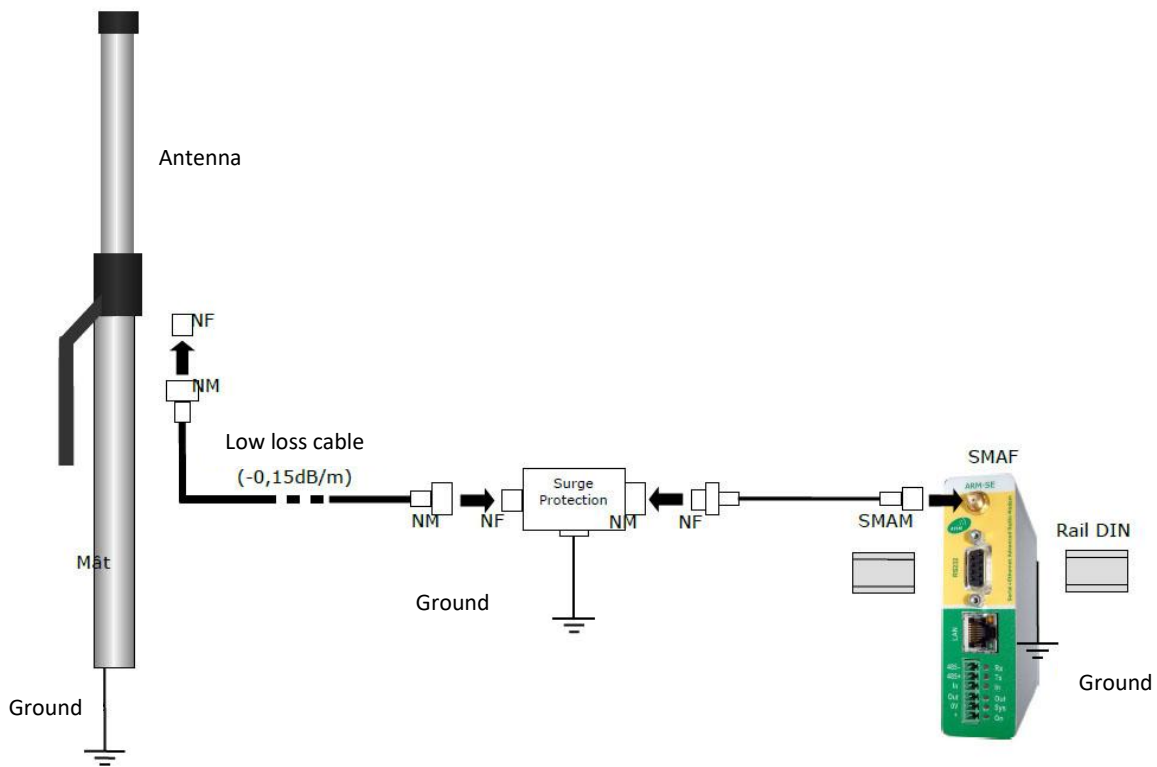







Antenna connection

The use of coaxial cable type RG58 (-1dB / m) is not recommended (high loss).

b) Antenna

A bad choice of antenna can have considerable consequences on the quality of the radio link. It is important to use a suitable antenna and, if necessary, a low loss cable to place it in a slightly obstructed area. The table below shows the antennas available on order:

ANT868-14S3.8		Antenna 1/4 roof wave with 3m80 cable + SMAM plug (Length 0.5, 1 or 3m80)
ANT868-12FSC		Whip Antenna 1/2 SMA angled wave (direct mounting on A.R.M.)
ANT868-12S3.8		Antenna 1/2 roof wave with cable length 3m80 + SMAM plug
ANT868-BZ		Omn-directional antenna "Bazooka" 4.15dBi female N connector for mast mounting (with mounting flange)
ANT868-Y12		Yagi 6-element 11.5 dBi directive antenna, male FME connector (Be careful to respect the standards in force!)
ANT868-Y15		Yagi 10-element 15 dBi directive antenna, male FME connector (Be careful to respect the standards in force!)

c) Mounting

i. On cabinet

A.R.M. radio modems can be supplied with a $\frac{1}{2}$ wave whip antenna angled so that the antenna is positioned vertically directly on the modem.

This antenna is interesting if A.R.M. is mounted in a plastic box. In this case the antenna must not be placed against a metal plate (bottom plate for example). $\frac{1}{2}$ Wave antennas do not require a ground plane and can therefore be mounted directly on a non-metallic surface.

If the radio modem is mounted in a cabinet or metal cabinet, you can use the antenna ANT868-14S, antenna $\frac{1}{4}$ roof wave with its cable and SMA plug.

The antenna should be mounted vertically (up or down, depending on the area to be watered). For best results, it is advisable to place it high and clear of any metallic obstacle in a radius of 1 meter if possible.

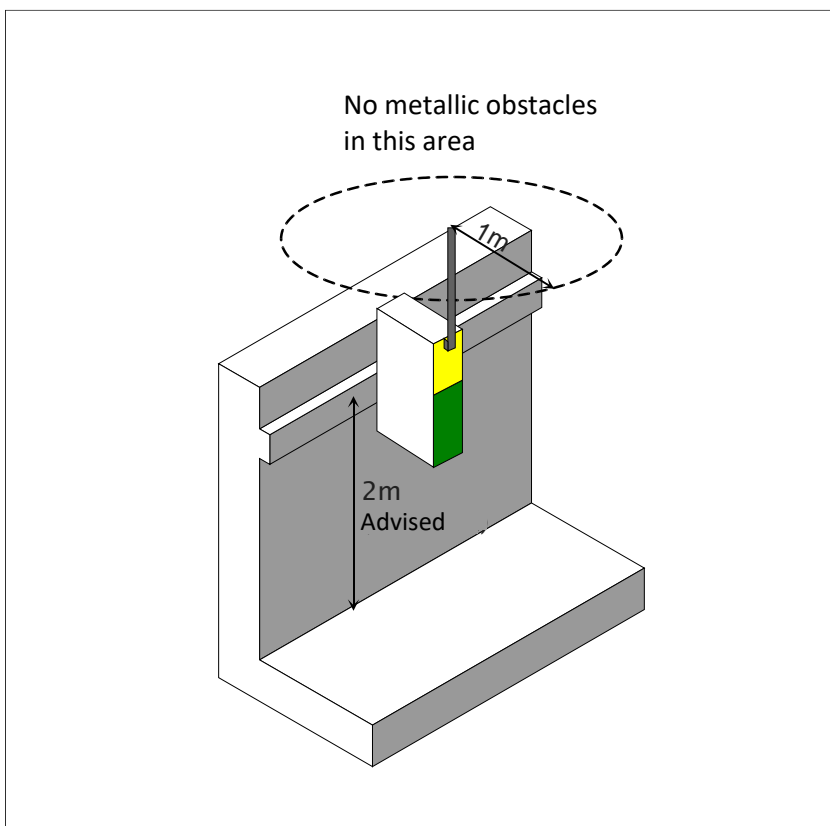

Placement of the modem

ii. Exterior antenna (mast)

In this case, you can use the antenna referenced ANT868-BZ with a cable type CFP10 (low loss diameter 10mm). With this type of cable, you can depart the antenna 10 or 20m or more depending on the link budget (we can calculate it for you to know the distance between the two or more points, the type of antenna and the desired cable length). Do not use any coaxial cable or RG58 which, at this frequency, causes a colossal loss.

The Fresnel zone is a radio propagation zone represented by an ellipse between the 2 antennas. The more we wish to transmit far, the more it will mount antennas (About 1m / km, a height of 5m for 5km), this to avoid any obstacle in this area. In free field and at sight, with antennas installed according to these recommendations, the range of A.R.M radio modems can go up to several km

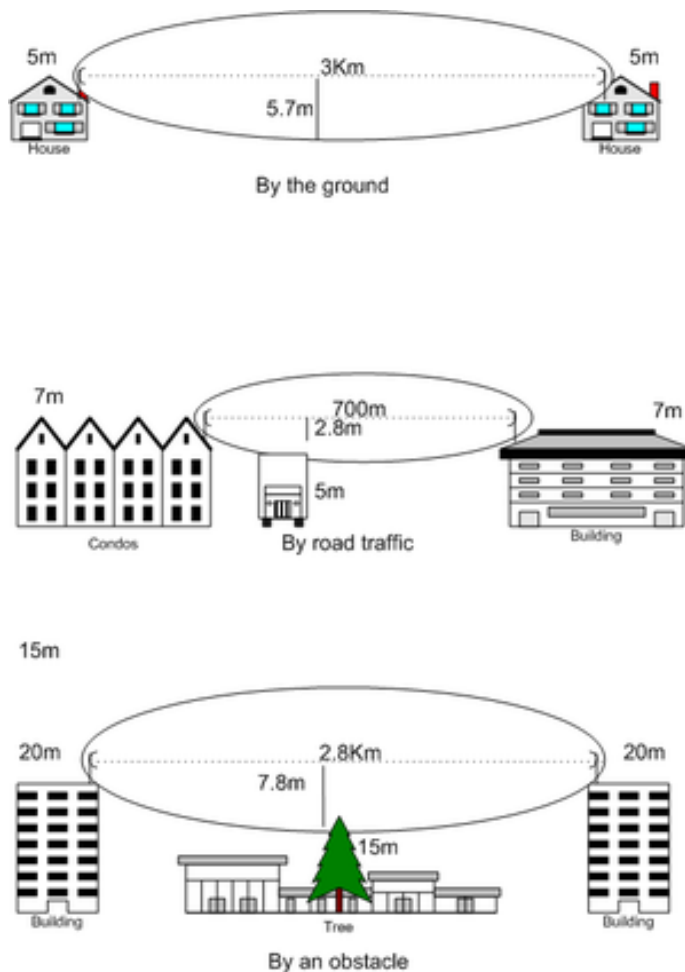

Fresnel zone (Source: Wikipedia)

If D is the distance AB between the antennas, in the center of the link (about the middle of AB), the radius of this ellipsoid is equal to:

$$b = \frac{1}{2} \sqrt{\lambda \cdot D}$$

(Source: Wikipedia)

d) Radiation pattern

« A radiation or emission diagram is the graphical representation of the spatial distribution of a quantity characterizing the radiation of a radio antenna ...

The radiation pattern of an antenna makes it possible to visualize the emission lobes in all three dimensions, in the horizontal plane or in the vertical plane including the largest lobe. The proximity and conductivity of the ground or conductive masses surrounding the antenna can have a significant influence on the radiation pattern. The measurements on the antennas are made in free space or in anechoic chamber. »¹

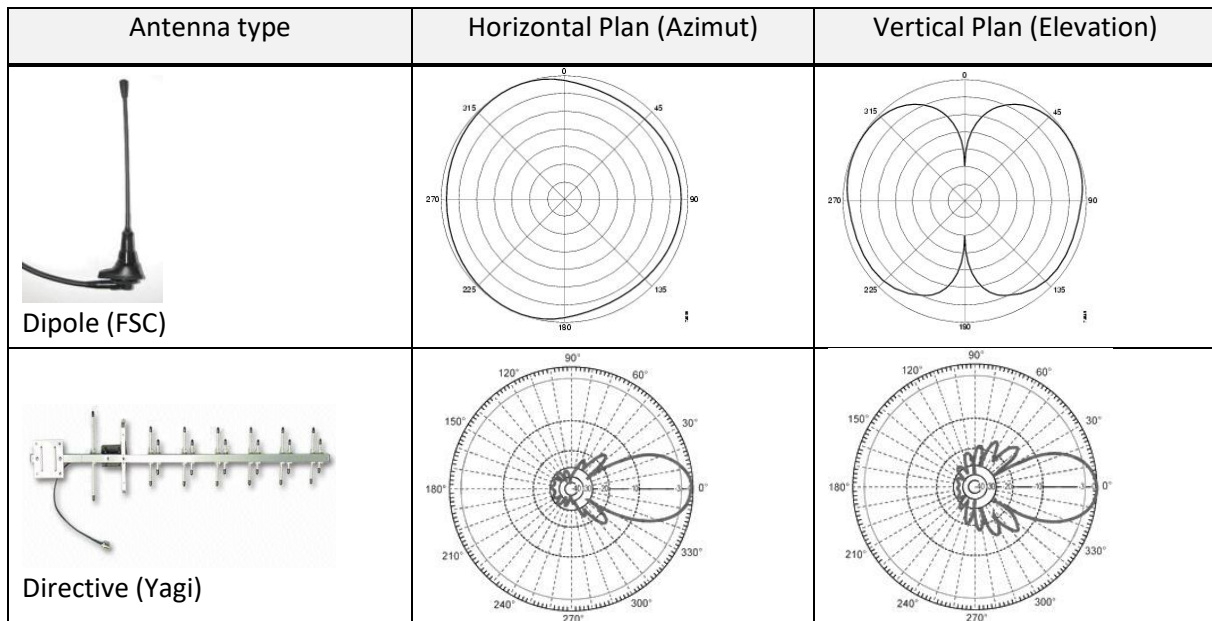

Figure 2 : Different two-dimensional antenna emission diagrams

¹ Source: Wikipedia : https://en.wikipedia.org/wiki/Radiation_pattern

The antennas available in our catalog are characterized and their radiation patterns are known. Refer to the antenna user manuals to get the best out of your equipment.



Vertical radiation

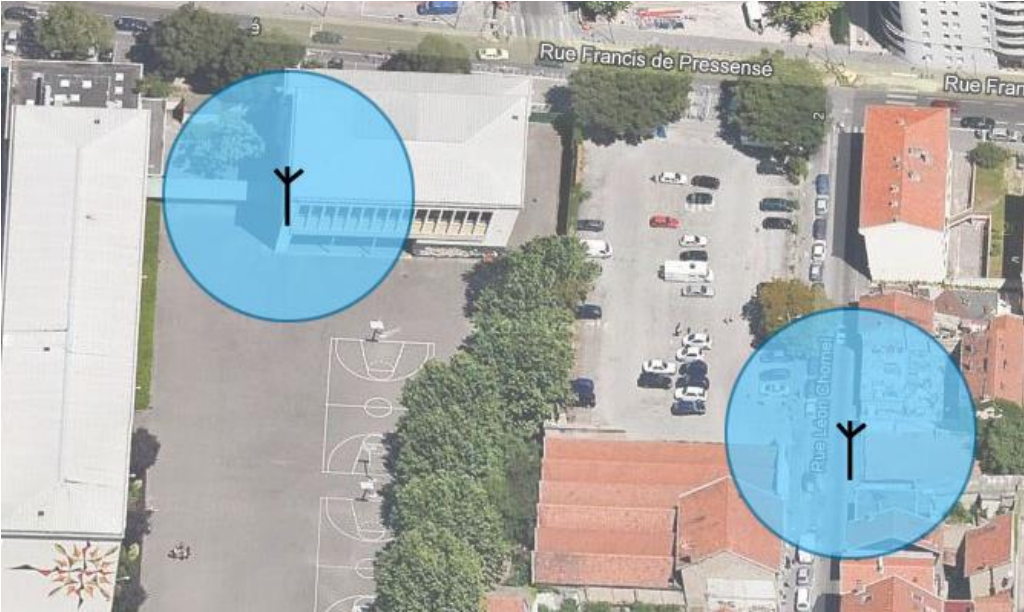

Horizontal radiation

e) Alignment of the antenna

Depending on their radiation pattern and their orientation with respect to the transmitter (or the receiver), the antennas have different performances in terms of radio propagation.

On the ARM-SE modems configuration web pages, it is possible to launch test tools to assess the positioning of the antennas. For this, use the transmitter-side pure transmitter emission tests and the receiver-side spectrum analyzer. The "Spectrum Analyzer" tool allows you to view the received signal level and optimize the positioning of the antennas accordingly.



Tableau 1 : Alignment of Yagi's antennae

f) Radio channel selection

The selection of the radio channel is normally done by the coding wheel placed at the rear of the modem otherwise by software configuration. This is only read when the power is turned on, so you must turn off the power, select the radio channel and switch on again for any change. The encoder wheel has 16 positions from 0 to F (hexadecimal), each corresponding to a different carrier frequency, spaced in steps of 50kHz and variable power.

In compliance with the standard, the information coming from the user must respect an imposed duty cycle or stick to the Listen Before Talk (LBT) protocol. These specificities are configurable by Web pages. Depending on the radio channel chosen, ARM modems can operate over distances of several km.

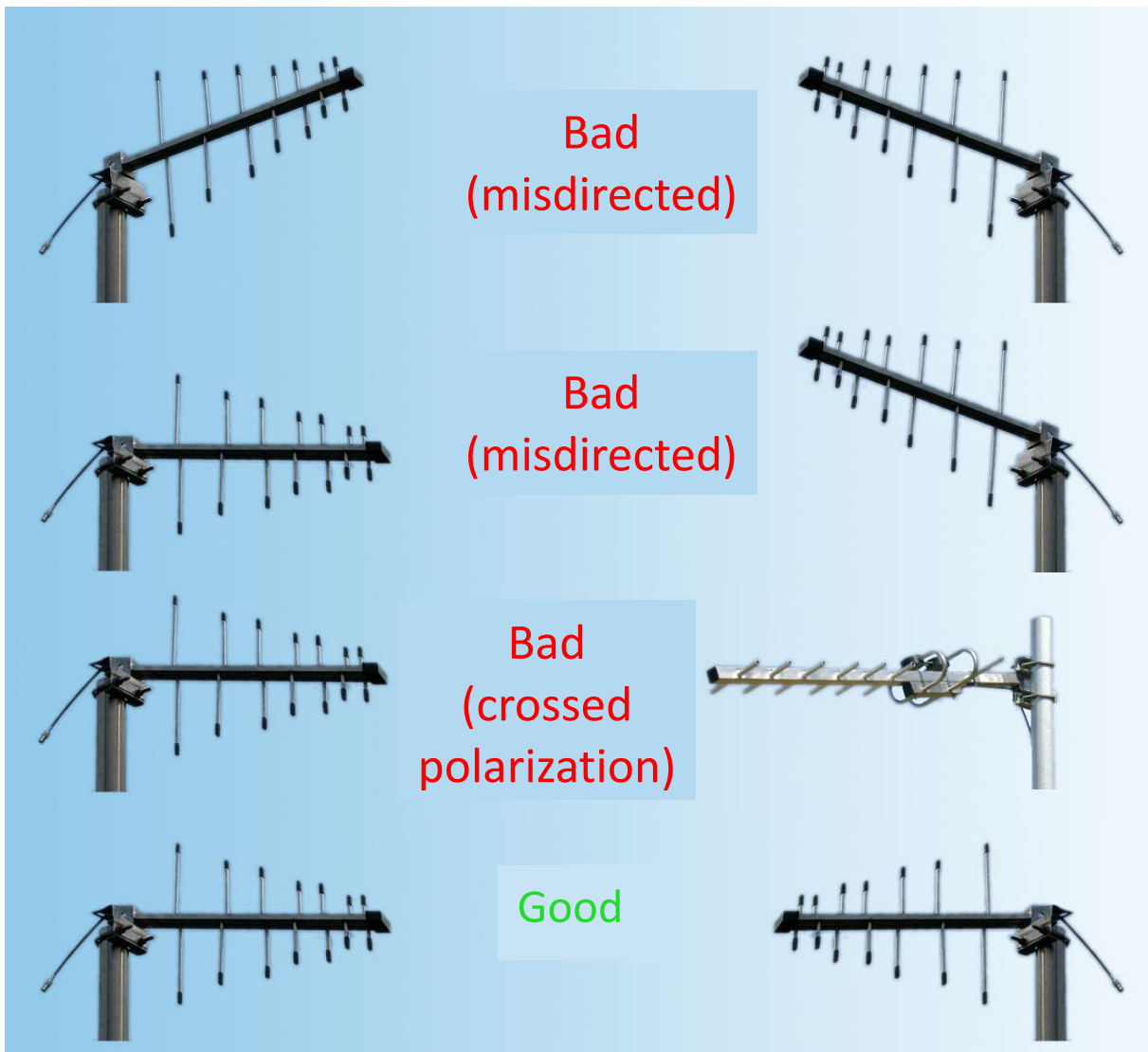
Channel	Frequency (MHz)	Normalized power	Duty Cycle	Reach
0	869,8	5mW	100%	<1km
1	868,075	25mW	1%	<2km
2	868,125			
3	868,175			
4	868,225			
5	868,275			
6	868,325			
7	868,375			
8	868,425			
9	868,475			
A (10)	868,525			
B (11)	869,85	5mW	100%	<1km
C (12)	869,9	500mW	10%	~5km
D (13)	869,475			
E (14)	869,525			
F (15)	869,575			

Characteristics per radio channel for compatible rates

Refer to the FREQUENCY TABLE chapter for a complete list of frequencies.

To communicate ARM modules together, you must assign them the same channel number.

3. Connections and links

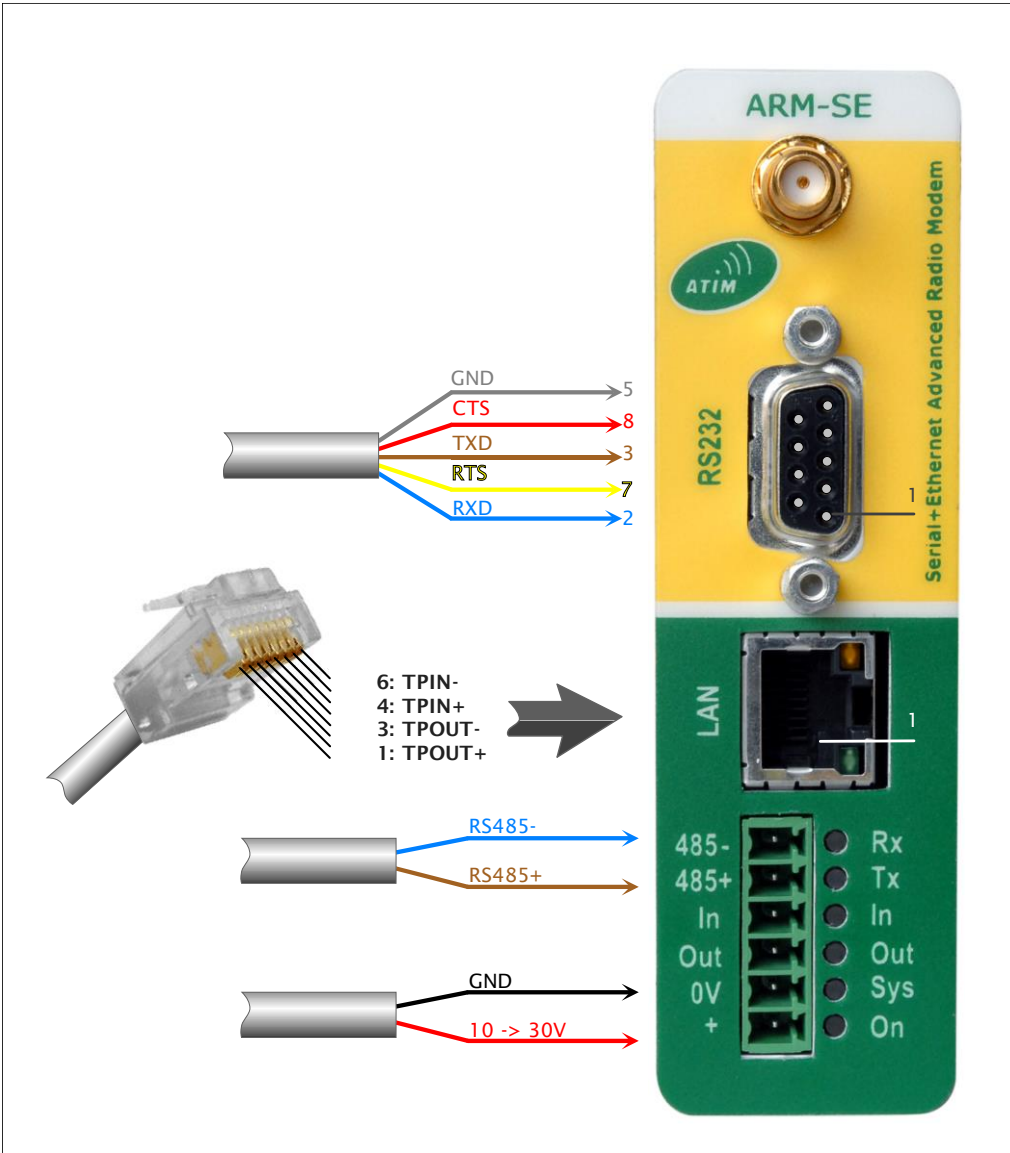

Diagram of connection of the modem

a) Power supply

We recommend the use of our 24V reference ATIM power supply: ALIM220-24V-1A.

The power supply must be near the radio modem.

The cable for the power supply must be 3 conductors of section 0.5 (blue, brown, green / yellow) and maximum length 3m.

The power cable for the ARM radio modem must be 2 conductors of section 0.5 (black and red color) and maximum length 3m.

Connect your power supply between the 0V and + terminals of the removable terminal block.

This must be between 10 and 30V and rectified, filtered. Beware of 220V power supplies that are often of poor quality and can deliver peaks below 10V! The 0V (negative pole) is connected to the housing and thus to the ground via the DIN rail.

The consumption under 12V is:

- About 120mA in reception mode
- About 200mA in emission mode to 10mW
- About 400mA in emission mode to 500mW

b) Installation instructions

- This power supply is designed for professional indoor systems. During operation the power supply must be inaccessible. It can only be installed and put into operation by qualified personnel.
- Does not work without PE connection! In order to comply with the safety instructions and EMC (CE mark, certifications), the power supply can only be put into operation if the PE terminal is connected to the non-integrated earth conductor.
- The correct mounting position for optimum cooling must be observed. Do not cover the ventilation holes. A space of at least 50 mm above and below the unit must be left in order not to hinder natural convection. Watch for power reduction.
- The internal fuse is not accessible. As such it can not be replaced by the user. If the internal fuse blows, the power supply has an internal fault and for safety reasons must be transferred to the local distributor. In the event that the internal fuse needs to be replaced in the field, replace it with a fuse of the same type and power for continuous protection against any risk of fire.
- Recycling: The unit contains items that are designed for recycling, and components that require a special deposit. You are therefore requested to ensure that the device will be recycled at the end of its commissioning.

c) Ethernet link

The ARM-SE modem must be connected to the network by CAT3 or CAT5 cross-over or cross-over cable in accordance with the network device to which it is connected. When switching on, the Orange LED on the RJ45 connector should light up. If this is not the case, check the conformity of the Ethernet cable.

d) Serial link RS232

It is possible to configure the radio modem and also to be able to communicate through this interface.

Be careful

Since the interface is of the DCE type, a 9-pin straight male / female cable must be used for connection to a PC. By default, the selection of the RS485 or RS232 interface is done automatically but it is necessary to use a 9-point cable (Requires at least the 5 signals Tx, Rx, Gnd, Rts, Cts). It is also possible to force the RS232 or RS485 mode (see register configuration). The RS232 cable must be shielded, we recommend a maximum length of 3m, otherwise use the RS485 and a converter.

1			Non used
2	TXD	Output	Data transmission / Host reception
3	RXD	Input	Data reception / Host transmission
4	DSR	Input	Radio and serial communication authorization
5	GND	-	Ground
6	DTR	Output	Shows the state of the radio modem
7	CTS	Input	Request to send
8	RTS	Output	Clear to send
9			Non used

Pinout of the 9-pin SUBD

Use CTS RTS in moshielded, re-saturated (Bit0 of register S27)

RTS: If Active (level 1 RS232) No permission to transmit serial link information

CTS: Active (RS232 Level 1) Indicates saturation of modem memory

Must be used if the speed of the serial link is higher than the radio speed

Use CTS RTS in radio mode (Bit2 of register S10)

RTS: If Active (level 1 RS232) Confirm radio reception

CTS: Inactive (level 0 RS232) Signal receiving radio data

Use of DTR and DSR signals

They allow the communication status of the modem to be controlled only in the transparent mode. The DSR signal signals if the modem is active. The DTR input immediately stops the radio communication and the communication on the serial link (active in state 1 RS232).

Validation of this function by bit 1 of register S10.

e) Serial link RS485

It is possible to configure the radio modem and also to be able to communicate through this interface. The advantage of the RS485 is to be able to put several devices on the same 2-wire bus (A, B or respectively + and -). This bus is widely used in industrial applications because it is not very sensitive to external disturbances (differential link).

Disable ↔ Enable (down position)	
4: Termination 120Ω	
3: Pull-down 2.7K	
2: Pull-up 2.7K	
1: Test mode	

Termination resistor and polarization on RS485

Be careful

By default, the selection of the RS485 or RS232 interface is done automatically but this requires that nothing is connected to the RS232 (SUBD disconnected). However, it is preferable to set the RS232 or RS485 mode (see S16 register).

The RS485 bus requires a terminating resistor of 120 Ohms on each of the two RS485 devices located at the end of the line (in the case of a long line or in a disturbed environment). If the cable between your equipment and the ARM is short and undisturbed, it is best not to put the terminating resistor in order to decrease the power dissipated. It is also necessary that the line is polarized on at least one of the equipment connected to the bus.

To activate or deactivate the termination resistor and Pull-up, Pull-down resistors, the dipswitches on the back of the modem must be activated.

f) Dry contacts

The ARM-SE is equipped as standard with an input (IN) and a logic output (OUT). It can be controlled by Modbus function.

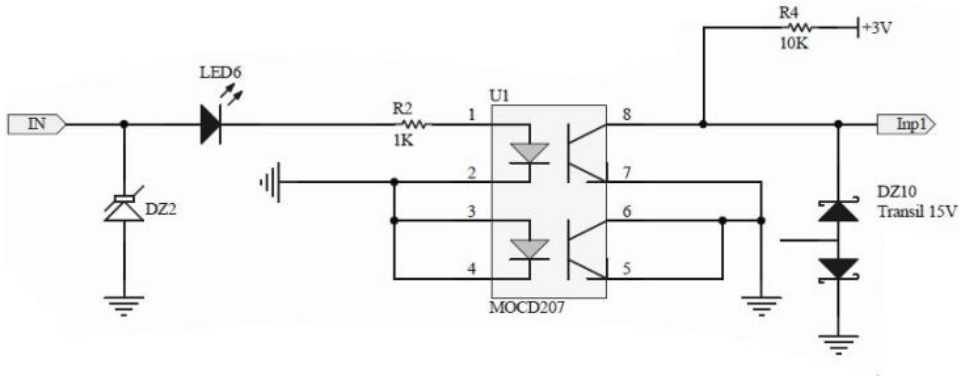

Logical input

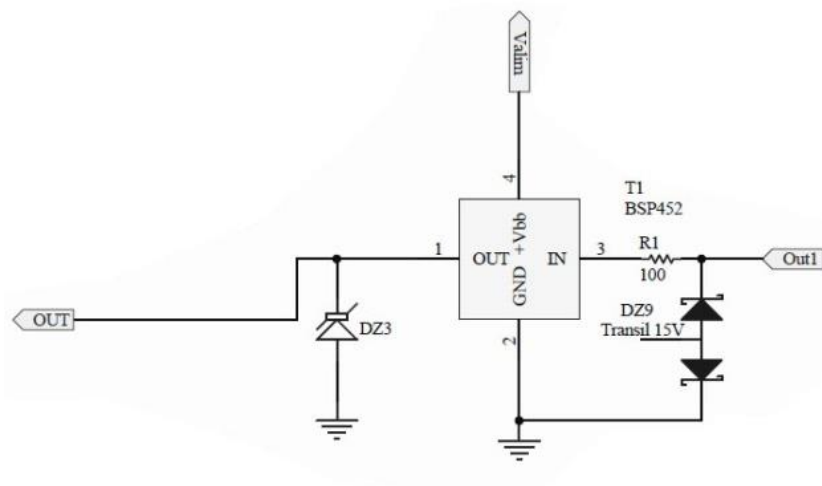

Logical output

4. Configuration

The modem has a basic (or so-called "factory") configuration in its program memory. This configuration is copied to the backup memory which can be changed according to the configurations made by the user. These changes are possible by internal web pages.

The parameters thus configured only take effect after validation and restart of the modem. From the Web pages, validate the modifications by clicking on "Apply" then quit the application by clicking on "Exit and Save" to restart the modem.

a) Configuration by embedded web pages

To access the modem configuration, the IP addresses of the modem and the PC must belong to the same class. Originally, the address class of the ARM-SE is **192.168.0**; the station wanting to access its configuration must therefore have a similar address class.

If this is not the case, these settings can be configured from the Windows Control Panel, **Network Connections category > Local Area Connection > General tab > Properties > General tab > Internet Protocol (TCP / IP) > Properties > IP address**.

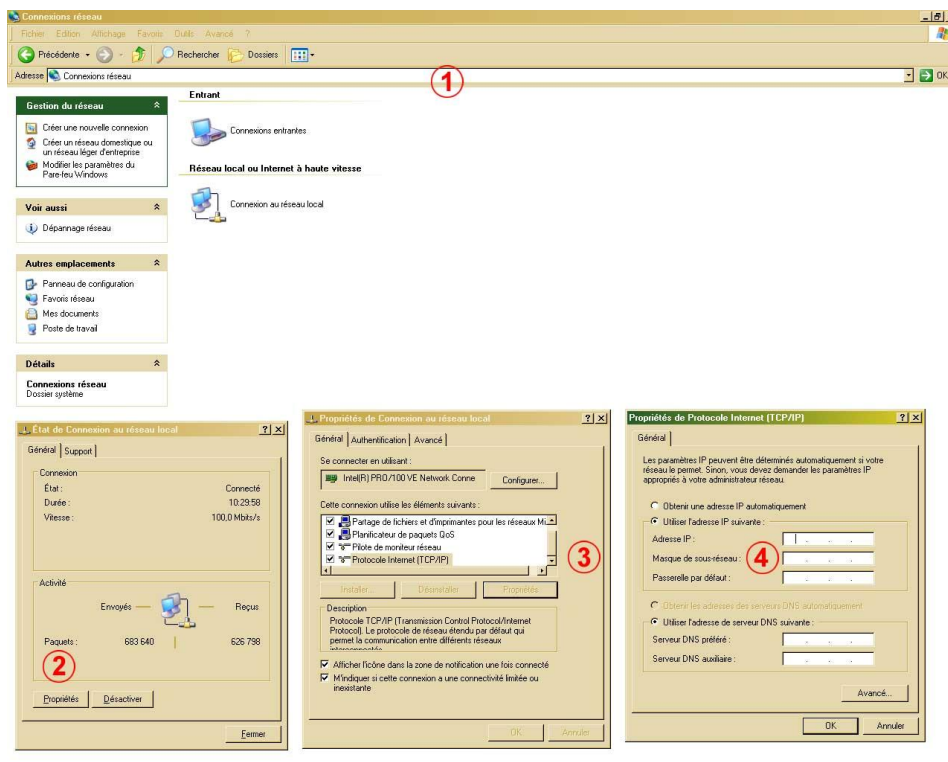

Illustration 8: Configuration of TCP-IP Settings

Note

Beware of PCs with Wi-Fi controllers that can redirect Ethernet traffic on their media. It may be possible to disable this type of controller.

Web pages using port 80, this port is normally released, by default, by the firewall.

The advantage of an embedded configuration software is that it does not require any installation. However, for browsers too old or other than Internet Explorer, Mozilla, Opera, Chrome, Safari, compatibility issues may appear.

b) Homepage and password

@IP of the ARM-SE by default: 192.168.0.25
Password: *default*

The modem must be connected to a PC via an Ethernet cable in accordance with its network connection (straight or crossed). From an Internet browser, access the modem home page at **192.168.0.25**. The default password is « **default** » which can be changed to the "Admin" tab.

The screenshot shows the 'Change Password' form. It has a yellow background and a green header with navigation tabs: Setup, Serial Port, Radio, Alerts, I/O Module, and Administration. The form contains three input fields: 'Current Password', 'New Password', and 'Re-type New Password'.

Setting a new password

The screenshot shows the 'ARM-SE 2 SETUP' page. It has a green header with the ATIM logo and the title 'Advanced Radio Modem - SERIAL ETHERNET - Version 2'. The page is divided into several sections: 'Local Modem' with fields for Local IP Address (192.168.0.25), Subnet Mask (255.255.255.0), DNS Server address (192.168.0.1), Gateway Address (192.168.0.1), and Local MAC Address (00-04-A3-D7-36-45); 'Operating Mode' with a dropdown menu showing 'Serial' selected; and 'Serial Mode' with a dropdown menu showing 'Serial' selected. There is a red message: 'Check RS port and manage Radio settings to improve performance'. At the bottom, there are 'Apply', 'Cancel', and 'Exit and Save' buttons.

Choice of operating mode

On the home page (« Setup » tab) in front of « Operating Mode » is a list of operating modes that determine the source of information transmitted by radio. The various parameters that can be configured follow, guiding the user to modify the useful parameters adapted to his situation. The following chapters deal with modem setup in a comprehensive way.

5. Operating mode

a) Serie

This mode of operation makes it possible to deport the information of a serial link RS232 or RS485 by radio.

The interconnection of serial information and radio information is via buffer. Their size is:

- Serial Buffer Tx: 256 octets
- Serial Buffer Rx: 512 octets

The reception buffer is capable of storing the start and the end of each finalized frame at the end of the data transfer on UART (after dead time (T_f) of 3 x time byte at the UART rate used).

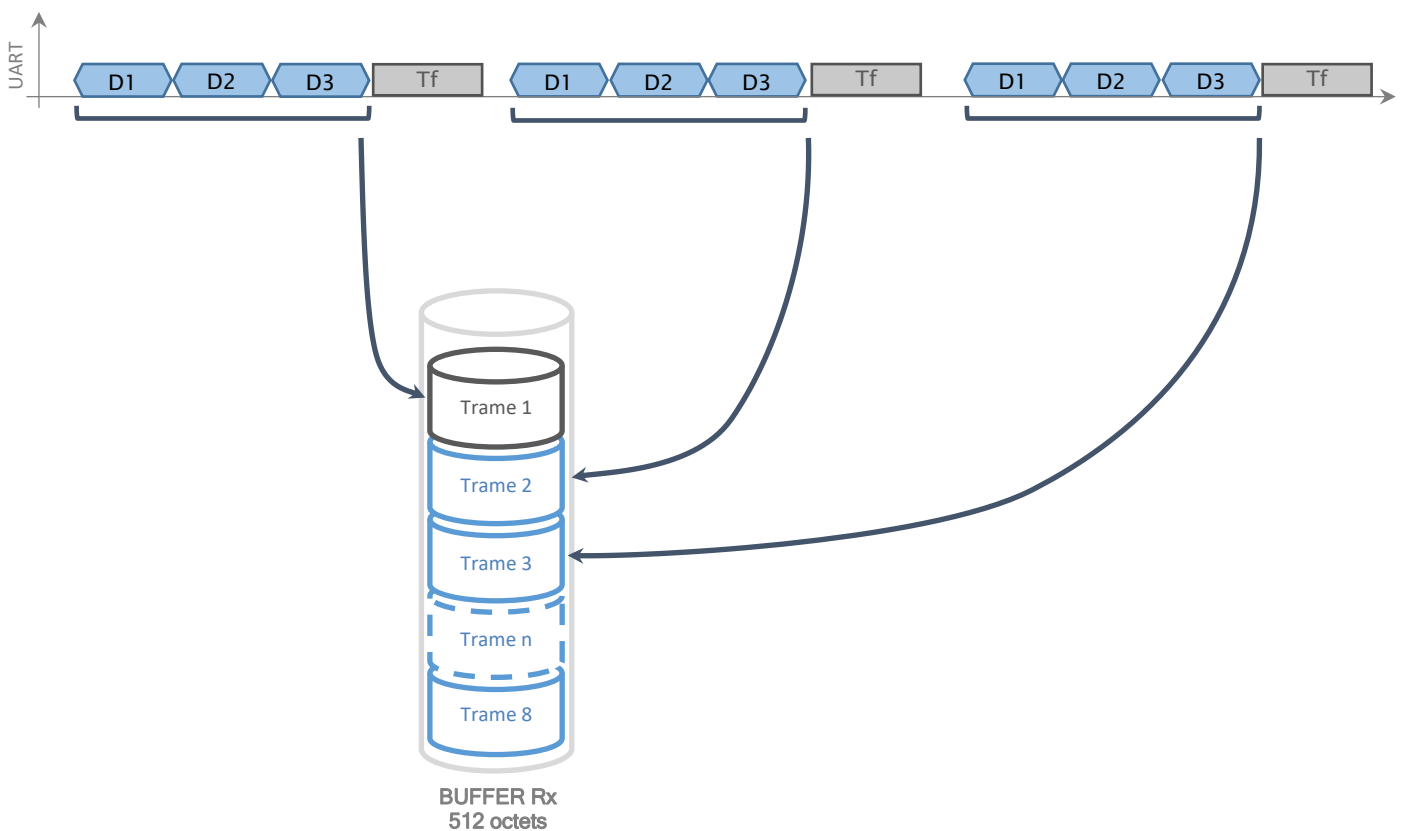

Data reception on Rx-UART

This mechanism makes it possible to reproduce the stream of frames on the remote modem by successive radio transmissions.

The flow of information on the radio depends on the configuration parameters of the radio part. In packet mode, incoming frames in the serial buffer are split into packets of 120 bytes. This configuration can cause holes in the communication. To overcome this phenomenon, the Stream mode emits the data as they arrive in the serial buffer. The serial input and radio output rates must then be very close in order to avoid any end-to-end congestion of the communication.

i. Setup

	Setup	RS Port	Radio	Alerts	I/O Module	DataLogging
Local Modem	Local IP Address	192	168	0	25	
	Subnet Mask	255	255	255	0	
	DNS Server address	192	168	0	1	
	Gateway Address	192	168	0	1	
	Local MAC Address	00-04-A3-D7-36-45				
Operating Mode		Serial				
Serial Mode	Mode	Transparent				

Check RS port and manage Radio settings to improve performance

On the Setup tab

Choose the *Serial* operating mode

Validate changes by *Apply*

Setup	RS Port	Radio	Alerts	I/O Module	DataLogging
RADIO CONFIG					
Radio Channel	<input type="radio"/> Tx/Rx Channel by Coding wheel <input checked="" type="radio"/> Tx/Rx Channel by Software 522 dec(1 - 559) <input checked="" type="checkbox"/> Listen before talk				
Data formatting	Stream Mode (infinite packet) <input type="radio"/> Zero Latency <input type="checkbox"/> Packet Mode (120bytes packet) <input checked="" type="radio"/>				
Modulation	Radio Baudrate 19200 bps Max Power level Auto				
Radio Addresses	Sender address 00 (0x00 - 0xFF, 0x00 for broadcast) Recipient address FF (0x00 - 0xFF, 0xFF for broadcast)				
Wake On Radio	Enable <input type="checkbox"/> Long Preamble <input type="checkbox"/> Preamble length 0 (0 - 2000 ms) Post WOR Window 20 (0 - 2550 ms)				
<input type="button" value="Apply"/> <input type="button" value="Cancel"/>					
<input type="button" value="Exit and Save"/>					

On the *Radio* tab

- Choose the same channel as the remote modem (s).
- Choose Packet or Stream mode
- Choose the same radio rate as the remote modem (s).
- Basically, it is not necessary to configure the radio addressing.
- Do not activate the Wake On Radio mode.
- Validate changes by *Apply*

b) Repeater

i. Synoptic

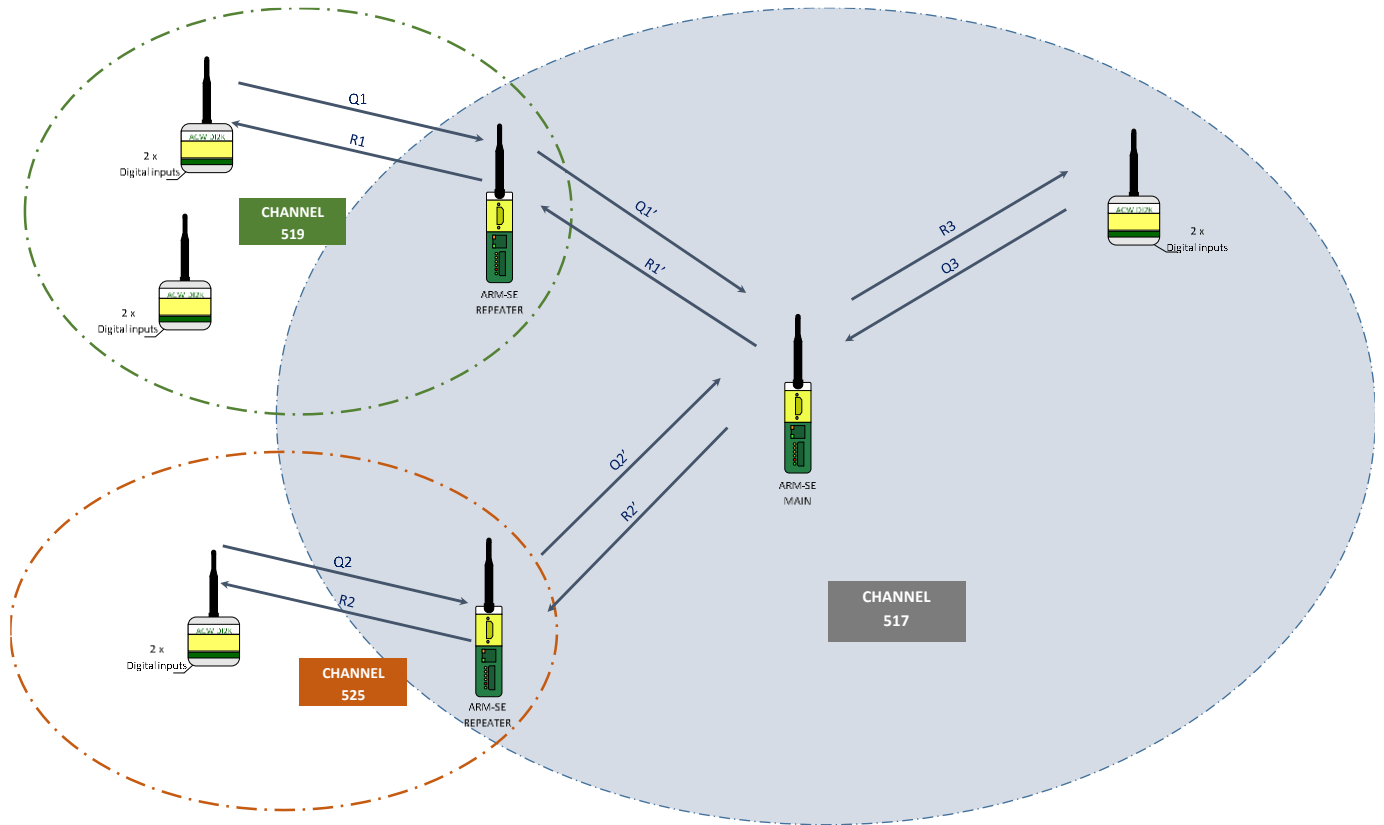

The repeater mode of the ARM-SE permanently switches to receive one radio channel. Any message received on one radio channel is broadcast on another radio channel.

ii. Filtering

This mode of operation, relatively simple, also introduces a notion of filtering radio messages that obeys the following rule:



Rule of filtering (in reception) of the message sent by modem A and received by modem B:
 Message ok = [(EXP_A ≠ EXP_B) **OR** (EXP_A == 0x00)] **AND** [(DEST_A == EXP_B) **OR** (DEST_A == 0xFF)]

For the repeater modem:

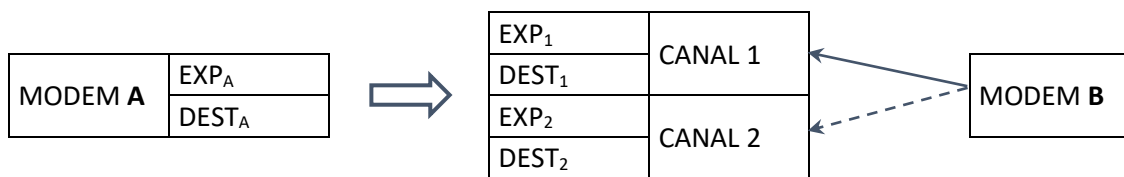

Filtering rules are essential in the case of several repeaters within the same radio coverage area (in order to avoid a repetition loop between repeaters). On the other hand, when a single repeater is used, it is possible to use a basic filtering rule of the type:

Message ok = [(EXP_A == 0x00)] **AND** [(DEST_A == 0xFF)]

By default, the basic filter rule is applied.

iii. Limitations

The ARM-SE limits the size of repeated frames to 120 bytes. Only the packet mode is compatible with the repeater (see Radio tab> Data Formatting> Packet Mode).

Using this mode induces longer communication times than in direct mode.

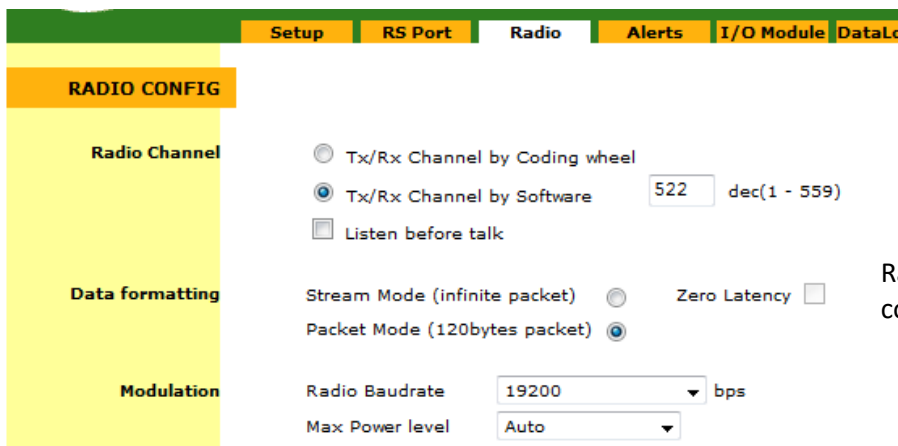

Radio configuration of repeater compatible modems

iv. Setup

Setup	RS Port	Radio	Alerts	I/O Module	DataL
Local Modem					
Local IP Address	192 . 168 . 0 . 25				
Subnet Mask	255 . 255 . 255 . 0				
DNS Server address	192 . 168 . 0 . 1				
Gateway Address	192 . 168 . 0 . 1				
Local MAC Address	00-04-A3-D7-36-45				
Operating Mode					
	Repeater				
Repeater Config					
Radio settings					
Primary channel	522 (1 - 559)				
Sender address	00 (0x00 - 0xFF)				
Recipient address	FF (0x00 - 0xFF)				
Secondary channel	522 (1 - 559)				
Sender address	00 (0x00 - 0xFF)				
Recipient address	FF (0x00 - 0xFF)				
Serial settings					
Forward to serial port	<input type="checkbox"/>				
<input type="button" value="Apply"/> <input type="button" value="Cancel"/>					
<input type="button" value="Exit and Save"/>					

Choose Repeater as the main mode of operation.

Primary channel
Primary filters

Secondary channel
Secondary filters

Return received frames to the serial port

Validate changes by *Apply*

c) Gateway Modbus

The ARM-SE manages the ModBus protocol on several types of media:

- Ethernet link (TCP port)
- RS485 or RS232 serial link
- Radio link

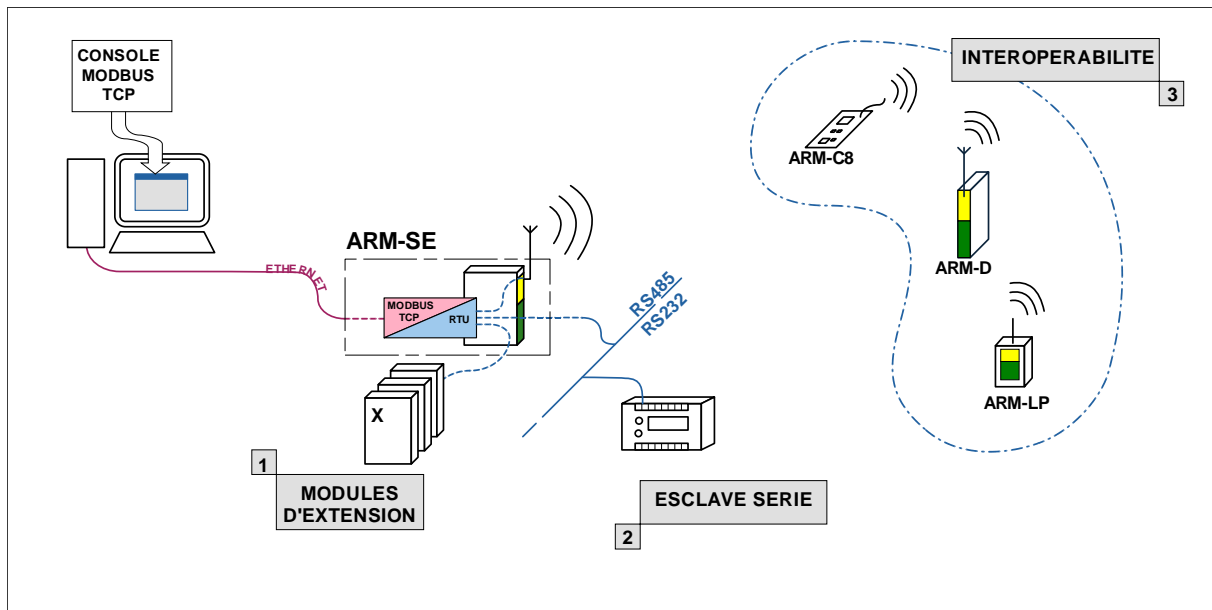

In order to make these modes of communication compatible with each other from an Ethernet connection, the ARM-SE integrates a ModBus TCP / ModBus RTU gateway. The ARM-SE is then seen as a server queried by a client ModBus TCP application. To preserve maximum memory and performance, the user is asked to specify the number of client applications that connect to the ModBus TCP server.

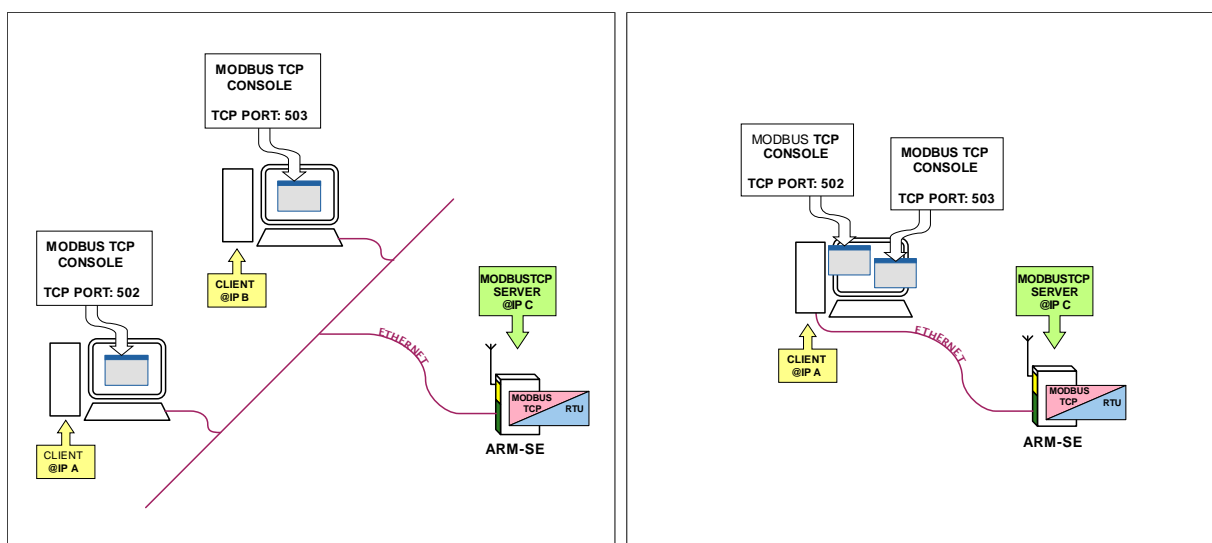

The purpose of the server (gateway) is to decapsulate the ModBus RTU message contained in a ModBusTCP Ethernet frame. Once unencapsulated, the ModBus RTU message is sent to different possible targets (target 1, 2, or 3 in the figure above).

The TCP port used on the ModBus client side must match the server-side TCP port (default port 502). This port makes it possible to reach the desired target (local (1), on serial link (2), over radio link (3)). Clients or client applications that query the ModBusTCP server are reduced to a maximum of two and must borrow a different TCP port (which does not exclude multiple ModBusRTU slaves being polled by the same TCP port).

If the target does not respond within a pre-defined timeout, the server throws a ModBus exception.

i. Local target

If the modem is accompanied by expansion modules, it is possible to query the status of their inputs / outputs or to consult a list of internal registers specific to the modem (counters, variables, states of IN and OUT etc.) from the ModBus console.

ii. Serial link target

In this mode, the target is connected to the serial link of the modem. It is then necessary to specify the type of connection (RS485 - RS232 and their parameters) from the « Serial Port » tab of the Web pages.

Note

Only one serial link configuration can be used (the same for all clients).

iii. Target on remote radio modem

This mode makes compatible the different modems of the ARM range with the ARM-SE. If the mode of operation of these is Modbus Slave, it is possible to interrogate them remotely and thus access all their features.

Note

Only one radio link configuration can be used (the same for all clients).

iv. Settings

	Setup	RS Port	Radio	Alerts	I/O Module
Local Modem	Local IP Address	192 . 168 . 0 . 25			Operating Mode: Gateway Modbus
	Subnet Mask	255 . 255 . 255 . 0			
	DNS Server address	192 . 168 . 0 . 1			
	Gateway Address	192 . 168 . 0 . 1			
	Local MAC Address	00-04-A3-D7-36-45			Modbus modem slave identifier
Operating Mode	Gateway Modbus ▼				
ModBusRTU					
Modbus Id	Slave identifier	1 (0 - 254)			The Ethernet controller of the ARM-SE can apply some filters to avoid possible congestion of its buffer
ModBusTCP Server					
LAN Filters	IP Broadcast Allowed	<input checked="" type="checkbox"/>			
	MAC Filters	<input checked="" type="radio"/> Promiscuous (No Filter) <input type="radio"/> Destination white list			
Targets	Port 1 type	TCP ▼			
	Client 1	TCP PORT:	502		
	Target:	<input checked="" type="checkbox"/> Local <input type="checkbox"/> Over Serial <input checked="" type="checkbox"/> Over Radio			
	Timeout:	250 (0-65535ms)			
	Port 2 type	RS ▼			
RS Port	Target:	<input checked="" type="checkbox"/> Local <input checked="" type="checkbox"/> Over Radio			
	Timeout:	250 (0-65535ms)			



Apply Cancel

Exit and Save

Validate changes by *Apply*

ModBus Exception

Exceptions are returned by the server to the client when the request did not reach its target or when the target did not respond before a certain timeout. The ModBus TCP server on the ARM-SE as well as the ModBus RTU targets emit various types of exceptions to identify the source of the problem.

Exception	Type	Description	Solution
SERVER FAILURE	4	Due to bandwidth that is too high, the server is unable to unencapsulate the message.	Reduce the number of requests or clients and manage Ethernet traffic.
ACKNOWLEDGE REQUEST	5	The message is unencapsulated, but the target requests a response time to process the message.	Use another radio channel (because waiting for release) or increase the maximum response time of the target.
SERVER BUSY	6	The server is busy.	Exit the web-based modem configuration (Exit and Save).
GATEWAY TARGET FAILED	11	The target does not answer.	Check the settings of the target, the ModBus TCP server and the ModBus TCP client.

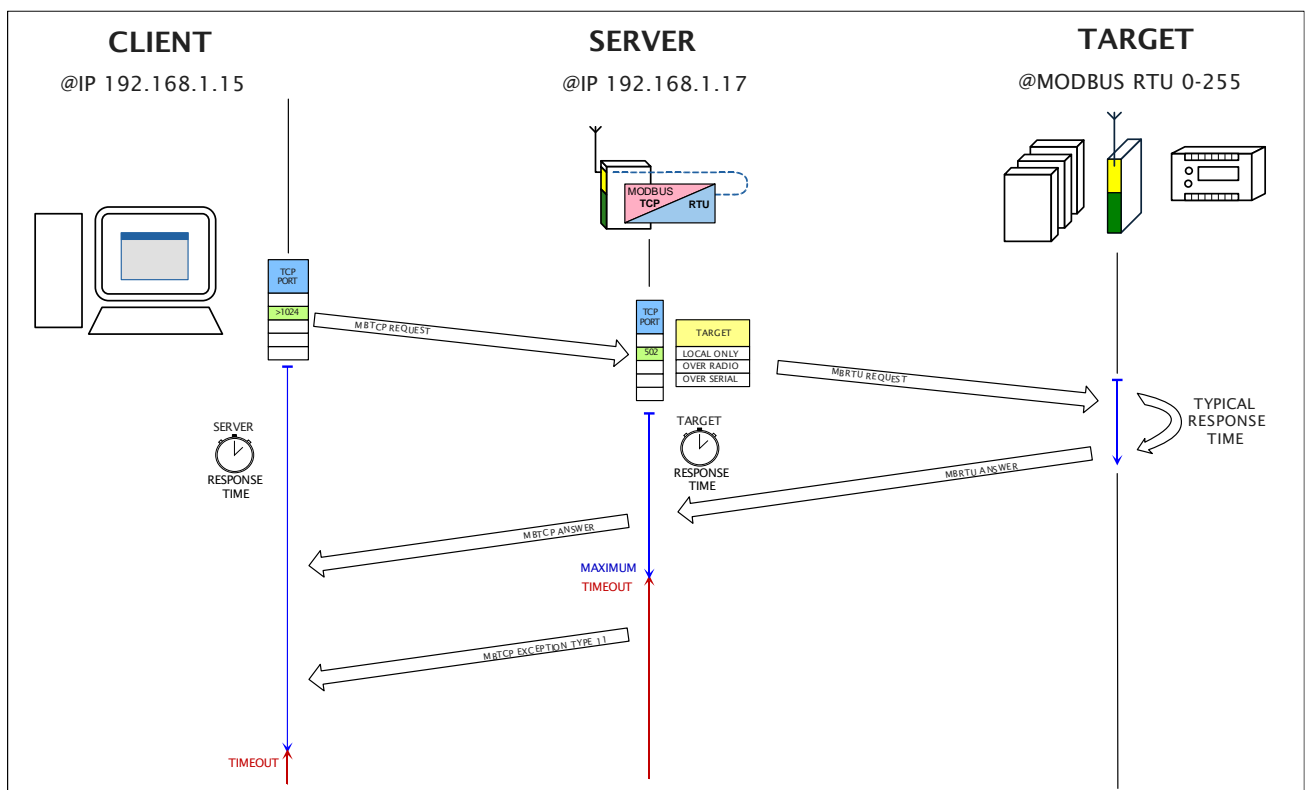

6. Firmware update

In order to keep the ARM-SE firmware up to date, the modems include a "BootLoader" program that allows you to reinstall the main program. This reinstallation is done via the modem's Ethernet connection using the ENC_loader utility provided with the update package. Allow outgoing connections to your Firewall or disable it.

To do this, be sure to follow these steps:

1. Set the encoder wheel on the back of the modem to B and lower the DIP Switch 1 located lower.
2. Power the modem. After a few seconds the Power LED flashes.
3. Launch the « LIA Loader Utility » application

Note

In this mode the computer and the modem do not need to belong to the same class of IP address. The IP address of the modem is called Multicast.

1. Click on "Locate LIA". The first step (*LIA Status: 0408*) of the Error! Source of the return not found. indicates that the modem is located.
2. In the drop-down list, under « Configure LIA », check that « LIA ID » matches the previously located target.
3. Click on "Capture Target". The second step (*LIA Status: 4408*) of Error! Source of the return not found. indicates that the target is captured, and the modem's Rx LED is illuminated.

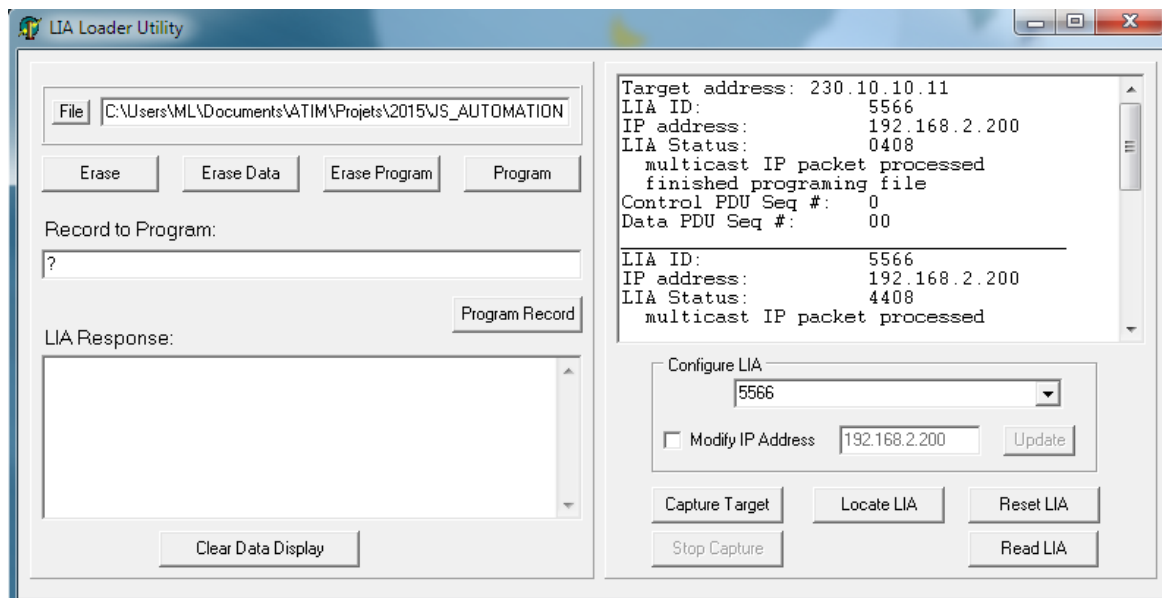

4. Click on « File » and open the .HEX file.
5. Click on « Program ». The .hex file is downloaded to the modem and the Rx LED flashes.
6. The download ends and the modem sends the message « Programming Complete ».

7. De-validate the conditions of step 1 and restart the modem by clicking on "Reset LIA".

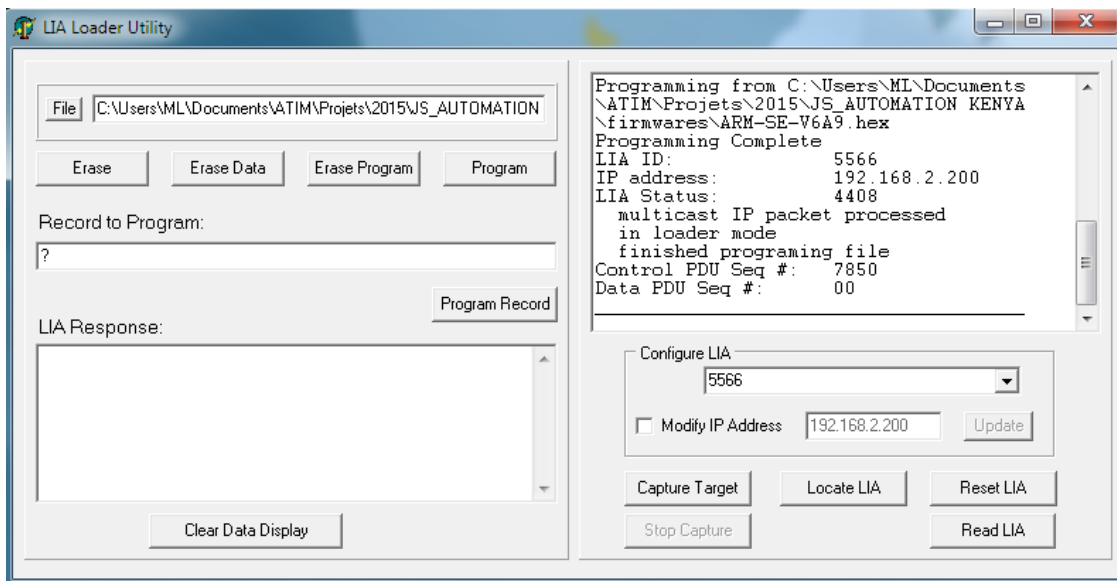

Remark

When a modem is updated, it automatically returns to the factory configuration. It is then necessary to re-parameterize it.

7. Update of embedded web pages

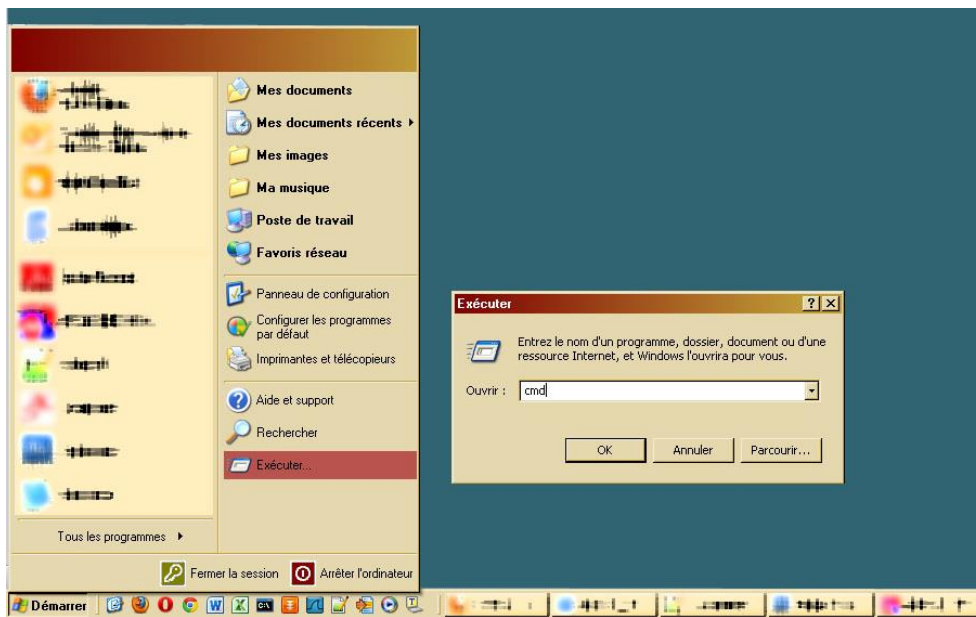

Launching MS-DOS Commands on Windows XP

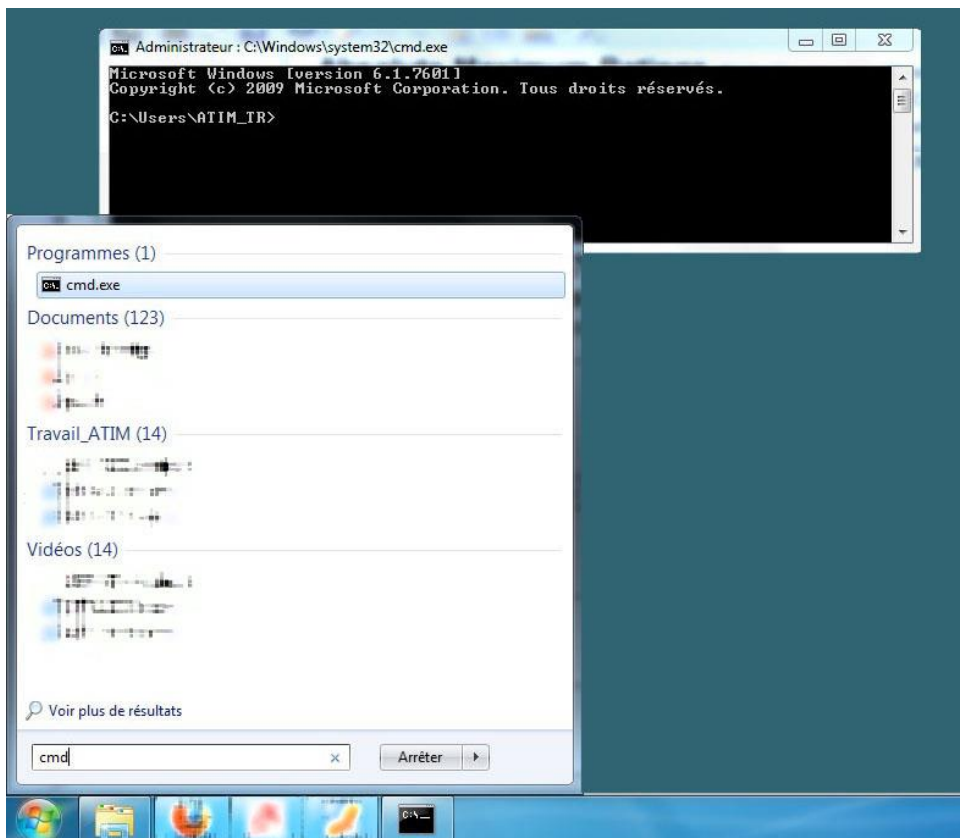

Launching MS-DOS commands under Windows 7

8. Save parameters and return to factory settings

It is possible to save the settings as a test file.

The screenshot displays the ATIM ARM-SE 2 SETUP web interface. The top navigation bar includes tabs for Setup, RS Port, Radio, Alerts, I/O Module, DataLogging, and Admin. The 'Settings Backup' section contains the following options:

- Change Password: Fields for Current Password, New Password, and Re-type New Password, with an Apply button.
- Factory Settings Backup: An Apply button.
- Save Settings: A Download Config button.

A file download dialog box titled 'Ouverture de armse.cfg' is overlaid on the right side. It shows the file 'armse.cfg' (type: cfg File) from 'http://192.168.0.20'. The dialog asks 'Que doit faire Firefox avec ce fichier ?' and has three options: 'Ouvrir avec' (selected), 'FlashGot', and 'Enregistrer le fichier'. The 'Enregistrer le fichier' option is selected. There are 'OK' and 'Annuler' buttons at the bottom.

The 'ADVANCED' section at the bottom includes 'AT Commands (ex S40: type 40)' with fields for 'Register Address' and 'Register S =', and buttons for 'Read', 'Write', and 'Exit and Save'. The footer reads '- ATIM Radiocommunications - www.atim.com -'.

1. Open the configuration by web pages
2. Go to the Admin tab
3. Click on "Download config" and agree to save the file
4. To return to the factory settings: click Apply in front of Factory Settings BackUp
5. Open an MS-DOS command prompt and move to the text file directory
6. Type 'ftp 192.168.0.20'
 - a. modem reply "Connected to 192.168.0.20" "220 Ready"
7. Use 'ftp' as login (<192.168.0.20: <none >>: ftp)
 - a. modem reply "220 Logged in"
8. Type 'put armse.cfg' and wait for the end of the process

9. Radio frequency table

Channel		Freq.	1,2 kbps	2,4 kbps	4,8 kbps	9,6 kbps	19,2 kbps	38,4 kbps	57,6 kbps	115,2 kbps
dec.	hex.									
0	0000	863,0000								
1	0001	863,0125	14dBm	14dBm	14dBm					
2	0002	863,0250	14dBm	14dBm	14dBm	14dBm				
3	0003	863,0375	14dBm	14dBm	14dBm					
4	0004	863,0500	14dBm	14dBm	14dBm	14dBm	14dBm	14dBm		
5	0005	863,0625	14dBm	14dBm	14dBm				14dBm	
6	0006	863,0750	14dBm	14dBm	14dBm	14dBm				
7	0007	863,0875	14dBm	14dBm	14dBm		14dBm			
8	0008	863,1000	14dBm	14dBm	14dBm	14dBm		14dBm		14dBm
9	0009	863,1125	14dBm	14dBm	14dBm					
10	000A	863,1250	14dBm	14dBm	14dBm	14dBm	14dBm			
11	000B	863,1375	14dBm	14dBm	14dBm				14dBm	
12	000C	863,1500	14dBm	14dBm	14dBm	14dBm		14dBm		
13	000D	863,1625	14dBm	14dBm	14dBm		14dBm			
14	000E	863,1750	14dBm	14dBm	14dBm	14dBm				
15	000F	863,1875	14dBm	14dBm	14dBm					
16	0010	863,2000	14dBm	14dBm	14dBm	14dBm	14dBm	14dBm		
17	0011	863,2125	14dBm	14dBm	14dBm				14dBm	
18	0012	863,2250	14dBm	14dBm	14dBm	14dBm				
19	0013	863,2375	14dBm	14dBm	14dBm		14dBm			
20	0014	863,2500	14dBm	14dBm	14dBm	14dBm		14dBm		
21	0015	863,2625	14dBm	14dBm	14dBm					
22	0016	863,2750	14dBm	14dBm	14dBm	14dBm	14dBm			
23	0017	863,2875	14dBm	14dBm	14dBm				14dBm	
24	0018	863,3000	14dBm	14dBm	14dBm	14dBm		14dBm		14dBm
25	0019	863,3125	14dBm	14dBm	14dBm		14dBm			
26	001A	863,3250	14dBm	14dBm	14dBm	14dBm				
27	001B	863,3375	14dBm	14dBm	14dBm					
28	001C	863,3500	14dBm	14dBm	14dBm	14dBm	14dBm	14dBm		
29	001D	863,3625	14dBm	14dBm	14dBm				14dBm	
30	001E	863,3750	14dBm	14dBm	14dBm	14dBm				
31	001F	863,3875	14dBm	14dBm	14dBm		14dBm			
32	0020	863,4000	14dBm	14dBm	14dBm	14dBm		14dBm		
33	0021	863,4125	14dBm	14dBm	14dBm					
34	0022	863,4250	14dBm	14dBm	14dBm	14dBm	14dBm			
35	0023	863,4375	14dBm	14dBm	14dBm				14dBm	
36	0024	863,4500	14dBm	14dBm	14dBm	14dBm		14dBm		
37	0025	863,4625	14dBm	14dBm	14dBm		14dBm			
38	0026	863,4750	14dBm	14dBm	14dBm	14dBm				
39	0027	863,4875	14dBm	14dBm	14dBm					

Channel		Freq.	1,2 kbps	2,4 kbps	4,8 kbps	9,6 kbps	19,2 kbps	38,4 kbps	57,6 kbps	115,2 kbps
dec.	hex.									
40	0028	863,5000	14dBm	14dBm	14dBm	14dBm	14dBm	14dBm		14dBm
41	0029	863,5125	14dBm	14dBm	14dBm				14dBm	
42	002A	863,5250	14dBm	14dBm	14dBm	14dBm				
43	002B	863,5375	14dBm	14dBm	14dBm		14dBm			
44	002C	863,5500	14dBm	14dBm	14dBm	14dBm		14dBm		
45	002D	863,5625	14dBm	14dBm	14dBm					
46	002E	863,5750	14dBm	14dBm	14dBm	14dBm	14dBm			
47	002F	863,5875	14dBm	14dBm	14dBm				14dBm	
48	0030	863,6000	14dBm	14dBm	14dBm	14dBm		14dBm		
49	0031	863,6125	14dBm	14dBm	14dBm		14dBm			
50	0032	863,6250	14dBm	14dBm	14dBm	14dBm				
51	0033	863,6375	14dBm	14dBm	14dBm					
52	0034	863,6500	14dBm	14dBm	14dBm	14dBm	14dBm	14dBm		
53	0035	863,6625	14dBm	14dBm	14dBm				14dBm	
54	0036	863,6750	14dBm	14dBm	14dBm	14dBm				
55	0037	863,6875	14dBm	14dBm	14dBm		14dBm			
56	0038	863,7000	14dBm	14dBm	14dBm	14dBm		14dBm		14dBm
57	0039	863,7125	14dBm	14dBm	14dBm					
58	003A	863,7250	14dBm	14dBm	14dBm	14dBm	14dBm			
59	003B	863,7375	14dBm	14dBm	14dBm				14dBm	
60	003C	863,7500	14dBm	14dBm	14dBm	14dBm		14dBm		
61	003D	863,7625	14dBm	14dBm	14dBm		14dBm			
62	003E	863,7750	14dBm	14dBm	14dBm	14dBm				
63	003F	863,7875	14dBm	14dBm	14dBm					
64	0040	863,8000	14dBm	14dBm	14dBm	14dBm	14dBm	14dBm		
65	0041	863,8125	14dBm	14dBm	14dBm				14dBm	
66	0042	863,8250	14dBm	14dBm	14dBm	14dBm				
67	0043	863,8375	14dBm	14dBm	14dBm		14dBm			
68	0044	863,8500	14dBm	14dBm	14dBm	14dBm		14dBm		
69	0045	863,8625	14dBm	14dBm	14dBm					
70	0046	863,8750	14dBm	14dBm	14dBm	14dBm	14dBm			
71	0047	863,8875	14dBm	14dBm	14dBm				14dBm	
72	0048	863,9000	14dBm	14dBm	14dBm	14dBm		14dBm		14dBm
73	0049	863,9125	14dBm	14dBm	14dBm		14dBm			
74	004A	863,9250	14dBm	14dBm	14dBm	14dBm				
75	004B	863,9375	14dBm	14dBm	14dBm					
76	004C	863,9500	14dBm	14dBm	14dBm	14dBm	14dBm	14dBm		
77	004D	863,9625	14dBm	14dBm	14dBm				14dBm	
78	004E	863,9750	14dBm	14dBm	14dBm	14dBm				
79	004F	863,9875	14dBm	14dBm	14dBm		14dBm			
80	0050	864,0000	14dBm	14dBm	14dBm	14dBm		14dBm		
81	0051	864,0125	14dBm	14dBm	14dBm					

Channel		Freq.	1,2 kbps	2,4 kbps	4,8 kbps	9,6 kbps	19,2 kbps	38,4 kbps	57,6 kbps	115,2 kbps
dec.	hex.									
82	0052	864,0250	14dBm	14dBm	14dBm	14dBm	14dBm			
83	0053	864,0375	14dBm	14dBm	14dBm				14dBm	
84	0054	864,0500	14dBm	14dBm	14dBm	14dBm		14dBm		
85	0055	864,0625	14dBm	14dBm	14dBm		14dBm			
86	0056	864,0750	14dBm	14dBm	14dBm	14dBm				
87	0057	864,0875	14dBm	14dBm	14dBm					
88	0058	864,1000	14dBm	14dBm	14dBm	14dBm	14dBm	14dBm		14dBm
89	0059	864,1125	14dBm	14dBm	14dBm				14dBm	
90	005A	864,1250	14dBm	14dBm	14dBm	14dBm				
91	005B	864,1375	14dBm	14dBm	14dBm		14dBm			
92	005C	864,1500	14dBm	14dBm	14dBm	14dBm		14dBm		
93	005D	864,1625	14dBm	14dBm	14dBm					
94	005E	864,1750	14dBm	14dBm	14dBm	14dBm	14dBm			
95	005F	864,1875	14dBm	14dBm	14dBm				14dBm	
96	0060	864,2000	14dBm	14dBm	14dBm	14dBm		14dBm		
97	0061	864,2125	14dBm	14dBm	14dBm		14dBm			
98	0062	864,2250	14dBm	14dBm	14dBm	14dBm				
99	0063	864,2375	14dBm	14dBm	14dBm					
100	0064	864,2500	14dBm	14dBm	14dBm	14dBm	14dBm	14dBm		
101	0065	864,2625	14dBm	14dBm	14dBm				14dBm	
102	0066	864,2750	14dBm	14dBm	14dBm	14dBm				
103	0067	864,2875	14dBm	14dBm	14dBm		14dBm			
104	0068	864,3000	14dBm	14dBm	14dBm	14dBm		14dBm		14dBm
105	0069	864,3125	14dBm	14dBm	14dBm					
106	006A	864,3250	14dBm	14dBm	14dBm	14dBm	14dBm			
107	006B	864,3375	14dBm	14dBm	14dBm				14dBm	
108	006C	864,3500	14dBm	14dBm	14dBm	14dBm		14dBm		
109	006D	864,3625	14dBm	14dBm	14dBm		14dBm			
110	006E	864,3750	14dBm	14dBm	14dBm	14dBm				
111	006F	864,3875	14dBm	14dBm	14dBm					
112	0070	864,4000	14dBm	14dBm	14dBm	14dBm	14dBm	14dBm		
113	0071	864,4125	14dBm	14dBm	14dBm				14dBm	
114	0072	864,4250	14dBm	14dBm	14dBm	14dBm				
115	0073	864,4375	14dBm	14dBm	14dBm		14dBm			
116	0074	864,4500	14dBm	14dBm	14dBm	14dBm		14dBm		
117	0075	864,4625	14dBm	14dBm	14dBm					
118	0076	864,4750	14dBm	14dBm	14dBm	14dBm	14dBm			
119	0077	864,4875	14dBm	14dBm	14dBm				14dBm	
120	0078	864,5000	14dBm	14dBm	14dBm	14dBm		14dBm		14dBm
121	0079	864,5125	14dBm	14dBm	14dBm		14dBm			
122	007A	864,5250	14dBm	14dBm	14dBm	14dBm				
123	007B	864,5375	14dBm	14dBm	14dBm					

Channel		Freq.	1,2 kbps	2,4 kbps	4,8 kbps	9,6 kbps	19,2 kbps	38,4 kbps	57,6 kbps	115,2 kbps
dec.	hex.									
124	007C	864,5500	14dBm	14dBm	14dBm	14dBm	14dBm	14dBm		
125	007D	864,5625	14dBm	14dBm	14dBm				14dBm	
126	007E	864,5750	14dBm	14dBm	14dBm	14dBm				
127	007F	864,5875	14dBm	14dBm	14dBm		14dBm			
128	0080	864,6000	14dBm	14dBm	14dBm	14dBm		14dBm		
129	0081	864,6125	14dBm	14dBm	14dBm					
130	0082	864,6250	14dBm	14dBm	14dBm	14dBm	14dBm			
131	0083	864,6375	14dBm	14dBm	14dBm				14dBm	
132	0084	864,6500	14dBm	14dBm	14dBm	14dBm		14dBm		
133	0085	864,6625	14dBm	14dBm	14dBm		14dBm			
134	0086	864,6750	14dBm	14dBm	14dBm	14dBm				
135	0087	864,6875	14dBm	14dBm	14dBm					
136	0088	864,7000	14dBm	14dBm	14dBm	14dBm	14dBm	14dBm		14dBm
137	0089	864,7125	14dBm	14dBm	14dBm				14dBm	
138	008A	864,7250	14dBm	14dBm	14dBm	14dBm				
139	008B	864,7375	14dBm	14dBm	14dBm		14dBm			
140	008C	864,7500	14dBm	14dBm	14dBm	14dBm		14dBm		
141	008D	864,7625	14dBm	14dBm	14dBm					
142	008E	864,7750	14dBm	14dBm	14dBm	14dBm	14dBm			
143	008F	864,7875	14dBm	14dBm	14dBm				14dBm	
144	0090	864,8000	14dBm	14dBm	14dBm	14dBm		14dBm		
145	0091	864,8125	14dBm	14dBm	14dBm		14dBm			
146	0092	864,8250	14dBm	14dBm	14dBm	14dBm				
147	0093	864,8375	14dBm	14dBm	14dBm					
148	0094	864,8500	14dBm	14dBm	14dBm	14dBm	14dBm	14dBm		
149	0095	864,8625	14dBm	14dBm	14dBm				14dBm	
150	0096	864,8750	14dBm	14dBm	14dBm	14dBm				
151	0097	864,8875	14dBm	14dBm	14dBm		14dBm			
152	0098	864,9000	14dBm	14dBm	14dBm	14dBm		14dBm		14dBm
153	0099	864,9125	14dBm	14dBm	14dBm					
154	009A	864,9250	14dBm	14dBm	14dBm	14dBm	14dBm			
155	009B	864,9375	14dBm	14dBm	14dBm				14dBm	
156	009C	864,9500	14dBm	14dBm	14dBm	14dBm		14dBm		
157	009D	864,9625	14dBm	14dBm	14dBm		14dBm			
158	009E	864,9750	14dBm	14dBm	14dBm	14dBm				
159	009F	864,9875	14dBm	14dBm	14dBm					
160	00A0	865,0000	14dBm	14dBm	14dBm	14dBm	14dBm	14dBm		
161	00A1	865,0125	14dBm	14dBm	14dBm				14dBm	
162	00A2	865,0250	14dBm	14dBm	14dBm	14dBm				
163	00A3	865,0375	14dBm	14dBm	14dBm		14dBm			
164	00A4	865,0500	14dBm	14dBm	14dBm	14dBm		14dBm		
165	00A5	865,0625	14dBm	14dBm	14dBm					

Channel		Freq.	1,2 kbps	2,4 kbps	4,8 kbps	9,6 kbps	19,2 kbps	38,4 kbps	57,6 kbps	115,2 kbps
dec.	hex.									
166	00A6	865,0750	14dBm	14dBm	14dBm	14dBm	14dBm			
167	00A7	865,0875	14dBm	14dBm	14dBm				14dBm	
168	00A8	865,1000	14dBm	14dBm	14dBm	14dBm		14dBm		14dBm
169	00A9	865,1125	14dBm	14dBm	14dBm		14dBm			
170	00AA	865,1250	14dBm	14dBm	14dBm	14dBm				
171	00AB	865,1375	14dBm	14dBm	14dBm					
172	00AC	865,1500	14dBm	14dBm	14dBm	14dBm	14dBm	14dBm		
173	00AD	865,1625	14dBm	14dBm	14dBm				14dBm	
174	00AE	865,1750	14dBm	14dBm	14dBm	14dBm				
175	00AF	865,1875	14dBm	14dBm	14dBm		14dBm			
176	00B0	865,2000	14dBm	14dBm	14dBm	14dBm		14dBm		
177	00B1	865,2125	14dBm	14dBm	14dBm					
178	00B2	865,2250	14dBm	14dBm	14dBm	14dBm	14dBm			
179	00B3	865,2375	14dBm	14dBm	14dBm				14dBm	
180	00B4	865,2500	14dBm	14dBm	14dBm	14dBm		14dBm		
181	00B5	865,2625	14dBm	14dBm	14dBm		14dBm			
182	00B6	865,2750	14dBm	14dBm	14dBm	14dBm				
183	00B7	865,2875	14dBm	14dBm	14dBm					
184	00B8	865,3000	14dBm	14dBm	14dBm	14dBm	14dBm	14dBm		14dBm
185	00B9	865,3125	14dBm	14dBm	14dBm				14dBm	
186	00BA	865,3250	14dBm	14dBm	14dBm	14dBm				
187	00BB	865,3375	14dBm	14dBm	14dBm		14dBm			
188	00BC	865,3500	14dBm	14dBm	14dBm	14dBm		14dBm		
189	00BD	865,3625	14dBm	14dBm	14dBm					
190	00BE	865,3750	14dBm	14dBm	14dBm	14dBm	14dBm			
191	00BF	865,3875	14dBm	14dBm	14dBm				14dBm	
192	00C0	865,4000	14dBm	14dBm	14dBm	14dBm		14dBm		
193	00C1	865,4125	14dBm	14dBm	14dBm		14dBm			
194	00C2	865,4250	14dBm	14dBm	14dBm	14dBm				
195	00C3	865,4375	14dBm	14dBm	14dBm					
196	00C4	865,4500	14dBm	14dBm	14dBm	14dBm	14dBm	14dBm		
197	00C5	865,4625	14dBm	14dBm	14dBm				14dBm	
198	00C6	865,4750	14dBm	14dBm	14dBm	14dBm				
199	00C7	865,4875	14dBm	14dBm	14dBm		14dBm			
200	00C8	865,5000	14dBm	14dBm	14dBm	14dBm		14dBm		14dBm
201	00C9	865,5125	14dBm	14dBm	14dBm					
202	00CA	865,5250	14dBm	14dBm	14dBm	14dBm	14dBm			
203	00CB	865,5375	14dBm	14dBm	14dBm				14dBm	
204	00CC	865,5500	14dBm	14dBm	14dBm	14dBm		14dBm		
205	00CD	865,5625	14dBm	14dBm	14dBm		14dBm			
206	00CE	865,5750	14dBm	14dBm	14dBm	14dBm				
207	00CF	865,5875	14dBm	14dBm	14dBm					

Channel		Freq.	1,2 kbps	2,4 kbps	4,8 kbps	9,6 kbps	19,2 kbps	38,4 kbps	57,6 kbps	115,2 kbps
dec.	hex.									
208	00D0	865,6000	14dBm	14dBm	14dBm	14dBm	14dBm	14dBm		
209	00D1	865,6125	14dBm	14dBm	14dBm				14dBm	
210	00D2	865,6250	14dBm	14dBm	14dBm	14dBm				
211	00D3	865,6375	14dBm	14dBm	14dBm		14dBm			
212	00D4	865,6500	14dBm	14dBm	14dBm	14dBm		14dBm		
213	00D5	865,6625	14dBm	14dBm	14dBm					
214	00D6	865,6750	14dBm	14dBm	14dBm	14dBm	14dBm			
215	00D7	865,6875	14dBm	14dBm	14dBm				14dBm	
216	00D8	865,7000	14dBm	14dBm	14dBm	14dBm		14dBm		14dBm
217	00D9	865,7125	14dBm	14dBm	14dBm		14dBm			
218	00DA	865,7250	14dBm	14dBm	14dBm	14dBm				
219	00DB	865,7375	14dBm	14dBm	14dBm					
220	00DC	865,7500	14dBm	14dBm	14dBm	14dBm	14dBm	14dBm		
221	00DD	865,7625	14dBm	14dBm	14dBm				14dBm	
222	00DE	865,7750	14dBm	14dBm	14dBm	14dBm				
223	00DF	865,7875	14dBm	14dBm	14dBm		14dBm			
224	00E0	865,8000	14dBm	14dBm	14dBm	14dBm		14dBm		
225	00E1	865,8125	14dBm	14dBm	14dBm					
226	00E2	865,8250	14dBm	14dBm	14dBm	14dBm	14dBm			
227	00E3	865,8375	14dBm	14dBm	14dBm				14dBm	
228	00E4	865,8500	14dBm	14dBm	14dBm	14dBm		14dBm		
229	00E5	865,8625	14dBm	14dBm	14dBm		14dBm			
230	00E6	865,8750	14dBm	14dBm	14dBm	14dBm				
231	00E7	865,8875	14dBm	14dBm	14dBm					
232	00E8	865,9000	14dBm	14dBm	14dBm	14dBm	14dBm	14dBm		14dBm
233	00E9	865,9125	14dBm	14dBm	14dBm				14dBm	
234	00EA	865,9250	14dBm	14dBm	14dBm	14dBm				
235	00EB	865,9375	14dBm	14dBm	14dBm		14dBm			
236	00EC	865,9500	14dBm	14dBm	14dBm	14dBm		14dBm		
237	00ED	865,9625	14dBm	14dBm	14dBm					
238	00EE	865,9750	14dBm	14dBm	14dBm	14dBm	14dBm			
239	00EF	865,9875	14dBm	14dBm	14dBm				14dBm	
240	00F0	866,0000	14dBm	14dBm	14dBm	14dBm		14dBm		
241	00F1	866,0125	14dBm	14dBm	14dBm		14dBm			
242	00F2	866,0250	14dBm	14dBm	14dBm	14dBm				
243	00F3	866,0375	14dBm	14dBm	14dBm					
244	00F4	866,0500	14dBm	14dBm	14dBm	14dBm	14dBm	14dBm		
245	00F5	866,0625	14dBm	14dBm	14dBm				14dBm	
246	00F6	866,0750	14dBm	14dBm	14dBm	14dBm				
247	00F7	866,0875	14dBm	14dBm	14dBm		14dBm			
248	00F8	866,1000	14dBm	14dBm	14dBm	14dBm		14dBm		14dBm
249	00F9	866,1125	14dBm	14dBm	14dBm					

Channel		Freq.	1,2 kbps	2,4 kbps	4,8 kbps	9,6 kbps	19,2 kbps	38,4 kbps	57,6 kbps	115,2 kbps
dec.	hex.									
250	00FA	866,1250	14dBm	14dBm	14dBm	14dBm	14dBm			
251	00FB	866,1375	14dBm	14dBm	14dBm				14dBm	
252	00FC	866,1500	14dBm	14dBm	14dBm	14dBm		14dBm		
253	00FD	866,1625	14dBm	14dBm	14dBm		14dBm			
254	00FE	866,1750	14dBm	14dBm	14dBm	14dBm				
255	00FF	866,1875	14dBm	14dBm	14dBm					
256	0100	866,2000	14dBm	14dBm	14dBm	14dBm	14dBm	14dBm		
257	0101	866,2125	14dBm	14dBm	14dBm				14dBm	
258	0102	866,2250	14dBm	14dBm	14dBm	14dBm				
259	0103	866,2375	14dBm	14dBm	14dBm		14dBm			
260	0104	866,2500	14dBm	14dBm	14dBm	14dBm		14dBm		
261	0105	866,2625	14dBm	14dBm	14dBm					
262	0106	866,2750	14dBm	14dBm	14dBm	14dBm	14dBm			
263	0107	866,2875	14dBm	14dBm	14dBm				14dBm	
264	0108	866,3000	14dBm	14dBm	14dBm	14dBm		14dBm		14dBm
265	0109	866,3125	14dBm	14dBm	14dBm		14dBm			
266	010A	866,3250	14dBm	14dBm	14dBm	14dBm				
267	010B	866,3375	14dBm	14dBm	14dBm					
268	010C	866,3500	14dBm	14dBm	14dBm	14dBm	14dBm	14dBm		
269	010D	866,3625	14dBm	14dBm	14dBm				14dBm	
270	010E	866,3750	14dBm	14dBm	14dBm	14dBm				
271	010F	866,3875	14dBm	14dBm	14dBm		14dBm			
272	0110	866,4000	14dBm	14dBm	14dBm	14dBm		14dBm		
273	0111	866,4125	14dBm	14dBm	14dBm					
274	0112	866,4250	14dBm	14dBm	14dBm	14dBm	14dBm			
275	0113	866,4375	14dBm	14dBm	14dBm				14dBm	
276	0114	866,4500	14dBm	14dBm	14dBm	14dBm		14dBm		
277	0115	866,4625	14dBm	14dBm	14dBm		14dBm			
278	0116	866,4750	14dBm	14dBm	14dBm	14dBm				
279	0117	866,4875	14dBm	14dBm	14dBm					
280	0118	866,5000	14dBm	14dBm	14dBm	14dBm	14dBm	14dBm		14dBm
281	0119	866,5125	14dBm	14dBm	14dBm				14dBm	
282	011A	866,5250	14dBm	14dBm	14dBm	14dBm				
283	011B	866,5375	14dBm	14dBm	14dBm		14dBm			
284	011C	866,5500	14dBm	14dBm	14dBm	14dBm		14dBm		
285	011D	866,5625	14dBm	14dBm	14dBm					
286	011E	866,5750	14dBm	14dBm	14dBm	14dBm	14dBm			
287	011F	866,5875	14dBm	14dBm	14dBm				14dBm	
288	0120	866,6000	14dBm	14dBm	14dBm	14dBm		14dBm		
289	0121	866,6125	14dBm	14dBm	14dBm		14dBm			
290	0122	866,6250	14dBm	14dBm	14dBm	14dBm				
291	0123	866,6375	14dBm	14dBm	14dBm					

Channel		Freq.	1,2 kbps	2,4 kbps	4,8 kbps	9,6 kbps	19,2 kbps	38,4 kbps	57,6 kbps	115,2 kbps
dec.	hex.									
292	0124	866,6500	14dBm	14dBm	14dBm	14dBm	14dBm	14dBm		
293	0125	866,6625	14dBm	14dBm	14dBm				14dBm	
294	0126	866,6750	14dBm	14dBm	14dBm	14dBm				
295	0127	866,6875	14dBm	14dBm	14dBm		14dBm			
296	0128	866,7000	14dBm	14dBm	14dBm	14dBm		14dBm		14dBm
297	0129	866,7125	14dBm	14dBm	14dBm					
298	012A	866,7250	14dBm	14dBm	14dBm	14dBm	14dBm			
299	012B	866,7375	14dBm	14dBm	14dBm				14dBm	
300	012C	866,7500	14dBm	14dBm	14dBm	14dBm		14dBm		
301	012D	866,7625	14dBm	14dBm	14dBm		14dBm			
302	012E	866,7750	14dBm	14dBm	14dBm	14dBm				
303	012F	866,7875	14dBm	14dBm	14dBm					
304	0130	866,8000	14dBm	14dBm	14dBm	14dBm	14dBm	14dBm		
305	0131	866,8125	14dBm	14dBm	14dBm				14dBm	
306	0132	866,8250	14dBm	14dBm	14dBm	14dBm				
307	0133	866,8375	14dBm	14dBm	14dBm		14dBm			
308	0134	866,8500	14dBm	14dBm	14dBm	14dBm		14dBm		
309	0135	866,8625	14dBm	14dBm	14dBm					
310	0136	866,8750	14dBm	14dBm	14dBm	14dBm	14dBm			
311	0137	866,8875	14dBm	14dBm	14dBm				14dBm	
312	0138	866,9000	14dBm	14dBm	14dBm	14dBm		14dBm		14dBm
313	0139	866,9125	14dBm	14dBm	14dBm		14dBm			
314	013A	866,9250	14dBm	14dBm	14dBm	14dBm				
315	013B	866,9375	14dBm	14dBm	14dBm					
316	013C	866,9500	14dBm	14dBm	14dBm	14dBm	14dBm	14dBm		
317	013D	866,9625	14dBm	14dBm	14dBm				14dBm	
318	013E	866,9750	14dBm	14dBm	14dBm	14dBm				
319	013F	866,9875	14dBm	14dBm	14dBm		14dBm			
320	0140	867,0000	14dBm	14dBm	14dBm	14dBm		14dBm		
321	0141	867,0125	14dBm	14dBm	14dBm					
322	0142	867,0250	14dBm	14dBm	14dBm	14dBm	14dBm			
323	0143	867,0375	14dBm	14dBm	14dBm				14dBm	
324	0144	867,0500	14dBm	14dBm	14dBm	14dBm		14dBm		
325	0145	867,0625	14dBm	14dBm	14dBm		14dBm			
326	0146	867,0750	14dBm	14dBm	14dBm	14dBm				
327	0147	867,0875	14dBm	14dBm	14dBm					
328	0148	867,1000	14dBm	14dBm	14dBm	14dBm	14dBm	14dBm		14dBm
329	0149	867,1125	14dBm	14dBm	14dBm				14dBm	
330	014A	867,1250	14dBm	14dBm	14dBm	14dBm				
331	014B	867,1375	14dBm	14dBm	14dBm		14dBm			
332	014C	867,1500	14dBm	14dBm	14dBm	14dBm		14dBm		
333	014D	867,1625	14dBm	14dBm	14dBm					

Channel		Freq.	1,2 kbps	2,4 kbps	4,8 kbps	9,6 kbps	19,2 kbps	38,4 kbps	57,6 kbps	115,2 kbps
dec.	hex.									
334	014E	867,1750	14dBm	14dBm	14dBm	14dBm	14dBm			
335	014F	867,1875	14dBm	14dBm	14dBm				14dBm	
336	0150	867,2000	14dBm	14dBm	14dBm	14dBm		14dBm		
337	0151	867,2125	14dBm	14dBm	14dBm		14dBm			
338	0152	867,2250	14dBm	14dBm	14dBm	14dBm				
339	0153	867,2375	14dBm	14dBm	14dBm					
340	0154	867,2500	14dBm	14dBm	14dBm	14dBm	14dBm	14dBm		
341	0155	867,2625	14dBm	14dBm	14dBm				14dBm	
342	0156	867,2750	14dBm	14dBm	14dBm	14dBm				
343	0157	867,2875	14dBm	14dBm	14dBm		14dBm			
344	0158	867,3000	14dBm	14dBm	14dBm	14dBm		14dBm		14dBm
345	0159	867,3125	14dBm	14dBm	14dBm					
346	015A	867,3250	14dBm	14dBm	14dBm	14dBm	14dBm			
347	015B	867,3375	14dBm	14dBm	14dBm				14dBm	
348	015C	867,3500	14dBm	14dBm	14dBm	14dBm		14dBm		
349	015D	867,3625	14dBm	14dBm	14dBm		14dBm			
350	015E	867,3750	14dBm	14dBm	14dBm	14dBm				
351	015F	867,3875	14dBm	14dBm	14dBm					
352	0160	867,4000	14dBm	14dBm	14dBm	14dBm	14dBm	14dBm		
353	0161	867,4125	14dBm	14dBm	14dBm				14dBm	
354	0162	867,4250	14dBm	14dBm	14dBm	14dBm				
355	0163	867,4375	14dBm	14dBm	14dBm		14dBm			
356	0164	867,4500	14dBm	14dBm	14dBm	14dBm		14dBm		
357	0165	867,4625	14dBm	14dBm	14dBm					
358	0166	867,4750	14dBm	14dBm	14dBm	14dBm	14dBm			
359	0167	867,4875	14dBm	14dBm	14dBm				14dBm	
360	0168	867,5000	14dBm	14dBm	14dBm	14dBm		14dBm		14dBm
361	0169	867,5125	14dBm	14dBm	14dBm		14dBm			
362	016A	867,5250	14dBm	14dBm	14dBm	14dBm				
363	016B	867,5375	14dBm	14dBm	14dBm					
364	016C	867,5500	14dBm	14dBm	14dBm	14dBm	14dBm	14dBm		
365	016D	867,5625	14dBm	14dBm	14dBm				14dBm	
366	016E	867,5750	14dBm	14dBm	14dBm	14dBm				
367	016F	867,5875	14dBm	14dBm	14dBm		14dBm			
368	0170	867,6000	14dBm	14dBm	14dBm	14dBm		14dBm		
369	0171	867,6125	14dBm	14dBm	14dBm					
370	0172	867,6250	14dBm	14dBm	14dBm	14dBm	14dBm			
371	0173	867,6375	14dBm	14dBm	14dBm				14dBm	
372	0174	867,6500	14dBm	14dBm	14dBm	14dBm		14dBm		
373	0175	867,6625	14dBm	14dBm	14dBm		14dBm			
374	0176	867,6750	14dBm	14dBm	14dBm	14dBm				
375	0177	867,6875	14dBm	14dBm	14dBm					

Channel		Freq.	1,2 kbps	2,4 kbps	4,8 kbps	9,6 kbps	19,2 kbps	38,4 kbps	57,6 kbps	115,2 kbps
dec.	hex.									
376	0178	867,7000	14dBm	14dBm	14dBm	14dBm	14dBm	14dBm		14dBm
377	0179	867,7125	14dBm	14dBm	14dBm				14dBm	
378	017A	867,7250	14dBm	14dBm	14dBm	14dBm				
379	017B	867,7375	14dBm	14dBm	14dBm		14dBm			
380	017C	867,7500	14dBm	14dBm	14dBm	14dBm		14dBm		
381	017D	867,7625	14dBm	14dBm	14dBm					
382	017E	867,7750	14dBm	14dBm	14dBm	14dBm	14dBm			
383	017F	867,7875	14dBm	14dBm	14dBm				14dBm	
384	0180	867,8000	14dBm	14dBm	14dBm	14dBm		14dBm		
385	0181	867,8125	14dBm	14dBm	14dBm		14dBm			
386	0182	867,8250	14dBm	14dBm	14dBm	14dBm				
387	0183	867,8375	14dBm	14dBm	14dBm					
388	0184	867,8500	14dBm	14dBm	14dBm	14dBm	14dBm	14dBm		
389	0185	867,8625	14dBm	14dBm	14dBm				14dBm	
390	0186	867,8750	14dBm	14dBm	14dBm	14dBm				
391	0187	867,8875	14dBm	14dBm	14dBm		14dBm			
392	0188	867,9000	14dBm	14dBm	14dBm	14dBm		14dBm		14dBm
393	0189	867,9125	14dBm	14dBm	14dBm					
394	018A	867,9250	14dBm	14dBm	14dBm	14dBm	14dBm			
395	018B	867,9375	14dBm	14dBm	14dBm				14dBm	
396	018C	867,9500	14dBm	14dBm	14dBm	14dBm		14dBm		
397	018D	867,9625	14dBm	14dBm	14dBm		14dBm			
398	018E	867,9750	14dBm	14dBm	14dBm	14dBm				
399	018F	867,9875	14dBm	14dBm	14dBm					
400	0190	868,0000	14dBm	14dBm	14dBm	14dBm	14dBm	14dBm		
401	0191	868,0125	14dBm	14dBm	14dBm				14dBm	
402	0192	868,0250	14dBm	14dBm	14dBm	14dBm				
403	0193	868,0375	14dBm	14dBm	14dBm		14dBm			
404	0194	868,0500	14dBm	14dBm	14dBm	14dBm		14dBm		
405	0195	868,0625	14dBm	14dBm	14dBm					
406	0196	868,0750	14dBm	14dBm	14dBm	14dBm	14dBm			
407	0197	868,0875	14dBm	14dBm	14dBm				14dBm	
408	0198	868,1000	14dBm	14dBm	14dBm	14dBm		14dBm		14dBm
409	0199	868,1125	14dBm	14dBm	14dBm		14dBm			
410	019A	868,1250	14dBm	14dBm	14dBm	14dBm				
411	019B	868,1375	14dBm	14dBm	14dBm					
412	019C	868,1500	14dBm	14dBm	14dBm	14dBm	14dBm	14dBm		
413	019D	868,1625	14dBm	14dBm	14dBm				14dBm	
414	019E	868,1750	14dBm	14dBm	14dBm	14dBm				
415	019F	868,1875	14dBm	14dBm	14dBm		14dBm			
416	01A0	868,2000	14dBm	14dBm	14dBm	14dBm		14dBm		
417	01A1	868,2125	14dBm	14dBm	14dBm					

Channel		Freq.	1,2 kbps	2,4 kbps	4,8 kbps	9,6 kbps	19,2 kbps	38,4 kbps	57,6 kbps	115,2 kbps
dec.	hex.									
418	01A2	868,2250	14dBm	14dBm	14dBm	14dBm	14dBm			
419	01A3	868,2375	14dBm	14dBm	14dBm				14dBm	
420	01A4	868,2500	14dBm	14dBm	14dBm	14dBm		14dBm		
421	01A5	868,2625	14dBm	14dBm	14dBm		14dBm			
422	01A6	868,2750	14dBm	14dBm	14dBm	14dBm				
423	01A7	868,2875	14dBm	14dBm	14dBm					
424	01A8	868,3000	14dBm	14dBm	14dBm	14dBm	14dBm	14dBm		14dBm
425	01A9	868,3125	14dBm	14dBm	14dBm				14dBm	
426	01AA	868,3250	14dBm	14dBm	14dBm	14dBm				
427	01AB	868,3375	14dBm	14dBm	14dBm		14dBm			
428	01AC	868,3500	14dBm	14dBm	14dBm	14dBm		14dBm		
429	01AD	868,3625	14dBm	14dBm	14dBm					
430	01AE	868,3750	14dBm	14dBm	14dBm	14dBm	14dBm			
431	01AF	868,3875	14dBm	14dBm	14dBm				14dBm	
432	01B0	868,4000	14dBm	14dBm	14dBm	14dBm		14dBm		
433	01B1	868,4125	14dBm	14dBm	14dBm		14dBm			
434	01B2	868,4250	14dBm	14dBm	14dBm	14dBm				
435	01B3	868,4375	14dBm	14dBm	14dBm					
436	01B4	868,4500	14dBm	14dBm	14dBm	14dBm	14dBm	14dBm		
437	01B5	868,4625	14dBm	14dBm	14dBm				14dBm	
438	01B6	868,4750	14dBm	14dBm	14dBm	14dBm				
439	01B7	868,4875	14dBm	14dBm	14dBm		14dBm			
440	01B8	868,5000	14dBm	14dBm	14dBm	14dBm		14dBm		14dBm
441	01B9	868,5125	14dBm	14dBm	14dBm					
442	01BA	868,5250	14dBm	14dBm	14dBm	14dBm	14dBm			
443	01BB	868,5375	14dBm	14dBm	14dBm				14dBm	
444	01BC	868,5500	14dBm	14dBm	14dBm	14dBm		14dBm		
445	01BD	868,5625	14dBm	14dBm	14dBm		14dBm			
446	01BE	868,5750	14dBm	14dBm	14dBm	14dBm				
447	01BF	868,5875	14dBm	14dBm	14dBm					
448	01C0	868,6000	14dBm	14dBm	14dBm	14dBm	14dBm	14dBm		
449	01C1	868,6125	14dBm	14dBm	14dBm				14dBm	
450	01C2	868,6250	14dBm	14dBm	14dBm	14dBm				
451	01C3	868,6375	14dBm	14dBm	14dBm		14dBm			
452	01C4	868,6500	14dBm	14dBm	14dBm	14dBm		14dBm		
453	01C5	868,6625	14dBm	14dBm	14dBm					
454	01C6	868,6750	14dBm	14dBm	14dBm	14dBm	14dBm			
455	01C7	868,6875	14dBm	14dBm	14dBm				14dBm	
456	01C8	868,7000	14dBm	14dBm	14dBm	14dBm		14dBm		14dBm
457	01C9	868,7125	14dBm	14dBm	14dBm		14dBm			
458	01CA	868,7250	14dBm	14dBm	14dBm	14dBm				
459	01CB	868,7375	14dBm	14dBm	14dBm					

Channel		Freq.	1,2 kbps	2,4 kbps	4,8 kbps	9,6 kbps	19,2 kbps	38,4 kbps	57,6 kbps	115,2 kbps
dec.	hex.									
460	01CC	868,7500	14dBm	14dBm	14dBm	14dBm	14dBm	14dBm		
461	01CD	868,7625	14dBm	14dBm	14dBm				14dBm	
462	01CE	868,7750	14dBm	14dBm	14dBm	14dBm				
463	01CF	868,7875	14dBm	14dBm	14dBm		14dBm			
464	01D0	868,8000	14dBm	14dBm	14dBm	14dBm		14dBm		
465	01D1	868,8125	14dBm	14dBm	14dBm					
466	01D2	868,8250	14dBm	14dBm	14dBm	14dBm	14dBm			
467	01D3	868,8375	14dBm	14dBm	14dBm				14dBm	
468	01D4	868,8500	14dBm	14dBm	14dBm	14dBm		14dBm		
469	01D5	868,8625	14dBm	14dBm	14dBm		14dBm			
470	01D6	868,8750	14dBm	14dBm	14dBm	14dBm				
471	01D7	868,8875	14dBm	14dBm	14dBm					
472	01D8	868,9000	14dBm	14dBm	14dBm	14dBm	14dBm	14dBm		14dBm
473	01D9	868,9125	14dBm	14dBm	14dBm				14dBm	
474	01DA	868,9250	14dBm	14dBm	14dBm	14dBm				
475	01DB	868,9375	14dBm	14dBm	14dBm		14dBm			
476	01DC	868,9500	14dBm	14dBm	14dBm	14dBm		14dBm		
477	01DD	868,9625	14dBm	14dBm	14dBm					
478	01DE	868,9750	14dBm	14dBm	14dBm	14dBm	14dBm			
479	01DF	868,9875	14dBm	14dBm	14dBm				14dBm	
480	01E0	869,0000	14dBm	14dBm	14dBm	14dBm		14dBm		
481	01E1	869,0125	14dBm	14dBm	14dBm		14dBm			
482	01E2	869,0250	14dBm	14dBm	14dBm	14dBm				
483	01E3	869,0375	14dBm	14dBm	14dBm					
484	01E4	869,0500	14dBm	14dBm	14dBm	14dBm	14dBm	14dBm		
485	01E5	869,0625	14dBm	14dBm	14dBm				14dBm	
486	01E6	869,0750	14dBm	14dBm	14dBm	14dBm				
487	01E7	869,0875	14dBm	14dBm	14dBm		14dBm			
488	01E8	869,1000	14dBm	14dBm	14dBm	14dBm		14dBm		14dBm
489	01E9	869,1125	14dBm	14dBm	14dBm					
490	01EA	869,1250	14dBm	14dBm	14dBm	14dBm	14dBm			
491	01EB	869,1375	14dBm	14dBm	14dBm				14dBm	
492	01EC	869,1500	14dBm	14dBm	14dBm	14dBm		14dBm		
493	01ED	869,1625	14dBm	14dBm	14dBm		14dBm			
494	01EE	869,1750	14dBm	14dBm	14dBm	14dBm				
495	01EF	869,1875	14dBm	14dBm	14dBm					
496	01F0	869,2000	14dBm	14dBm	14dBm	14dBm	14dBm	14dBm		
497	01F1	869,2125	14dBm	14dBm	14dBm				14dBm	
498	01F2	869,2250	14dBm	14dBm	14dBm	14dBm				
499	01F3	869,2375	14dBm	14dBm	14dBm		14dBm			
500	01F4	869,2500	14dBm	14dBm	14dBm	14dBm		14dBm		
501	01F5	869,2625	14dBm	14dBm	14dBm					

Channel		Freq.	1,2 kbps	2,4 kbps	4,8 kbps	9,6 kbps	19,2 kbps	38,4 kbps	57,6 kbps	115,2 kbps
dec.	hex.									
502	01F6	869,2750	14dBm	14dBm	14dBm	14dBm	14dBm			
503	01F7	869,2875	14dBm	14dBm	14dBm				14dBm	
504	01F8	869,3000	14dBm	14dBm	14dBm	14dBm		14dBm		14dBm
505	01F9	869,3125	14dBm	14dBm	14dBm		14dBm			
506	01FA	869,3250	14dBm	14dBm	14dBm	14dBm				
507	01FB	869,3375	14dBm	14dBm	14dBm					
508	01FC	869,3500	14dBm	14dBm	14dBm	14dBm	14dBm	14dBm		
509	01FD	869,3625	14dBm	14dBm	14dBm					
510	01FE	869,3750	14dBm	14dBm	14dBm	14dBm				
511	01FF	869,3875	14dBm	14dBm	14dBm					
512	0200	869,4000								
513	0201	869,4125	21dBm	21dBm	21dBm					
514	0202	869,4250	21dBm	21dBm	21dBm	21dBm				
515	0203	869,4375	23dBm	23dBm	23dBm					
516	0204	869,4500	23dBm	23dBm	23dBm	23dBm	23dBm	23dBm		
517	0205	869,4625	27dBm	27dBm	27dBm				27dBm	
518	0206	869,4750	27dBm	27dBm	27dBm	27dBm		27dBm		
519	0207	869,4875	27dBm	27dBm	27dBm		27dBm			
520	0208	869,5000	27dBm	27dBm	27dBm	27dBm		27dBm		
521	0209	869,5125	27dBm	27dBm	27dBm					
522	020A	869,5250	27dBm	27dBm	27dBm	27dBm	27dBm	27dBm	27dBm	27dBm
523	020B	869,5375	27dBm	27dBm	27dBm					
524	020C	869,5500	27dBm	27dBm	27dBm	27dBm		27dBm		
525	020D	869,5625	27dBm	27dBm	27dBm		27dBm			
526	020E	869,5750	27dBm	27dBm	27dBm	27dBm		27dBm		
527	020F	869,5875	27dBm	27dBm	27dBm				27dBm	
528	0210	869,6000	23dBm	23dBm	23dBm	23dBm	23dBm	23dBm		
529	0211	869,6125	23dBm	23dBm	23dBm					
530	0212	869,6250	21dBm	21dBm	21dBm	21dBm				
531	0213	869,6375	21dBm	21dBm	21dBm					
532	0214	869,6500								
533	0215	869,6625	14dBm	14dBm	14dBm					
534	0216	869,6750	14dBm	14dBm	14dBm	14dBm				
535	0217	869,6875	14dBm	14dBm	14dBm					
536	0218	869,7000	14dBm	14dBm	14dBm	14dBm	14dBm	14dBm		
537	0219	869,7125	14dBm	14dBm	14dBm				14dBm	
538	021A	869,7250	14dBm	14dBm	14dBm	14dBm				
539	021B	869,7375	14dBm	14dBm	14dBm		14dBm			
540	021C	869,7500	14dBm	14dBm	14dBm	14dBm		14dBm		14dBm
541	021D	869,7625	14dBm	14dBm	14dBm					
542	021E	869,7750	14dBm	14dBm	14dBm	14dBm	14dBm			
543	021F	869,7875	14dBm	14dBm	14dBm				14dBm	

Channel		Freq.	1,2 kbps	2,4 kbps	4,8 kbps	9,6 kbps	19,2 kbps	38,4 kbps	57,6 kbps	115,2 kbps
dec.	hex.									
544	0220	869,8000	14dBm	14dBm	14dBm	14dBm		14dBm		
545	0221	869,8125	14dBm	14dBm	14dBm		14dBm			
546	0222	869,8250	14dBm	14dBm	14dBm	14dBm				
547	0223	869,8375	14dBm	14dBm	14dBm					
548	0224	869,8500	14dBm	14dBm	14dBm	14dBm	14dBm	14dBm		
549	0225	869,8625	14dBm	14dBm	14dBm				14dBm	
550	0226	869,8750	14dBm	14dBm	14dBm	14dBm				
551	0227	869,8875	14dBm	14dBm	14dBm		14dBm			
552	0228	869,9000	14dBm	14dBm	14dBm	14dBm		14dBm		
553	0229	869,9125	14dBm	14dBm	14dBm					
554	022A	869,9250	14dBm	14dBm	14dBm	14dBm	14dBm			
555	022B	869,9375	14dBm	14dBm	14dBm				14dBm	
556	022C	869,9500	14dBm	14dBm	14dBm	14dBm		14dBm		
557	022D	869,9625	14dBm	14dBm	14dBm		14dBm			
558	022E	869,9750	14dBm	14dBm	14dBm	14dBm				
559	022F	869,9875	14dBm	14dBm	14dBm					
560	0230	870,0000								