

**Gasmate**  
the outdoors made easy

# PLATINUM III

## **The Gasmate Platinum III Series**

Allows you to create your own stunning outdoor cooking and entertaining area



# PLATINUM III KITCHEN

INCLUDED: GASMATE PLATINUM III BBQ, STORAGE MODULE, SINK MODULE, ROTESSERIE KIT AND VINYL COVER

I/N 3171289  
MODEL NO.  
BQ1080KIT

 #304 GRADE STAINLESS STEEL BBQ AND MODULES

 SUPPLIED FULLY ASSEMBLED FOR QUICK AND EASY INSTALLATION

 INCLUDES ROTISSERIE KIT AND PROTECTIVE VINYL COVER

 FLEXIBLE LAYOUT COMBINATIONS

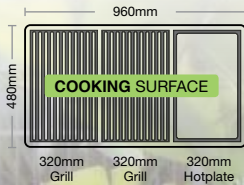

COMPLETE OUTDOOR KITCHEN WITH POWERFUL 6 BURNER BBQ WITH SIDE BURNER, SINK AND STORAGE MODULES WITH BLACK GRANITE BENCH TOPS

BBQ FEATURES FULL SIZE COOKING SURFACE (960mm X 480mm), HOOD WITH VIEWING WINDOW, INTERNAL LIGHTS AND ON CONTROL KNOBS, ELECTRONIC IGNITION, SIDE BURNER AND REAR CERAMIC BURNER

STORAGE MODULE PROVIDES AMPLE BENCH SPACE AND INSIDE THE CABINET THERE ARE 3 SHELVES AND PLENTY OF ROOM TO KEEP THINGS ORGANISED

SINK MODULE HAS WELLS RATED HOT AND COLD MIXER TAP THAT CAN BE PLUMBED IN. THE GENEROUS SIZED SINK CAN BE MOUNTED ON EITHER THE LEFT OR RIGHT SIDE OF THE MODULE

ABILITY TO ADD 1 & 2 DOOR FRIDGE AND MATCHING GRANITE TOP (SOLD SEPARATELY)

MATCHING RANGEHOOD AVAILABLE (SOLD SEPARATELY)

DIMENSIONS:  
3130mm (W) X 630mm (D) X 1200mm (H)

AGA CERTIFIED AND SUITABLE FOR NATURAL GAS CONVERSION



Delivery options for kitchen includes a home delivery service to selected areas only. Terms and conditions apply. See team members for further details



# PLATINUM III SERIES

## INDIVIDUAL BBQ'S AND MODULES

### CREATE YOUR OWN ENTERTAINING AREA

The Gasmate Platinum III Series allows you to create your own stunning outdoor cooking and entertaining area. Start with the Platinum III 6 Burner BBQ and add the Platinum III Series Modules that you need. The BBQ and modules can be arranged in any combination, tailor them to suit your own area or budget. You can even add more modules later.













Or buy the Gasmate Platinum III Built-In BBQ to build into your own cabinetry.

There is a stainless steel professional rangehood and bar fridges to choose from, to really finish off your outdoor kitchen.

The possibilities are endless!

# PLATINUM III BBQ

I/N 3171290  
MODEL NO.  
BQ1080

 #304 GRADE STAINLESS STEEL BBQ SUPPLIED FULLY ASSEMBLED	 STAINLESS STEEL FLAME TAMERS FOR EVEN HEAT DISTRIBUTION
 #304 GRADE STAINLESS STEEL HOOD WITH GLASS VIEWING WINDOW	 CERAMIC REAR BURNER FOR HEALTHY ROTISSERIE COOKING
 TEMPERATURE GAUGE AND COOL TOUCH HANDLE	 COMPLETE WITH STAINLESS STEEL WARMING RACK
 TWO CONVENIENT INTERNAL LIGHTS AND BLUE LED'S ON CONTROL KNOBS	 CONVENIENT SLIDE-OUT CYLINDER STORAGE
 ELECTRONIC IGNITION FOR EFFORTLESS LIGHTING	 LOCKING CASTORS
 STAINLESS STEEL BURNERS WITH INDIVIDUAL CONTROLS	 AGA CERTIFIED AND APPROVED FOR NATURAL GAS CONVERSION

- With integrated high output side burner
- Supplied with hose and regulator
- Powerful combined output of 96MJ/h (6 x 11.6MJ/h burners + 15MJ/h side burner + 11.5MJ/h rear burner)
- **1470mm W x 630mm D x 1200mm H**

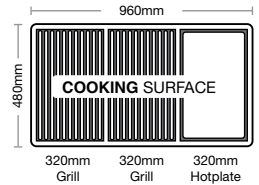

# PLATINUM III BUILT-IN BBQ

I/N 3171291  
MODEL NO.  
BQ1080B

- #304 GRADE STAINLESS STEEL BBQ SUPPLIED FULLY ASSEMBLED
- #304 GRADE STAINLESS STEEL HOOD WITH GLASS VIEWING WINDOW
- TEMPERATURE GAUGE AND COOL TOUCH HANDLE
- CONVENIENT INTERNAL LIGHTS AND BLUE LED ON CONTROL KNOBS
- ELECTRONIC IGNITION FOR EFFORTLESS LIGHTING
- SATIN ENAMEL CAST IRON REVERSIBLE PLATE AND STAINLESS STEEL GRILL
- STAINLESS STEEL BURNERS WITH INDIVIDUAL CONTROLS
- STAINLESS STEEL FLAME TAMERS FOR CONTROLLED HEAT DISTRIBUTION
- CERAMIC REAR BURNER FOR HEALTHY ROTISSERIE COOKING
- COMPLETE WITH STAINLESS STEEL WARMING RACK
- AGA CERTIFIED AND APPROVED FOR NATURAL GAS CONVERSION
- INCLUDES HANGING BRACKETS OR ADJUSTABLE FEET FOR MOUNTING PREFERENCE

- With integrated high output side burner
- Supplied with hose and regulator
- Powerful combined output of 96MJ/h (6 x 11.6MJ/h burners + 15MJ/h side burner + 11.5MJ/h rear burner)
- **1470mm W x 630mm D x 530mm H**

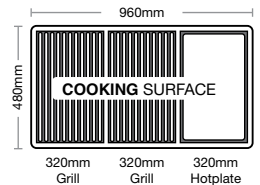

**PLATINUM III  
STORAGE MODULE**

**I/N 3171293  
MODEL NO.  
BQ1082**



STYLISH INTEGRATED HANDLES

INCLUDES 3 STORAGE SHELVES

LOCKING CASTORS

BLACK GRANITE TOP

Premium #304 grade stainless steel cabinet

- Supplied fully assembled
- 830mm W x 630mm D x 905mm H

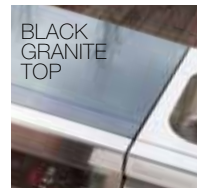

BLACK GRANITE TOP

**PLATINUM III SINK, BIN  
AND STORAGE MODULE**

**I/N 3171292  
MODEL NO.  
BQ1081**

STYLISH INTEGRATED HANDLES

OUTDOOR SINK WITH MODERN FLICK TAP

LOCKING CASTORS AND STRAINING PLUG

BLACK GRANITE TOP

RUBBISH BIN

Premium #304 grade stainless steel cabinet

- **1** Interchangeable sink – top can be moved from left to right depending on your kitchen layout
- WELS Approved Hot and Cold Tap
- Supplied fully assembled
- 830mm W x 630mm D x 905mm H

# FRIDGE TOPS



 PLATINUM III  
2 DOOR BAR FRIDGE TOP

**I/N 3171308**  
MODEL NO.  
**BQ1046**

- 903mm W x 630mm D



 PLATINUM III  
1 DOOR BAR FRIDGE TOP

**I/N 3171307**  
MODEL NO.  
**BQ1045**

- 503mm W x 630mm D

The fridge tops have a stainless steel fascia with black granite top so that the fridge integrates perfectly into your Platinum III Outdoor Kitchen. The fridge top is also supplied with adjustable feet for your fridge to bring the height up to match your Platinum III Outdoor Kitchen.



# COMPLETES THE LOOK OF YOUR PLATINUM III OUTDOOR KITCHEN

FRIDGE TOP MODEL NO. BQ1046 - I/N 3171308



FRIDGE TOP MODEL NO. BQ1045 - I/N 3171307

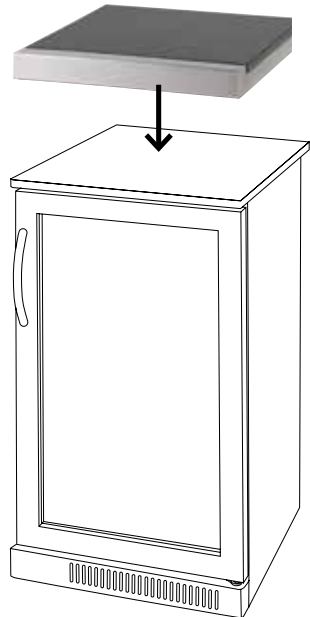

SUITS 2 DOOR FRIDGE I/N 3171042

SUITS 1 DOOR FRIDGE I/N 3171041



# TECHNICAL DIMENSIONS

## FOR PLUMBING AND CABINETRY



**PLATINUM III SINK DRAIN AND TAP CONNECTION**

**I/N 3171292  
MODEL NO.  
BQ1081**



**PLATINUM III BBQ's  
MINIMUM WALL CLEARANCE**

**BQ1080 +  
BQ1080B +  
BQ1080KIT**

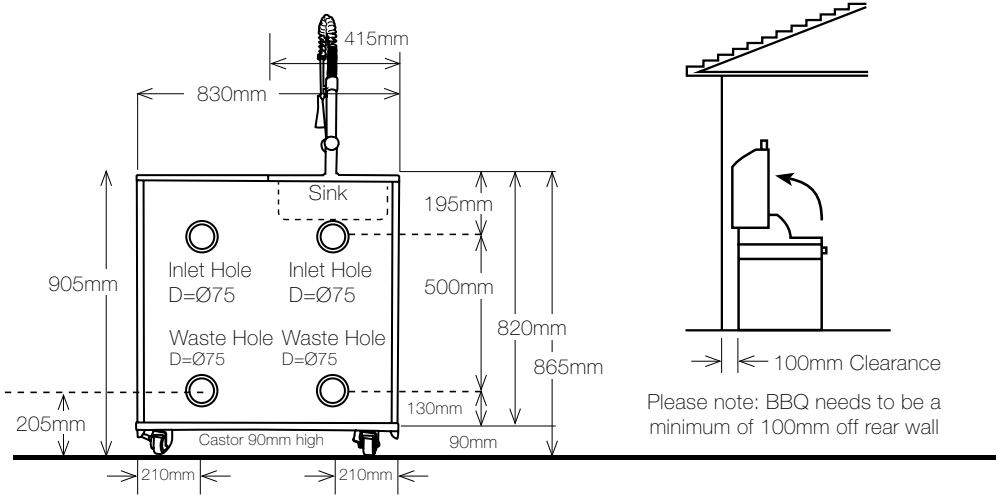

**PLATINUM III  
BUILT IN BBQ**

**I/N 3171291  
MODEL NO.  
BQ1080B**

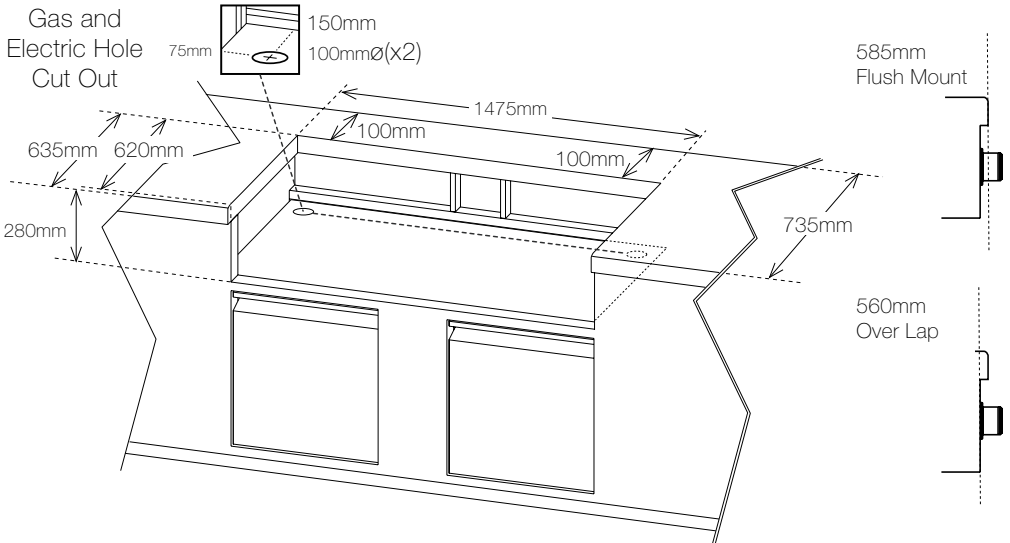



## OUTDOOR USE ONLY

The following situations are considered to provide the natural ventilation required for an outdoor domestic barbecue to be used:

- Four open sides with a roof or overhead cover.
- Four enclosed sides (walls) without a roof or overhead cover.
- Two parallel walls or two walls at right angles to each other with a roof or overhead cover.
- Three walls, with the one open side being at least 25% of the total perimeter and the remaining three walls having an area of 30 per cent or more of unrestricted opening, with a roof or overhead cover.

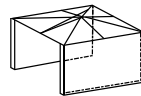

Parallel Walls

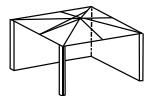

Right Angle Walls

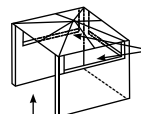

Open side at least 25% of total wall area

30% or more in total of the remaining wall area is open and unrestricted

**Gasmate**  
the outdoors made easy



Due to continual product development, the product you purchase may differ slightly from the ones shown here. Gasmate® is a registered trademark of Sitro Group Australia Pty. Ltd. [www.gasmate.com.au](http://www.gasmate.com.au)

03457 06/18