

Home power Lithium-Ion Battery Product Manual

(V1.0)



Shuangdeng Group Co., Ltd

This manual introduces SDA 10-48100 from Shoto. Please read this manual before you to install the battery and follow the instruction carefully during the installation process. Any confusion, please contact Shoto immediately for advice and clarification.

Contents

1. Safety Precautions	4
1.1、 Reminding	4
1.2 、 Warning	5
1.2.1、 Before Using	5
1.2.2、 In Using.....	5
2. Product advantages.....	5
3. Specifications	6
4. System panel instructions	7
4.1、 The main information of panel battery products as follows:	7
4.2、 Communication interface	8
4.2.1、 Cascade communication interface	8
4.2.2、 Communication wire	10
4.2.3、 CAN.....	11
4.2.4、 Power Terminals	11
4.2.5、 LED Status Indicators	12
4.2.5.4、 Flashing instructions	13
4.2.5.5、 Status indication	13
5. Safe handling of lithium batteries Guide	14
5.1、 Schematic Diagram of Solution	14
5.2、 Explanation of Symbol.....	14
5.3、 Tools	15

5.4、 NOTE	15
5.5、 Safety Gear	15
5.6、 Installation	16
5.6.1、 Package Items	16
5.6.2、 Installation Location	19
6. Trouble Shooting Steps.....	20
6.1、 Problem determination based on:.....	20
6.2、 Preliminary determination steps:.....	20
6.3、 The battery cannot be charged or discharged.....	21
7. Emergency Situations	21

1. Safety Precautions

1.1、 Reminding

1) It is very important and necessary to read the user manual carefully (in the accessories) before installing or using battery. Failure to do so or to follow any of the instructions or warnings in this document can result in electrical shock, serious injury, or death, or can damage battery, potentially rendering it inoperable.

2) It is strictly forbidden to immerse the battery in water or rain.

3) Prohibit using and shelving the battery beside the high temperature source.

4) Please use the module according to the charge and discharge parameters specified in this manual.

5) It is prohibited to connect the battery and AC power directly.

6) Forbid discarding the battery into fire or heater.

7) Forbid breaking up the battery and its part.

8) Forbid to rap, stomp and throw the battery.

9) Even if the grid is cut off, the battery module still has the voltage output, please take care to avoid electric shock or short circuit when using battery module.

10) If the battery is stored for long time, it is required to charge them every six months, and the SOC should be no less than 90%. Battery needs to be recharged within 12 hours, after fully discharged.

11) Do not expose cable outside.

12) All the battery terminals must be disconnected for maintenance.

13) Do not connect battery with PV solar wiring directly.

14) Please contact the supplier within 48 hours if there is something abnormal.

15) In areas with poor environmental conditions, effective protective measures must be taken for battery module, such as good grounding, sunshading board, rain cabinet and dust screen, to avoid lightning, rain, snow, high temperature, dust damage battery module and impact battery life.

16) For being used in high temperature areas, the battery must be used in cabinets with corresponding heat dissipation equipment (fans or air conditioners). In low temperature areas, the battery must be used in cabinets with corresponding heating equipment (heating plates or air conditioners). In coastal areas, the battery must be used in a cabinet with the corresponding salt spray protection capability.

17) Unless otherwise specified, the charging and discharging current for the battery module and battery module is recommended to be set at $0.5C_3$.

18) Please read the product manual carefully before installation and application, The warranty claims are excluded for direct or indirect damage due to items above.

1.2 、 Warning

1.2.1、 Before Using

- 1) After unboxing, please check product and packing list first, please read the product manual carefully before installation and application,if product is damaged or lack of parts, please contact with the local retailer;
- 2) It is prohibited to connect the battery and AC power directly;
- 3) Before installation, the cable must not be reversed and make sure the battery is in the turned-off mode;
- 4) Wiring must be correct, do not mistake the positive and negative cables, and ensure no short circuit with the external device;
- 5) The battery please DO NOT connect battery in series;
- 6) Battery system must be well grounded and the resistance must be less than 1 Ω ;
- 7) Please ensure the electrical parameters of battery system are compatible to related equipment;
- 8) Keep the battery away from water and fire.

1.2.2、 In Using

- 1) If the battery system needs to be moved or repaired, the power must be cut off and the battery is completely shutdown;
- 2) It is prohibited to put the batteries working with faulty or incompatible inverter;
- 3) In case of fire, only dry powder fire extinguisher can be used, liquid fire extinguishers are prohibited.
- 4) It is forbidden to connect the battery with different types of battery.

2. Product advantages

- 1) The battery positive electrode is made of LFP, which has long cycling life and good safety.
- 2) The battery module adopts the high-performance BMS, which has the protective functions of current, voltage and temperature etc..
- 3) The system can seamlessly turn on after the public electricity fails.
- 4) Adopting the self-cooling method, the system has extremely low noise.
- 5) Good temperature characteristics : working environment temperature can reach $-20\sim+50^{\circ}\text{C}$ (Charging $-5\sim45^{\circ}\text{C}$; discharging $-20\sim50^{\circ}\text{C}$, recommended temperature: $+15\sim+35^{\circ}\text{C}$).
- 6) LFP battery has excellent rate discharge performance, which enables LFP battery with small capacity to meet large current discharge requirements.

3. Specifications

Model	SDA10-48100
Nominal Capacity (kWh)	5.12
Depth of Charge	90%
Usable Capacity (Wh)	4.60
Charge Voltage (V)	54.0-56.4
Discharge Voltage (V)	45.0-48.0
Nominal Voltage (V)	51.2
Charge/Discharge Current(A)	Recommend 50 (0.5C)
	Max 100 (1C)
Communication Port	RS485 & CAN
Weight (Kg)	41 ±1 Kg
Dimensions (W*H*D)mm	442mm ±2mm*133mm ±2mm*420 ±2mm
Operating Temperature(°C)	Charge: -5°C~+45°C
	Discharge: -20°C~+50°C
Recommend Operating Temperature(°C)	Charge: +15°C~+35°C
	Discharge: +15°C~+35°C
	Storage: -20°C~+35°C
Humidity	5%-95%
Altitude	≤4000m

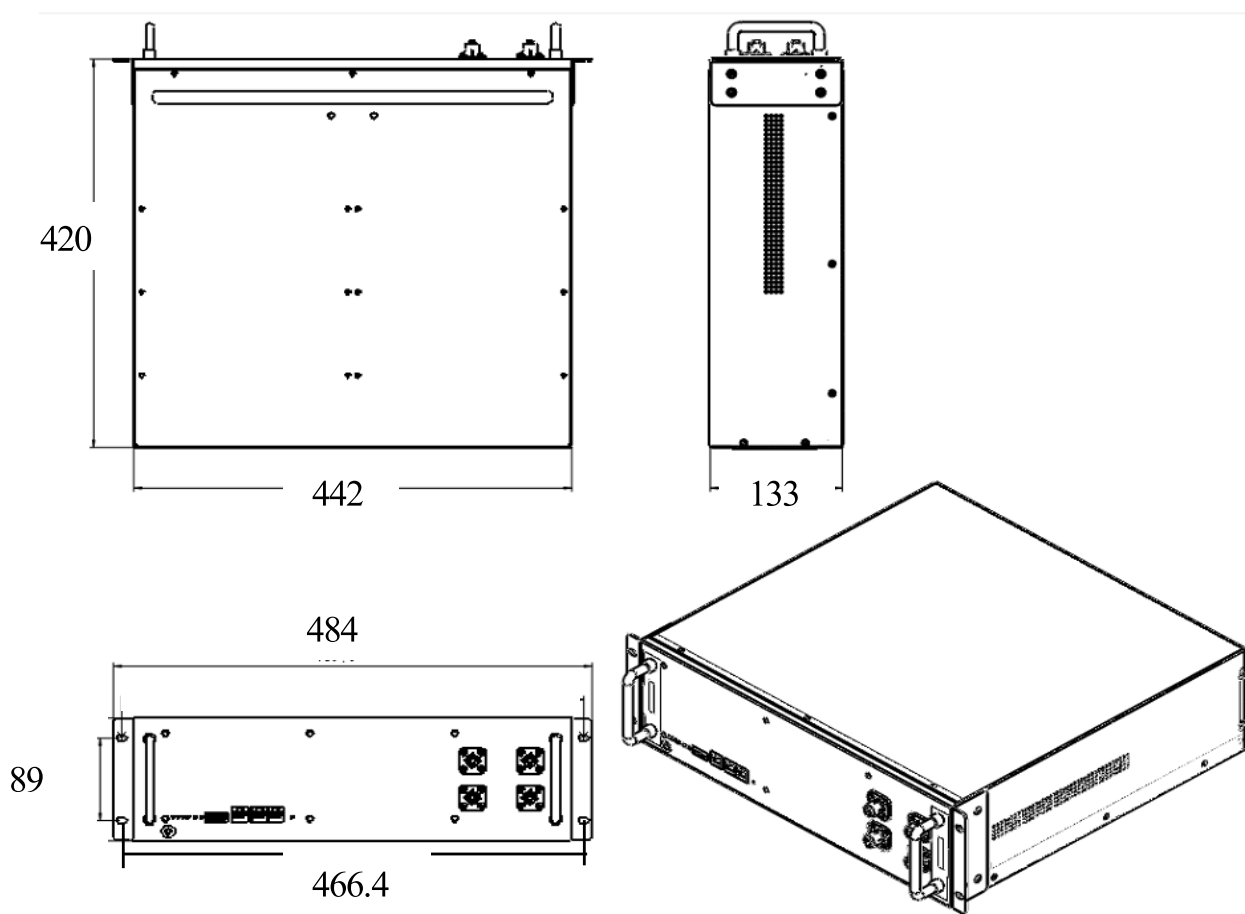

4. System panel instructions



Pic.1 SDA10-48100 Schematic of lithium iron battery system panel

4.1、The main information of panel battery products as follows:

Table 1 SDA10-48100 The main panel details of lithium iron battery system

Number	Designation	loge	Descriptions
1	Capacity indicator	SOC	4 green lights, green LEDs to show the battery's current capacity, each light indicates 25% capacity.
2	Stand by lamp	ALM	1 red light, red LED flashing to show the battery has alarm, and lighting to show the battery is under protection.

Number	Designation	loge	Descriptions
3	Communication running lights	RUN	1 green light ,running lights
4	ADD switch	ADD	Used to set the battery correspondence address
5	CAN communication port	CAN	CAN Communication Terminal: (RJ45 port) follow CAN protocol, for output batteries information
6	485A communication port	RS485A	Used to communicate with the computer PC or cascade communication
7	485B communication port	RS485B	Used to communicate with the computer PC or cascade communication
8	On-off key	RESET	Standby button, the duration is 3 seconds, the battery can be shut down; Turned off the key, the duration is 3 seconds, the battery can power on, power can be automatically activated battery system.
9	Input and output interfaces: anode	“-“	T wo way anode battery input and output
10	Input and output interfaces: cathode	“+“	T wo way cathode battery input and output
11	Grounding terminal		Used for battery grounding

4.2、Communication interface

4.2.1、Cascade communication interface

The number of “6”and“7” in Table 1 represents RS485 communication ports ,R485 Communication Terminal(RJ45 port) follow RS485 protocol, for output batteries information,RS485 definition is shown in Table 2-1.

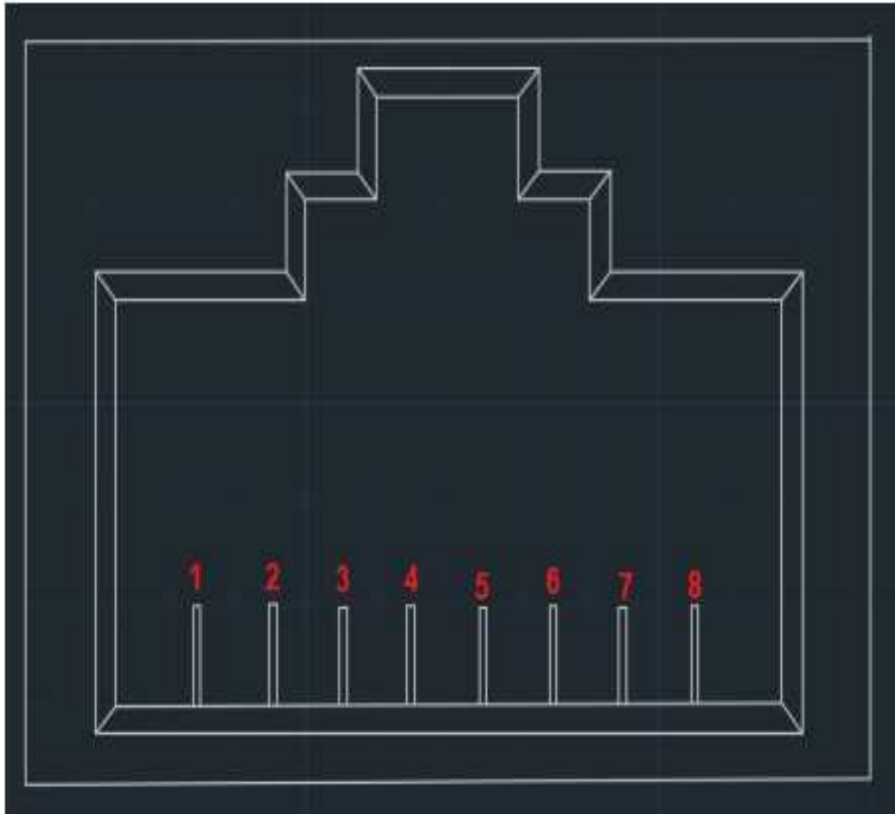
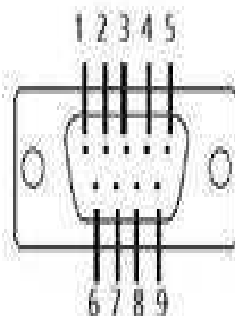

Table 2-1 The pins definition of the RS485 port

Pin	Definitions
1	RS485-B
2	RS485-A
3	GND
4	NC
5	NC
6	GND
7	RS485-A
8	RS485-B

Pic. 2 shows the communication wire with that of DB9 (first wire and sixth wire are not connected).



USB转RS485 (DB9) 线:

PIN1: RS485-A

PIN2: RS485-B

RS485-A : pin2/pin7

RS485-B : pin1/pin8

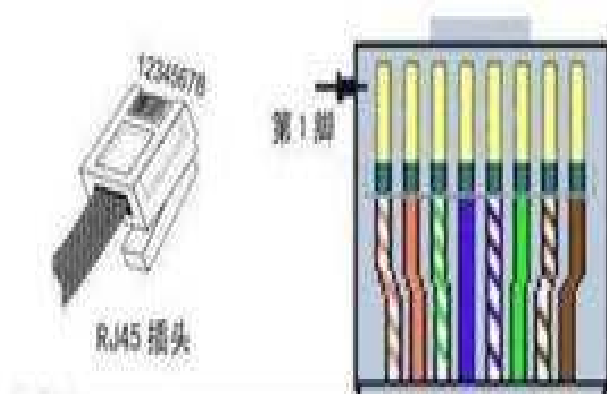

RS485 (DB9) 转RJ45

水晶头线:

PIN1: RS485-B

PIN2: RS485-A

4.2.2、Communication wire

Pic. 3 shows the cascade communication wire connections of RS485.

Host battery mouldle address

000001

slave battery mouldle

slave battery mouldle

slave battery mouldle

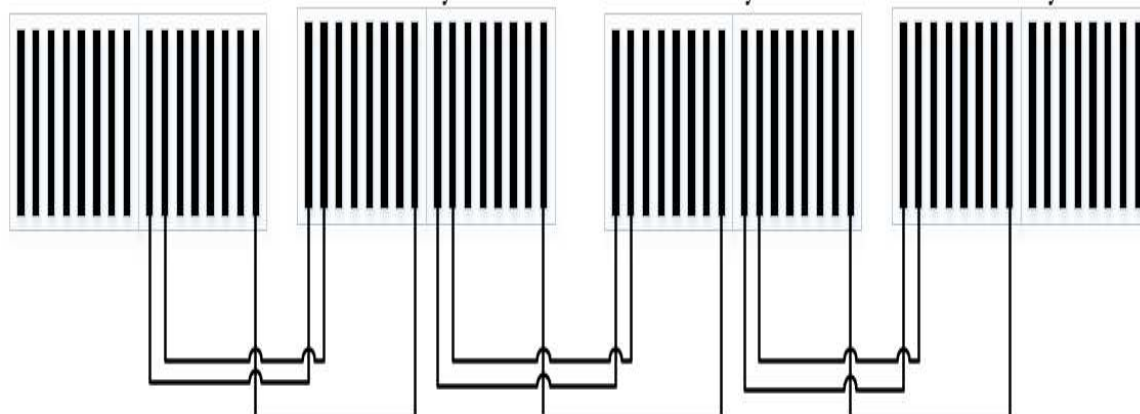

4.2.3、CAN

CAN Communication Terminal: (RJ45 port) follow CAN protocol, for output batteries information。

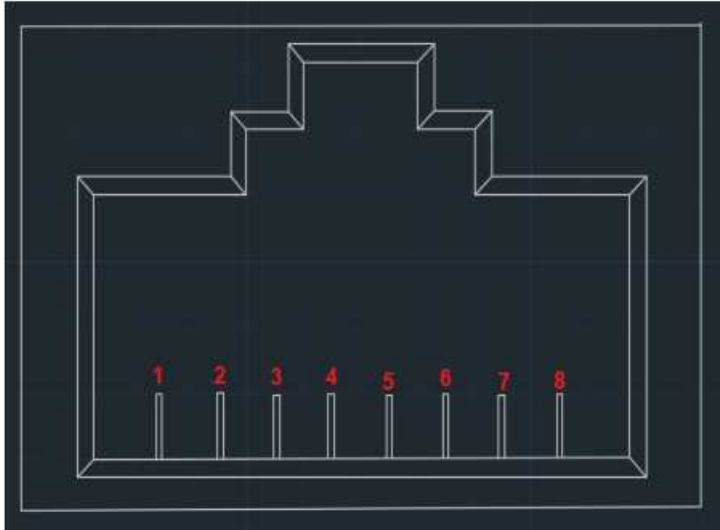
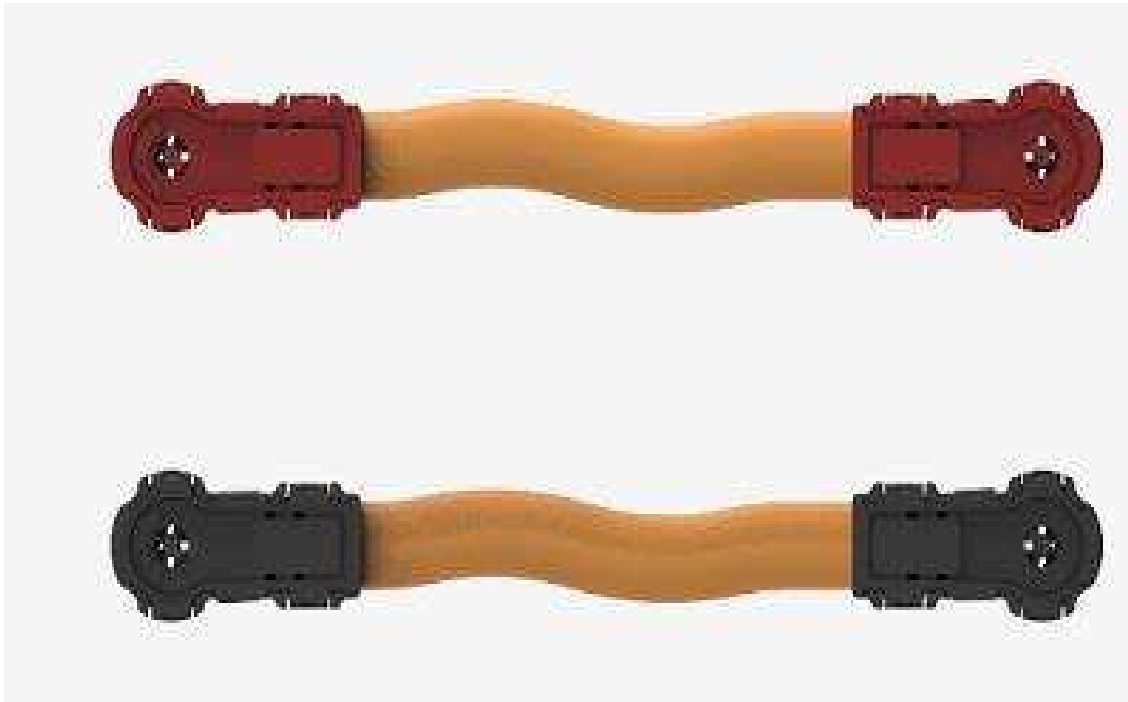

Table 2-2 The pins definition of the CAN port

Pin	Definitions
1	NC
2	NC
3	GND
4	CAN-L
5	CAN-H
6	GND
7	NC
8	NC

4.2.4、Power Terminals

Power cable terminals: there are two pair of terminals with same function, one connect to equipment, the other one paralleling to other battery module for capacity expanding. For each single module, each terminal can achieve charging and discharging function.



4.2.5、LED Status Indicators

4.2.5.1、LED lights order

1 RUN LED, 1 ALM LED, 4 SOC LED.

●	●	●	●	●	●
SOC				ALM	RUN

4.2.5.3、Capacity indicator

Statuses		Charge			
Capacity Light		L4 ●	L3 ●	L2 ●	L1 ●
SOC	0%~25%	OFF	OFF	OFF	Flash
	25%~50%	OFF	OFF	Flash	Light
	50%~75%	OFF	Flash	Light	Light
	75%~100%	Flash	Light	Light	Light
Run Light ●		Long lighting			

Statuses		Discharge			
Capacity Light		L4 ●	L3 ●	L2 ●	L1 ●
SOC	0%~25%	OFF	OFF	Light	Light
	25%~50%	OFF	Light	Light	Light

	50%~75%	Light	Light	Light	Light
	75%~100%	Light	Light	Light	Light
Run Light ●		Flashing			

4.2.5.4、Flashing instructions

Flashing way	Light	OFF
Flash 1	0.25s	3.75s
Flash 2	0.5s	0.5s
Flash 3	0.5s	1.5s

4.2.5.5、Status indication

System status	Operation status	SOC				ALM	RUN	Remark
		●	●	●	●	●	●	
Shut down	Dormancy	OFF	OFF	OFF	OFF	OFF	OFF	All OFF
Standby	Normal	Indicating according to actual capacity				OFF	Light	Standby
Charge	Normal	Indicating according to actual capacity				OFF	Light	The highest LED flash 2
	Over current alarm	Indicating according to actual capacity				Flash 2	Light	The highest LED flash 2
	Over voltage protect	OFF	OFF	OFF	OFF	OFF	Flash 1	
	Temperature and overcurrent protection	OFF	OFF	OFF	OFF	OFF	Flash 1	
Discharge	Normal	Indicating according to actual capacity				OFF	Flash 3	Indicating according to actual capacity
	Alarm	Indicating according to actual capacity				Flash 3	Flash 3	
	Temperature, over current, short circuit and other protection	OFF	OFF	OFF	OFF	Light	OFF	Stop discharging, power offline 48h after no action forced hibernation
	Low voltage protection	OFF	OFF	OFF	OFF	OFF	OFF	Stop discharging, all light off.

5. Safe handling of lithium batteries Guide

5.1、 Schematic Diagram of Solution

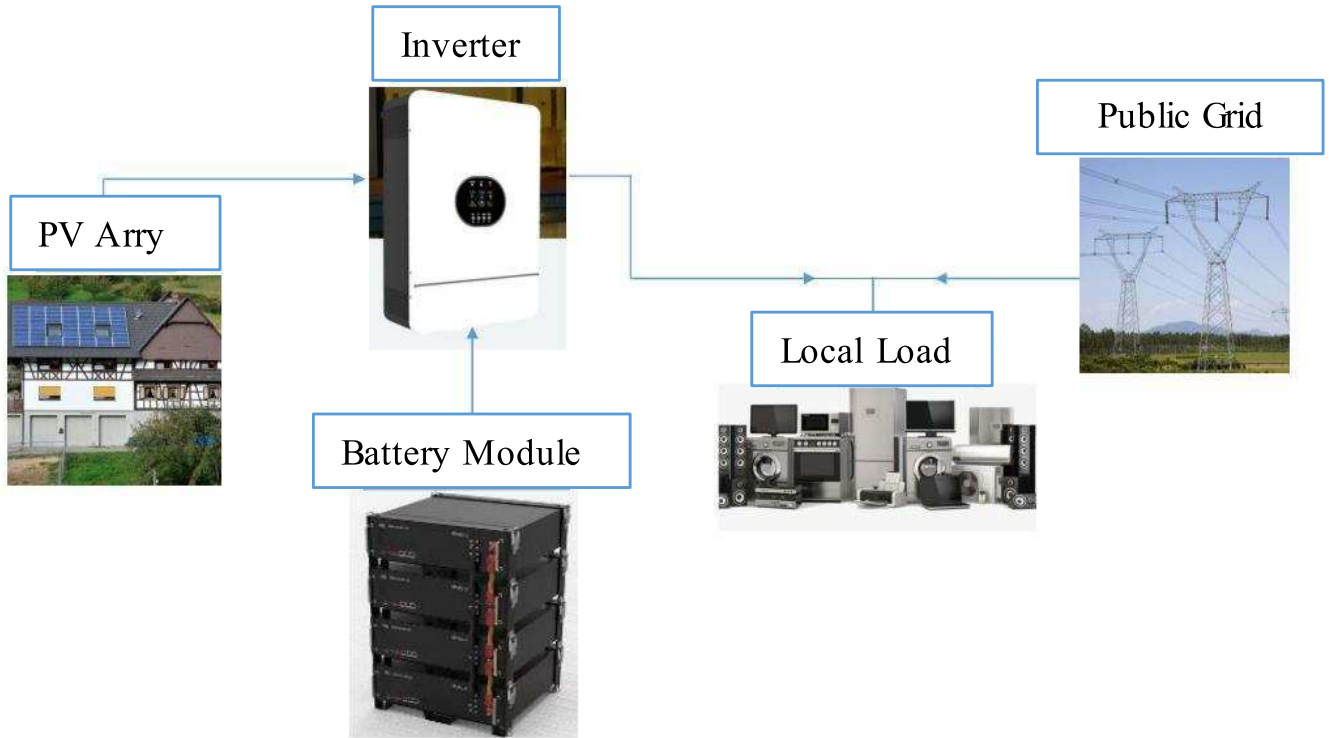

5.2、 Explanation of Symbol

DANGER

DANGER LOW DC VOLTAGE INSIDE
DANGER ARC FLASH & SHOCK HAZARD

- * Do not disconnect or disassemble by non-professional personnel.
- * Do not connect the battery pack output positive and negative ports reversely.
- * Do not drop, deform, impact, cut or spearing with a sharp object.
- * Do not place near open flame or flammable material.
- * Do not cover or wrap the product case.
- * Do not sit or put heavy things on battery.
- * Avoid of moisture or liquid.
- * Follow the product manual to make wiring connection.
- * Keep out of reach of children, animals or insects.
- * Contact your supplier within 24 hours if anything failure happens.

5.3、 Tools

The following tools are required to install the battery pack.



Wire cutter



Crimping Modular Plier



Screw Driver



style ammeter

5.4、 NOTE



Use properly insulated tools to prevent accidental electric shock or short circuits.

If insulated tools are not available, cover the entire exposed metal surfaces of the available tools, except their tips, with electrical tape.

5.5、 Safety Gear

It is recommended to wear the following safety gear when dealing with the battery pack.



Insulated gloves



Safety shoes



Safety goggles

5.6、 Installation

5.6.1、 Package Items

Unpacking and check the Packing List.

1) For battery module package:

Two power cables and one communication cable for each battery package:

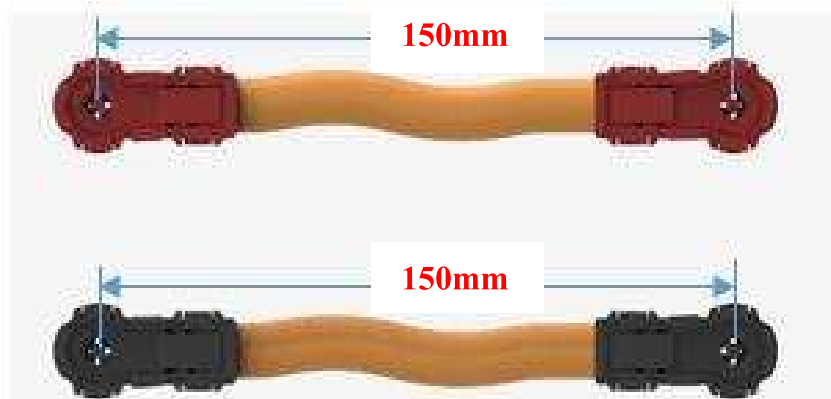

2) Grounding cable:

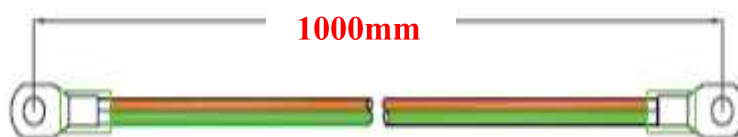

Grounding cables use 10AWG yellow-green cables.



Module grounding is based on metal directly touch between the module's surface and rack's surface. So it needn't grounding cables at all. If uses normal rack, it can remove the paint at the corresponding place. Or install a grounding cable to the grounding point of the modules.

3) For battery system connects to inverter:

(Need to be purchased separately, or specify separately when placing an order)

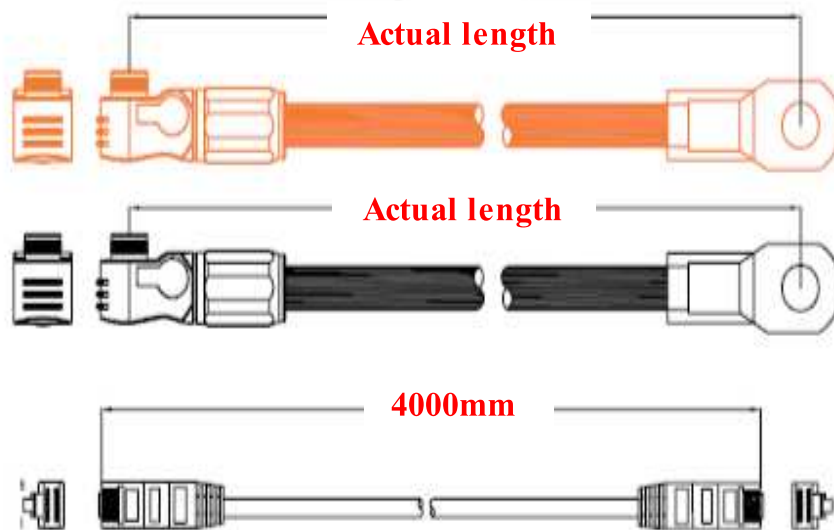

4) Two long power cables (current capacity 120A) and one communication cable for each energy storage system.

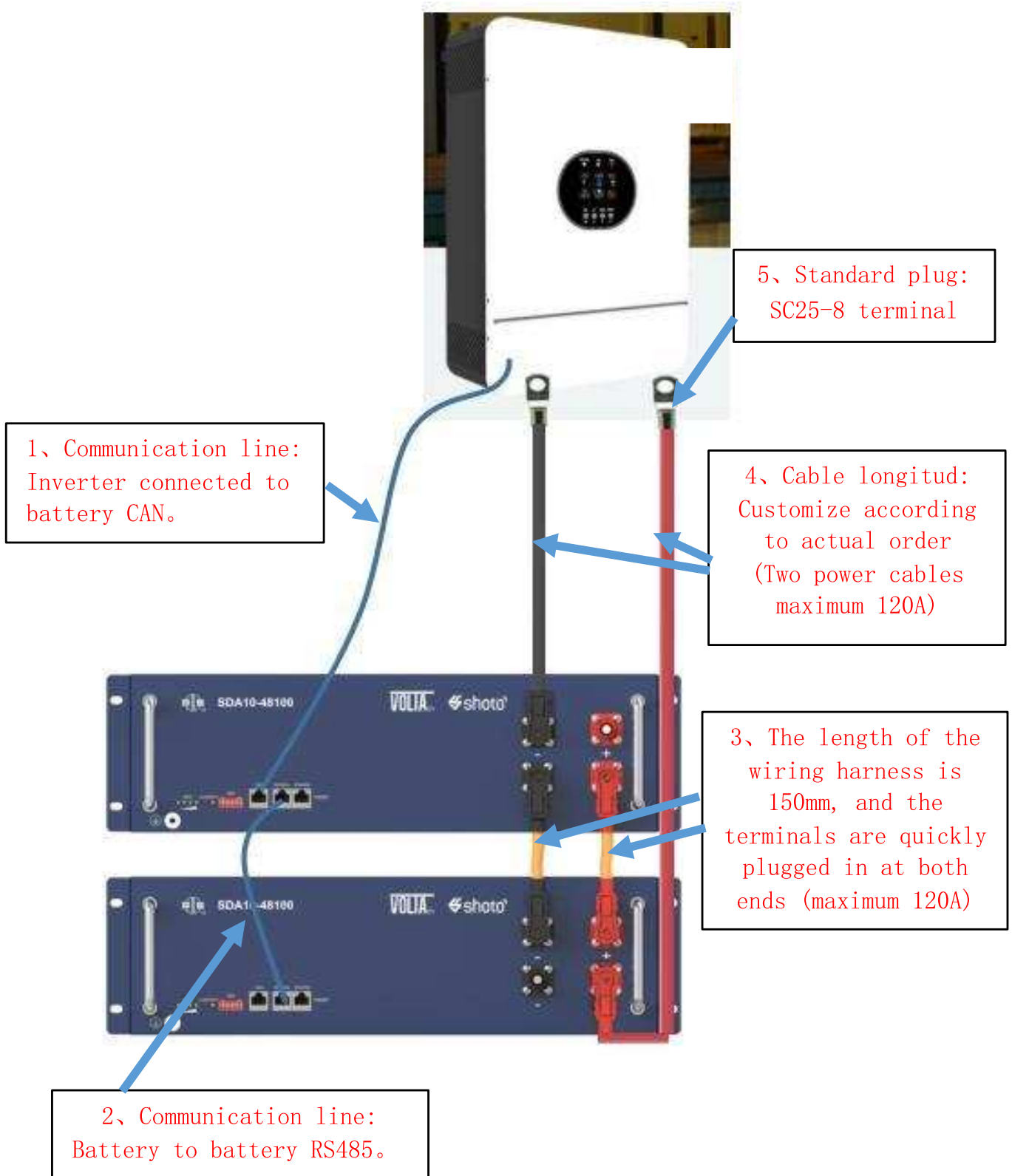

5) Adjust the ADD Switch as defined in the figure belowe.

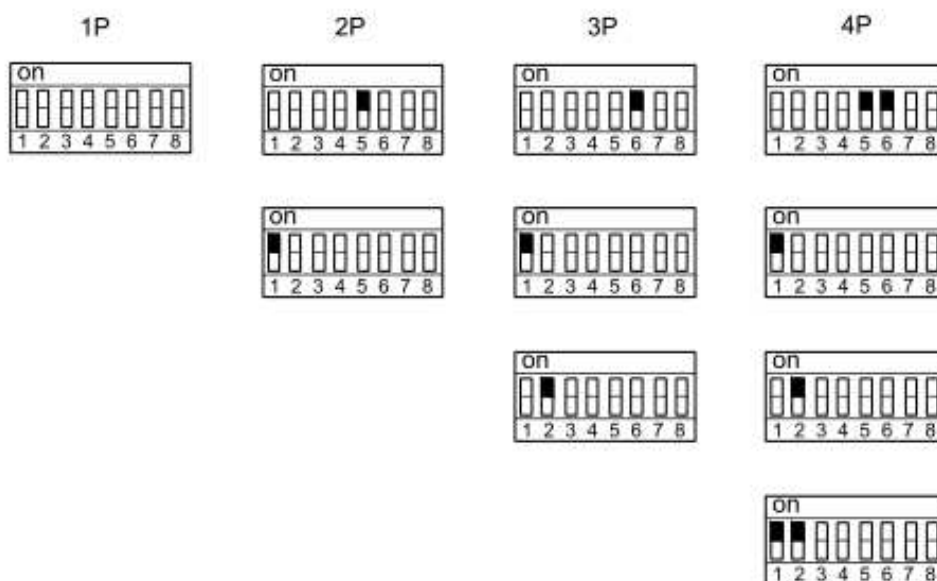

5.6.2、 Installation Location

Make sure that the installation location meets the following conditions:

- 1) The area is completely water proof. The floor is flat and level.
- 2) There are no flammable or explosive materials.
- 3) The ambient temperature is within the range from -5 °C to 45 °C.

The temperature and humidity is maintained at a constant level. There is minimal dust and dirt in the area.

- 4) The distance from heat source is more than 2 meters.
- 5) The distance from air outlet of inverter is more than 0.5 meters.

Do not cover or wrap the battery case or cabinet.

6) Do not place at a children or pet touchable area. The installation area shall avoid of direct sunlight.

7) There is no mandatory ventilation requirements for battery module, but please avoid of installation in confined area. The aeration shall avoid of high salinity, humidity or temperature.

8) CAUTION:

If the ambient temperature is outside the operating range, the battery pack stops operating to protect itself. The optimal temperature range for the battery pack to operate is 25 °C to 35 °C. Frequent exposure to harsh temperatures may deteriorate the performance and life of the battery pack.

6. Trouble Shooting Steps

6.1、 Problem determination based on:

- 1) Whether the battery can be turned on or not;
- 2) If battery is turned on, check the red light is off, flashing or lighting;
- 3) If the red light is off, check whether the battery can be charged/discharged or not.

6.2、 Preliminary determination steps:

- 1) Battery cannot turn on, switch on the lights are all no lighting or flashing.

If the battery RESET switch is turned on, the RUN light is flashing, and the external power supply voltage is 48V or more, the battery still unable to turn on, please contact distributor.

- 2) The battery can be turned on, but red light is lighting, and cannot charge or discharge. If the red light is lighting, that means system is abnormal, please check values as following:

- a) Temperature: Above 45°C or under -5°C, the battery could not work.

Solution: To move battery to the normal operating temperature range between -5°C and 45°C.

- b) Current: If current is greater than 100A, battery protection will turn on.

Solution: Check whether current is too large or not, if it is, to change the settings on power supply side.

- c) High Voltage: If charging voltage above 54V, battery protection will turn on.

Solution: Check whether voltage is too high or not, if it is, to change the settings on power supply side.

- d) Low Voltage: When the battery discharges to 40.0V or less, battery protection will turn on. Solution: Charge the battery for some time, the red light turn off.

Excluding the four points above, if the faulty is still cannot be located, turn off power switch of the battery and repair.

6.3、 The battery cannot be charged or discharged

1) Cannot be charged:

Disconnect the power cables, measure voltage on power side, if the voltage is 50~53.5V, restart the battery, connect the power cable and try again, if still not work, turn off battery and contact distributor.

2) Unable to discharge:

Disconnect the power cables and measure voltage on battery side, if it is <40.0V, please charge the battery; if voltage is above 48V and still cannot discharge, turn off battery and contact distributor.

7. Emergency Situations

1) Leaking Batteries

If the battery pack leaks electrolyte, avoid contact with the leaking liquid or gas. If one is exposed to the leaked substance, immediately perform the actions described below. Inhalation: Evacuate the contaminated area, and seek medical attention.

Contact with eyes: Rinse eyes with flowing water for 15 minutes, and seek medical attention.

Contact with skin: Wash the affected area thoroughly with soap and water, and seek medical attention.

Ingestion: Induce vomiting, and seek medical attention.

2) Fire

NO WATER! Only dry powder fire extinguisher can be used; if possible, move the battery pack to a safe area before it catches fire.

3) Wet Batteries

If the battery pack is wet or submerged in water, do not let people access it, and then contact Shoto or an authorized dealer for technical support.

4) Damaged Batteries

Damaged batteries are dangerous and must be handled with the utmost care. They are not fit for use and may pose a danger to people or property. If the battery pack seems to be damaged, pack it in its original container, and then return it to Shoto or an authorized dealer.

NOTE