

“  
*Where sun shined  
Power always on*  
”



# USER MANUAL

LXP 3K/4K/4K6/5K Hybrid

Installation

Connection

Commissioning

Operation and Maintenance guidance



# CONTENTS

■	<b>About This Manual</b>	<b>01</b>		
I	<b>Safety</b>	<b>02</b>		
	1.1 Symbol Explanation	02		
	1.2 Safety Instruction	03		
2	<b>Brief Introduction</b>	<b>05</b>		
	2.1 System Solution	05		
	2.2 Product Description	06		
3	<b>Pre-Installation</b>	<b>07</b>		
	3.1 Unpacking & Storing	07		
	3.2 Product Overview	09		
	3.3 Select Location	13		
	3.4 Clearance Requirements	15		
	3.5 Tools & Materials	16		
4	<b>Installation</b>	<b>17</b>		
	4.1 Install the Inverter	17		
	4.2 Install the Meter	18		
5	<b>Connection</b>	<b>19</b>		
	5.1 Connection Overview	19		
	5.2 PV Connection	20		
	5.3 Battery Connection	21		
	5.4 Grid Connection	23		
	5.5 EPS/Back-up Connection	25		
	5.6 Meter and CT Connection	26		
	5.7 Communication Connection	28		
	5.7.1 Battery RS485/CAN Connection	28		
	5.7.2 Meter RS485/CT Connection	30		
	5.7.3 DRM Connection	33		
	5.7.4 Safety Standard Configuration - SW2	35		
	5.7.5 Balancing Resistor Configuration - SW1	36		
	5.7.6 Wireless Communication Module Connection	37		
	5.8 Grounding	38		
6	<b>Operation Guide</b>	<b>39</b>		
	6.1 LCD Menu Structure Overview	39		
	6.2 LCD Operation & Setting Guidance	41		
	6.2.1 Information Searching	41		
	6.2.2 Setting Guidance	43		
	6.3 Inverter Working Status	48		
	6.4 System Working Modes	53		
	6.4.1 Self Use	53		
	6.4.2 Force Time Use	55		
	6.4.3 Export Control	55		
	6.4.4 EPS/Back-up/Off-grid	56		
	6.5 Start-up / Shut-down / Restart the Inverter	57		
	6.5.1 Start-up the Inverter	57		
	6.5.2 Shut-down the Inverter	57		
	6.5.3 Restart the Inverter	57		
7	<b>Commissioning</b>	<b>58</b>		
	7.1 Inspection	58		
	7.2 Commissioning Procedure	58		
8	<b>Troubleshooting &amp; Maintenance</b>	<b>59</b>		
	8.1 Troubleshooting	59		
	8.1.1 Introduction to LED Display	59		
	8.1.2 Troubleshooting Based On LCD Display	59		
	8.2 Maintenance	61		
9	<b>Decommissioning</b>	<b>62</b>		
10	<b>Specification</b>	<b>63</b>		

# About This Manual

## Target Group

This Manual is only intended for qualified electricians who are responsible to the installation, commissioning and decommissioning of the inverter and system.

## How to Use This Manual

This manual is one of the most important part in the package of the inverter which describes the installation, connection, commissioning and maintenance etc. of the inverter. Please read the manual and related documents carefully before any work on the inverter is carried out.

The user or qualified operator should keep this manual stored carefully and accessible at any time. Once lost this manual for some reason, the soft copy can be download from the official website of Lux Power Technology or emailed from the service department of LPT.

## Scope of Validity

This manual is applicable to following models of inverter from Lux Power Technology Co., Ltd:

- LXP 3K Hybrid
- LXP 4K Hybrid
- LXP 4K6 Hybrid
- LXP 5K Hybrid

# I. Safety

## I.1 Symbol Explanation









### Symbols in This Manual

The general information and safety instruction is highlighted with following symbols in this manual:

	“Danger” indicates a hazardous situation which, if not avoided, will result in death or serious injury.
	“Warning” indicates a hazardous situation which, if not avoided, could result in death or serious injury.
	“Caution” indicates a hazardous situation which, if not avoided, could result in minor or moderate injury.
	“Notice” provides tips that are valuable for the optimal operation of your products.

### Symbols on Inverter Label

Following list shows the meaning of all the safety symbols on inverter type label:

	CE Mark
	RCM Mark
	Certification
	Beware of hot surface. The inverter can be hot during operating, avoid contact during operating.
	Danger of high voltage. Danger to life due to the high voltages in the inverter.
	Risk of electric shock.
	Observe enclosed documentation.
	Danger of high voltage. Residual voltage in the inverter need 5min to discharge, wait 5min before operation.

## 1.2 Safety Instruction

### General Safety Instructions

The inverter has been designed and tested strictly according to international safety regulations. Read all safety instructions carefully prior to any work and observe them at all times when working on or with the inverter. The operator must be qualified personnel and the installation must be capable with relevant national or international standards or regulations.

Incorrect operation or work may cause:

- injury or death to the operator or a third party; or
- damage to the inverter and other properties belonging to the operator or a third party.

### Important Safety Notifications

There are many safety issues need to be carefully notified before, during and after the installation, and also in future operation and maintenance, following is important safety notifications to operator, owner and user of this product in appropriate usage.

#### **DANGER** Dangers of High Voltages and Large Current

- **Beware of high PV** voltage. Please turn-off the DC switch of PV Panel output before and during the installation to avoid electric shock
- Beware of high grid voltage. Please turn-off the AC switch of grid connection before and during the installation to avoid electric shock
- Beware of large current of the battery output. Please turn-off the battery module before and during the installation to avoid electric shock
- Do not open the inverter when it's working to avoid electric shock and damages from live voltage and current from the system.
- Do not operate the inverter when it's working, only the LCD and buttons can be touched in limited cases by qualified personnel, other parts of the inverter can be touched when the inverter is under a safe state(e.g. fully shut-down).
- Do not connect or disconnect any connections (PV, battery, grid, communication etc.) of the inverter when it's working.
- Make sure the inverter is well grounding, an operator should make sure itself is good protected by reasonable and professional insulation measurements (e.g. personal protective equipment (PPE)).
- Inspect relevant existed wiring on-site of the installation is under good condition before installation, operation or maintenance.
- Inspect the connections are good between inverter and PV, battery and grid during installation to prevent damages or injuries caused by bad connections.

#### **WARNING** Avoid misoperation and Inappropriate Usage

- **All the work of this product** (system design, installation, operation, setting and configuration, maintenance etc. must be carried out by qualified personnel as required.
- All connections must be in accordance with local and national regulations and standards.
- Only when permitted by utility grid, the inverter and system can interconnected with the utility grid.

#### **WARNING** User's Safety

- **All the warning table** or nameplate on the inverter must be clearly visible and must not be removed, covered or pasted.
- The installation should choose a right position and location as required in this manual with consideration to safety of users' in future operation.
- Please keep the children away from touching or misoperating the inverter and relevant system.

#### **WARNING**

- **Beware of burning** hurt, the inverter and some parts of the system could be hot when working, please do not touch the inverter surface or most of the parts when they are working. During inverter working states, only the LCD and buttons could be touched.

#### **CAUTION**

- **Only qualified personnel** can change the inverter settings.
- There might be possible damage to health as a result of the effects of radiation, do not stay closer than 20cm to the inverter for long time.

#### **NOTICE**

- **Please carefully read** this manual before any work carried out on this inverter, after the installation, please keep this manual carefully stored and easy to access at any time.
- The qualified personnel should have had training in the installation and commissioning of the electrical system as well as dealing with hazards, also they should have the knowledge of the manual and other related documents. As the installer or operator they are required to be familiar with local regulations and directives.

## 2. Brief Introduction

### 2.1 System Solution

This product and relevant system is suitable for following system applications (system diagram):

#### A. Solar and energy storage hybrid system



#### B. Energy storage system without solar



#### C. On-grid solar system without battery (hybrid ready)



#### D. Usage in retrofitting solar energy storage system



#### E. Off-grid and back-up applications



## 2.2 Product Description

The LXP series hybrid inverter is design to meet the demands of solar and energy storage system applications in different situations. As a single phase small sized hybrid inverter with EPS output and seamless handover functions etc., LXP series perfectly meet the requirements of both on-grid and off-grid solar and energy storage applications, or even as a uninterrupted EPS sources in some strictly situations.

### Standards and Certificates

- AS4777,
- VDE-AR-N4105, VDE0126,
- G83, G59,
- IEC62109-1-2, IEC62040, EN61000-6-1, EN61000-6-2, EN61000-6-3

### 3. Pre-Installation

There are series of works need to be done as a preparation of installation.

#### 3.1 Unpacking & Storing

The LXP inverter and its packaging is strictly checked before delivery from the factory, however in case of the possible damages during shipping, it's still recommended to our user to check and inspect the inverter and its package before they carry out relevant works.

- Check the packaging for any possible damages.
- Check the internal aspects for any possible damages.
- Check the completeness of packaging list for any missing parts.

Please directly contact the distributor or LXP for supports if there is any damage or missing components occurred.

#### Packaging Overview

The LXP inverter packaging is overall the same for the inverter series mentioned in this manual, the packaging overview shows below:

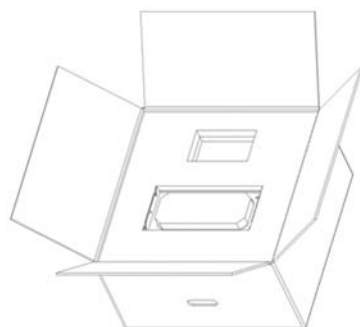

Width (mm)	Height (mm)	Depth (mm)
560	645	315

#### Packaging List

When the packaging is unpacked, the inner components should be the same as described in below packaging list.

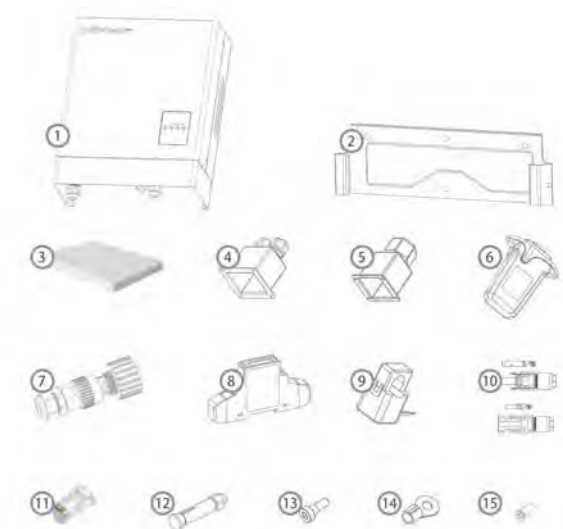

No.	Items	Qty	Remarks
1	Hybrid Inverter	1 pcs	Protective shell installed
2	Wall-mounted Bracket	1 pcs	
3	User Manual	1 pcs	
4	Battery Port Cover	1 pcs	
5	Communication Port Cover	1 pcs	
6	Wi-Fi Module	1 pcs	
7	AC Connector	2 set	Grid & EPS Connectors
8	Meter	1 pcs	
9	CT	1 pcs	Optional
10	PV Connector	2 set	
11	RJ45 Terminal	5 pcs	
12	Expansion Screw and Tube	4 set	
13	Security Screw	2 pcs	
14	OT Terminal	2 pcs	
15	Cross Head Screw	10 pcs	

### Storing the Inverter

The inverter must be stored appropriately if not installed immediately, refer to below figure.

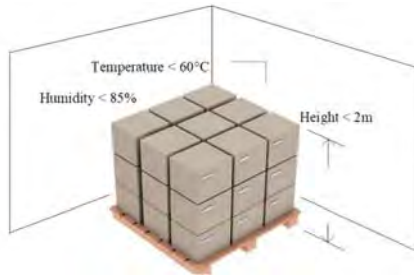

**CAUTION**

- The inverter and its components must be stored in its original packaging.
- The storage temperature should be within -25~60°C and the humidity within 0~85%
- The packaging should be upright
- The maximum stacked layers is 6.
- Do not exposed the inverter and its packaging to directly sunshine
- Do not exposed the inverter and its packaging to raindrops
- Keep the inverter and its packaging away from corrosion.

## 3.2 Product Overview

### Inverter Overview

The inverter appearance is shown in below figure as a reference.

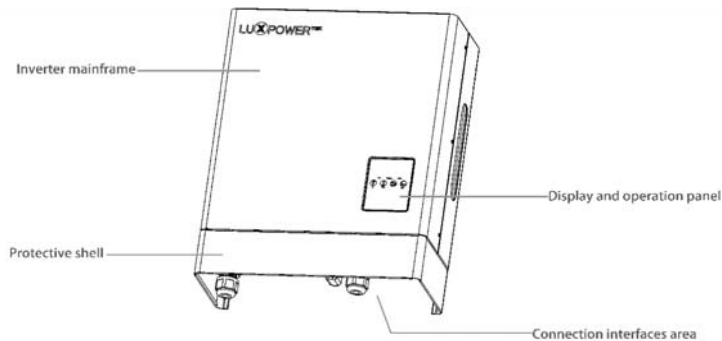

The inverter dimension is shown in below figure as a reference.

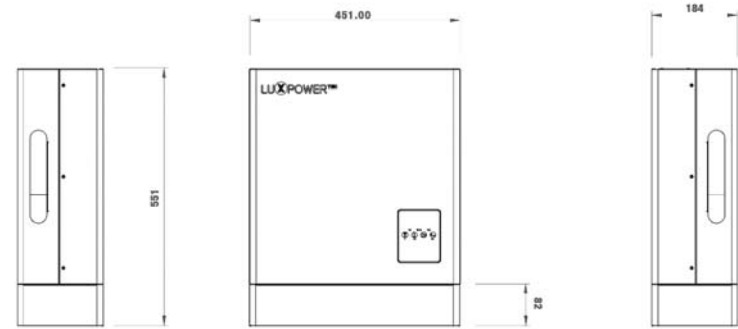

Bottom area and all the interfaces is shown in below figure as reference.

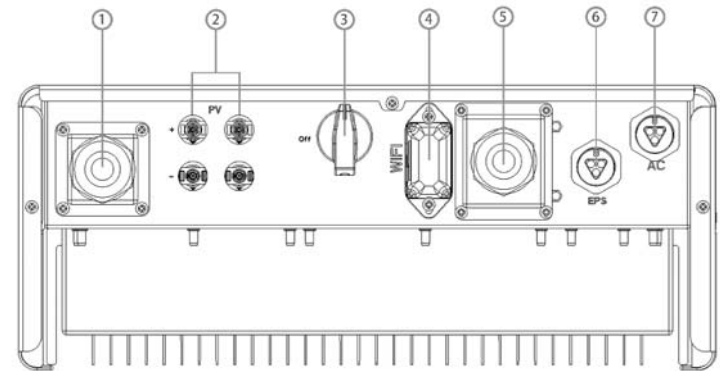

No.	Items	Remarks
1	Battery Connect Interface	
2	PV Input Interfaces	
3	DC Switch	
4	Wi-fi Module Interface	External Wi-Fi Module
5	Communication Interfaces Area	Including several Com ports
6	EPS Output Interface	
7	AC Output Interface	Grid Connection

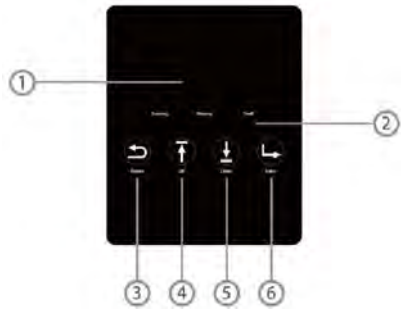

No.	Items
1	LCD Display
2	Running LED Indicator
	Warning LED Indicator
	Fault LED Indicator
3	Return Touch Button
4	UP Touch Button
5	Down Touch Button
6	Enter Touch Button

**Meter/CT Overview**

**A) Meter Overview**

The meter appearance and dimensions is shown in below figure as reference.

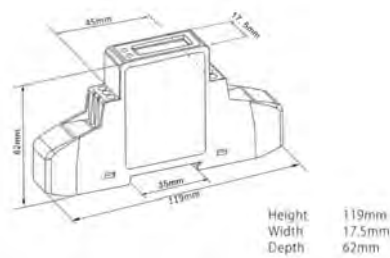

No.	Function Pin	Remarks
1	Line Input	Input of internal current sensor
2	Line Output	Output of internal current sensor
3	NE	56
4	NE	32
5	Pulse 1 out +	35
6	Pulse out -	
7	Pulse 2 out +	
8	RS485 GND	
9	RS485 B	
10	RS485 A	

**Pulse Output Connection**

Pulse output must be fed as shown in the wiring diagram right-side.

Scrupulously respect polarities and the connection mode.

Opto-coupler with potential-free SPST-NO Contact.

Contact range: 5~27 Vdc Max.

Current input: 27 mAdc

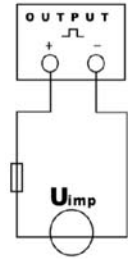

**Meter Specification**

Model	SDMI20 Modbus Pin
Nominal Voltage (Un)	120 V.a.c or 230 V.a.c
Operational Voltage	80% ~ 120% of Un
Basic Current (Ib)	5A
Maximum Rated Current (Imax)	45A
Operational Current Range	0.4% Ib - Imax
Over Current Withstand	30 Imax for 0.01s
Pulse Output	1000imp/kWh
International Standard	IEC 62053-21 / EN50470-1/3
Accuracy Class	Class I / Class B
Installation Category	CAT II
Mechanical Environment	M1
Electromagnetic Environment	E2
Degree of Pollution	2
Ingress Protection Degree	IP51 (indoor)
Voltage Current Accuracy	0 - 5%
Frequency Accuracy	0 - 2% of mid-frequency
Power Factor Accuracy	1% of utility (0.01)
Active&Apparent Power	± 1% of range maximum
Reactive Power Accuracy	± 1% of range maximum
Active Energy	Class I
Ingress Protection Degree	Class 2



## B) CT Overview - Optional

The CT (optional) appearance is shown in below figure as reference.



<b>Model</b>	<b>ESCT-T24-I</b>
<b>Frequency</b>	50~60Hz mid-frequency
<b>Rated Current</b>	100A
<b>Accuracy</b>	Class 1.0 maximum
<b>Phase Angle</b>	Less than 2 degrees at 50% of rated current
<b>Maximum Primary Voltage</b>	5000V.a.c (insulated conductor)
<b>Operating Temperature</b>	-15 to 60°C
<b>Operating Humidity</b>	<85%
<b>Case Material</b>	PC / UL94 - V0

## 3.3 Select Location

The LXP hybrid inverters are designed as IP65 devices with a capability to be installed in both outdoor and indoor conditions. However, selecting an optimal installation location is highly recommended to increase the safety, performance and lifespan of the inverter.

### Suggestions and Requirements

- a) The wall for mounting should be strong enough to bear the weight of the inverter during system's service time period.
- b) The wall for mounting should be suitable with the dimension of the inverter during system's service time period.
- c) Please make sure the wall thickness is over 70mm
- d) The install should not be accessible to children for safety consideration.
- e) The ambient temperature is required to be within -25°C ~ 60°C.
- f) To ensure the heat dissipation efficiency and inverter lifespan, do not install the inverter enclosed.
- g) The structure of the wall where inverter mounted should not be flammable, or make sure the inverter is not surrounded by flammable or corrosion materials and is away from the gas.

- h) Never install the inverter exposed to directly sunshine, rain and snow. Please refer to below figure and select a well shaded place or install a shell to protect the inverter from directly sunshine, rain and snow etc.



- i) The inverter should be installed vertically on the wall, or lean back on plane with a limited tilted angle. Please refer to below figure.

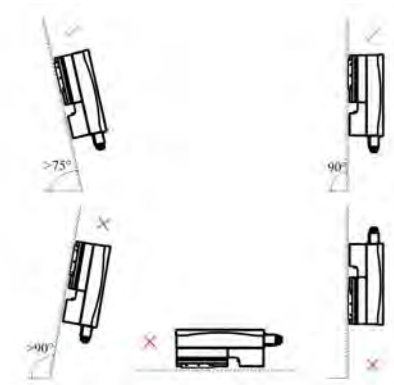

- j) Do not install the inverter in living area.
- k) Do not install the inverter near TV antenna or other antenna or antenna cables.
- l) Make sure there are enough space of the location for easy access to the inverter, relevant connection points and switches in future operation and maintenance.
- m) The height of installation should be reasonable to make sure easy operation and view the display of the inverter.

**⚠ DANGER**

In order to prevent any electric shocks or other injuries, please make sure there are no electricity, plumbing or gas pipeline in the wall where selected to drilling holes for installation

### 3.4 Clearance Requirements

To ensure the inverter working normally and easy to operate, there are requirements on available spaces of the inverter, e.g. to keep enough clearance. Refer to below figure.

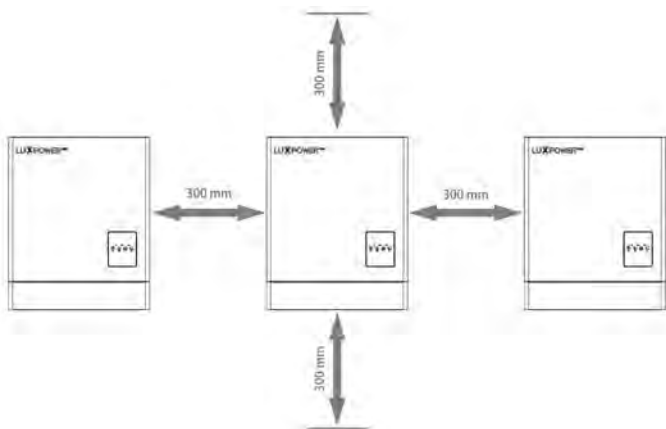

#### NOTICE

When multiple install the inverters in one location, to optimize the installation and increase performance and safety of system, it's recommended to always follow below instructions when install inverters. Refer to below figure.

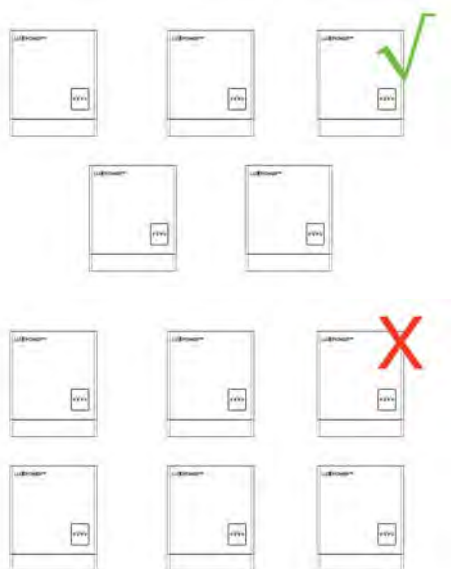

### 3.5 Tools and Materials

In the installation, following tools and materials are needed, please make preparation in advance before install.

#### A) Tools



No.	Tool Name	Remarks
1	Mark Pen	Mark the screwing position
2	Spanner	
3	PV Connector Uninstall Tool	To uninstall the PV connector
4	Screw Driver	
5	Wire Crimpes	To assemble the PV connectors
6	Crimping Modular Plier	To assemble the RJ45 Line
7	Wire Cutter	
8	Electric Drill	
9	Hammer	
10	Line Tester	To test the RJ45 Line

#### B) Safety Gear



## 4. Installation

### 4.1 Install the Inverter

The inverter is wall-mounted installed, steps shows below:

**Step1:** Install the wall-mounting bracket.

- a) Use the wall-mounting bracket as the template to mark the position of the 4 holes, then drill 4\*5M holes and make sure the depth of the holes is deeper than 50mm.

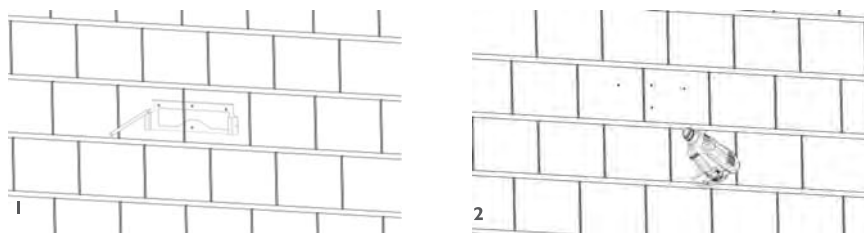

- b) Install the expansion tubes into the holes and tight them, then use the expansion screws (packaged together with the expansion tubes) to install and fix the wall-mounting bracket on the wall.

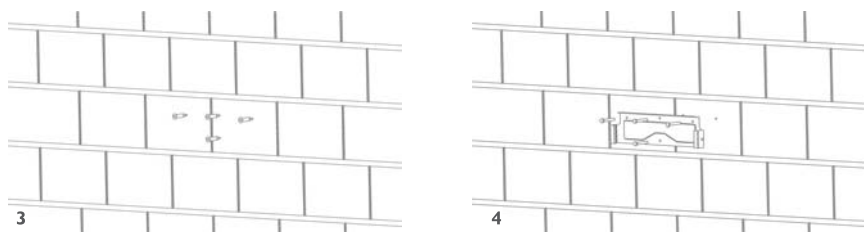

**Step2:** Install the inverter on the wall-mounting bracket and lock the inverter using the security screws.

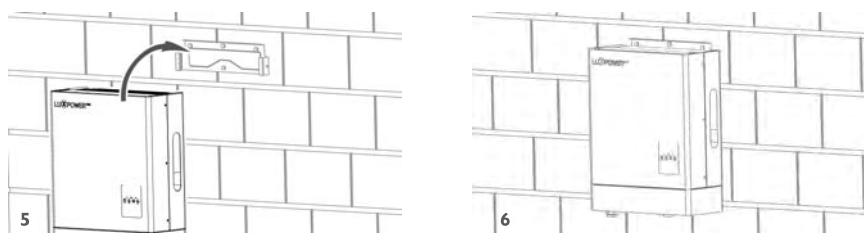

#### CAUTION

To prevent potential damages and injuries from inverter falling down, please carefully hang the inverter on the bracket, don't loosen grip unless confirm the inverter is well mounted.

**Step3:** Prepare for connections. Uninstall the protective shell from the inverter before making any connection works.

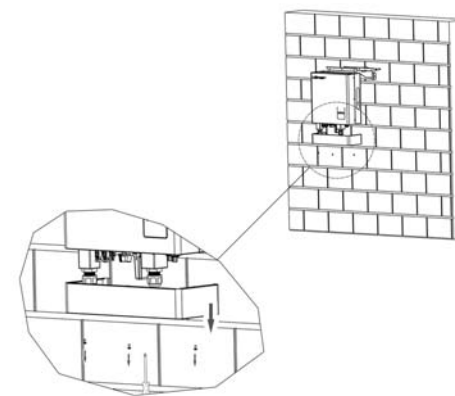

### 4.2 Install the Meter

meter support 35 DIN-rail installation, and should be installed between load and the grid.

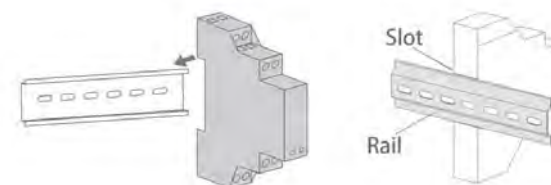

# 5. Connection

This part is mainly shows the steps to correctly connect LXP hybrid inverter.

**⚠ DANGER High voltage might cause damages and injuries.**

- Make sure the all cables are not live before connection
- Turn off the DC and AC switch during connection
- Take measurements of insulation of operators by wearing person protective equipment (PPE)
- Don't make any connection work when hands wet.
- Don't turn on the AC switch unless all the connection is completed.

**⚠ WARNING**

Make sure all the cables and connections are well connected with firmly attached, undamaged, property insulated and adequately dimensioned.

**⚠ CAUTION**

Only qualified personnel can make the connection works.

**● NOTICE**

All electrical connections must be in accordance with local and national standards and regulations.

## 5.1 Connection Overview

Comprehensive System Connection Diagram:

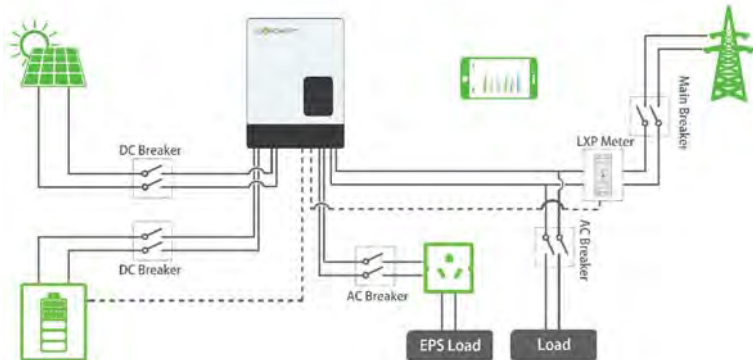

## Connection Terminals and Interfaces Overview

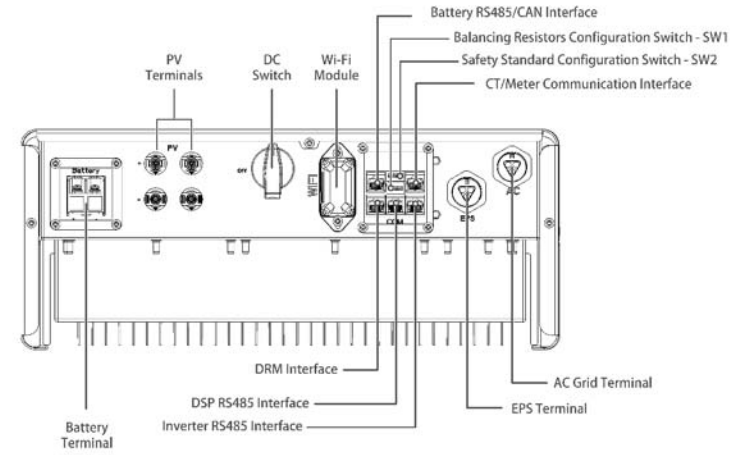

## 5.2 PV Connection

The PV connection of LXP hybrid inverter is the same to traditional on-grid solar inverter (string inverter).

**● NOTICE**

- Before connection the PV, please use the multi-meter to measure the PV array voltage to verify if PV array is working normally, if not, please fix the PV array to normally working states before connection
- Inspect the PV+ and PV- output of the PV string, make sure the positive and negative poles of PV and inverter will be correctly connected.

### Cable Requirement:

Cross-section	Cable Diameter	Minimum Voltage
3 - 6 mm <sup>2</sup>	12AWG - 10AWG	600V

**Step 1:** Turn off or disconnect the PV switch (DC switch). Then keep this switch always open during the connection.

**Step 2:** Assemble the PV connector

a) Strip 6~8mm insulation from the cable end.

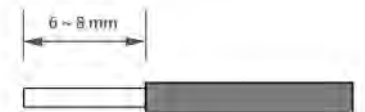

b) Assemble the cable ends to crimp contacts.



c) Lead the cable through the cable gland, then insert into the corresponding insulator until it snaps into place, then tighten the cable gland.

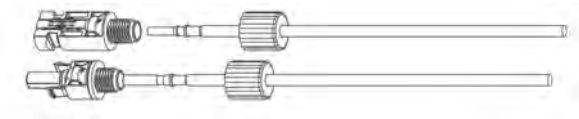

**Step 3:** Install the PV connector.

When verified the PV connector is tightly, align the 2 half connector and mate them together by hands until 'click' is felt or heard.

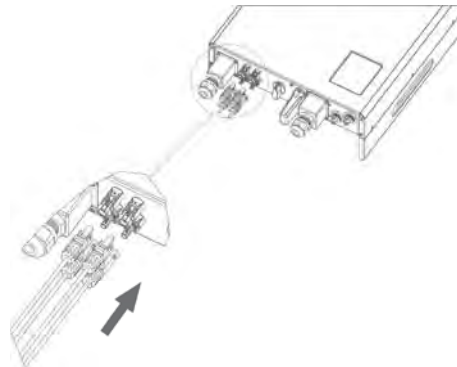

## 5.3 Battery Connection

This part in this manual only describe the battery connection on inverter side, should you need more detailed information regarding the battery connection on battery side please refer to the manual of the battery you are using.

### Battery Power Connection

**Cable Requirements:**

Cross-section	Type	Diameter
11 - 16 mm <sup>2</sup>	OT (M5)	3.8 mm - 4.6mm

**Step 1:** Assemble the terminal.

a) Strip 10mm insulation from the cable end.

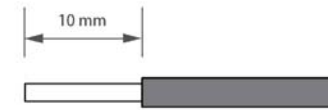

b) Uninstall the waterproof cover (BAT) and lead the battery cables through the corresponding cable gland, seal ring, and threaded sleeve. Then crimp the OT terminal, install the heat shrinkable casing.



**Step 2:** Install the battery power connector

a) Fasten the connection terminal to corresponding BAT terminal blocks (BAT+ and BAT-).

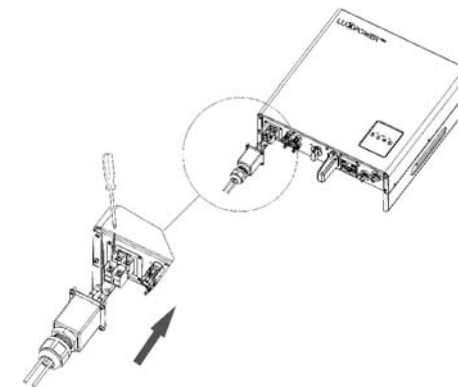

b) Firmly install the waterproof cover (BAT) back to the inverter.

### Battery Communication Connection

If the battery type is lithium-ion or ternary battery which need communication between the inverter and battery management system (BMS), the communication connection must be installed. Please refer to **Chapter 5.7 Communication and Wi-Fi Connection** for the connection guidance.

## 5.4 Grid Connection

### Cable Requirements:

Cross-section	Diameter
3 - 6 mm <sup>2</sup>	2 mm - 2.6 mm

**Step 1:** Assemble the AC connector.

### AC Connector Structure Overview

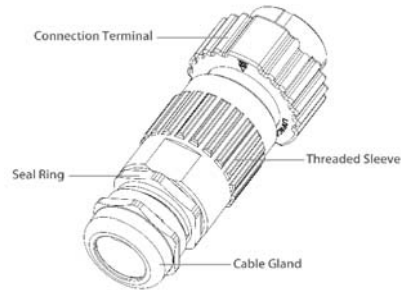

- a) Lead the AC cable through cable gland, seal ring and threaded sleeve, and fully insert the conductors to corresponding terminals on connection terminal and tighten the screws.

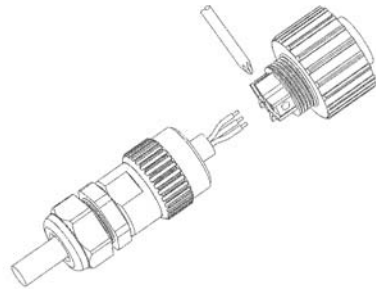

- b) Refer to below figure and confirm the AC cables are correctly connected.

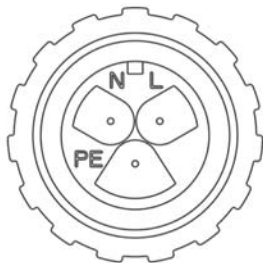

- c) Assemble the AC connector and make sure that the rib of the terminal block and the groove on the housing engage perfectly until a 'click' is heard or felt.

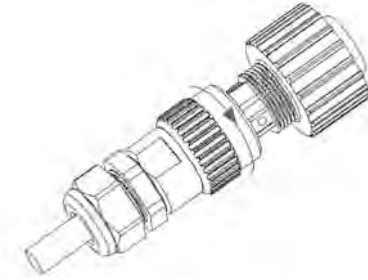

**Step 2:** Install the AC connector

- a) Align the AC connector and the AC terminal and mate them together by hand until a 'click' is heard or felt.

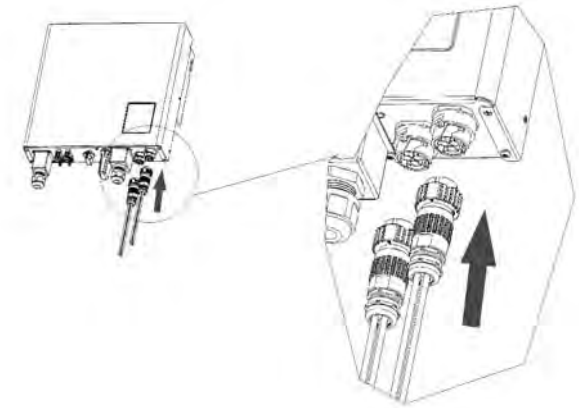

- b) An AC breaker (AC switch) should be installed between inverter and the grid, confirm the AC breaker is working normally before connect the AC cable from inverter to AC breaker. Turn off the AC breaker and keep it open.
- c) Connect the PE conductor to grounding electrode, and connect the N and L conductors to AC breakers.
- d) Connect the AC breakers to the AC grid.

## 5.5 EPS/Back-up Connection

**Step 1:** Assemble and install the EPS connector process is the same as AC connectors which show in Chapter 5.4 Grid Connection (the Step 1 and Step 2). Finish the EPS connector assembling and installation first of all.

**Step 2:** EPS wiring.

There are 2 different EPS wiring mode in accordance with different local or national rules, standards or regulations. Please choose the suitable wiring mode according to the local requirements.

**Mode A:** Neutral line of alternative supply must not be isolated or switched.

The connection diagram of EPS Connection Mode A is shown in below figure.

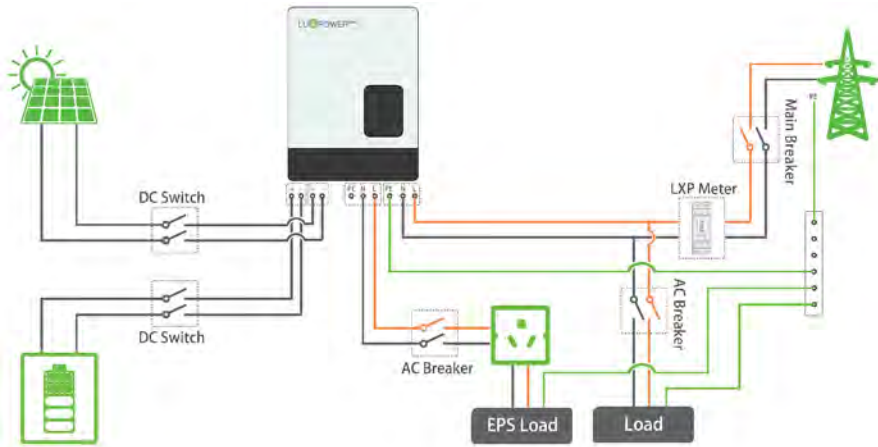

**Mode B:** Neutral line of alternative supply can be isolated or switched.

The connection diagram of EPS Connection Mode B is shown in below figure.

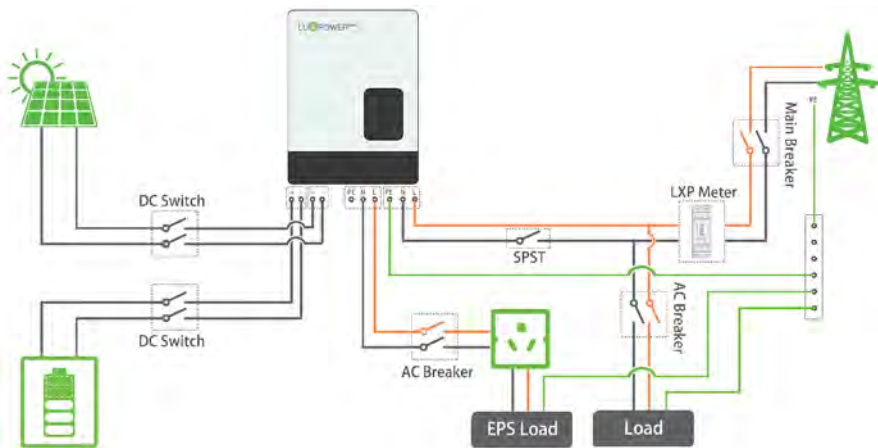

## 5.6 Meter and CT Connection

### CAUTION

The meter and CT could not install together in a single system. User or the system designer should choose either meter or CT in a system.

### NOTICE

The system is controlled via meter or CT, the current flow from grid to load is defined as positive while current from the inverter to grid is defined as negative.

#### a) Connect the Meter

The functional interfaces overview of the meter is shown in below figure.

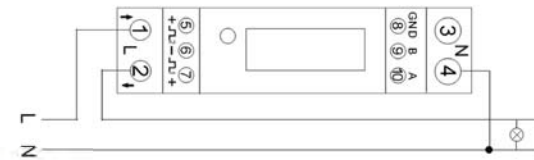

### NOTICE

Above figure shows only the information of EASTRON SDM120 Modbus model meter, while other models or brands meters please refer to its dedicated user manual.

In a completed installed on-grid energy storage system, the connection diagram of power line of the meter is shown in below figure.

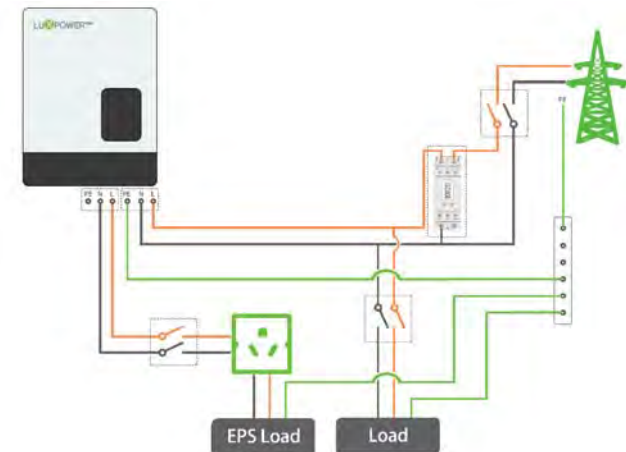

To connect the communication line of the meter to the inverter, please refer to **Chapter 5.7.2 Meter RS485/CT Connection**.

When the meter displays **-xxxW** as below figure shows, the hybrid inverter is feeding power to the grid.



When the meter displays **xxxW** as below figure shows, the load is consuming the power from grid.



When the meter displays as below figure shows, the system is importing active energy.



When the meter displays as below figure shows, the system is exporting active energy.



**b) Connect the CT**

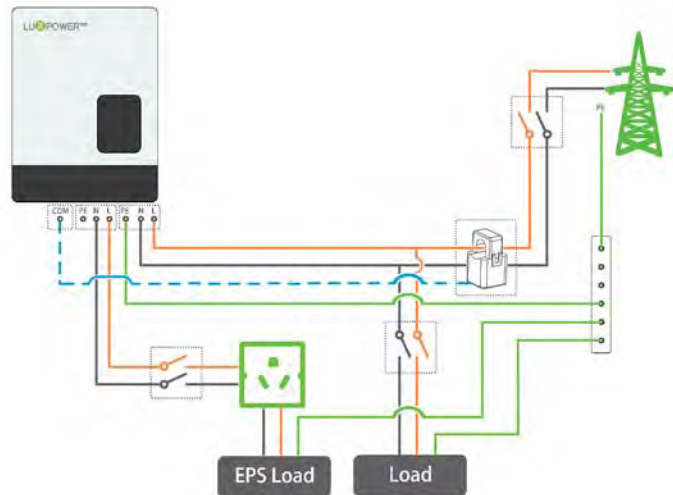

## 5.7 Communication Connection

There are communication interfaces and configuration switches in the communication port (COM) on the bottom of the inverter as shown below:

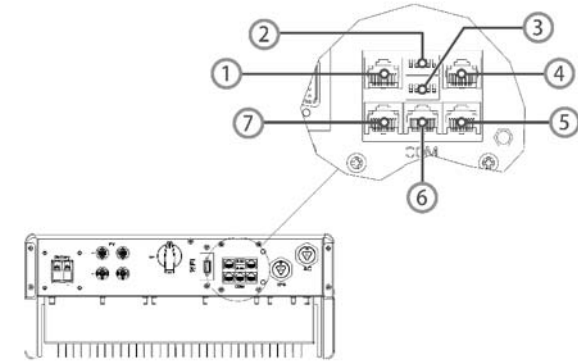

No.	Interface/Switch	Remarks
1	Battery Communication Interface	RS485 and CAN
2	Safety Standard Configuration Switch	Configuration Switch
3	Balancing Resistor Configuration Switch	Configuration Switch
4	CT and Meter Communication Interface	Either CT or Meter
5	Inverter RS485 Interface	Reserved Interface
6	DSP RS485 Interface	Reserved Interface
7	DRM Interface	Demand Response Control

### 5.7.1 Battery RS485/CAN Connection

#### Battery Communication Interface Overview

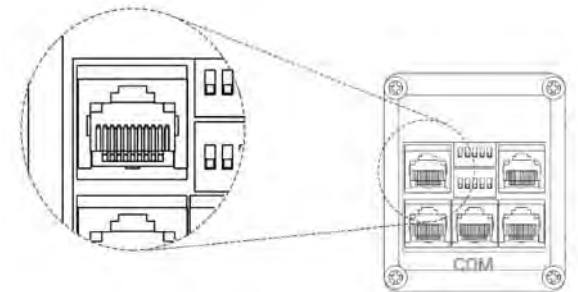



**RJ45 Terminal Configuration of Battery Communication**

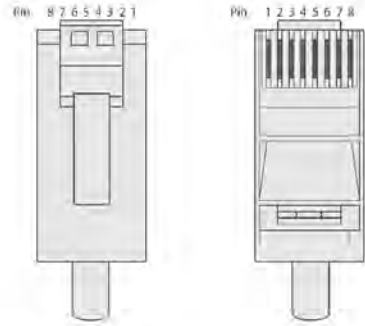

Pin	Function Description
1	BAT 485 B
2	BAT 485 A
3	BAT CAN L
4	BAT CAN H

Pin	Function Description
5	NC
6	BAT NTC
7	BAT Wake UP
8	GND-S

Make the RJ45 terminal based on above introduction of each Pin definition, you could either make RS485 connector or CAN connector based on the best support connection way of your battery packs.

**Cable Connection**

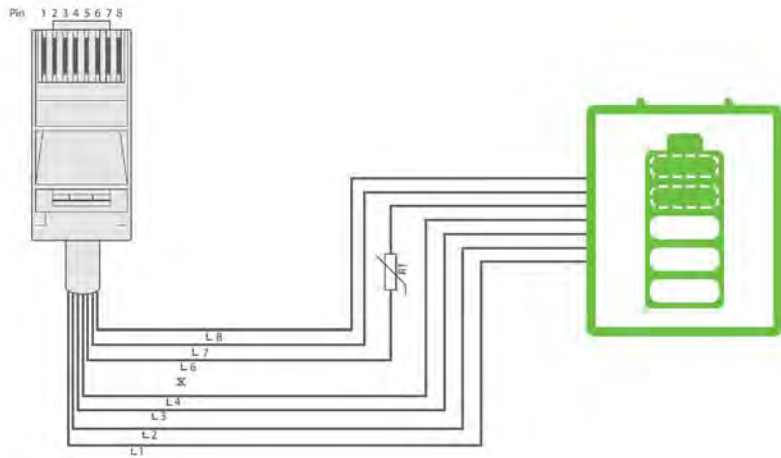

**Connect Battery RS485 or CAN**

- a) Unscrew and remove the water proof cover of communication interfaces and loosen the cable gland on it.
- b) Lead the RS485/CAN cable through the cable gland and plug the RS485/CAN terminal into corresponding

Battery RS485/CAN ports interfaces firmly.

- c) If you finish all the other communication connections, then fasten the cable gland and install the water proof cover of communication interfaces back to inverter firmly. Or you can continue other communication connection works directly after step b).

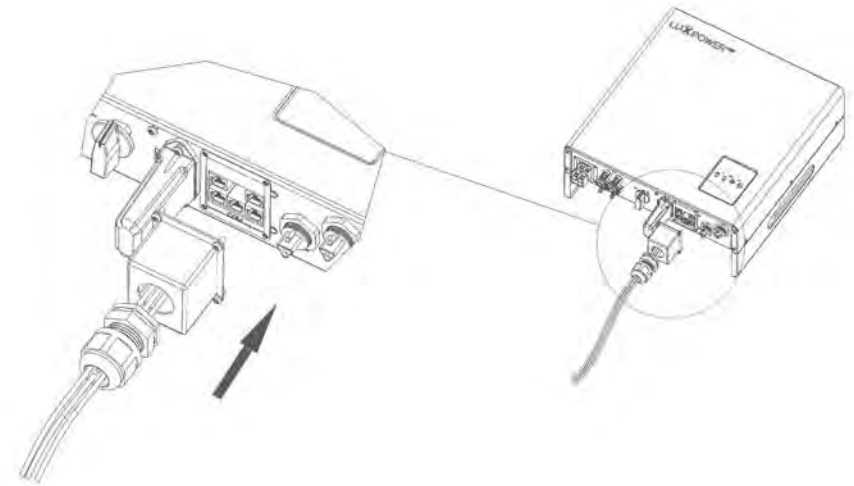

**5.7.2 Meter RS485/CT Connection**

**Meter and CT Communication Interface Overview**

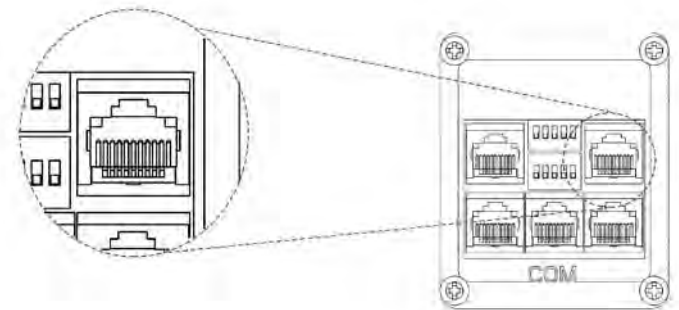

**RJ45 Terminal Configuration of Meter/CT Communication**

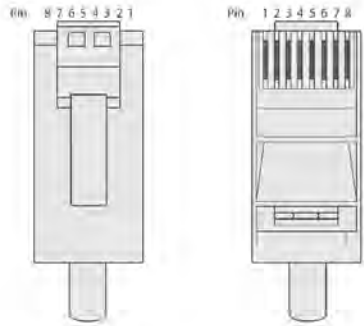

Pin	Function Description
1	BAT 485 B
2	BAT 485 A
3	NC
4	NC

Pin	Function Description
5	CT1 N
6	CT1 P
7	CT2 N
8	CT2 P

**Single Phase Meter RS485 Cable Connection Overview**

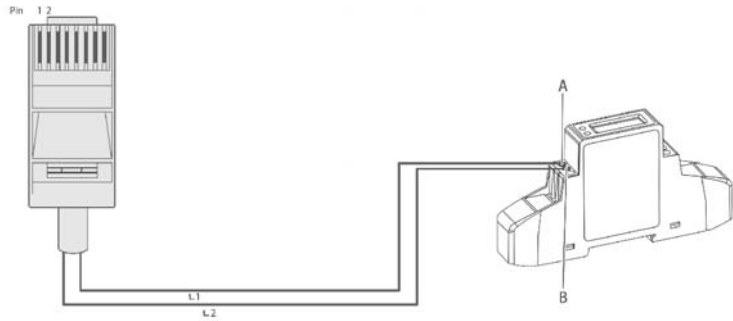

**Split Phase Meter RS485 Cable Connection Overview**

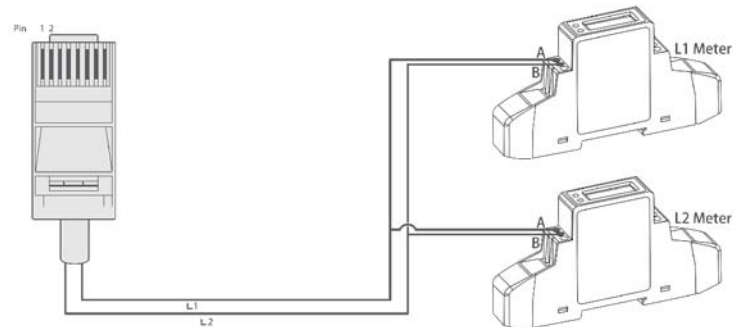

**Single Phase CT Cable Connection Overview**

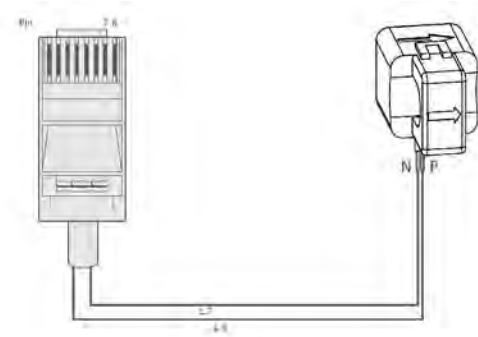

**Split Phase CT Cable Connection Overview**

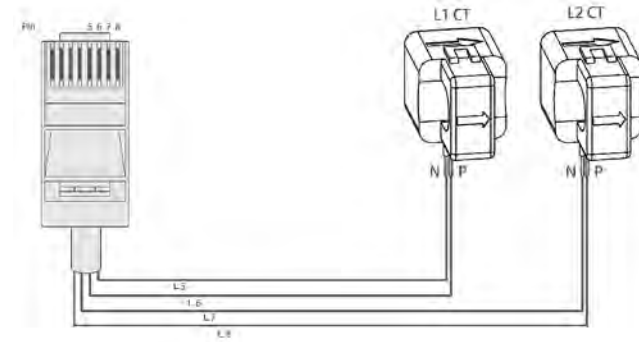

**Connect Meter RS485 or CT**

- Unscrew and remove the water proof cover of communication interfaces and loosen the cable gland on it.
- Lead the Meter RS485 or CT cable through the cable gland and plug the RS485 or CT terminal into corresponding meter/CT ports interfaces firmly.
- If you finish all the other communication connections, then fasten the cable gland and install the water proof cover of communication interfaces back to inverter firmly. Or you can continue other communication connection works directly after step b).

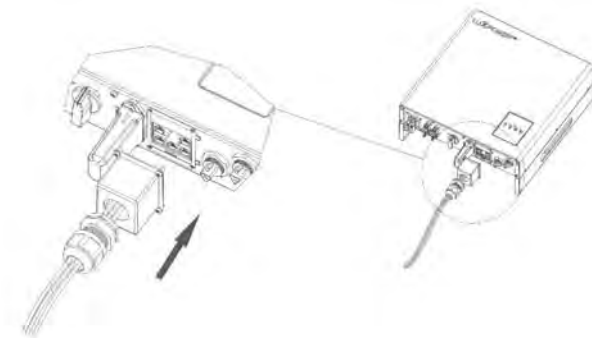

### 5.7.3 DRM Connection

#### DRM Communication Interface Overview

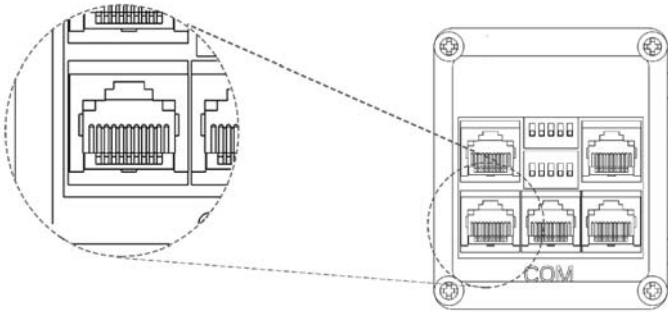

#### RJ45 Terminal Configuration of DRM

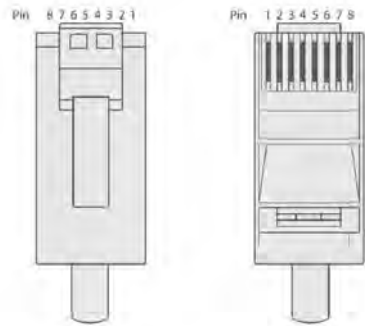

Pin	Function Description
1	DRM15
2	DRM26
3	DRM37
4	DRM48

Pin	Function Description
5	RefGen
6	DRM0
7	+12V
8	GND-S

#### DRM Cable Connection Overview



#### DRM Control Circuit Connection Diagram

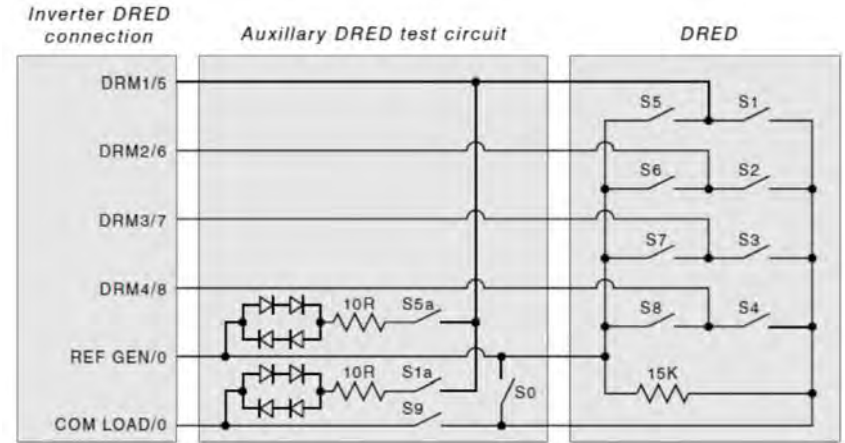

#### Connect DRM

- Unscrew and remove the water proof cover of communication interfaces and loosen the cable gland on it.
- Lead the Meter RS485 or CT cable through the cable gland and plug the RS485 or CT terminal into corresponding meter/CT ports interfaces firmly.
- If you finish all the other communication connections, then fasten the cable gland and install the water proof cover of communication interfaces back to inverter firmly. Or you can continue other communication connection works directly after step b).

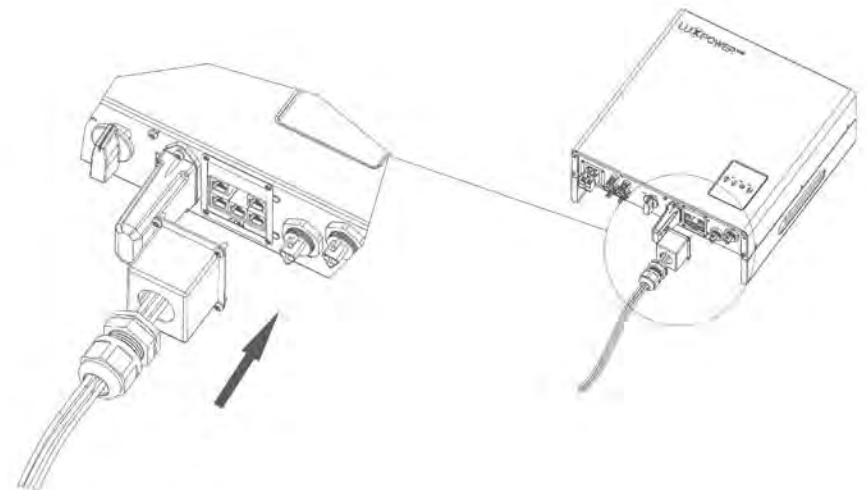

### 5.7.4 Safety Standard Configuration - SW2

By configuring the SW2 safety standard configuration switch the inverter could comply with different requirements of various countries and areas.

#### SW2 Safety Standard Configuration Switch Overview

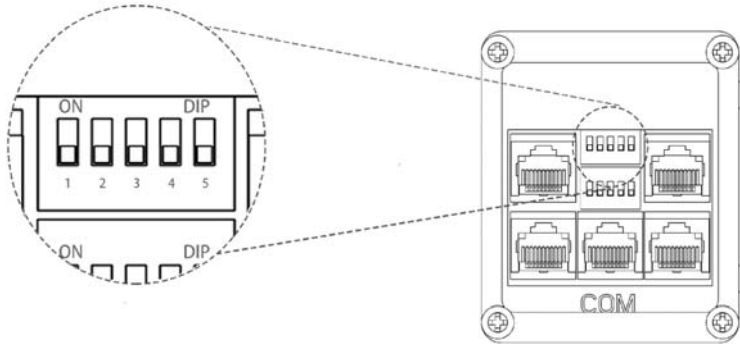

#### Safety Standard Configuration Guidance

Country Standard	SW2 Configuration	Country Standard	SW2 Configuration
Default VDE0126		China CGC	
Germany VDE0126		United Kingdom G59	
Australia AS4777		United Kingdom G83	
New Zealand NZS		Germany N4105	

### 5.7.5 Balancing Resistor Configuration - SW1

By configuring the SW1 balancing resistor configuration switch, you could configure the balancing resistors of RS485 and CAN communication. This Function is reserved for multiple inverter paralleling operation.

#### SW1 Balancing Resistor Configuration Switch Overview

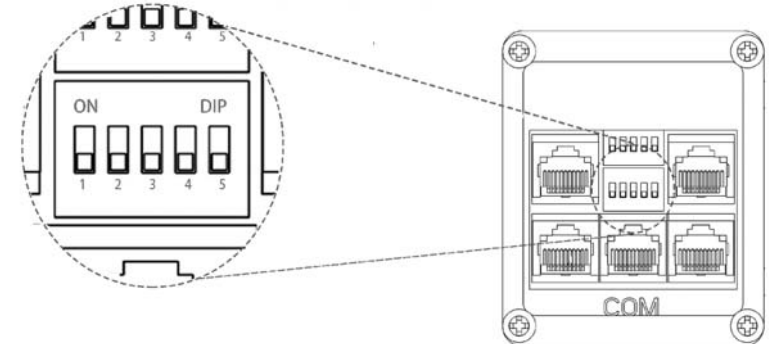

#### Balancing Resistor Configuration Guidance - Reserved Function

Balancing Resistor	SW1 Configuration	Description
RS485 Balancing Resistor		When several units inverter connected via RS485 communication, the balancing resistor switch 3 should be set to ON position.
CAN Balancing Resistor		When several units inverter connected via CAN communication, the balancing resistor switch 4 and switch 5 should be set to ON position.

### 5.7.6 Wireless Communication Module Connection

#### Wireless Communication Interface Overview

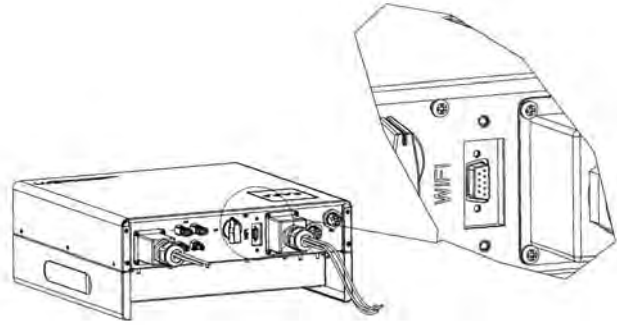

#### The Wireless Communication Interface Details

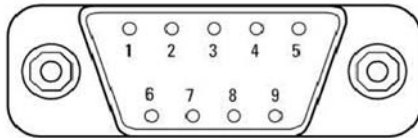

Pin	Function Description	Pin	Function Description
1	NC	5	GND-S
2	RS485 B	6	NC
3	RS485 A	7,8	NC
4	NC	9	VCC

#### Wireless Communication Module Installation and Connection

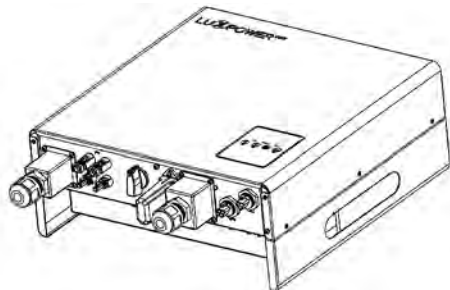

## 5.8 Grounding

A second protective earth (PE) terminal is equipped at the side of the inverter. Be sure to connect this PE terminal to the PE bar for reliable grounding.

#### Cable Requirements

3-6mm<sup>2</sup> copper cable or 10-16mm<sup>2</sup> aluminum cable.

#### CAUTION

If the positive pole or negative pole of the PV array is required to be grounded, then the inverter output (to AC grid) must be isolated by transformer in accordance with IEC62109-1, -2 standard.

#### NOTICE Install the Protective Shell

When you finish all of above chapters steps of connections, please don't forget to install the protective shell back to the inverter. This step can be carried out either after finished grounding or commissioning of the system.

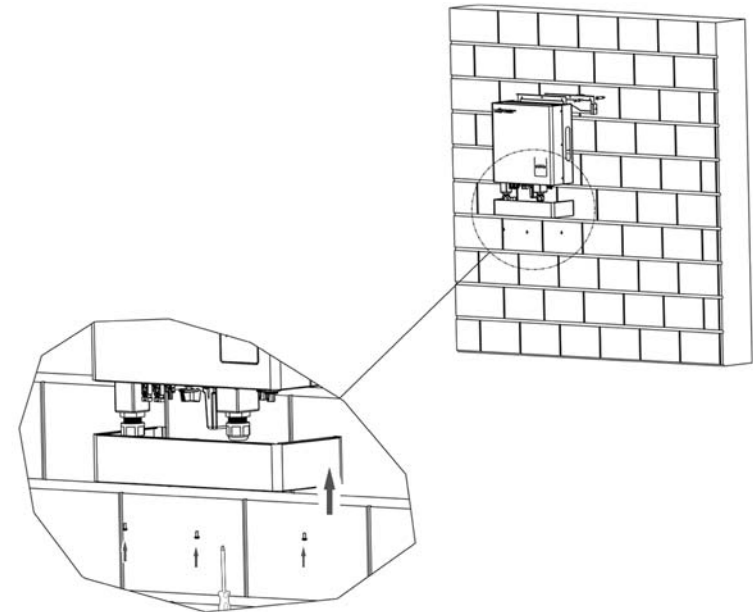

# 6. Operation Guide

## 6.1 LCD Menu Structure Overview

### Menu Structure Overview

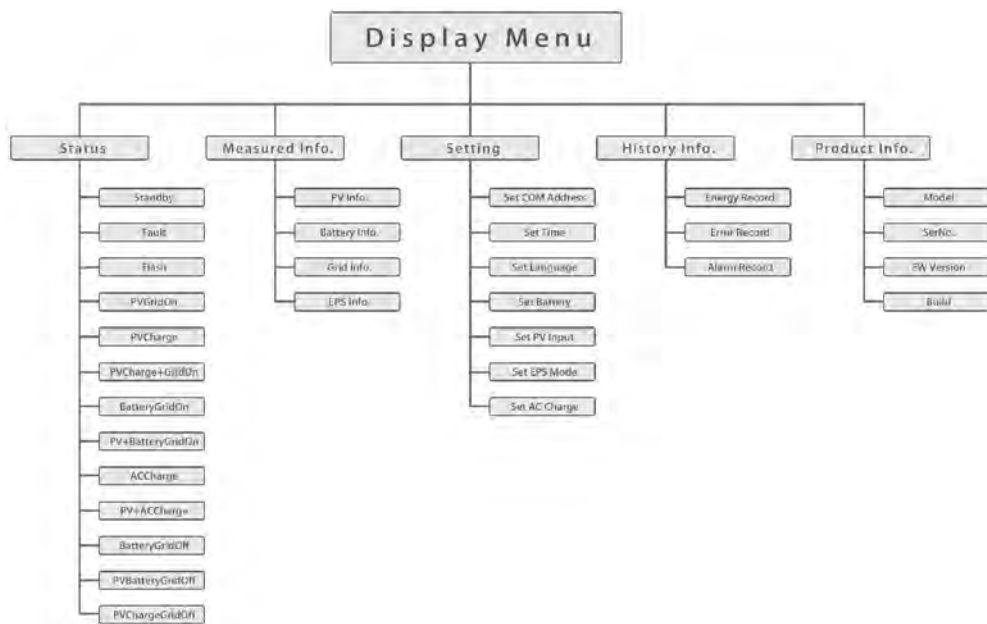

### Noun Explanation of LCD Displays

Nouns	Explanation	Remarks
Status	Inverter working status	
Measured Info.	Data measured by inverter	To review running data of system
Setting	Inverter Setting	To set running data of inverter
History Info.	History data recorded by inverter	To review history data of system
Product Info.	Product information of inverter	To check inverter product details
Standby / Fault / Flash / PVGridOn ... .. / PVChargeGridOff	Different working status of the inverter, Switches based on user settings and the system input and output conditions.	Refer to <b>Chapter 6.3 Inverter Working Status</b> for detailed information.

PV Info. Battery Info. Grid Info. EPS Info.	The measured running information of PV, battery, grid and EPS, including power, energy and SOC etc. data.	Refer to <b>Chapter 6.2.1 Information Searching - d) Search Measured Information</b> for guidance and details.
Set COM Address / Set Time / Set Language / Set Battery / Set PV Input / Set EPS Mode / Set AC Charge	The setting options of the inverter settings, including different system and inverter settings	Refer to <b>Chapter 6.2.2 Settings Guidance</b> for guidance and details.
Energy Record Error Record Alarm Record	History information options including energy generation and consumption, error and alarm records.	Refer to <b>Chapter 6.2.1 Information Searching - b) Search History Information</b> for guidance and details.
Model SerNo. FW Version Build	Product information including inverter working model, serial number, firmware version and build information.	Refer to <b>Chapter 6.2.1 Information Searching - c) Search Product Information</b> for guidance and details.

### Parameter Explanation of LCD Displays

Parameters of Power:

Ppv: PV input power      Pac: active power of AC output      Sac: apparent power of AC output  
 Po: active power of EPS      So: Apparent power of EPS      Pc: Charging power      Pd: discharging power  
 PtoGrid: active power of exporting / feed-in to grid

Parameters of Voltage and Frequency etc.:

Vb: battery voltage      Vo: EPS voltage      Vbus: voltage of DC bus      Vg: grid voltage  
 F: frequency      SOC: state of charge

Parameters of Energy:

Einvdag: energy output via AC output today      Einvall: total energy output via AC output  
 Ecdag: charged energy today      Ecall: total charged energy      Eddag: discharged energy today  
 Edall: total discharged energy      Eodag: EPS output energy today      Eoall: total EPS output energy  
 Epv1dag: energy generated today of PV array 1      Epv2dag: energy generated today of PV array 2  
 Epv1all: total energy generated of PV array 1      Epv2all: total energy generated of PV array 2  
 Erecdag: AC charge energy of today      Erecall: total AC charge energy      EtoUdag: energy consumed by loads today  
 EtoUall: total energy consumed by loads      EtoGdag: feed-in energy today      EtoGall: total feed-in energy

## 6.2 LCD Operation and Setting Guidance

### 6.2.1 Information Searching

Refer to below flow chart which shows the information option interfaces and interconnection. Operator can search target information by following below directions.

#### a) Enter into Display Menu Interface

Touch **Return** button to enter **Display Menu** interface, search and select corresponding information options using **Up** and **Down** button, relevant information will be immediately displayed on the LCD screen after touched **Enter** button to confirm the selection.

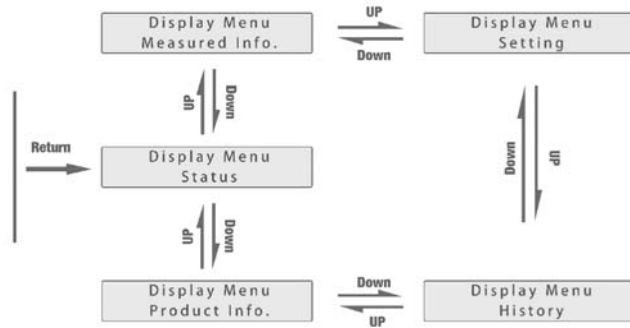

#### b) Search History Information

In **Display Menu** interface, select **History** menu and touch **Enter** button to enter in the **History** menu interface and use **Up** and **Down** button to select relevant display menu and touch **Enter** button to view detailed history information.

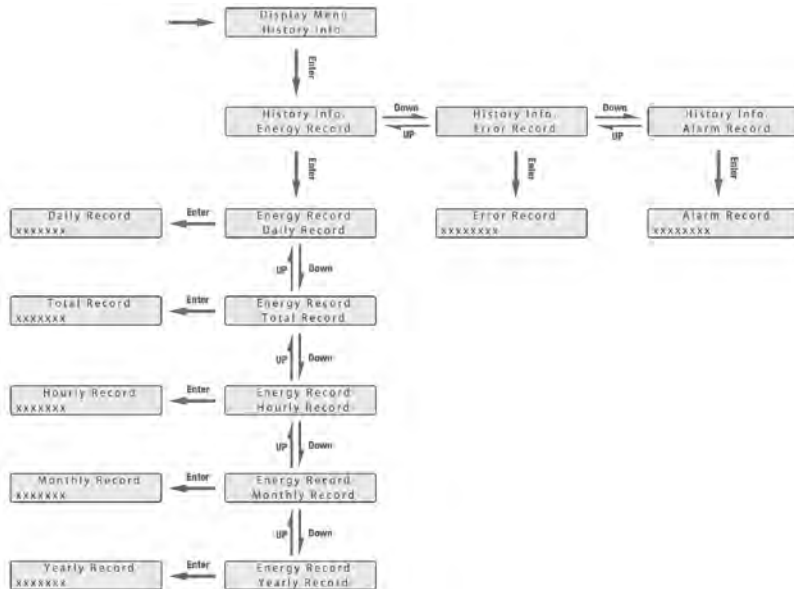

#### c) Search Product Information

In **Display Menu** interface, select **Product Info.** menu and touch **Enter** button to enter in the **Product Info.** menu interface to view detailed product information.

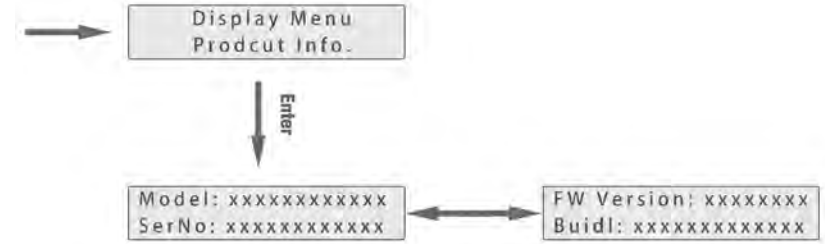

#### d) Search Measured information

In **Display Menu** interface, select **Measured Info.** menu and touch **Enter** button to enter in the **Measured Info.** menu interface to view detailed running information of the system, such as PV, battery, grid and EPS data.

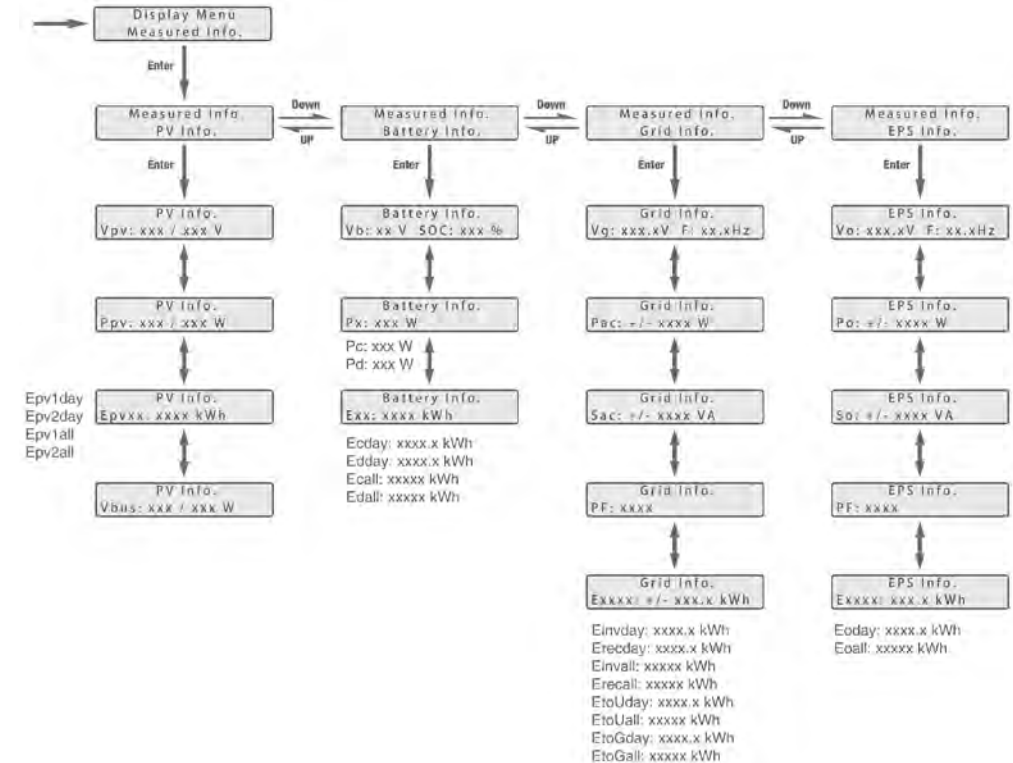

## 6.2.2 Settings Guidance

### a) Enter Into Setting Interface

Touch **Return** button to enter into **Display Menu** interface, search and select the **Setting** menu using **UP** and **Down** button, and then touch **Enter** button to confirm and enter into inverter setting interface.

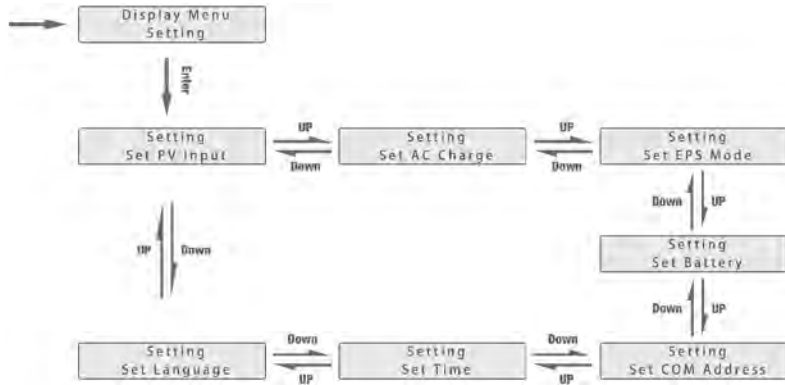

### b) Language Setting

In **Setting** interface, search and select **Set Language** menu using **UP** and **Down** button, then touch **Enter** button to confirm and enter into **Set Language** interface. The inverter display language is set to be English by default after manufactured.



### c) Communication Address Settings

In **Setting** interface, search and select **Set Com Address** menu using **UP** and **Down** button, then touch **Enter** button to confirm and enter into the inverter RS485 communication address setting interface. Follow the direction in below flow chart to set the communication address.

Notice that the setting range of the RS485 communication address is from 000 to 255, and it's set to be 001 by default when manufactured.

**Operating Guidance:** by touching **Enter** button to select the numerical digits of the COM address - hundreds, tens and units, and use **UP** and **Down** button to set the number of selected numerical digits.

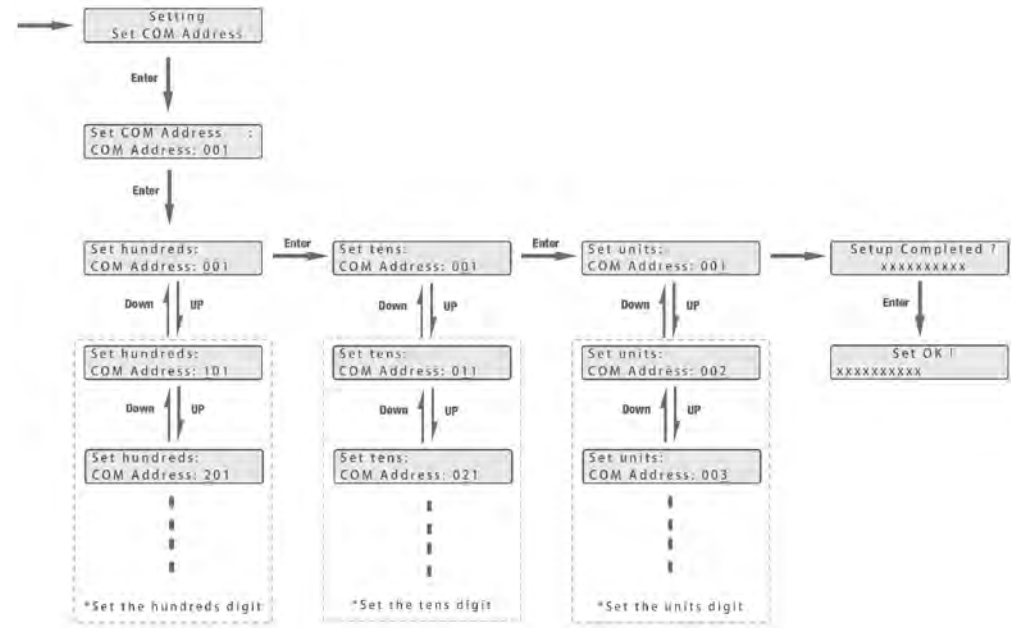

### d) Battery Settings

In **Setting** interface, search and select the **Set Battery** menu and touch **Enter** button to confirm and enter into battery setting interface. Set the battery parameters and configuration follow the direction in below flow chart. Notice that the LXP Hybrid series energy storage inverter supports Lithium-ion and Lead-Acid type batteries.

**Operating Guidance:** by touching **Enter** button to select the options and use **UP** and **Down** button to set the parameter or number of selected options.

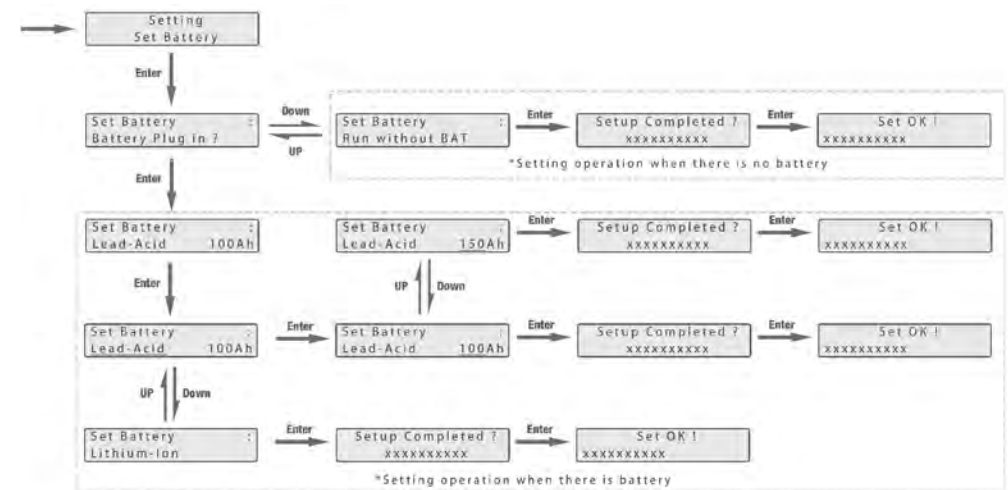



e) Time Settings

In **Setting** interface, search and select **Set Time** menu then enter into time setting interface. Follow the direction in below flow chart to set the time parameters.

**Operating Guidance:** by touching **Enter** button to select the numerical digits of the time - year, month, date, hour and minute, and use **UP** and **Down** button to set the number of selected numerical digits.

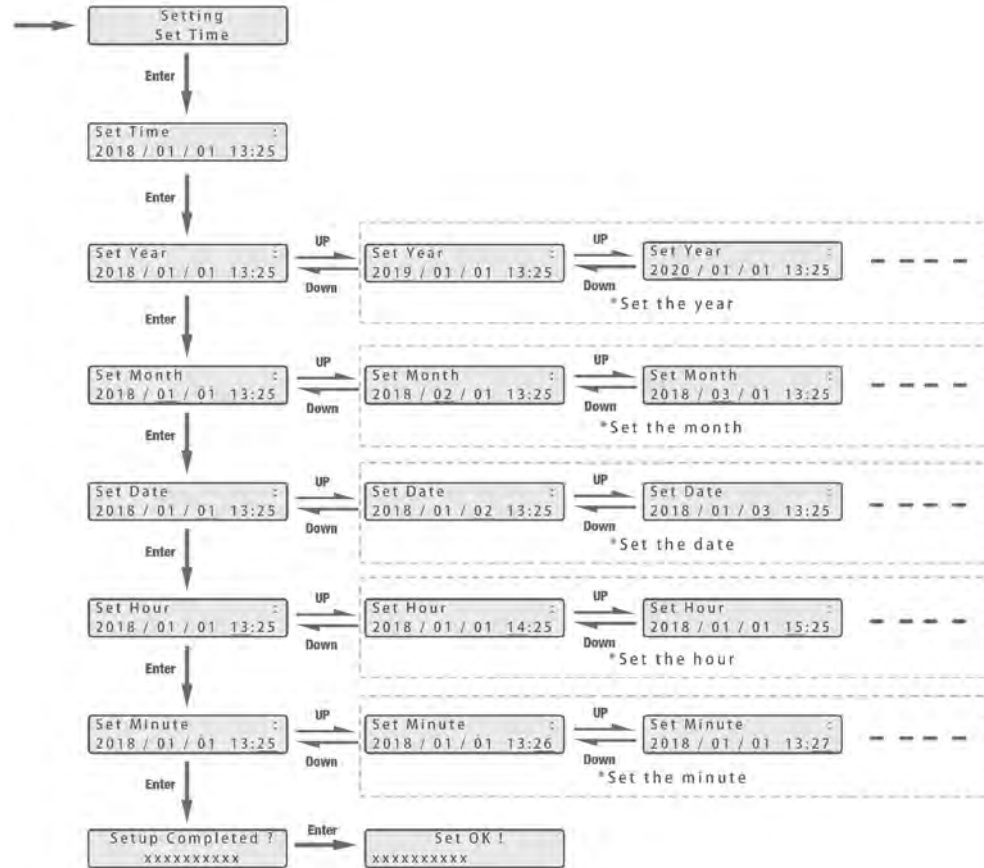

f) PV Input Settings

In **Setting** interface, search and select the **Set PV Input** menu, then enter into **PV input setting** interface. Set the PV input parameters follow the directions in below flow chart.

**Operating Guidance:** by touching **UP** and **Down** button to select the parameter of the PV input. Notice that the PV input parameters must be set in accordance to actually configuration of PV system. The parameter is set to **Two PV separate** by default.

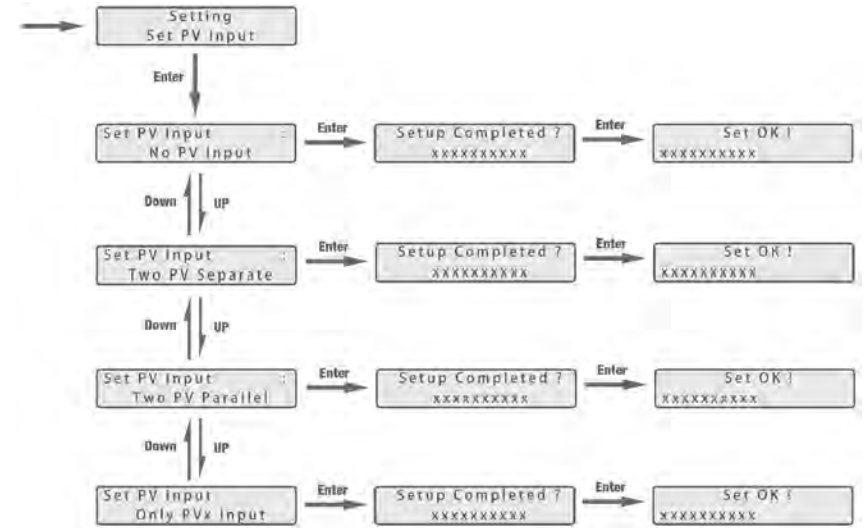

g) EPS Settings

In **Setting** interface, search and select **Set EPS Mode** menu, then enter into EPS setting interface. Follow the directions in below flow chart to enable or disable EPS mode and setting EPS parameters if enabled EPS mode.

Please configure the EPS output parameters strictly in accordance with actual situation.

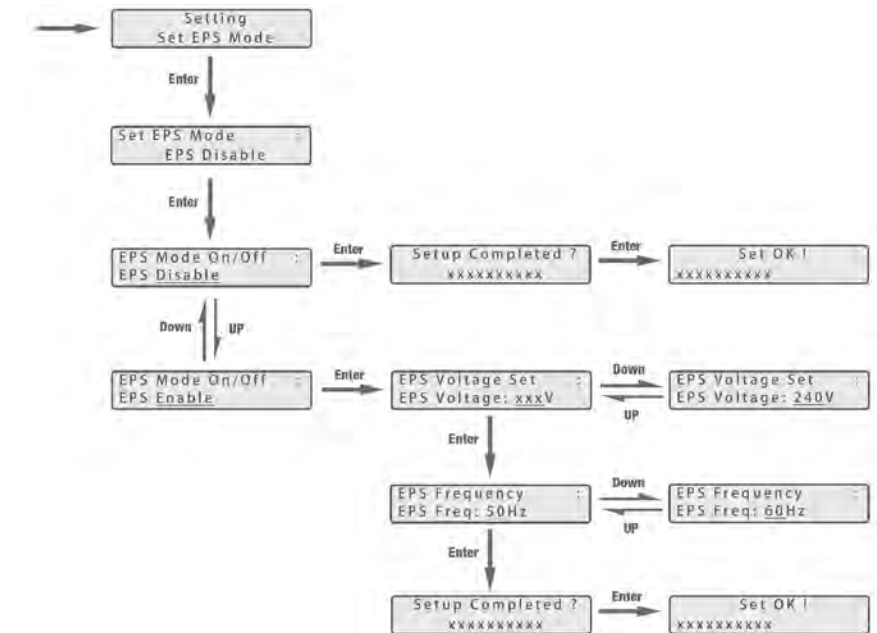

h) AC Charge Settings

**NOTICE**

Please review relevant laws, policies, regulations and standards of your area, and based on your condition to enable or disable the AC Charge function. It's might be forbidden to charge the battery using AC power from the grid in some countries or areas, only when this function is permitted in your national laws you could enable this function.

In **Setting** interface, search and select the **Set AC Charge** menu and enter into AC charge setting interface. Follow the directions in below flow charge to enable or disable AC charge function, if enabled then configure relevant parameters.

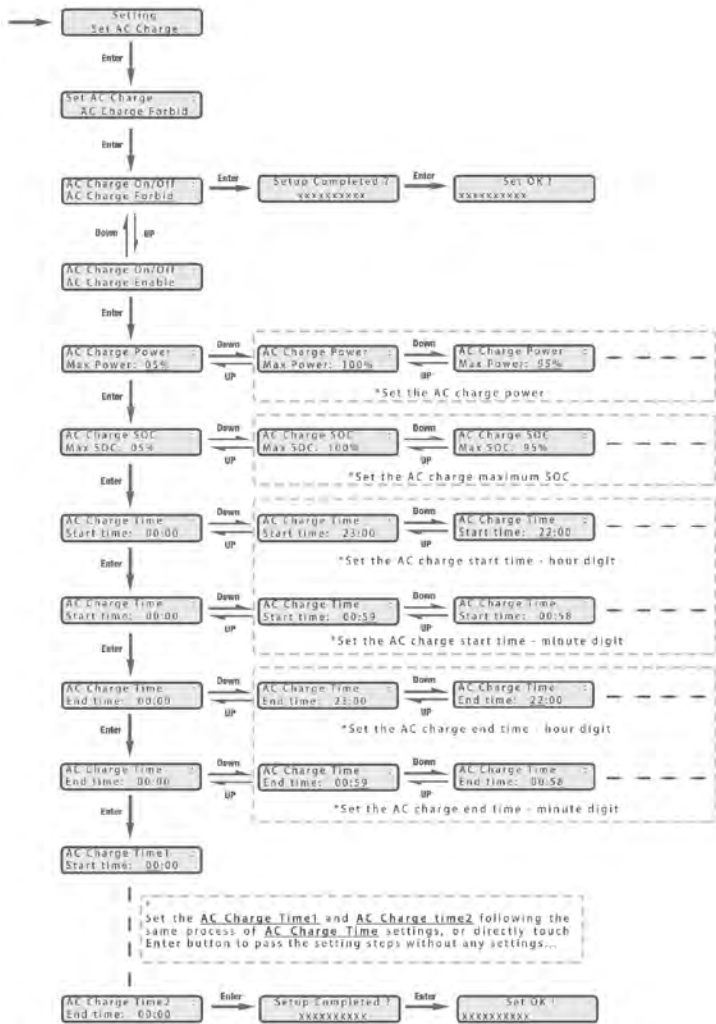

### 6.3 Inverter Working Status

The inverter could work in several working status, and the LCD will display corresponding information.

a) Starting

The inverter is initiating start-up and synchronized with grid, the LCD will displayed as below flow chart shows.

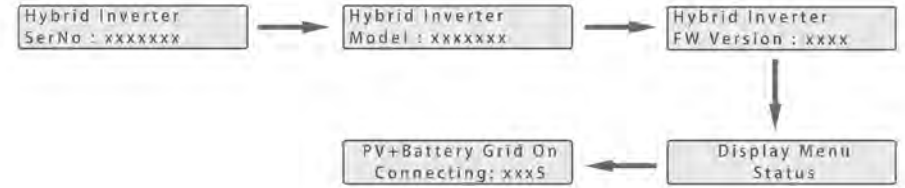

b) Standby

Inverter is waiting for sufficient DC voltage from the PV or battery. It occurs when the sunlight is not sufficient to make the inverter working and battery SOC is low.



c) Fault

Fault occurred with the inverter or system. Inverter will stop working unless fault or error is fixed. Detailed information and troubleshooting please refer to **Chapter 8. Troubleshooting & Maintenance**.



d) Flash

When upgrading the firmware of inverter, the inverter will working at flash status.

There are 2 ways to upgrade the firmware of inverter:

- Remote upgrading based on remotely connected server through the wireless communication module.
- Locally upgrading through RS485 communication connection.



**e) PVGridOn**

The inverter is working normally on-grid, and the all the power generated by PV will export or feed-in via the AC grid connection to your general loads and the grid.

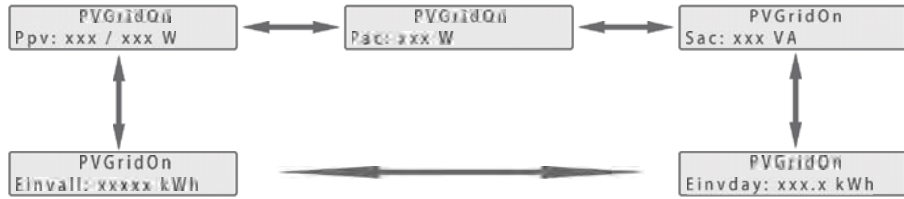

**f) PVCharge**

The inverter is working normally, the power generated by PV is within a range that all the PV power is used to charge the battery, while there are no excessive power rested to output from neither the AC Grid connection nor EPS connection.

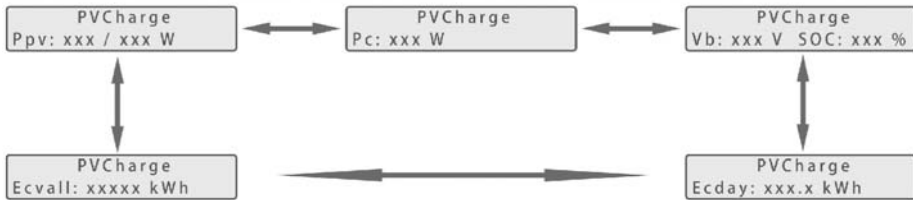

**g) PVCharge+GridOn**

The inverter is working normally on-grid, the power generated by PV is sufficient and within a range which PV power is used to charge the battery and there are still excessive PV power rested to export or feed-in via the AC grid connection. Under this inverter working status, your general loads will either consumption the power from PV or use power from the grid or at them same time from the two sources, the detailed situation is based on the PV power output range and your general loads power demands differences.

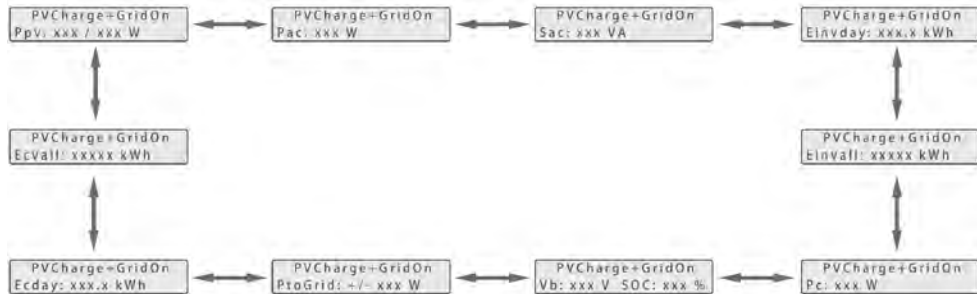

**h) BatteryGridOn**

The inverter is working on-grid with no PV power input, and there are sufficient energy stored in the battery, the inverter is discharging the battery and export the power via AC grid connection to your system.

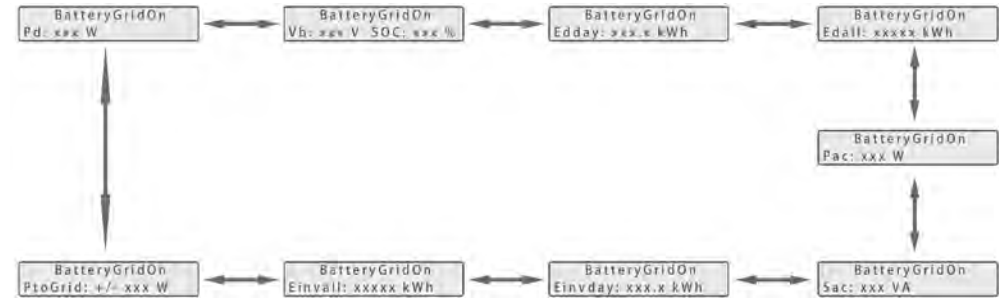

**i) PV+BatteryGridOn**

The inverter is working normally on-grid with limited PV power input and the battery energy is sufficient, at this inverter working status the limited PV power is used together with the battery discharging power to export or feed-in via the AC grid connection.

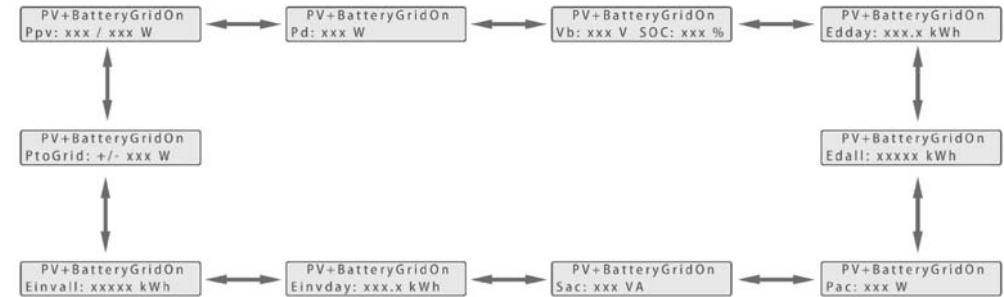

**j) ACCharge**

The inverter is working normally on-grid with no PV input power, and is using the AC power from the grid to charge the battery as configured previously (the function should be enabled firstly as **Chapter 6.2.2 Inverter Settings - h) AC Charge Settings** described).

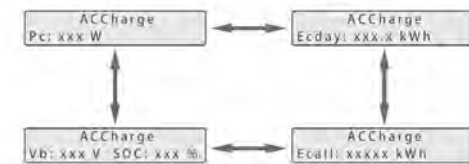

**k) PV+ACCharge**

The inverter is working normally on-grid with limited PV input power, and the batter SOC is not sufficient, if at this time the inverter is configured to charge the battery with both PV power and AC grid power, then inverter will run in this status.

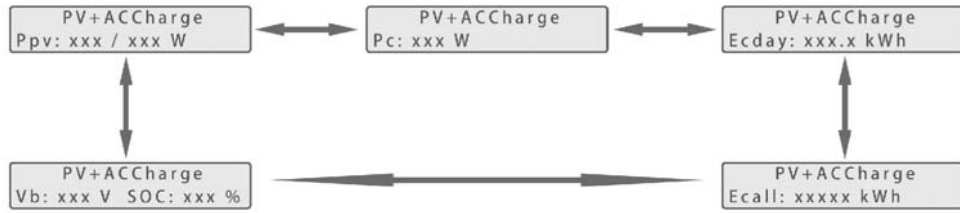

**l) BatteryGridOff**

The inverter is working normally off-grid with no PV input power, and the battery SOC is sufficient. When inverter works at this status, the battery is discharging to output power via the EPS connection.

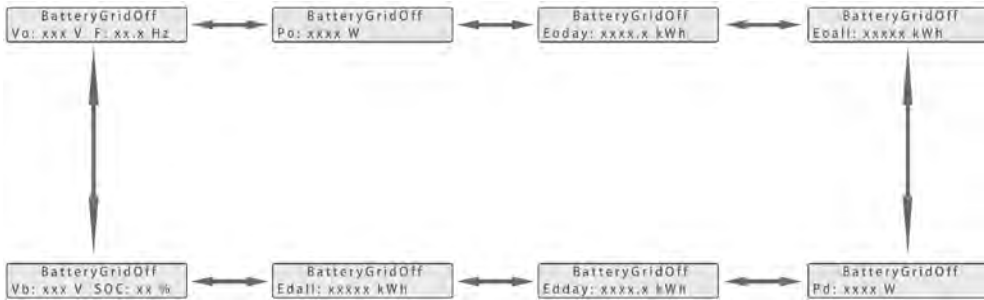

**m) PVBatteryGridOff**

The inverter is working normally off-grid with limited PV input power, and the battery SOC is sufficient. When inverter works at this status, the battery is discharging together with the PV power to output via the EPS connection.

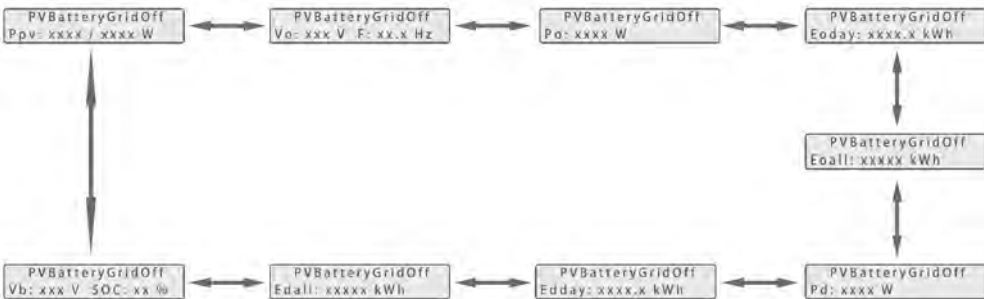

**n) PVChargeGridOff**

The inverter is working normally off-grid with sufficient PV input power, and the battery SOC is insufficient. When inverter works at this status, the inverter is charging the battery using PV power and there are excessive power rested to output via the EPS connection.

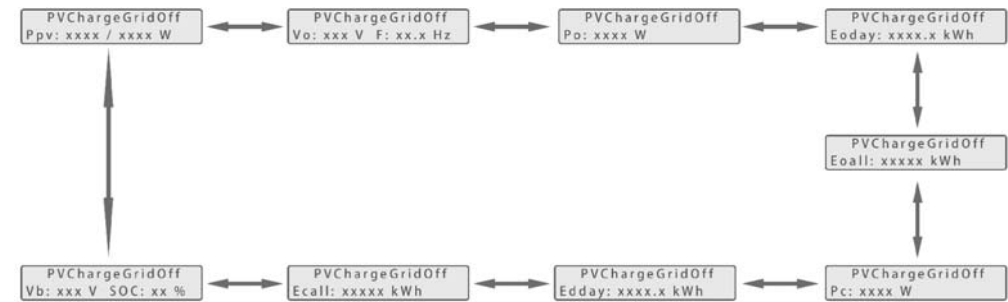

## 6.4 System Working Modes

The inverter support the system to work in different modes:

### 6.4.1 Self Use

Under Self Use mode the priority of the PV energy will be self consumption > battery > grid, which means the energy generated by PV will be mainly used by local loads, and rest will be stored in the battery (finally consumed by local loads), excessive power will be feed back into the grid. This is the default mode which will increase the self consumption rate and reduce the energy bill significantly. Notice that at this mode, the AC charge function is disabled.

There are several different situations of Self Use system working mode based on different input and output of system.

#### a) Self Use Mode - PV power is sufficient

When PV power is sufficient to cover the demands of home loads, then PV power will firstly consumed by home loads, if there is excessive PV power then the excessive power will be used to charge the battery, if there is still PV power rested after load consuming and battery charging, then the rested PV power will be feed-in to the grid (under this situation, the EPS will be always standby if enabled).

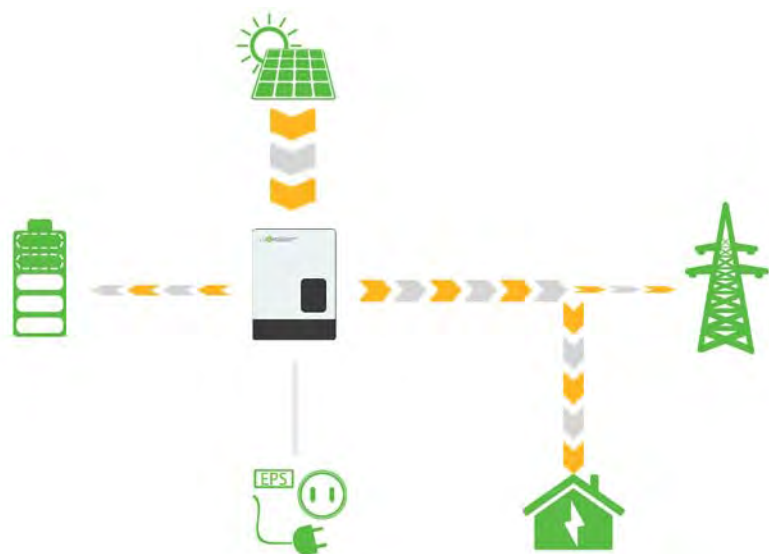

#### b) Self Use Mode - PV power is limited

When PV power is limited and cannot cover all the load consuming demands, all the PV power will be used directly for home load consuming, and the inverter will discharge the battery energy to meet the rest power demand of the loads, if the battery discharging power together with PV power still not enough, then grid power will be consumed by home loads to meet the rested electricity power demands of home loads (under this situation, the EPS will be always standby if enabled).

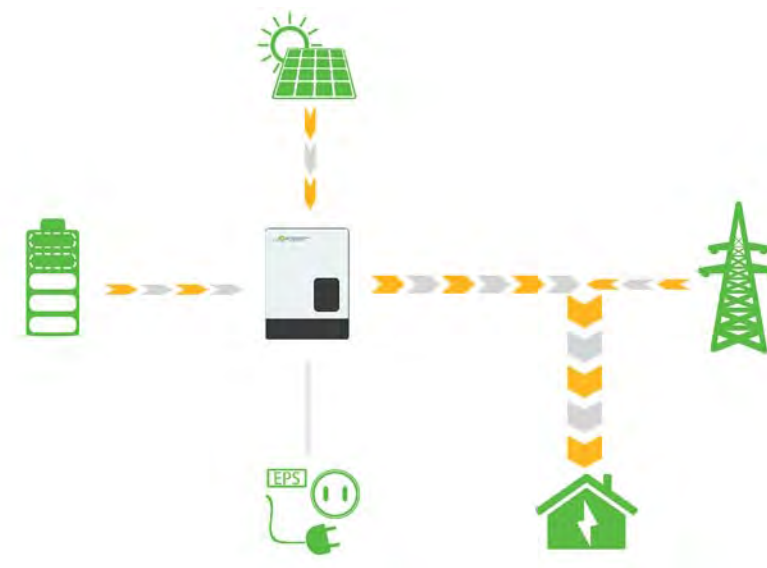

#### c) Self Use Mode - No PV Input

When there is no PV power input (e.g. in the evening or some cloudy or rainy days), the inverter will firstly discharge the battery energy for home load consuming, if not fulfilled the demand then will consume the grid power (under this situation, the EPS will be always standby if enabled).

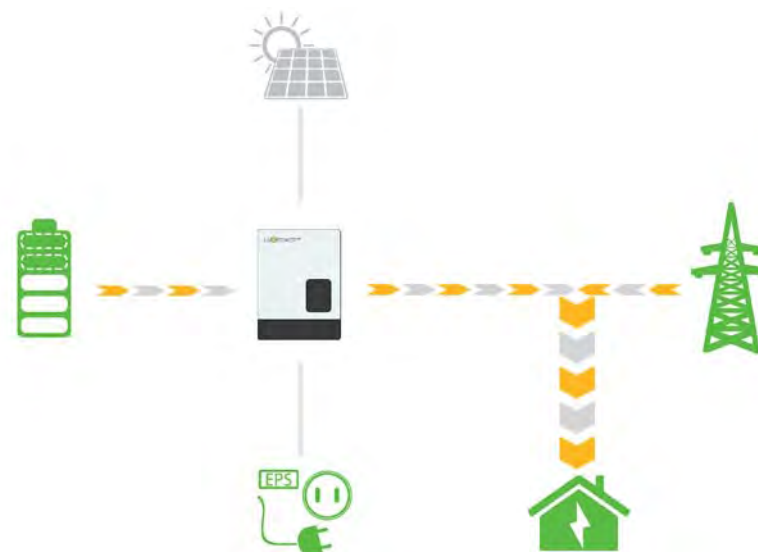

### 6.4.2 Force Time Use

User can set the charging and discharging time and priority of energy use under Force Time Use mode, also enable the user to choose whether to charge the battery using grid power if the regulations permitted. This mode suits for situation where the price difference of energy is big under Time of Use (ToU) . This is also used to flexibly make use of your system by customized settings by the users.

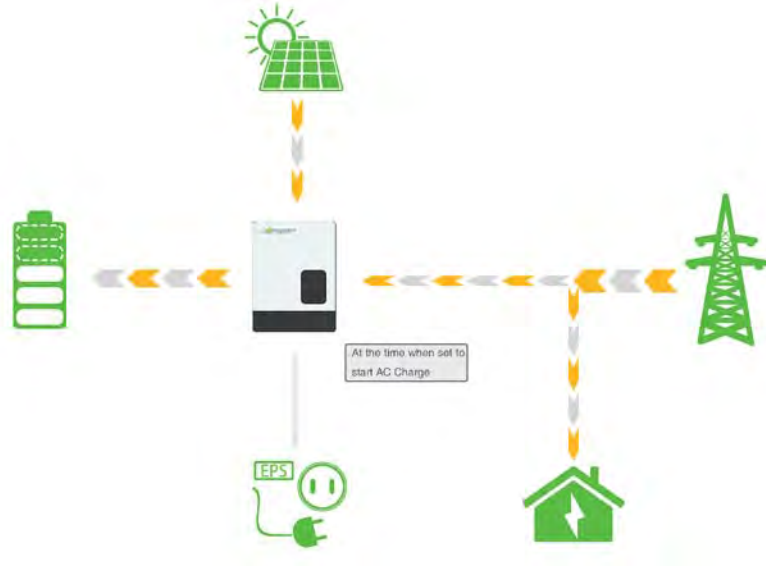

### 6.4.3 Export Control

If there is regulations to limit the export power of a on-grid PV system, you could choose this mode to limit the export rate of your system's output to the grid.

**NOTICE**

To enable this system working mode, the setting interface is not opened through the inverter LCD display area, please ask the manufacturer or your installer/distributor for further assistance.

### 6.4.4 EPS/Back-up/Off-grid

If enabled EPS function, once the grid is protected accidentally, the EPS mode will be automatically and seamlessly activated to ensure your important loads to keep working without any black out. Due to the specially designed function, it can support the system to work as a back-up power system or off-grid system.

#### a) EPS Mode - When PV power is limited

Under the EPS mode when PV power is low or not sufficient enough, system will use all battery power and PV power to power on the EPS loads.

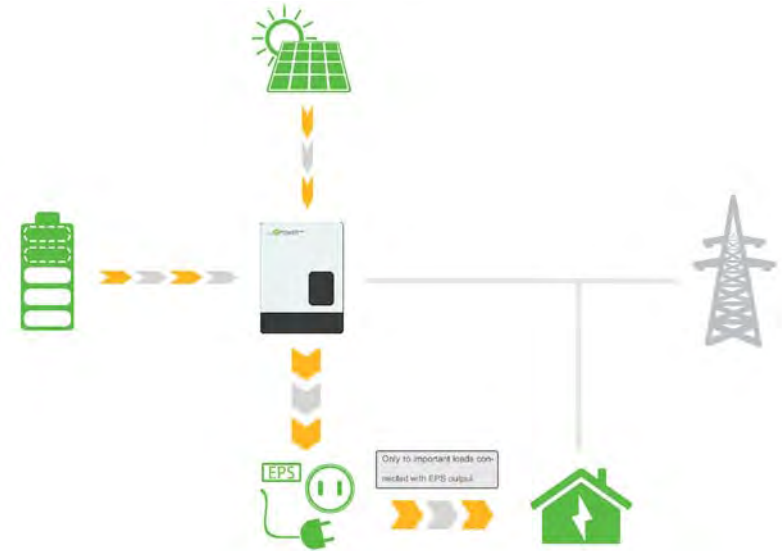

#### b) EPS Mode - When PV power is sufficient

Under EPS mode, when PV power is sufficient, the PV power will be firstly consumed by EPS load and then charge battery.

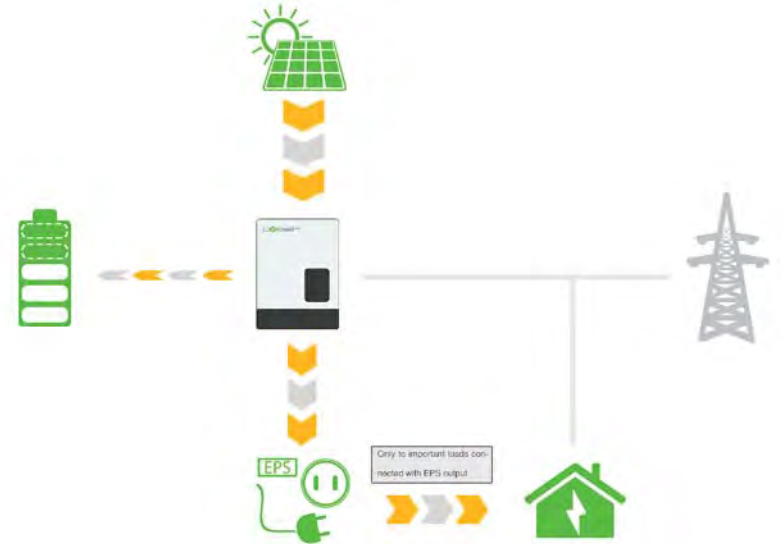

**NOTICE**

Under this mode, EPS mode must be enabled and complete the output voltage and frequency settings.

If EPS output loads are inductive or capacitive loads, to ensure the stability and reliability of system, it's recommended configure the power of these loads to be within 50% EPS output power range.

## 6.5 Start-up/Shut-down/Restart the Inverter

### 6.5.1 Start-up the Inverter

Verify and confirm the installation and wall of inverter is firmly and strong enough, system well grounded, connections of PV, battery and AC etc. Is correctly connected. Then confirm the parameters and configuration is complied with relevant requirements, e.g. PV voltage, battery voltage, grid voltage and frequency etc.

AC Frequency	50/60Hz
PV Voltage	120~550V
Battery Voltage	42~60V
Grid AC Voltage	230V
AC Frequency	50/60Hz

If all above aspects is verified and confirmed to be right and correct, then start-up the inverter follow below procedure.

- Turn the AC switch on, wait till the LCD is lighting and then confirm the AC voltage data displayed normally.
- Turn the DC switches on, and then confirm the PV voltage data displayed normally.
- Observe the Battery voltage displayed on LCD, turn off the battery switched when voltage reaches 48V.
- Wait till the inverter self-checking finished, if the green LED keeps lighting then the inverter is started up and normally working on-grid.

### 6.5.2 Shut-down the Inverter

Based on actually situation, if have to shut-down the running inverter, please strictly following below procedure.

- If the EPS output is connected with sensitive loads like server, computer etc. Please firstly make sure these devices have saved its data and shut-down correctly.
- Turn off battery switch.
- Turn off DC switches.
- Turn off AC switch.
- If need to disconnect the inverter cables, please wait at least 5 min before touching these parts of inverter to take measurements of disconnection.

### 6.5.3 Restart the Inverter

Please based on your actually situation to reset the inverter follow below procedure.

- Follow the guidance shows in Chapter 6.5.2 to fully shut-down the inverter.
- Then start-up the inverter follow the procedure shows in Chapter 6.5.1 to restart the inverter.
- Verify and confirm the inverter is working normally, if not, then please refer to Chapter 8. Troubleshooting & Maintenance to fix faults and errors, then repeat step a) to c). If it still doesn't work. Then contact professional technicians for supports.

## 7. Commissioning

Make a complete commissioning of the system is necessary and will essentially protect the system against fire, electric shocks or other damages or injuries.

### 7.1 Inspection

Before commissioning, the operator or installer (qualified personnel) must inspect the system carefully and make sure:

- The system is firmly installed correctly following the contents and notifications of this manual, and there are enough spaces for operation, maintenance and ventilation.
- All the terminals and cables are in good condition without any damages.
- No items are left on the inverter or within the required clearance section.
- The PV array, battery pack is working normally, and grid is normal.

### 7.2 Commissioning Procedure

After the inspection and make sure conditions is OK, then start the commissioning of the system in following order:

- Turn on the AC switch between inverter output (AC) and the grid;
- Turn on the DC switch between inverter input and the PV array if there is, or connect the PV array output to the inverter DC input;
- Turn on the DC switch between inverter output (DC) and the battery, and then turn on the switch on battery pack (if there is). Then turn on the integrated DC switch of the inverter;
- LCD will be activated within seconds and complete the inverter setting follow the directions show in **Chapter 6.2.2 LCD Operation and Setting Guidance**.
- Starting the inverter, inverter will run into "starting" state and then "running" state, during this process the LED light should be green. If LED turns red, please recheck:
  - all the connection and installation is carried out correctly according to this manual.
  - all the settings is correctly configured according to this manual and fully matching the regulations, standards and requirements of your country and the utility grid.
  - all the switches or breakers is turn on including external and internal switches of the system.
  - the PV array, battery pack and grid is normally.
- If inverter run into "fault" state, please record the error code or fault description short term on LCD screen and refer to **Chapter 8. Troubleshooting & Maintenance** for a solution. If it finally doesn't work, contact your distributor or the manufacturer for technical support.
- Setting the monitoring system in accordance with relevant monitoring system manual instructions.
- Finish commissioning.

# 8. Troubleshooting & Maintenance

## 8.1 Troubleshooting

When faults and errors occurred, please deal with these problems following below procedures and requirements.

### 8.1.1 Introduction to LED Displays

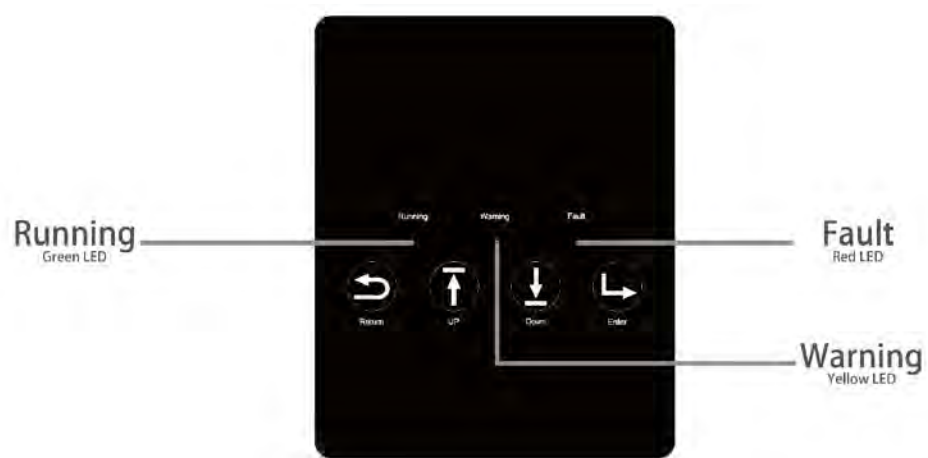

LED	Display	Description	Suggestion
Green LED	Long light	Working normally	
	Flashing	Firmware upgrading	Wait till upgrading complete
Yellow LED	Long light	Warning, inverter working	Need troubleshooting
Red LED	Long light	Fault, inverter stop work	Need troubleshooting

### 8.1.2 Troubleshooting Based On LCD Displays

Once there are any warning or fault occurred, the LED and LCD will displays information to remind the operator, the LCD will display relevant error code and short description.

Code	Description	LCD Display	Troubleshooting
E000	Internal communication fault 1	E000	Restart inverter, if the error still exist, please contact us

E016	Relay fault	E016	Restart inverter, if the error still exist, please contact us
E017	Internal communication fault 2	E017	Restart inverter, if the error still exist, please contact us
E018	Internal communication fault 3	E018	Restart inverter, if the error still exist, please contact us
E019	Bus voltage high	E019	Wait for the inverter automatically restart complete, if this error repeats for several times, please contact us
E020	EPS connection fault	EPS CN Fault	Check EPS and AC connections
E021	PV voltage high	PV voltage high	Check PV input connection
E022	Over current	E022	Restart inverter, if the error still exist, please contact us
E023	Neutral fault	Neutral fault	Check neutral connection
E024	Both PV short circuit	PV short	Disconnect both PV connection, if the error still exist, contact us
E025	Temperature over range	NTC Open	Check NTC Connection
E026	Internal fault	E026	Restart inverter, if the error still exist, please contact us
E027	Sampling inconsistent between main and slave CPU	E027	Restart inverter, if the error still exist, please contact us
E031	Internal communication fault 4	E031	Restart inverter, if the error still exist, please contact us
W000	Communication failure with battery	Bat Com Fault	Fix communication cable, if the warning still exist, contact us
W003	Communication failure with meter	Meter Com Fault	Fix communication cable, if the warning still exist, contact us
W004	Battery failure	Battery failure	Restart battery, if the warning still exist, please contact us
W005	AutoTest failure	AutoTest failure	Restart inverter, if the warning still exist, please contact us



<b>W016</b>	No AC connection	No AC Connection	Check AC connection
<b>W017</b>	AC voltage out of range	AC V Outrange	Check AC grid voltage
<b>W018</b>	AC frequency out of range	AC F Outrange	Check AC grid frequency
<b>W020</b>	PV isolation low	PV Isolation low	Restart inverter, if the error still exist, please contact us
<b>W021</b>	Leakage current high	Leakage I high	Restart inverter, if the error still exist, please contact us
<b>W022</b>	DC injection high	DC Injection high	Restart inverter, if the error still exist, please contact us
<b>W023</b>	PV short circuit	PV short	Check and fix PV input connection
<b>W025</b>	Battery voltage high	Bat Volt High	Check and fix battery connection
<b>W026</b>	Battery voltage low	Bat Volt Low	Check and fix battery connection
<b>W027</b>	Battery open circuit	Bat open	Check and fix battery connection
<b>W028</b>	EPS over load	EPS Over Load	Check and adjust EPS load
<b>W030</b>	Meter connection reversed	Meter Reversed	Check and fix meter connection

## 8.2 Maintenance

Every segment of the system need to be check monthly/quarterly/yearly according to the detailed requirements of each segment.

### Inverter Maintenance

- Check the inverter every 6 months or 1 year to verify if there are damages on cables, accessories, terminals and the inverter itself.
- Check the inverter every 6 months to verify if the operating parameter is normal and there is no abnormal heating or noise from the inverter.
- Check the inverter every 6 months to confirm there is nothing covers the inverter heat sink, if there is, shut-down the inverter and clear the heat sink.

### Battery Maintenance

As per different types battery, from the original manufacturer's requirements on maintenance, when you carried out these works on batteries, please make sure to fully shut-down the inverter for safety consideration.

## 9. Decommissioning



Please strictly follow the order of decommissioning in this chapter when you need to decommission your system, abnormal handling might cause damages or injuries from falling, electric shock or burn.

### Power Off and Dismantle the Inverter

- Turn off the internal DC switch of the inverter;
- Turn off the DC switch between battery and inverter (if the battery pack is integrated with a switch then firstly switch it to "off" to shut-down the battery in this procedure step).
- Turn off the DC switch between PV array and inverter;
- Turn off the AC switch between inverter and grid;
- Wait 5 min after turn off all these switches, then disconnect the connections in the order of AC connection, battery connection, PV connection, EPS connection, communication connection and Wi-Fi connection.
- When confirmed the temperature of the inverter and the heat sink is suitable for touching, then screw off the securing screws and hang off and remove the inverter.
- If necessary, the wall-mounting bracket could be uninstalled and removed also.

### Packaging

If possible, we recommend to use the original packaging to package the inverter and its accessories including the wall-mount bracket if the original packaging is still in well condition. But if the original packaging is missed or unavailable then you need to find a suitable packaging to instead, which meet the requirements of:

- Strong enough to Bear the weight (21 kg) of the inverter and its accessories including the wall-mount bracket;
- Easy for handle and transportation;
- Can be fully closed or packaged to protect the inverter and its accessories in case of reinstallation.

### Storing

To store the inverter please refer to relevant contents of **Chapter 3.1 Unpacking & Storing**.

### Re-install or Disposal

- If the inverter is used to be reinstalled, please refer to relevant contents of **Chapter 4. Installation** and **Chapter 5. Connection**
- When user need to dispose the inverter or related components or accessories, please strictly comply with local regulations such as waste handling regulation or pollution control regulations in case of any potential pollution.

# 10. Specification

Solar Input	3K Hybrid	4K Hybrid	4K6 Hybrid	5K Hybrid
Max. DC Input Power	6000W	7000W	7600W	8000W
Nominal DC Input Power	3000W	4000W	4600W	5000W
Max. DC Input Voltage	550V.d.c	550V.d.c	550V.d.c	550V.d.c
Nominal DC Input Voltage	360V.d.c	360V.d.c	360V.d.c	360V.d.c
DC Input Voltage Range	100 - 550V.d.c	100 - 550V.d.c	100 - 550V.d.c	100 - 550V.d.c
MPPT Voltage Range	120 - 480V.d.c	120 - 480V.d.c	120 - 480V.d.c	120 - 480V.d.c
Full-load MPPT Voltage Range	230 - 480V.d.c	240 - 480V.d.c	250 - 480V.d.c	265 - 480V.d.c
Start-up Voltage	140V.d.c	140V.d.c	140V.d.c	140V.d.c
MPPT Number	2	2	2	2
String Number per MPPT	1/1	1/1	1/1	1/1
Max. DC Input Current	7A/7A	9A/9A	10A/10A	10A/10A
Max. Short-circuit Current	10A/10A	11.5A/11.5A	12.5A/12.5A	12.5A/12.5A
Max. Input Power per MPPT	2000W/2000W	2500W/2500W	3000W/3000W	3600W/3600W

## Battery Output

Compatible Battery Type	Lithium-ion, Lead-Acid etc.	Lithium-ion, Lead-Acid etc.	Lithium-ion, Lead-Acid etc.	Lithium-ion, Lead-Acid etc.
Nominal Battery Voltage	48V.d.c	48V.d.c	48V.d.c	48V.d.c
Battery Voltage Range	42 - 60V.d.c	42 - 60V.d.c	42 - 60V.d.c	42 - 60V.d.c
Max. Charge/Discharge Current	60A/60A	60A/60A	60A/60A	60A/60A
Max. Charge/Discharge Power	3600W/3600W	3600W/3600W	3600W/3600W	3600W/3600W
Charging Curve	3 stages	3 stages	3 stages	3 stages

## AC Output

Nominal AC Output Power	3000W	4000W	4600W	5000W
Max. AC Output Power	3000VA	4000VA	4600VA	5000VA
Nominal AC Output Current	13A	17.5A	20A	22A
Max. AC Output Current	15A	20A	25A	25A
Nominal AC Voltage	230V.a.c	230V.a.c	230V.a.c	230V.a.c
AC Voltage Range	180 - 270V.a.c	180 - 270V.a.c	180 - 270V.a.c	180 - 270V.a.c
Nominal AC Frequency	50Hz / 60Hz	50Hz / 60Hz	50Hz / 60Hz	50Hz / 60Hz
AC Frequency Range	45 - 55Hz / 55 - 65Hz	45 - 55Hz / 55 - 65Hz	45 - 55Hz / 55 - 65Hz	45 - 55Hz / 55 - 65Hz
Power Factor	>0.99 @ rated power	>0.99 @ rated power	>0.99 @ rated power	>0.99 @ rated power
THDI	<3%	<3%	<3%	<3%
Paralleling Operation	Yes	Yes	Yes	Yes

## EPS Output - with Battery

EPS Nominal Output Power	3000W	3000W	3000W	3000W
EPS Nominal Output Voltage	230V.a.c	230V.a.c	230V.a.c	230V.a.c
EPS Nominal Output Frequency	50Hz / 60Hz	50Hz / 60Hz	50Hz / 60Hz	50Hz / 60Hz
EPS Nominal Output Current	13A	13A	13A	13A
Peak Power	4500W, 30s	4500W, 30s	4500W, 30s	4500W, 30s
THDV	<5%	<5%	<5%	<5%
Switching Time	<0.01s	<0.01s	<0.01s	<0.01s
Paralleling Operation	Wireless paralleling	Wireless paralleling	Wireless paralleling	Wireless paralleling

## Efficiency

Europe Efficiency	97.5%	97.5%	97.5%	97.5%
Max. Efficiency	98%	98%	98%	98%
Battery Charge/Discharge Efficiency	94.5%	94.5%	94.5%	94.5%

## Protection

Reverse Polarity Protection	Yes	Yes	Yes	Yes
Over Current/Voltage Protection	Yes	Yes	Yes	Yes
Anti-islanding Protection	Yes	Yes	Yes	Yes
AC Short-circuit Protection	Yes	Yes	Yes	Yes
Leakage Current Protection	Yes	Yes	Yes	Yes
Ground Fault Monitoring	Yes	Yes	Yes	Yes
Grid Monitoring	Yes	Yes	Yes	Yes
Ingress Protect Degree	Ip65 / NEMA4X	Ip65 / NEMA4X	Ip65 / NEMA4X	Ip65 / NEMA4X
DC Switch	Yes	Yes	Yes	Yes

## General Data

Dimensions (W/H/D)	451 / 469(551) / 184	451 / 469(551) / 184	451 / 469(551) / 184	451 / 469(551) / 184
Weight	20 kg	20 kg	20 kg	20 kg
Topology	Transformerless (solar), HF (Battery)	Transformerless (solar), HF (Battery)	Transformerless (solar), HF (Battery)	Transformerless (solar), HF (Battery)
Cooling Concept	Natural Convection	Natural Convection	Natural Convection	Natural Convection
Relatively Humidity	100%	100%	100%	100%
Altitude	<2000m	<2000m	<2000m	<2000m
Noise Emission	<25dB	<25dB	<25dB	<25dB
Standby Consumption	<5W	<5W	<5W	<5W
Display & Communication Interfaces	LCD, LED, Rs485, Wi-Fi, CAN	LCD, LED, Rs485, Wi-Fi, CAN	LCD, LED, Rs485, Wi-Fi, CAN	LCD, LED, Rs485, Wi-Fi, CAN

## Certification & Approvals

AS 4777, VDE-AR-N4105, VDE0126, G83, G59  
IEC62109-1-2, IEC62040, EN61000-6-1, EN61000-6-2, EN61000-6-3