

X60

Portable Power Bank

User Manual

Please read this manual carefully before use and keep it for future reference.



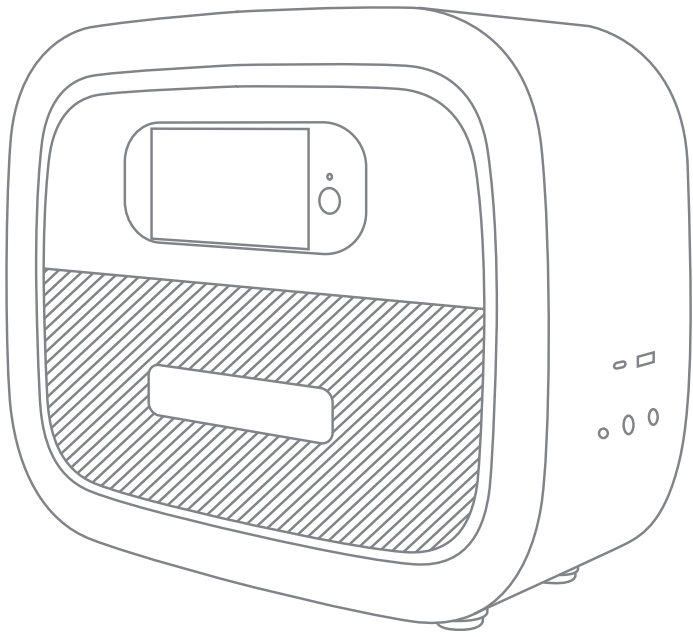

Thank You!

Thank you for making BLUETTI a part of your family.

From the very beginning, BLUETTI has tried to stay true to a sustainable future through green energy storage solutions for both indoor and outdoor use while delivering an exceptional eco-friendly experience for our homes and our world. That's why BLUETTI makes its presence in 70+ countries and is trusted by millions of customers across the globe.



Copyright © BLUETTI Corporation. All rights reserved.

No part of this document may be reproduced or transmitted in any form or by any means without the prior written consent of BLUETTI Corporation.

Trademark Declaration

 BLUETTI is a trademark of BLUETTI Corporation.

All other trademarks mentioned in this manual are owned by the trademark owners.

Notice

BLUETTI's products, services, and features are subject to the agreed-upon terms and conditions during purchase. Please note that some products, services, or features described in this manual may not be available under your purchase contract. Unless otherwise specified in the contract, BLUETTI makes no representations or warranties of any kind, express or implied, with respect to the contents of this manual.

The contents of this manual are subject to change without notice. Please get the latest version from: <https://www.bluettipower.com/pages/user-guides>

If you have any questions or concerns about this manual, please contact BLUETTI support for further assistance.

SHENZHEN POWEROAK NEWENER CO., LTD.

Address: F19, BLD No.1, Kaidaer, Tongsha Rd No.168, Xili Street, Nanshan, Shenzhen, China

Website: <https://www.bluettipower.com>

Customer Service

Tel: 800-200-2980 (Monday to Sunday 9:00-17:00)

Email: sale@bluettipower.com (Pre-sales),
service@bluettipower.com (After-sales)

Contents

1	Safety Instructions	06
1.1	General Safety	06
1.2	Storage and Usage	08
2	What's In The Box	09
3	Product Overview	11
4	LCD Screen	12
5	Operations	13
5.1	Powering On/Off	13
5.2	Charging	13
5.3	Discharging	15
5.4	Set ECO Mode	15
6	Specifications	16
7	Troubleshooting	17
8	Abbreviations	17

1. Safety Instructions

Read this manual for instructions on the proper use and safety information for the unit.

Follow the warnings and instructions marked on the unit and its accessories.

Pay attention to the "Instruction", "Caution", "Warning" and "Danger" symbols in this manual, and follow the instructions carefully to avoid injury or damage. For operations not covered in the manual, please contact our company if necessary. BLUETTI will not be responsible for unauthorized operations.

The Safety Requirements provided herein are for illustrative purposes that include but are not limited to those listed in this manual. Actual operation shall comply with all applicable safety standards.

1.1. General Safety

- Always operate or store the unit in the conditions specified in this manual.
- The installation and ambient conditions must comply with the regulations in the relevant international, national or regional standards.
- Unauthorized disassembly, alteration of the equipment or modification of the software code is not allowed.

BLUETTI shall not be liable for the following circumstances:

- Equipment damage caused by force majeure, such as earthquake, fire, storm, flood, mudslide, etc.
- Damage or loss during customer's own transportation.
- Damage caused by storage conditions that do not meet the requirements specified in this manual.
- Damage to the hardware or data of the equipment due to customer negligence, improper operation or intentional damage.
- Damage to the system caused by a third party or the customer, including handling and installation that does not meet the requirements specified in this manual.
- Damage caused by adjustment, alteration or removal of identification marks.

Regulate your operations to avoid danger:

- Do not install, use and maintain the unit in adverse weather conditions such as lightning, rain, snow and strong breezes (including but not limited to handling and operating the unit, plugging and unplugging signal connections to outdoor facilities, working at height, outdoor installations, etc.).
- Always turn off the power source before starting any electrical work.
- Do not clean the unit with water.
- Do not disassemble, modify, tamper with or repair the unit on your own.
- Regularly inspect the unit and its accessories for damage or deterioration.

- If the unit's enclosure is cracked during transportation or use, do not use it and contact BLUETTI support or your local BLUETTI dealers.
- Use a dry powder extinguisher if the unit catches fire.
- In case of fire, EVACUATE the building or affected area immediately, activate the closest FIRE ALARM system and CALL 9-1-1 or your local emergency phone number.
- Use genuine cables and accessories provided by BLUETTI.
- Keep the unit away from heat sources or high temperatures, and do not expose it to direct sunlight.
- Do not store the unit with flammable liquids, gases, or explosive materials.
- Make sure the area where you are using the unit is well ventilated and spacious.
- Do not block or cover the vents of the unit as this may cause irreversible damage to it.
- Use the unit for its intended purpose and avoid stacking objects on top of it during storage or use.
- Do not move the unit during operation as the vibrations and shocks associated with movement may cause damage to the internal hardware.
- In case of malfunction, turn off the unit immediately and contact BLUETTI support or your local BLUETTI dealers if this manual cannot adequately explain the malfunction to you.
- Do not place the unit on an unstable or inclined surface.
- Do not insert foreign objects into any port and vent of the unit.
- Keep away from children and pets.

Legal and Regulatory Requirements

- The transportation, wiring and maintenance shall comply with all applicable laws, regulations and standards.
- User-provided materials and tools required shall meet the requirements specified in applicable laws, regulations and relevant standards.

1.2. Storage and usage

- When not using the unit for over 3 months, charge it to 40% to 60% SoC to keep it in optimal condition.
- Store the unit in a cool and dry place. The ideal temperature range is 10°C to 30°C. The unit can be safely charged and discharged at temperatures of -20°C to 40°C. However, it's NOT recommended to store the unit in harsh temperatures for extended periods of time.
- Fully cycle the unit every 3 months to maintain the battery's health.
- Clean the unit with a soft dry cloth.
- Before storing the unit, power it off and remove all electrical connections from it.





⚠ If the SoC drops to 0 (during operation or upon startup), take the following actions to safely restart the unit:

- 1) Shut down immediately.
- 2) Charging within 48 hours.
- 3) Battery should be kept at an ambient temperature of 5°C to 35°C for 24 hours before charging.



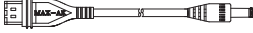

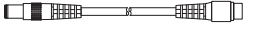
BLUETTI shall not be liable for any equipment damage caused by the violation of above instructions.

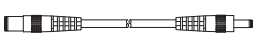
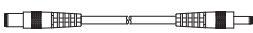
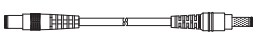
2. What's In The Box

Standard Packaging

No.	Item	Picture	Qty.
①	Portable Power Bank		1
②	DC 24V/4A Power Cable		1
③	DC 24V/4A Power Cable		1
④	DC 24V/4A Power Cable		1
⑤	DC 12V/5A Power Cable (I)		1
⑥	DC 12V/5A Power Cable (II)		1
⑦	DC 12V/5A Power Cable (III)		1
⑧	DC 16V/4A Power Cable		1

Standard Packaging

No.	Item	Picture	Qty.
⑨	DC Power Cable (Cigarette Lighter to DC 12.5V~26V/8A)		1
⑩	Connector for HP (Connecting with ③ together to power AirSense 10)		1
⑪	AC Adaptor (Wall Outlet to DC 12.5V~26V/8A)		1
⑫	Storage Bag		1
⑬	User Manual		1

3. Product Overview

X60 is a DC portable power bank with an internal integrated large capacity battery pack. With external adapter charging and car charging, LCD screen, USB-A, USB-C and 12V/16V/24V DC output, it is suitable for CPAP power supply and mobile devices charging. Refer to 6. Specifications for more details of X60.

The keys and interfaces of X60 are shown in the following figure.

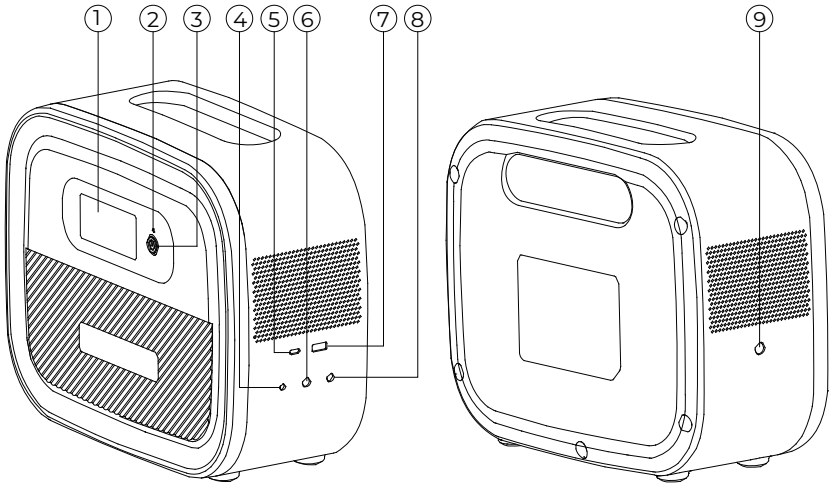

Table 3-1 Descriptions of Keys and Interfaces

No.	Name	Description
①	LCD Screen	Displays operation information e.g. SoC and charging/discharging status.
②	LED Indicator (Green)	Always on: X60 powered on; flashing: charging
③	Power Button	Hold it for 3 seconds to power on/off X60.
④	DC Output (12V/5A)	Power devices with 12V input.
⑤	USB-C Port	Power supported devices.
⑥	DC Output (16V/4A)	Power devices with 16V input.
⑦	USB-A Port	Power supported devices.
⑧	DC Output (24V/4A)	Power devices with 24V input.
⑨	Charging Port	Charge X60 through this port.

4. LCD Screen

The LCD screen is lit when X60 is powered on. If X60 is powered off, press and hold the power button for 3 seconds to turn it on. The display is shown in the following figure.

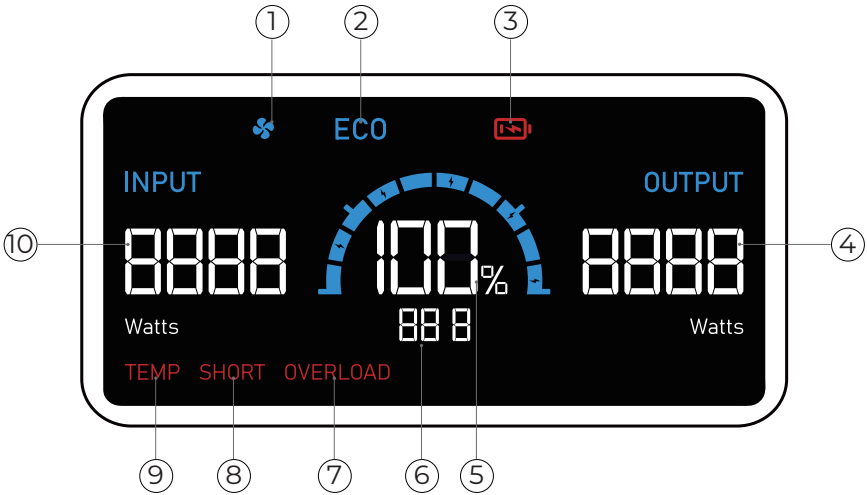

Table 4-1 Description of LCD Screen

No.	Item	Description
①	Fan Running	Displays when the fan is running. Note: The cooling fan inside X60 will run automatically when the temperature is too high, and it will automatically stop when the temperature restores.
②	ECO Mode Enabled	Displays when ECO mode is enabled. Note: The battery life can be extended under ECO Mode. It is recommended to enable this mode if X60 is kept being charged.
③	Battery Low	Displays when the battery level is $\leq 5\%$. The buzzer will continue to beep. Please charge X60 in time.
④	Output Power	The total power of the devices connected to X60.
⑤	Battery Level	The remaining battery level. Also known as SoC.
⑥	Firmware Version/ Fault Code	Firmware Version: Displayed as 00X for 3s after powering on, e.g. 008 Fault Code: Displayed as E0X after 3s of powering on, e.g. E08

No.	Item	Description
⑦	Overload	Displays when X60 is overloaded. Disconnect all the loads, and press the Power Button to clear the fault. Then reconnect the loads.
⑧	Short	Displays when a short circuit occurs. Disconnect all the loads, and press the Power Button to clear the fault. Then reconnect the loads.
⑨	Temperature Abnormal	Displays when the temperature of the battery or mainboard is too high or too low. Wait until the temperature resumes and try again.
⑩	Input Power	The charging power of X60.

5. Operations

5.1 Powering On/Off

- **Powering On:** When X60 is off, press and hold the power button for 3 seconds to power it on. The LED indicator and LCD screen will light up. If the LCD backlight is off, press the power button to light it up again.
- **Powering Off:** When X60 is on, press and hold the power button for 3 seconds to power it off. The LCD screen and LED indicator will be turned off.

5.2 Charging

X60 supports 2 ways of charging: AC adaptor and car charging.

5.2.1 AC adaptor charging

Connect one end of the adaptor to the charging port of X60, and the other end to a wall outlet. The charging will automatically stop when the battery is fully charged.

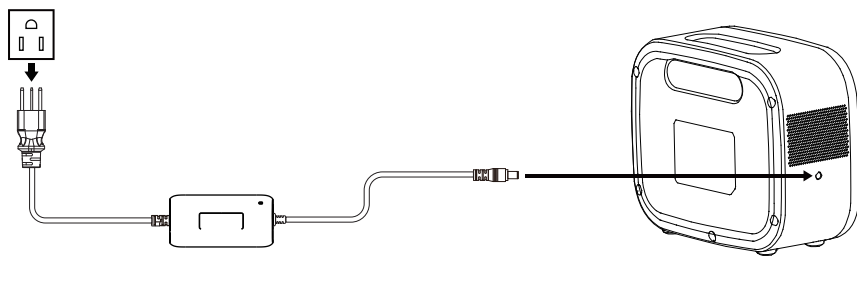

⚠ Note:

(1) X60 cannot be powered off when it is being charged.

(2) The figure  indicates that an adaptor is connected but X60 is not being

charged, and it can be turned off.

(3) The figure  indicates that there is an overvoltage of the adaptor. Please

confirm it is the original adaptor of X60.

(4) Restriction of secondary charging : When X60 is charged to 100% and the adaptor is kept connected, it will only be recharged when the battery level drops to 95%. There is no such restriction if the adaptor is replugged.

5.2.2 Car charging

Ensure the following two conditions are met when using car charging:

- Power can be output from the vehicle.
- The engine of the vehicle is running.

Connect one end of the cable to the charging port of X60, and the other end to a cigarette lighter port of the car. The charging will automatically stop when the battery is fully charged.

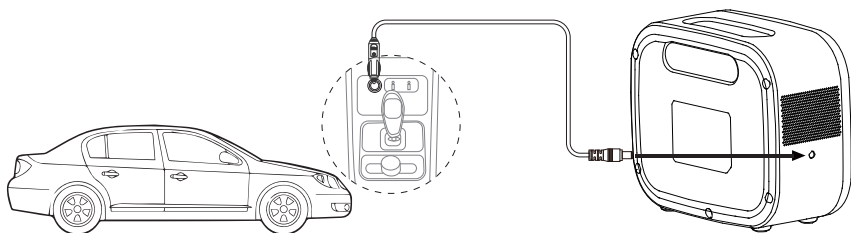

5.3 Discharging

X60 is equipped with five types of DC output ports: USB-C, USB-A, DC 12V/5A, DC 16V/4A, and DC 24V/4A.

When X60 is on, use the matching power cable to connect your device and X60.

Note:

Only one of the three ports (DC 12V/5A, DC 16V/4A and DC 24V/4A) can be used at a time.

If you need to switch output ports:

- (1) Disconnect the device currently in use on the output port.
- (2) Wait for 4 seconds.
- (3) Connect the device to the corresponding output port.

5.4 Set ECO Mode

The battery life can be extended under ECO Mode. When enabled, the battery level of X60 will remain between 60% and 70%.

It is recommended to enable this mode if X60 is kept being charged.

5.4.1 Enable ECO Mode

When X60 is powered on, press the power button twice to enable ECO mode. The ECO icon will be displayed at the top left of the LCD screen.

5.4.2 Disable ECO Mode

Disable ECO mode by either of the following 3 operations:

- Press the power button twice
- Restart X60
- Remove the X60 charger.

When ECO mode is disabled, the ECO icon disappears from the LCD screen.

6. Specifications

Item	Specification
General	
Battery capacity	614Wh
Battery cell	LiFePO ₄
Net weight	About 7kg
Dimensions	305mm×252mm×128mm
Charging temperature	0°C ~ 40°C
Discharging temperature	-20°C ~ +40°C
Storage temperature	-20°C ~ +35°C
Working humidity	5% ~ 95%
DC Output	
DC output ports	DC4017 12V/5A DC6530 16V/4A DC5525 24V/4A
USB-A	5V/3A
USB-C (Type-C)	5/9/12/15/20V 3A; 20V/5A (eMarker chip built-in)
DC Input	
Interface	DC7909
Input power	200W/8A Max
Input voltage	12.5V~26V

7. Troubleshooting

When a fault occurs, the fault code will be displayed on the screen.

Refer to Table 10-1 for details of the fault codes.

Table 10-1 Fault Codes Definition

Fault Code	Defination	Recommended Solutions
E01	Unable to charge	Restart X60
E02	Unable to discharge (DC ports)	Restart X60
E03	Unable to charge/discharge	Restart X60
E04	Unable to charge/discharge	Restart X60
E05	Unable to charge/discharge	Restart X60
E06	Unable to charge/discharge	Restart X60
E07	Unable to charge	Restart X60
E08	Unable to charge	Restart X60
E09	Unable to discharge (DC ports)	Restart X60
E10	Unable to discharge (USB-C)	Restart X60
Others	/	Contact technical support.

8. Abbreviations

- DC: Direct Current
- SoC: State of Charge

For more information, please visit:

Web: <https://www.bluettipower.com>



@ BLUETTI Support

@ BLUETTI Official



@ bluetti_inc



@bluetti.inc



@bluetti_official



service@
bluettipower.com

SHENZHEN POWEROAK NEWENER CO., LTD.

Add: F19, BLD No.1, Kaidaer, Tongsha Rd No.168, Xili Street, Nanshan, Shenzhen, China

Customer Service

Tel: 800-200-2980 (Monday to Sunday 9:00-17:00)

Email: sale@bluettipower.com (Pre-sales),

service@bluettipower.com (After-sales)

Warranty Card

Manufacture Date

Sale Date

File No.

Manufacturer

Warranty Instructions

1. 12-months warranty
2. After-Sale-Service mailbox: service@bluettipower.com
3. Following situations will go against the warranty terms:
 - A. Any problems, malfunction or damages due to incorrect using methods or caused by unauthorized disassembly or repair.
 - B. The damage caused by force majeure, fire and other extreme abnormal conditions.
 - C. Without the warranty card or the card records is not clear, complete, or without the sales company seal



BLUETTI

Certificate

Inspector: _____

QC: _____

Just Power On

P/N:17.0303.0589-04A4