

INSTALLATION AND OPERATING INSTRUCTIONS

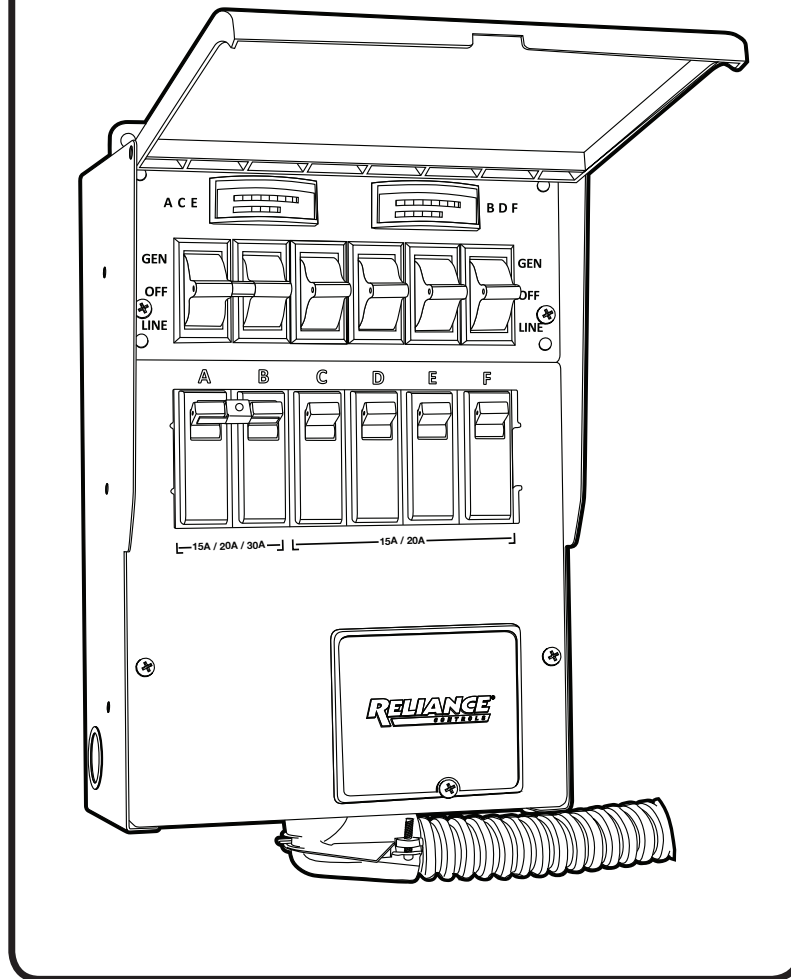

PRO/TRAN[®] 2

MANUAL TRANSFER SWITCH KITS

FROM



TABLE OF CONTENTS

	Page
Tools Needed for Installation	1
Safety Symbols Used in this Manual	1
About Generators and Transfer Switches	2
Key Product Components	3
Pre-Planning the Load on Your Generator	4
Load Balancing Examples	5
Installation Instructions	5
Mounting the Transfer Switch	6
Connecting the Flexible Conduit	6
Grounding the Transfer Switch	7
Installing 120 Volt Circuits	7
Installing 240 Volt Circuits	8
Completing the Installation	8
Installing and Wiring the Power Inlet Box	9
Wiring the Power Inlet Box to the Transfer Switch	9
Installing an Optional Power Inlet	10
Finishing Up	10
Operating Instructions	10
Product Specifications	11

Congratulations on your purchase of the Reliance Controls generator power transfer switch. Reliance has been manufacturing transfer switches and equipment in Racine, Wisconsin since 1983 and has been producing high-quality electrical equipment for over 100 years. Reliance is the Loadside® transfer switch used in nearly 90% of the installations done by professional electricians. Your transfer switch is UL 1008 listed, C-UL listed, and meets all requirements of the 2014 National Electrical Code.

All Reliance Controls transfer switches are made to operate with any generator having 20 or 30 Amp twist-lock power receptacles.

TOOLS NEEDED FOR INSTALLATION

1. Power Drill
2. Wire Stripper and Cutter (10 to 14 gauge)
3. Insulated Screwdrivers
(#2 Phillips, 1/4" Flat Tip or #2 Square Tip depending on your load center)
4. Hammer
5. Marking Pencil
6. Tape Measure
7. Seven Wall Anchors with at Least a 3/8" Flange
8. Enough 10-3 with Ground Building Wire to reach from where you install your Outdoor Power Inlet Box to where you install your transfer switch
9. Battery Powered Lighting during Installation
10. A Non-Contact Voltage Detector (optional)

NOTE: The 30 Amp power cord plugs into this type of generator power outlet:



If your generator only has a 20 Amp power outlet like this:



Certain transfer switch kits may include additional 20A plug, If your's does not please contact us so we can send one free of charge.

SAFETY SYMBOLS USED IN THIS MANUAL



DANGER

Danger indicates an imminently hazardous situation that, if not avoided, could result in death or serious injury.



WARNING

Warning indicates a potentially hazardous situation that, if not avoided, could result in death or serious injury.



CAUTION

Caution indicates a potentially hazardous situation that, if not avoided, may result in minor or moderate injury.

Transfer switches are required for use with portable generators by Article 702 of the 2002 National Electrical Code

Reliance Controls Corporation is not responsible for damage or injury caused by incorrect installation of this transfer switch.



WARNING

Improper installation of the transfer switch could cause damage or personal injury by electrocution or fire. Installation must be performed by a qualified electrician, or others knowledgeable of electrical systems, in compliance with all applicable electrical codes. Do not overload.



Member of the National Electrical Manufacturers Association

ABOUT GENERATORS AND TRANSFER SWITCHES

Generators and transfer switches are dependent on one another as a system to power your home in a power outage situation. The Reliance Controls transfer switch system is needed because 1) your portable generator is very powerful and the power it creates must be safely controlled to protect you and your electric utility provider, 2) even with all of its power, your generator probably cannot power all of the electrical circuits and devices in your home without help from a transfer switch with load management capabilities, and 3) a transfer switch is required by the National Electrical Code when installing a transfer switch to power your home's wiring.

The Reliance Controls transfer switch is designed to let you control and distribute your generator's power. It correctly distributes the power from your portable generator to your home circuitry through your electrical load center. It also eliminates the need for messy cords running to your electrical appliances through open doors and windows. The Reliance Controls transfer switch working with your generator takes the worry and inconvenience from power outage situations.

The Reliance Controls transfer switch distributes the power from your generator through its toggle switches to the corresponding selected branch circuits that power the major appliances you choose to operate during a power outage (such as your sump pump, refrigerator or furnace). However, because each of these branch circuits may power several other electrical devices other than your major appliances, such as the items plugged into wall sockets and permanently installed lighting, we recommend that you do a little pre-planning by:

1. Picking the key electrical appliances you want to power in an emergency
2. Finding the essential circuit breakers that control these devices
3. Creating a map of all of the other electrical devices plugged into or wired into these circuits

A tear-off Home Circuit Mapping Chart on the back of this manual should be completed and posted next to your transfer switch to help you in managing the load on your generator. Make sure you note on the chart which electrical devices you will not need during a power outage so that these can be turned off prior to starting your generator.

During a power outage, you can run your generator and transfer switch system in two ways:

- You can set up your transfer switch to run all of its circuits at the same time once you flip the toggles to the GEN position. Setting your system up in this way will be discussed in the "Balancing the Load" section later.
- You can also use the load management function of the Reliance Controls transfer switch that allows you to alternate the devices you choose to run at any given time. If your generator is running at or near its maximum output, selected circuits can be switched off and others can be switched on for brief periods of time. For example, you can run a microwave oven for a brief period from the transfer toggle switch that controls your microwave circuit, if you first turn off the transfer switch toggle switch that controls your furnace—for that same brief period.

Typical Generator and Transfer Switch Installations

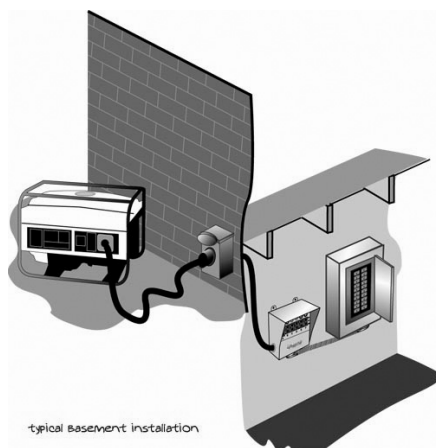

Generator Plugged into Outdoor Power Inlet
Box Wired to Transfer Switch Next to
Basement Load Center
(POSSIBLE KIT INSTALLATION)

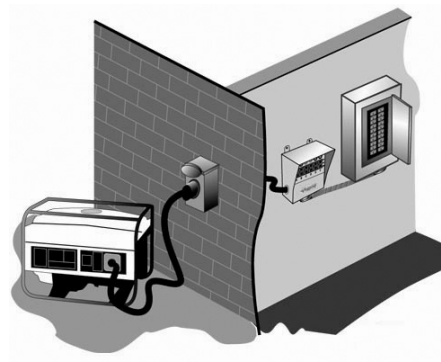

Generator Plugged into Outdoor Power Inlet
Box Wired to Transfer Switch Next to Garage
Load Center
(POSSIBLE KIT INSTALLATION)

KEY COMPONENTS OF THE RELIANCE CONTROLS TRANSFER SWITCH AND POWER TRANSFER KIT

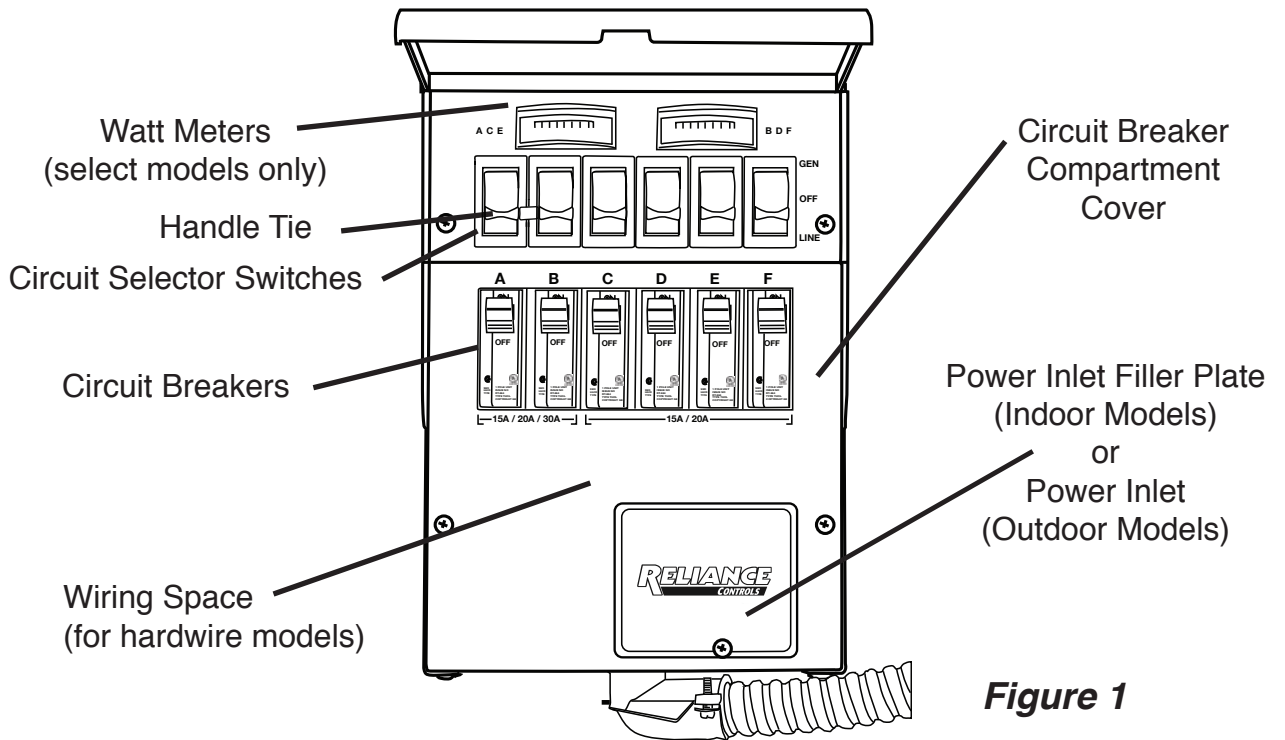

Figure 1

Circuit breakers. Each transfer switch circuit has a 1-inch interchangeable circuit breaker that protects the branch circuit when the circuit selector switch is in the GEN position. In the LINE position, each branch circuit is protected by the breaker in the load center.

Circuit selector switches. These switches allow you to select either GEN (generator) or LINE (utility) as the power source for the branch circuits that have been wired through the transfer switch. The OFF position is generally not used, as a switch in the OFF position removes that branch circuit from both utility and generator power.

Handle ties. Handle ties are used for 240-volt circuits or multi-wire branch circuits. They may be removed for 120-volt circuits. See page 8 for instructions on removing and adding handle ties.

Power inlet. (cord-connected / outdoor models only). The power cord from the generator is plugged into this inlet. This is supplied separately for indoor models to encourage the use of a remote connection outdoors reducing the likelihood of running the generator indoors which is extremely dangerous (see page 8 for installation instructions). If an indoor model is installed outdoors, make sure it is protected from the outdoor elements.

Power inlet filler plate. Models without the power inlet have a filler plate covering the hole in the wiring compartment cover. Models with a power inlet installed have a filler plate included in the carton. This can replace the power inlet for hard-wire installation.

Wiring Space. All models include wiring space that can be used to hard-wire the unit to a remote power inlet box.

Analog wattmeters (suffix C models). These meters indicate the total load, in watts, on each side of the generator when the generator is supplying power as follows:

The left meter measures the load on	
A, C, and E	6-circuit
A, C, E, G and I	10-circuit

The right meter measures the load on	
B, D and F	6-circuit
B, D, F, H and J	10-circuit

Note: The watt meters will register only if power is being used from the generator

PRE-INSTALLATION PLANNING OF THE GENERATOR LOAD

Before you begin installing your Reliance Controls transfer switch system, you need to create a plan for the appliances you choose to run during a power outage. To do this, it's helpful to first know how your generator produces power. If your generator has four-prong twist-lock 20 or 30 Amp output receptacles, and is set-up for home stand-by operation, it likely will produce 120/240 Volt power, or power similar to your electrical utility. This type of power generation is useful as it: 1) allows common 120 Volt circuits, such as lights or small appliances, to be operated, and 2) allows two 120 Volt circuits to be linked together to operate a 240 Volt device, such as a well pump.

Because of the way in which larger portable generators are designed, they generate power in two equal halves. A generator which has output of 5000 continuous running watts, for example, generates power from two 2500 watt "sides". In setting up a transfer switch to get the most power from your generator, it is desirable to "balance the load" between the two phases of your transfer switch. Devices which will consume the most of the generator's wattage should be divided between the two. Load balancing is shown in Figure 1. For example, on the 6-circuit transfer switch shown in Figure 1, consider wiring the breaker controlling the refrigerator to toggle switch E, the furnace breaker to toggle switch D, the sump pump to switch C and the breaker controlling your television to switch F. You may want to reserve switches A and B to be linked with a handle tie and wired to a double pole breaker controlling, for example, a 240 volt well pump.

The Residential Wattage Requirements Table below shows sample wattages used by typical household appliances and can help you plan the set up of your transfer switch. Use the running watts of your appliances rather than starting watts when dividing them between the two halves of the transfer switch. Check your appliances for actual wattage requirements if possible.

Your Reliance Controls transfer switch also allows you to manage the load on your generator manually by switching appliances on and off as you need them, so the capacity of either half of your generator is not exceeded. However, if you prefer not to manage your transfer switch loads manually, leave a buffer equal to the largest start-up wattage requirement of all of the appliances you are going to run continually when doing your calculation. This buffer, along with the peak wattage of your generator, will allow for the periodic motor start-up of any one large appliance, such as your refrigerator. If your transfer switch is equipped with watt meters, you can visually monitor the amount of wattage being used by the appliances your generator is powering at any time.

Examples of load balancing calculations are shown on the worksheets on page 5. Use these to create your own plan.

TYPICAL RESIDENTIAL WATTAGE REQUIREMENTS		
Appliance	Running Wattage	Additional Start-Up Wattage
Furnace (1/3 HP)	700	1,400
Furnace (1/2 HP)	875	2,100
Window Air Conditioner		
6000 BTU	1,200	2,100
12,000 BTU	1,700	2,900
Well Pump (1/3 HP)	750	1,400
Well Pump (1/2 HP)	1,000	2,350
Sump Pump (1/3 HP)	800	1,300
Sump Pump (1/2 HP)	1,050	2,150
Refrigerator	800	2,300
Garage Door Opener (1/4 HP)	550	1,100
Garage Door Opener (1/3 HP)	750	1,400
Home Security System	200	0
Lights	On Bulb	On Bulb
Stereo	200	0
TV/VCR	200	0
Computer	200	0
Microwave	Check oven	Check Oven
Coffee Maker	1,750	0
Toaster	1,300	0
Electric Fan	200	0
Clothes Washer	1,150	2,300
Clothes Dryer (Gas)	700	1,800
Dishwasher (Cool Dry)	700	1,400
Dishwasher (Hot Dry)	1,450	1,400
Vacuum Cleaner	1,000	0
Hair Dryer	Check Dryer	Check Dryer
Iron	1,200	0
Circular Saw	800	2,000

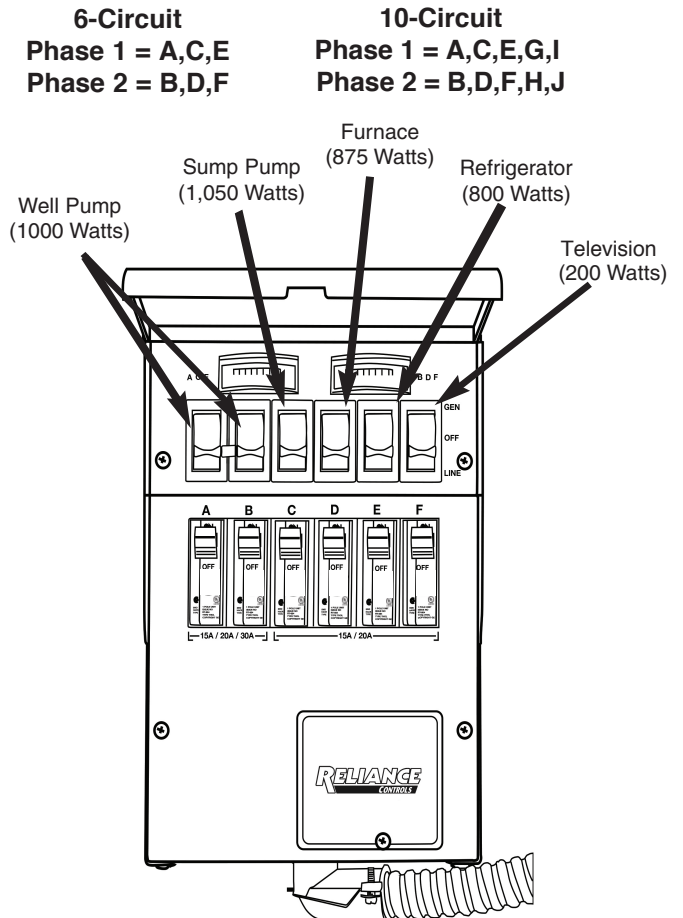

Load Balancing Example #1

Circuit Breaker Connections: Six (6) 120 Volt Single Pole Circuit Breakers
Generator: 5,500 Running Watts, 6,200 Peak Watts
Transfer Switch Model: 6-Circuits

Side One				Side Two			
Toggle Switch	Main Appliance Hooked Up	Appliance Running Watts	Additional Start-Up Watts	Toggle Switch	Main Appliance Hooked Up	Appliance Running Watts	Additional Start-Up Watts
A	Refrigerator	800	2,300	B	Furnace	700	1,400
C	Sump Pump	800	1,300	D	TV, VCR, Computer	600	0
E	Indoor Lighting	300	0	F	Security, Lighting	500	0
Total Running Watts Side One: 1,900				Total Running Watts Side Two: 1,800			

Total Side One and Side Two Running Watts	3,700
Highest Additional Start-Up Wattage of all of the Appliances (Refrigerator)	2,300
Total Watts of Load	6,000
Peak Wattage Rating of Your Generator	6,200

You're OK!

Load Balancing Example #2

Circuit Breaker Connections: Four (4) 120 Volt Single Pole Circuit Breakers and One (1) 240 Volt Double-Pole Circuit Breaker (Toggles A & B Together)
Generator: 5,500 Running Watts, 6,200 Peak Watts
Transfer Switch Model: 6-Circuits

Side One				Side Two			
Toggle Switch	Main Appliance Hooked Up	Appliance Running Watts	Additional Start-Up Watts	Toggle Switch	Main Appliance Hooked Up	Appliance Running Watts	Additional Start-Up Watts
A	Refrigerator	800	2,300	B	Furnace	700	1,400
C	TV, VCR, Computer	600	0	D	Sump Pump	800	1,300
E	Well Pump	500	1,175	E	WellPump	500	1,175
Total Running Watts Side One: 1,900				Total Running Watts Side Two: 2,000			

Total Side One and Side Two Running Watts	3,900
Highest Additional Start-Up Wattage of all of the Appliances (Refrigerator)	2,300
Total Watts of Load	6,200
Peak Wattage Rating of Your Generator	6,200

You're OK Again!

INSTALLATION INSTRUCTIONS

A. Mounting the Transfer Switch

1. Position the transfer switch so that its bottom center is about 18 inches from the bottom center of your load center. The end of the flexible conduit whip should be lined up with a 3/4" knockout hole on the bottom of your load center (Figure 2).
2. Mark the position of the holes on the four external feet with a pencil.
3. Anchor the transfer switch to the wall with four appropriate anchors (with a flange of at least 3/8").

NOTE: Do not attempt to bend the flexible conduit whip beyond its structural capabilities.

B. Connecting the Flexible Conduit Whip to Your Load Center

1. Set up battery-powered lighting to clearly illuminate your work area.
2. Turn off the main utility breaker (Figure 3).



DANGER

Even with the main power switch turned off, the wires on the utility side of the main breaker are still live and contact with them can cause serious injury or death.

3. Remove the cover of your load center. Keep in mind that the wires on the utility side of the main breaker are still live and if contacted could cause serious injury or death. If available, use a non-contact voltage detector to insure that the power is off on the non-utility side of the main breaker.
4. Remove the appropriate knockout hole in the bottom of your load center with a screwdriver and hammer. (See step A-1 above.)
5. Insert all of the wires extending from the end of the flexible conduit whip through the knockout hole. Snap the conduit connector attached to the whip into the knockout hole.

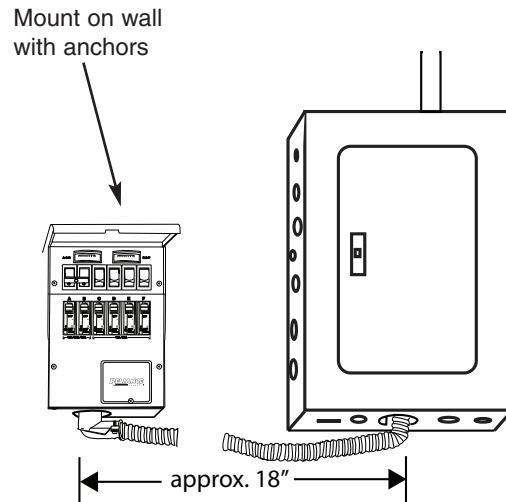

Figure 2

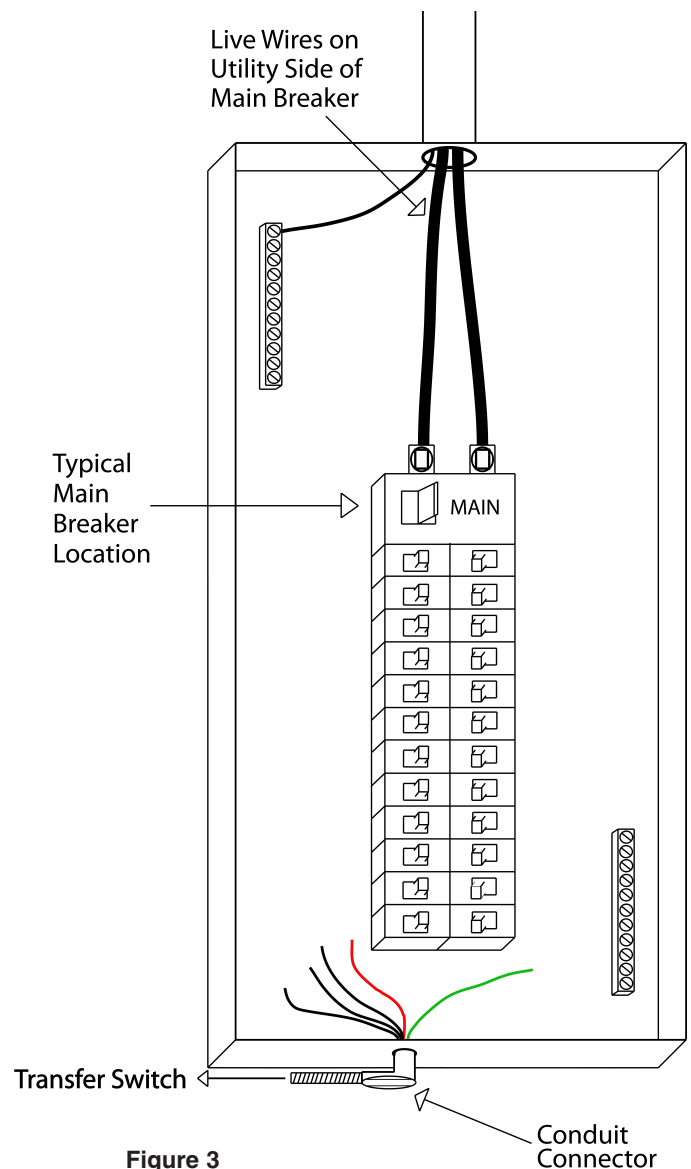

Figure 3

Conduit Connector

C. Connecting the Neutral and Ground Wire

1. Find the white wire (Neutral) and the green wire (ground) among the wires from the transfer switch that you have inserted into the load center.
2. Strip approximately 5/8" from the end of the white wire. Locate the neutral bar and partially unscrew a terminal screw on the bar. Insert the stripped end of the wire into the side of the bar under the screw and retighten the screw. (Figure 4)
3. Locate the ground bar. (It should be labeled.) Connect the green wire to the ground bar in the same way as in step #2. In service entrance load centers, the ground bar and neutral bar are frequently the same; if so, the ground and neutral wires can be connected to either.

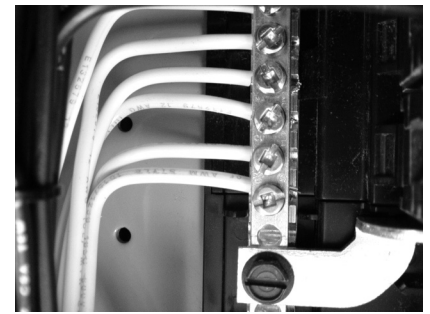

Figure 4

D. Installing 120 Volt Circuits

This section provides instructions for connecting the wires from your transfer switch to the circuit breakers in your load center which control your appliances.

You should refer to the load planning you did previously to insure that side #1 and side #2 of the transfer switch are balanced. Wire the circuits, starting with toggle Switch C.

If a selected circuit is part of a multi-wire branch circuit, insure the other branch circuit that shares the neutral is also connected to the transfer switch. The two circuits must be connected to opposing legs (phases) of the generator power and a handle tie must be installed on the switch handles so that both legs are transferred at the same time.



WARNING

Failure to properly install a multi-wire branch circuit could result in overloading the neutral wire.

If you will not be installing any 240 Volt or multi-wire circuits, remove the factory-installed handle tie(s) on the unit (See Page 8)

Lets assume that, according to your load balancing plan, you will use Switch C to supply power to the Furnace (Figure 5)

1. Turn off the refrigerator circuit breaker. Disconnect the wire that is attached to the circuit breaker.
2. Find the black and red wires from the transfer switch marked C.
3. Cut the red wire at a length convenient for it to reach to the refrigerator circuit breaker. Strip 5/8" from the end of the wire. Connect the red wire to the refrigerator circuit breaker and retighten the screw on the breaker.
4. Cut the black wire from the transfer switch to a length convenient for attaching it to the wire you removed from the refrigerator circuit breaker in #1. Strip 5/8" from the end of the wire.
5. Insert both wires—the one removed from the refrigerator circuit breaker and the black wire for Switch A—into a yellow wire connector. Tighten the connection and push the connected wires back into the wiring compartment of the load center.



WARNING

When Installing 120 Volt Circuits

The transfer switch circuits with 20 Amp breakers must be connected only to branch circuits with 20 Amp breakers in the load center. Do not connect transfer switch circuits to any branch circuits greater than 20 Amps, except circuits A & B which may be connected to 30 Amp circuits.

NOTE: The transfer switch circuits with 15 Amp breakers can be connected to branch circuits with either 15 or 20 Amp breakers in the load center.

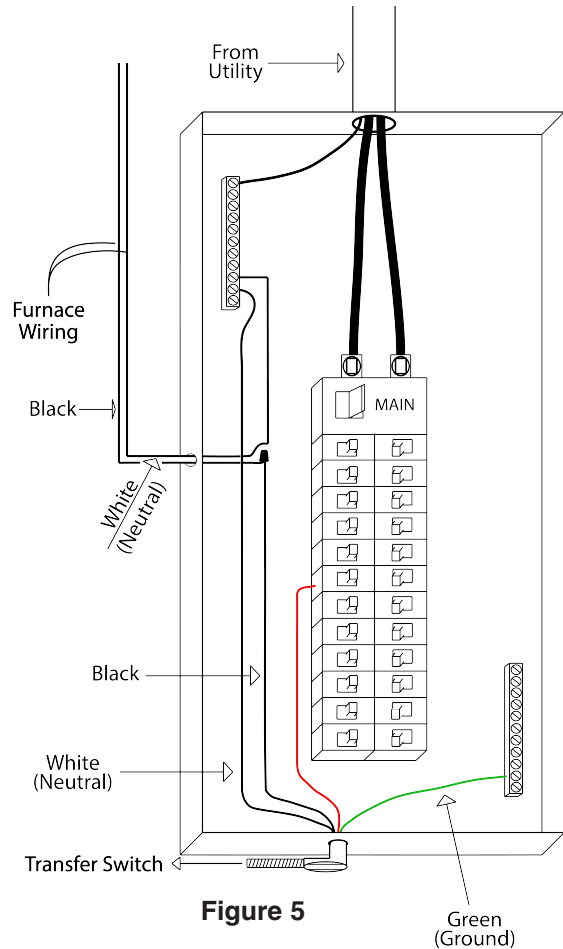

Figure 5

This completes the connection of Switch C for your refrigerator. Label Switch A as "REFRIGERATOR" on the identification pad on top of the transfer switch.

6. Repeat Steps 1 through 5 for each of the remaining switches on your transfer switch according to your load balancing plan, taking into account the following:
 - See the next section for installing 240-Volt Circuits
 - Remember to "Balance the Load", dividing appliances with higher wattages between each phase of the transfer switch.

E. Installing 240 Volt Circuits

Reliance Controls 6-Circuit Transfer switch (In Kit) is shipped from the factory with one installed handle tie on two adjacent circuits.

Let's assume that, according to your set-up plan, Switches A & B on the 6-Circuit transfer switch will be used to supply power to your well pump, a 240 Volt appliance. (Figure 6)

1. Find the two red and the two black wires marked A & B.
2. Turn off the double pole breaker for the well pump in the load center.
3. Disconnect the two installed wires on the double pole breaker.
4. Cut the two red wires from Switches A & B at a length convenient for them to reach to the double pole breaker. Strip 5/8" from the end of each red wire. Connect both red wires to the double pole circuit breaker in place of the wires you just removed from that breaker. It doesn't matter in what order.
5. Cut the black wires marked A & B to a length convenient to reach to the wires you removed from the double pole breaker in #3. Strip 5/8" from the end of each wire.
6. Connect one of the wires you removed from the double pole breaker in #3 with one of the black wires (either A & B) with a yellow wire connector. Similarly, connect the other wire you removed with the remaining black wire with a wire connector.

F. Completing the Installation of the Transfer Switch

When you have wired all of the circuits from the transfer switch into your load center and have properly installed the green and white wires to ground the unit, you have finished the installation.

Just a few more steps to wrap things up.

1. Replace the cover of the load center.
2. If you have not already done so, fill in the chart on the top of the transfer switch to identify your emergency circuits and the toggle switches they correspond to.
3. Do not turn the main and individual circuit breakers in your load center back on until you have installed all other transfer switch components in Sections G, H and I which follow.



WARNING

When Installing 240 Volt Circuits

The transfer switch circuits with 20 Amp breakers must be connected only to branch circuits with 20 Amp breakers in the load center. Do not connect transfer switch circuits to any branch circuits greater than 20 Amps.

NOTE: The transfer switch circuits with 15 Amp breakers can be connected to branch circuits with either 15 or 20 Amp breakers in the load center.

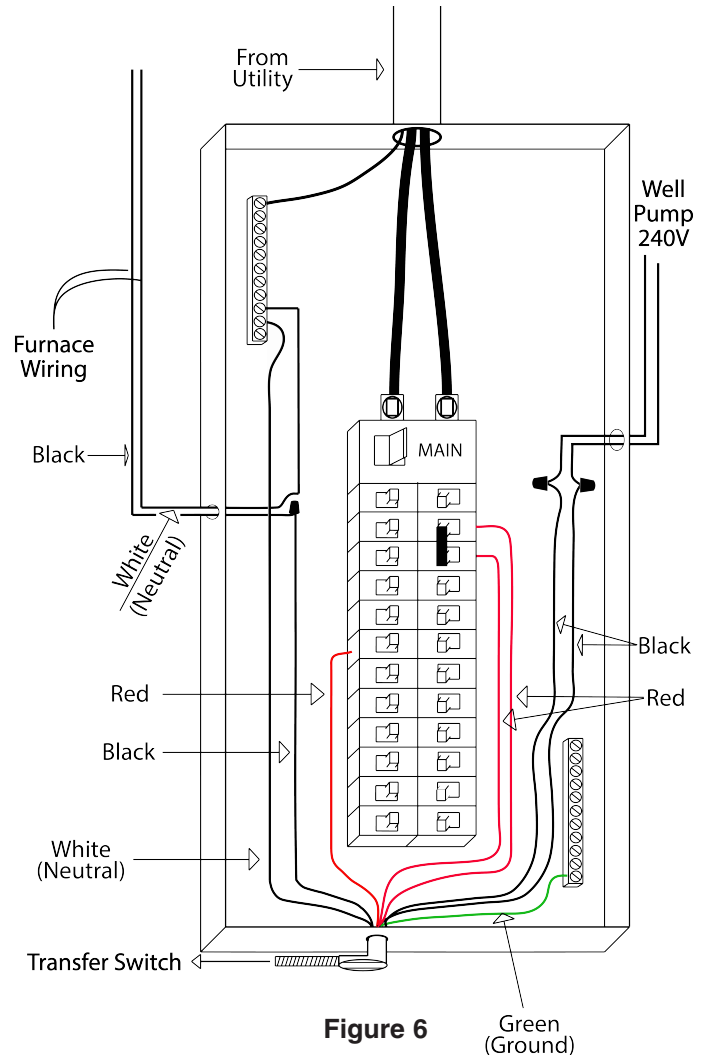

Figure 6

Removing handle tie(s). If there are no 240-volt or multi-wire circuits in the transfer switch installation, handle-ties on the switches are not needed. To remove a handle tie, place the handle-tied switches in a position opposite of the other switches. Rotate the cylindrical spacer between the switches upward repeatedly until the threaded shaft is exposed on the right switch. Grab the threaded shaft and continue to rotate the spacer upward until the spacer is free, being carefully not to drop the spacer when it becomes free. Remove the shaft from the switch. If the shaft is not exposed after several revolutions of the spacer, insert a small slot screwdriver in the hole in the right switch and continue rotating the spacer upward while the screw driver prevents the shaft from rotating.

Adding handle ties. If additional ties are needed to accommodate additional 240-volt or multi-wire circuits, they can be added to adjacent pairs of switches.

G. Installing and Wiring the Outdoor Power Inlet Box (included in kit)

Since you will be operating your generator outdoors in a location remote from your electrical load center, it is recommended that you install an outdoor power inlet box on an exterior wall of your house. Because it is hardwired directly to your transfer switch, the power inlet box gives you the flexibility to locate your generator just about anywhere.

Reliance Controls Power Inlet Boxes are UL listed and can be used with the following generator and building wire sizes:

Generator Size	Power Inlet Box	Building Wire (100' or less)
Up to 7500 (Running Watts)	PB30 (In kit)	10 gauge

To install a Reliance Power Inlet Box (Figure 8):

1. Loosen the screw at the bottom front of the box and lift off the cover.
2. Choose which knockout hole on the box is most convenient to where you will be running the building wire into your house. Remove the knockout with a screwdriver and hammer.
3. Plan to run enough building wire (check electrical codes for the need for conduit) to reach your transfer switch, allowing extra length for ease of wiring at the transfer switch end.
4. Using approved wiring methods, place a cable or conduit connector (check codes) in the inlet box knockout hole and run enough building wire into the box to allow easy wiring. Tighten the connector.
5. Mount the back plate of the power inlet box where it will be convenient. Use the three holes in the plate.
6. Strip 5/8" from each building wire lead. Loosen the green grounding screw on the inside of the box and insert the stripped end of the building wire ground under one side of the grounding screw and retighten.
7. On the bottom of the inlet plug, insert the white wire into the hole marked "W" and tighten the screw on the side of the plug. Do the same with the red wire into the hole marked "X" and the black wire into the hole marked "Y".
8. Replace the cover of the power inlet box and tighten the screw.

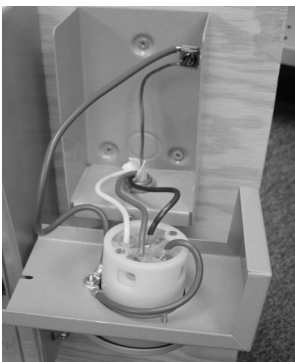

Figure 8

H. Wiring the Power Inlet Box to the Transfer Switch

All Reliance Controls transfer switches are designed to allow hardwiring between the outdoor power inlet box and the transfer switch's internal wiring compartment. This installation is the most efficient, eliminates the need for longer generator power cords running through your home to your transfer switch and eliminates the need for an additional junction box.

To hardwire your transfer switch to the building wire from the power inlet box (Figure 9):

1. Remove the front bottom wiring compartment cover plate of the transfer switch by unscrewing the two screws securing the plate and then pulling out on the bottom of the plate. Once the plate is removed, the wire leads necessary to connect the incoming building wire can be easily accessed.
2. Punch out the knockout hole on the side of the transfer switch wiring compartment.
3. Using approved wiring methods, place a cable or conduit connector (check electrical codes) in the knockout hole, and pull enough building wire into the inside of the wiring compartment to provide sufficient working length. Tighten the connector.
4. Complete the wiring by pushing the wires back into the unit, putting the wiring compartment cover back in place and replacing the screws that hold the cover plate.

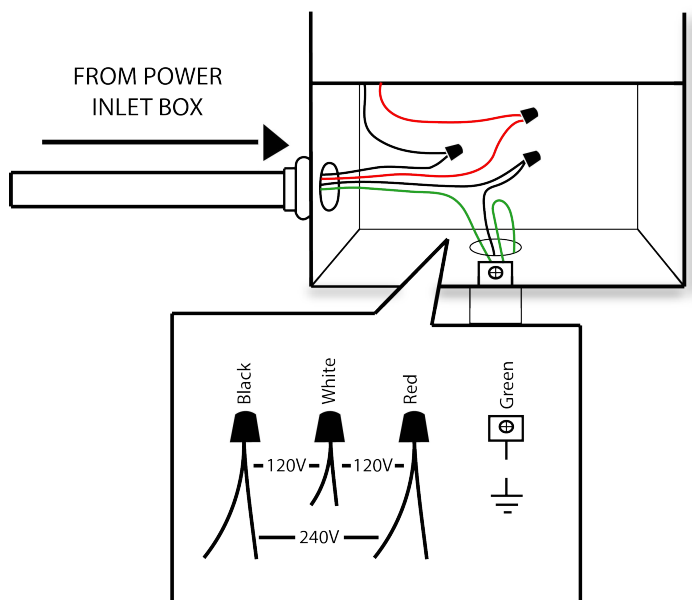

Figure 9

I. Finishing Up

According to your individual installation requirements, after you have completed all the steps necessary in Sections G through I, complete the system installation by doing the following:

1. Turn on all of the circuit breakers in your load center.
2. Turn on the main breaker.
3. Position all switches on the transfer switch to the LINE position.
4. **IMPORTANT!** In order to insure that all wiring connections have been properly completed and that your system functions properly under generator power, it is important to test each circuit before turning on any devices or appliances connected to that circuit. Correct voltage output can and should be checked with a voltage meter at any convenient electrical outlet on each branch circuit that is wired through the transfer switch. This should be done under generator power with the appropriate circuit breaker switch in the “GEN” position.

OPERATING INSTRUCTIONS



WARNING

Do not operate your generator in an enclosed area.

You want your generator to be ready when you need it – so, it is important to perform the following steps once a month:

- Start and run generator power through your transfer switch circuits.
- Keep your fuel tank filled with fresh fuel.

With your Reliance Controls transfer switch installed, it is not necessary to turn off any of your load center breakers when starting your generator, even when utility power is fully functional. This is because the double throw break-before-make action of the transfer switch prevents feeding generator power to the utility and, conversely, prevents feeding utility power back to your generator.

A. Transferring from Utility Power to Generator Power in an Emergency

1. Make sure that all switches on the Reliance Controls transfer switch are in the LINE position.
2. Plug the male end of your power cord into the generator. NOTE: If your generator has only 20 Amp 125/250 V output receptacles, replace the 30 Amp male end of the power cord with the 20 Amp male plug end supplied in the kit. See installation instructions with the 20 Amp plug.
3. Plug the female end of your power cord into either the outdoor power inlet box or directly into the transfer switch, depending on how you installed your system.
4. Start your generator outdoors and let it warm to a point where it is running evenly.
5. Turn the toggle switches on your Reliance transfer switch to the GEN position one at a time.

If you have a Reliance transfer switch with wattmeters, you can monitor the wattage load on your generator.

B. Transferring back to Utility Power When the Power Is Restored

1. Move all switches on the Reliance Controls transfer switch back to the LINE position.
2. Turn off your generator.
3. Unplug your power cord and store it.

TRANSFER SWITCH PRODUCT SPECIFICATIONS

Model Number	306C	310C
Maximum Running Watts	7500	7500
Max. Single-Pole Circuits	6	10
Max. Double-Pole Circuits	3	5
Max. Combined Load@125VAC	60A	60A
Max. Combined Load@250VAC	30A	30A
Max. Load/Circuit from Generator	2/30A 8/20A	2/30A 8/20A
Max. Load/Circuit from Load Center	30A	30A
Power Inlet / Plug Config. (NEMA)	N/A	N/A
Minimum Recommended Cord Size	10 Ga.	10 Ga.
Conduit Length (inches)	16"	16"
Conduit, Trade Size	3/4"	1"
Wattmeters	Yes	Yes
Shipping Weight, Lbs.	17	21
Dimensions H x W x D (inches)	11.25 x 7.75 x 4.5	11.25 x 11.75 x 4.5
Cabinet Type, NEMA	1	1

HOME CIRCUIT MAPPING CHART										
	A	B	C	D	E	F	G	H	I	J
Controls these essential appliances I will need during a power outage										
So I will need to turn these other devices off which are on the same circuits										
6-CIRCUIT							8-CIRCUIT		10-CIRCUIT	

This toggle switch on my generator transfer switch

**Additional products are available through your local distributor.
Call Reliance Controls at (800) 634-6155 to locate the distributor nearest you.**

Five Year Limited Warranty

Reliance Controls Corporation ("Reliance") warrants this Protran® Manual Transfer Switch ("Switch") to be free from failure to perform as intended due to defects in materials and workmanship for a period of five (5) years from date of purchase, provided the Switch has been installed and used in accordance with manufacturer's instructions and has not been subjected to misuse, alteration, accident, or repair not performed by Reliance. If, within such warranty period, the original purchaser gives written notice to Reliance at the address shown below and the Switch has been proven to Reliance's reasonable satisfaction to be defective, then Reliance at its sole option shall either: (i) supply a replacement component(s) for the defective component(s) or (ii) repair or replace the Switch. Reliance's obligation is strictly limited to said repair or replacement of the Switch, and Reliance shall not be liable for any incidental, special or consequential damages. The cost of labor to remove or install a replacement component or Switch is not included in this warranty. The foregoing warranty is exclusive and in lieu of all other expressed or implied warranties, if any, including but not limited to implied warranties of merchantability and fitness for a particular purpose. Reliance strongly recommends that the purchaser seek the advice of a licensed electrician to determine the suitability of this product, and for its proper installation in accordance with all applicable state and local building codes. This warranty gives you specific legal rights, and you may have other rights which vary from state to state.

Reliance Controls Corporation 2001
Young Court
Racine, WI 53404

Warranty registration can be completed online at **www.reliancecontrols.com**

To do so simply mouse over the "Customer Support" tab, then select "Warranty Details and Registration".

Date of purchase _____
Product purchased _____
Serial number of product _____



Reliance Controls Customer Service: (800) 634-6155

Website: www.reliancecontrols.com