

Pixio

PX277

Pixio

RED TEAM

www.pixiogaming.com

JOIN THE RED TEAM !

- Get all the latest updates and exclusive promotions
- Chances to win monthly, free giveaways



Brand: Pixio
Product Name: 27inch WQHD Gaming Monitor
Product Code: New PX277 SKU: PX277-N
FCC ID: DEFD1708122

This device complies with part 15 of the FCC Rules. Operation is subject to the following two conditions: (1) this device may not cause harmful interference, and (2) this device must accept any interference received, including interference that may cause undesired operation.
Any changes or modifications not expressly approved by the party responsible for compliance could void the user's authority to operate the equipment.



NOTE: This equipment has been tested and found to comply with the limits for a Class B digital device, pursuant to Part 15 of the FCC Rules. These limits are designed to provide reasonable protection against harmful interference in a residential installation. This equipment generates, uses and can radiate radio frequency energy and, if not installed and used in accordance with the instructions, may cause harmful interference to radio communications. However, there is no guarantee that interference will not occur in a particular installation.

If this equipment does cause harmful interference to radio or television reception, which can be determined by turning the equipment off and on, the user is encouraged to try to correct the interference by one or more of the following measures:

- Reorient or relocate the receiving antenna.
- Increase the separation between the equipment and receiver.
- Connect the equipment into an outlet on a circuit different from that to which the receiver is connected.
- Consult the dealer or an experienced radio/TV technician for help.

FCC ID: DEFD1708122

/ WARNING /

- Make sure the monitor is not placed near any source of water, such as the bathroom, kitchen, or humid areas.
- Do not place the monitor on an unstable, or uneven surface. If dropped, the monitor may cause bodily injuries. When transporting the monitor, make sure it is secured in an upright position or preferably in its original packaging for best results. When mounting the monitor, make sure to follow the instructions of the respective mounting provider for best results.
- The openings in the monitor are for ventilation. For best results, make sure the ventilation holes are not covered up. Avoid confined spaces like a bookcase for proper functionality.
- If the monitor will not be used for an extended period of time, make sure to unplug the power cord to prevent the risk of damage from lightning strikes or other abnormal voltage incidents.
- Do not overburden any socket to prevent risk of fire or shock.
- Do not stick any foreign objects into the monitor to prevent risk of fire or shock.
- Please do not try to take off the back panel to repair the monitor yourself. You may run the risk of shock and void the warranty as well. Contact Pixio directly for all RMA issues.
- Take note of elevation and temperature zone warnings on the adapters.
- The  icon, indicates that the adapter is suited for areas under 2000 meters.
- The  icon, indicates that the adapter is suited for non-tropical areas.

/ GENERAL NOTICE /

- Do not place the monitor near heat sources, such as radiators, and do not expose the monitor to direct sunlight for an extended period of time.
- Make sure to keep the original packaging material. If there are any needs to transport the monitor, the packaging material will be the best method for successful delivery.
- Make sure to use a soft, non-abrasive cloth when cleaning the monitor. Do not use corrosive or strong detergents to clean the monitor. They may result in permanent damage to the panel and will void the warranty.
- Always check to make sure the power cord is unplugged before cleaning the monitor.
- Be careful when handling liquids while cleaning as it may cause irreparable damage to the electrical components in the monitor.

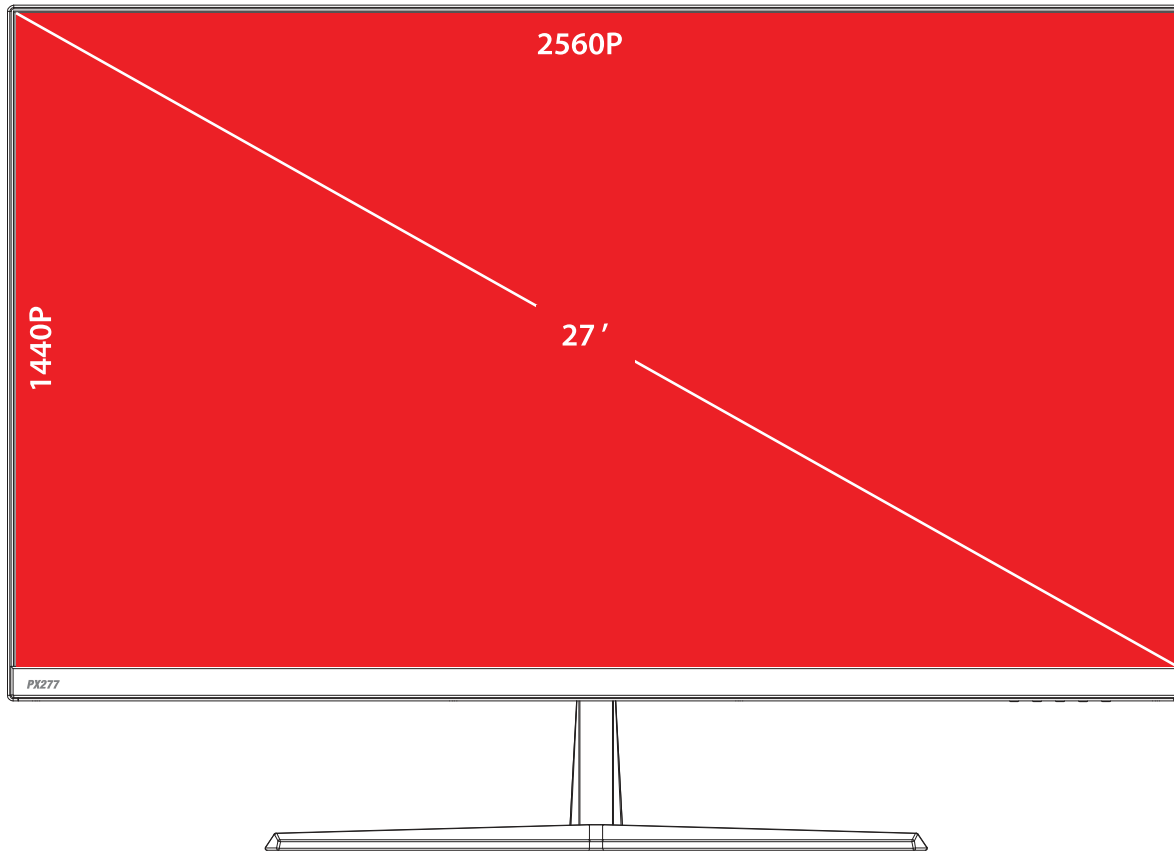

Pixio
PX277

Features:

Bezel-less Design
WQHD Resolution (2560 x 1440)
144Hz Refresh Rate
IPS (AH-VA) - 178° Viewing Angle
6ms Response Time (Overdrive)
FreeSync™ Technology
1000:1 Contrast Ratio
Low Blue Light Mode
Gaming Mode
Built-in Crosshairs
VESA 75 x 75 Standard

Characteristics of Crystal Display Monitors

When the following potential issues occur, please be aware that the monitor is functioning in accordance of manufacturing tolerances and does not mean the monitor has a defect.

- When first turning on the monitor, the screen may flicker. Please turn the monitor off and turn it back on.
- The brightness levels on different images may appear uneven.
- The effective pixel count should approximate 99.99%, but there may be a possible 0.01% or less failure rate due to dead or stuck pixels.
- If the monitor displays a single static image for a long period of time, there may be an image burn that can be seen while viewing a different image. The burned image will gradually disappear and turning off the monitor for an extended period of time will speed up the process.
- If you notice extended, constant flickering or if the screen constantly goes to black, please contact Pixio directly and we will assess and have the unit repaired if necessary. Please do not attempt to repair the unit yourself as it will result in voiding the warranty.

For Warranty information please visit <https://pixiogaming.com/pages/warranty>

// DIMENSIONS & WEIGHT //

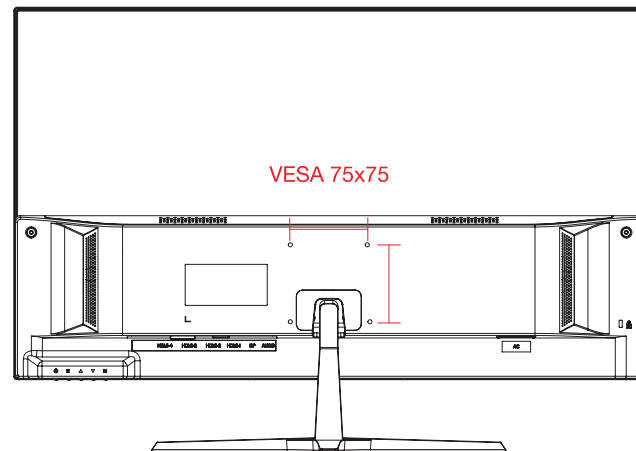
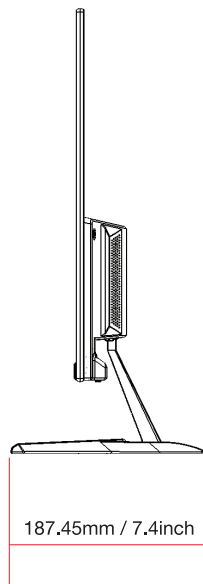
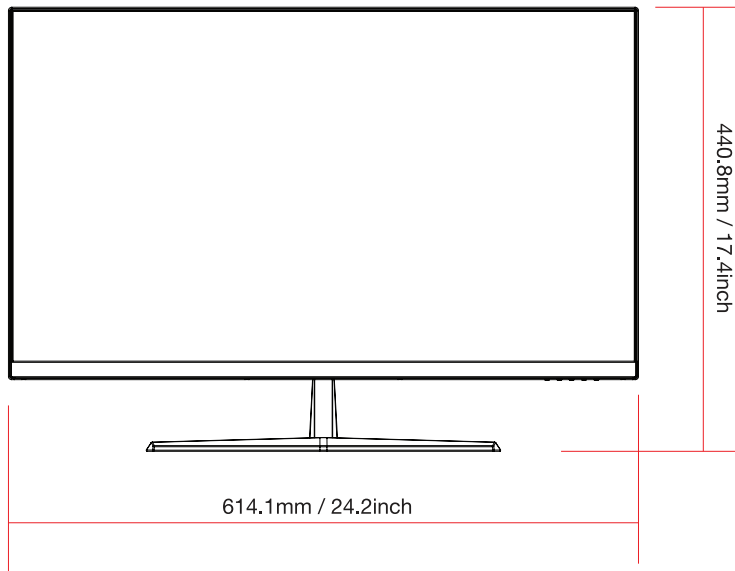

4.65kg = 10.25lb
with stand

// PACKAGE INCLUDES //



27inch Monitor

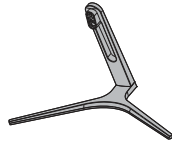

Stand

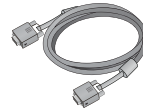

DP Cable



Power Cable

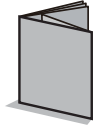

User Manual

* User manual can be downloaded at <https://pixiogaming.com/pages/downloads>

*If any of the provided items are missing, please contact us at cs@pixiogaming.com and we will help provide you with the necessary items.

/ MONITOR INPUTS /

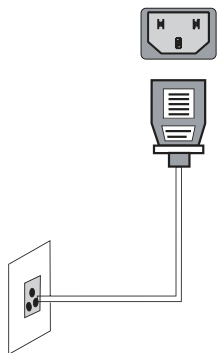
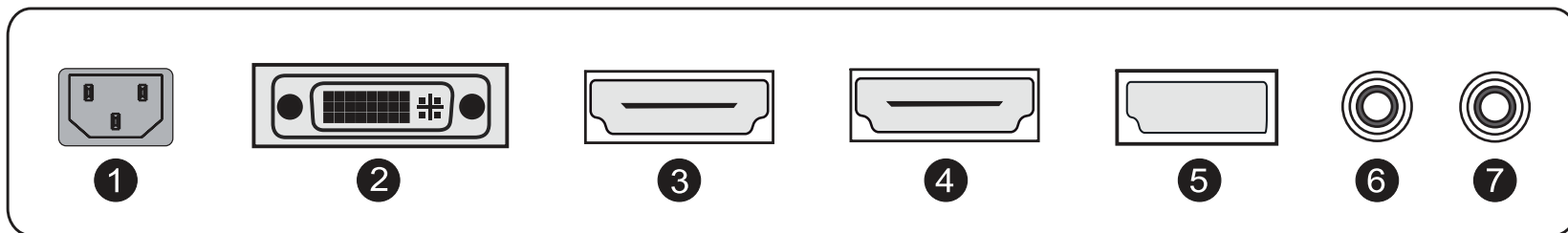

Monitor has a built-in power supply

***WARNING:** Always use the appropriate power cord.

- ① POWER PLUG
- ② DVI PORT
- ③ HDMI 1.4 PORT
- ④ HDMI 2.0 PORT (144hz)
- ⑤ DP 1.2 PORT (144hz & Freesync)
- ⑥ AUDIO IN

To use the monitor's built in speakers using a DVI Cable, please use a 3.5 mm to 3.5 mm audio cable to connect to your computer directly.

- ⑦ AUDIO OUT

PLEASE USE A DP CABLE FOR 144Hz & FreeSync™

// OSD MENU //

1. Schematic Diagram of Keys

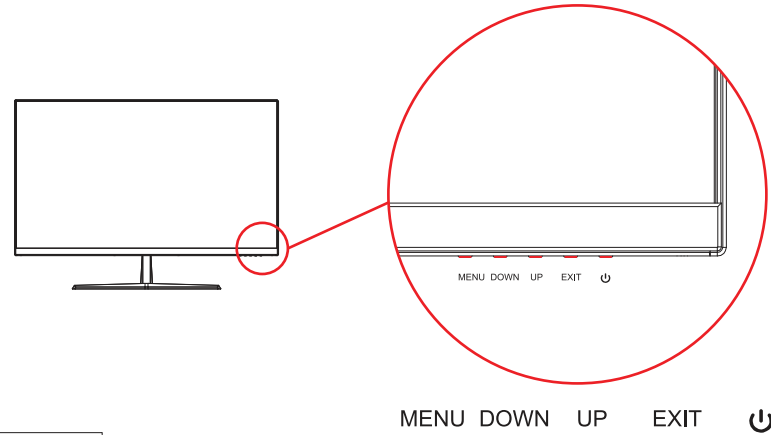
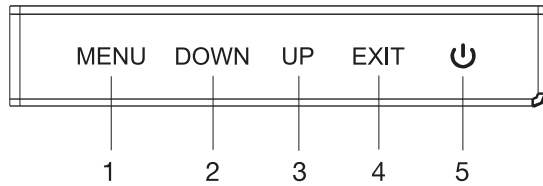

2. Description of Keys Functions

1.	MENU	Opens the main OSD menu and acts as the select key
2.	DOWN	Navigate down or decrease a menu item on the OSD menu, or adjust the dynamic contrast ratio
3.	UP	Navigate up or increase a menu item on the OSD menu, or adjust the ECO mode
4.	EXIT	Functions as the back key and exits the main OSD menu
5.	⏻	Powers the monitor on and off

// OSD MENU //



CURRENT MODE

DP - Input Source
2560x1440 - Resolution
144hz - Refresh Rate

Brightness:

Adjust the brightness of your screen from 1 to 100

Contrast:

Adjust the contrast of your screen from 1 to 100

ECO:

Select a pre-set picture mode ranging from:

Standard, Photo, Movie, Game, FPS, RTS, User Set

Main SR:

Adjust the sharpness of the screen, ranging from:

Weak, Median, Strong, Strongest

// OSD MENU //

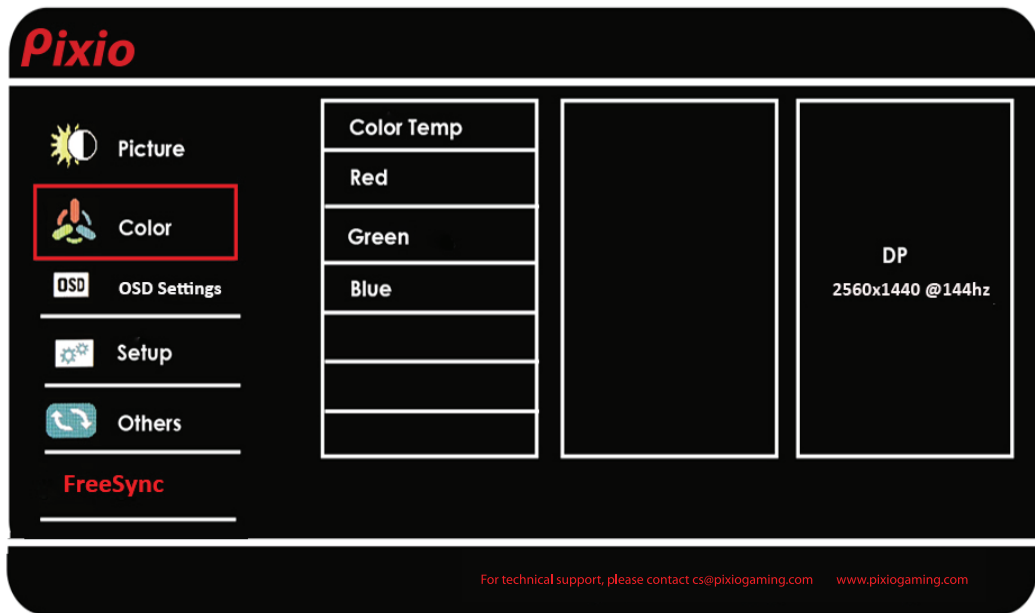

Color Temp:

Red:

Green:

Blue:

Adjust the color temperature of the screen to: 6500k, 9300k, User Set

Adjust the RGB value of Red from 1 to 100

Adjust the RGB value of Green from 1 to 100

Adjust the RGB value of Blue from 1 to 100

// OSD MENU //

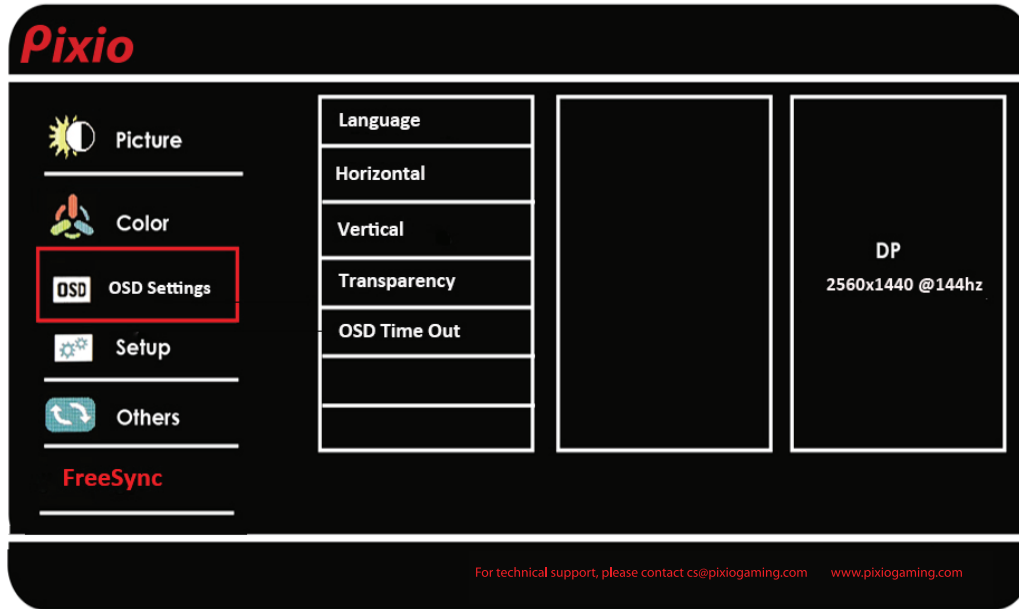

Language:

Change the OSD Menu language

Horizontal:

Change the horizontal positioning of the OSD menu from 1 to 100

Vertical:

Change the vertical positioning of the OSD menu from 1 to 100

Transparency:

Change the transparency level of the OSD menu from 1 to 4

OSD Time Out:

Change the time it takes for the OSD menu to close from 1 to 60 (seconds)

// OSD MENU //



Input:

Change the display input to: DP, HDMI1, HDMI2, DVI

Mute:

Mute the built-in speakers

Volume:

Change the volume of the built-in speakers

Reset:

Factory reset the monitor

// OSD MENU //



Display Size:
Low Blue:
Over Driver:

Change the display aspect ratio to: Full Screen, 16:9, 4:3
Turn the Low Blue Light mode On or Off
Turn the Over Driver On or Off (Response times: On = 6ms, Off = 12ms)

// ODD MENU //

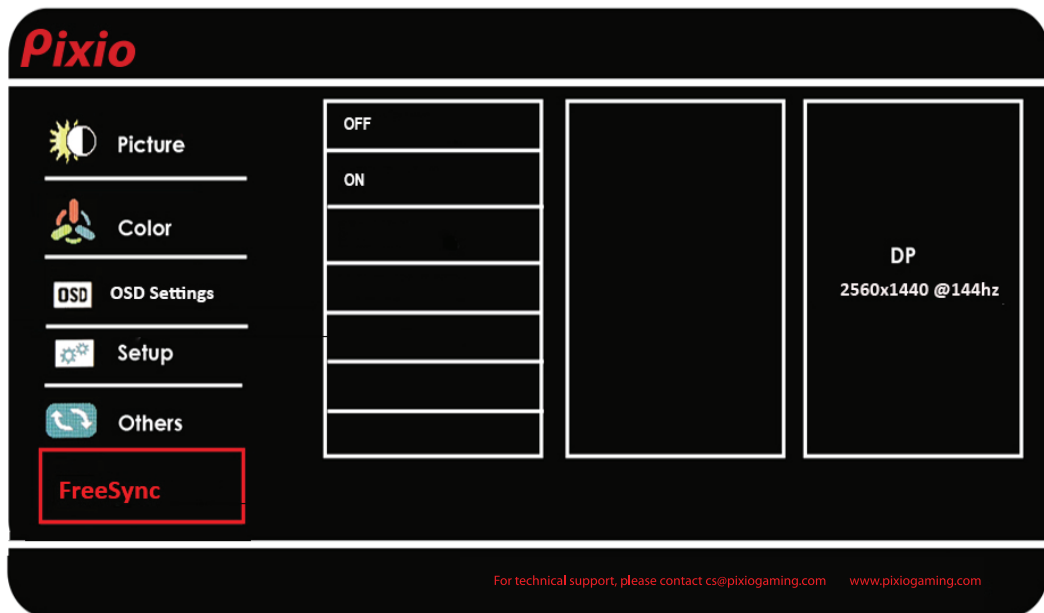

Turn On or Off

An AMD Radeon series GPU is required to use FreeSync™ functions. The monitor will run fine with an Nvidia GPU without any issues, but will not be able to take advantage of FreeSync™.

Press the DOWN key to enter the Game Menu

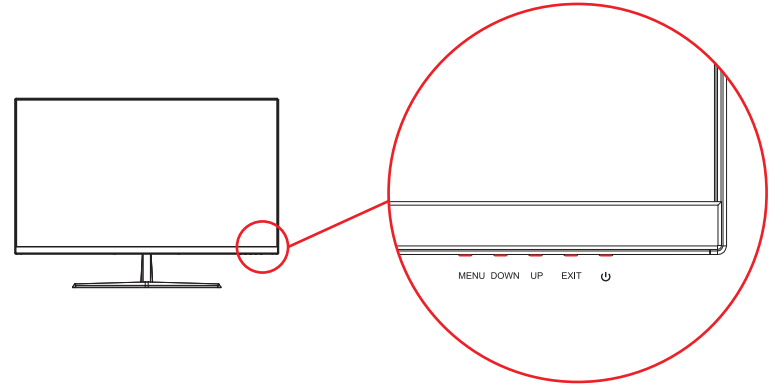
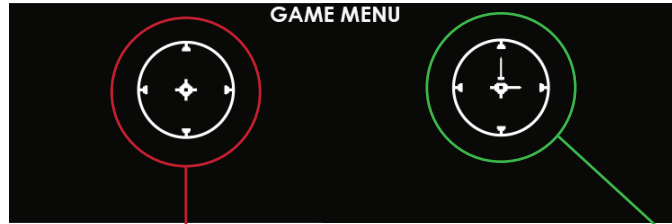

MENU DOWN UP EXIT ⏻

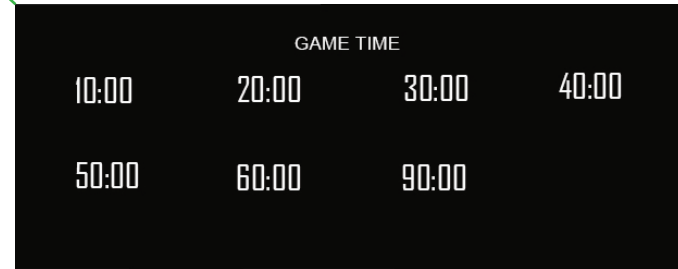
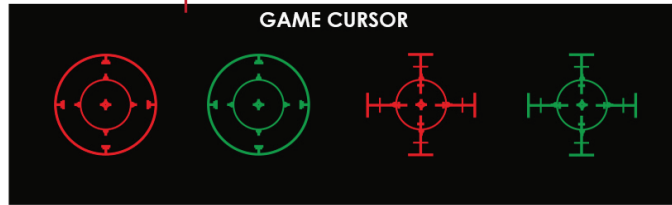

Select the left icon to enter the Game Cursor menu to select an on-screen crosshair

Select the right icon to enter the Game Time menu to select an on-screen countdown timer that starts once selected

Pixio

PX277

If you have any questions or comments,
please contact CS@pixiogaming.com

For your warranty information, please visit
www.pixiogaming.com