

A close-up, side-profile view of a black motorcycle helmet with a carbon fiber texture. The helmet features several ventilation ports and a chin bar. The text "SR-GP" is overlaid on the helmet's surface, and "USER MANUAL" is printed below it.

SR-GP

USER MANUAL

ITALIANO

ENGLISH

FRANÇAIS

ESPAÑOL

DEUTSCH

Warning

Thank you for choosing SUOMY.

Designed and manufactured in compliance with the highest qualitative standards **specifically for motorcycle use**, SR-GP is certified by the most important Certification Bodies.

Suomy cannot be held responsible for direct or indirect damages resulting from an incorrect use of the product and/or for using the helmet in situations that go beyond the normal conditions of use or the modalities indicated in this booklet.

Before using the helmet, carefully read this manual. Keep it at hand for future reference.

For further information, contact your Distributor or Suomy.

Use this helmet in compliance with the instructions contained in this manual. Compliance with these instructions will make your helmet last longer and will assure maximum product performances.

Modifications and/or alterations to the helmet and/or any of its components shall make the warranty void and may jeopardize the safety requirements or make the product non-compliant with the certification standards.

All the Suomy products are constantly subject to a continual improvement process, that's why Suomy reserves the right to make changes, without prior notice, to the product object of this manual. It is therefore not possible to exercise any rights on the basis of the information, illustrations and descriptions contained in this manual.

SR-GP was developed and tested to assure, together with the safety features, the best level of comfort and noise reduction during ordinary conditions of use. However, the particular configuration of the vehicle and/or the position of the rider or both factors can entail situations that could not be foreseen during the manufacturing of the product that may generate aerodynamic rustles or hissing sounds.

Suomy therefore, cannot be held responsible if this should occur.

SR-GP is not designed to be used with earphones and/or similar devices.

NEVER USE AGAIN A HELMET THAT HAS SUFFERED A SHOCK

A helmet that has suffered a shock must not be used anymore. Sometimes damages are not visible from the outside however the internal materials may be damaged. The helmet is designed for shock absorption by alteration and partial destruction of some parts: in case of further shock it won't be able to protect you with the maximum safety.

WARNING! Never buy a used helmet or borrow someone else's helmet. Over time the protective foam in helmets will adjust to the contours of a user's head. A used or borrowed helmet may not offer as much protection as a new helmet.

SHIELD CLEANING

The helmet shield is made of polycarbonate materials with a polyurethane abrasion resistance coating. It should be cleaned using mild soap and warm water. Never use hot water, salt water, benzene, thinner, gasoline or any other harsh agents. Additionally the use of commercial shield cleaners is not recommended because they may affect the quality of the shield material. Treat carefully when cleaning the shield to preserve the abrasion resistant coating. When deep scratches are visible, it is highly recommended that the helmet shield be replaced. Tinted shield are for "Day time use only" and are not suitable for use at night or in conditions of poor visibility.

STORE YOUR HELMET IN A SAFE PLACE

Do not keep your helmet on the rearview mirror or handlebar to avoid damages to the comfort padding.

WARNING! An improperly stored helmet can become damaged and may increase your risk of serious injury or death in an accident.

You should :

- Store helmet in a cool and dry place,
- Keep helmet away from pets and other animals,
- Keep helmet away from heat in excess of 122°F (50°C) and do not

set on or near hot surfaces,

- When helmets left out in the sun for extended periods of time, it may fade overtime.

HELMETS SOFTEN IMPORTANT SOUNDS AND REDUCE WARNINGS OF ENVIRONMENTAL CHANGES

WARNING! When using a helmet, especially of the integral variety, in a way, you are isolated from the exterior. Climatic changes may catch you off guard: sudden storms, temperature changes while entering and exiting tunnels or going through mountain passes may cause humidity or lack of visibility on your screen. Do not drive with a fogged up screen. Using a helmet reduces your ability to hear the sound of traffic, especially at high speed. When using an integral helmet, having the screen opened or closed makes a big difference. For safe driving, analyze how the level of speed and the type of helmet affect the perception of the road conditions and whether the screen has to be opened or closed.

HELMET REPLACEMENT

WARNING! Although your Suomy helmet is constructed with the best materials available to offer a long lasting product, it will eventually need to be replaced. Immediately replace your helmet if :

- It has suffered an impact. Your helmet is only designed for ONE impact. An impact may fracture the outer shell or compress the impact absorbing liner. You may not be able to detect this damage. Any impact in a crash or a drop from as low as 4 feet is enough to damage your helmet.
- The shell, lining, or retention system is damaged. The helmet shell, the impact absorbing lining, and the retention system must be in good condition to provide you with the most protection. Even if your helmet has not been damaged, it needs to be replaced every 3 to 5 years depending on how much you use it. Over time, UV rays and adhesive and component aging will damage your helmet. Wearing a damaged helmet may increase your risk of serious injury or death in an accident.

HELMET DISPOSAL

WARNING! If you buy a new helmet, destroy the old one to ensure it cannot be reused. Do not sell or give away your old helmet, even if it has not been damaged. Over time the protective foam

in the helmet will adjust to the contours of your head. If someone else uses this helmet it will not provide them with as much protection.

Features

The internal shell can be **totally removed**. It is made in excellent anallergic fabric with anti-bacteria treatment.

All the parts in contact with the face are easily **washable**.

Interchangeable side cheek pads, available in different sizes, as accessories to assure the best fit for all head sizes.

The SR-GP **ventilation** system along with the particular shape (Suomy patent) of the internal polystyrene shell, optimizes outside and inside air flows, fed by five air intakes, which exploit the Venturi effect thus optimizing internal ventilation.

The three extractors back air inlets release the air flows.

This assures a more uniform and continuous flow of air inside the shell, which is also enhanced by the extraction grid on the back part.

The strap has a **Double D-Ring** retention system in anti-corrosive stainless steel, and a button on the strap. The fastening stud is positioned in a completely free and accessible area.

The stud is easy to lock and unlock even with gloves.

When the automatic button is fastened, the strap forms an eyehole that can easily be used as «ring» to pull the tab and release the Double D-Ring fastening system.



General Rules

For maximum safety, SR-GP must fit tightly and be correctly and securely fastened, so it cannot be taken off neither by pulling it nor by rotating it around the head (see figure 1). If it is too big it may slide down over the eyes or turn in a lateral direction due to movement during riding, thus blocking visibility.

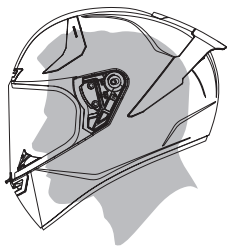

FIGURE 1

Do not use scarves or neck guards which could make the strap slide and the helmet fly off in case of crash.

SR-GP was designed to be used with most of the eyeglasses on the market. In any case check how the helmet fits with the glasses before purchasing it.

The function of the helmet is to reduce stress on the user's head in case of crash; this happens through a partial destruction and/or deformation of its components (mostly the external shell and the internal polystyrene shell). In this way part of the energy generated by the impact is absorbed by the components of the helmet, thus reducing the vibrations on the user's head, eliminating or limiting the risk of traumas. The protection capacity of the helmet is not endless and certain crashes may generate such high stress that even the energy absorbed by the helmet is not enough to protect the user from injuries: **no helmet, even top quality helmets, can protect the head against the forces generated by any type of crash.**

The integrity of the shell and of the inside are essential to assure maximum performances in terms of safety.

SR-GP was studied to absorb crashes through a partial destruction of the shell or some of its parts that could be damaged after a crash even if it is not readily visibly. If the helmet suffers further stress it might not be able to offer the maximum level of protection.

Do not use a helmet that suffered severe blows even though the damage is not readily visible; if the helmet is damaged it must be replaced. It is extremely dangerous to modify the helmet by sticking or gluing anything on it. Do not cut or punch the helmet's shell, do not insert screws or paint it.

Do not change the internal lining of the helmet, particularly never cut or change the inside polystyrene padding: changes to the shape of the internal polystyrene shell can affect the safety features of the helmet.

Damaged visors may limit visibility especially at night and must be immediately replaced with regularly certified visors according to the certification regulations in force.

Do not apply paint and/or adhesives on the visor. Do not remove homologation label from the visor.

Use

Only use original Suomy accessories and spare parts or those specifically indicated by Suomy for the specific model: this is the only way to assure reliability, safety and compatibility with the helmet used.

The use of non original components and/or accessories make the warranty void (see warranty conditions on page 35) and can affect the safety requirements.

Maintenance

To **clean the shell** use water and mild soap; let the helmet dry at room temperature, never expose it to heat.

Cleaning the helmet with solvents, petrol by-products or chemical substances, the application of stickers or paint could affect the structure of the shell, thus affecting the safety features, even if the damage is not readily visible. **Do not paint, or apply stickers, petrol or other chemical solvents to this helmet.**

To **clean the internal lining**, just hand wash at 30°C maximum, exclusively using mild soap.

To **clean the fixed internal lining** use a damp cloth and mild soap. **The fabric lining, even if they are part of removable elements, must not be soaked in water when they are applied to or paired with an internal padding, either rigid or soft.**

Dry the pieces at room temperature, away from sunlight and without exposing them to heat.

Periodically clean the «**Double D-Rings**» system with warm water and mild soap. **Do not use solvents or chemical detergents and do not lubricate.**

Clean the visor as follows:

1. Remove the visor from the helmet (see paragraph VISOR - removal)
2. Rinse it with running warm water only on the outside.
3. Wash the visor with water and mild soap using a soft cloth to remove the dirt.
4. Rinse with warm water.
5. Dry with a soft and delicate cloth
6. Put the visor back on the helmet (see paragraph VISOR - Assembly)

Verify that the cloth used does not leave any traces that could stick to the surface of the visor after washing. Do not use paper cloths to clean and dry the visor.

Do not expose the visor to heat to dry.

Do not use particular detergents (prepared solutions, creams,

etc.) even if they are classified "specific for visors", unless directly marketed by Suomy.

During cleaning operations, handle the visor with care to avoid damages to the anti-scratch coating. Never use solvents, alcohol, fuels, thinning substances or abrasive powders; these materials are aggressive and could affect the structural resistance of the polycarbonate or scratch the surface of the visor with consequent reduction in the mechanical and optical properties.

Some **colorings** are made with Fluo UV paints that could be subject to the natural migration phenomenon with a drop in intensity. The phenomenon could be enhanced when the helmet is exposed for long periods to a particularly intense light. However, this does not affect the performances and the quality of SR-GP

Suomy therefore, cannot be held responsible if this should occur.

User's instructions

RETENTION SYSTEM Double D-Ring – Figure 2

Insert the free end of the strap into the rings.

Pull until the strap fits tightly around the jaw.

After doing this, it should be impossible to slide out the helmet; verify that, by taking it from the back edge and rotating it towards the front, the helmet cannot be removed and that it remains well fixed on your head.

If the helmet tends to come off or it moves freely on the head, pull the strap tight until the right pressure is reached and repeat test.

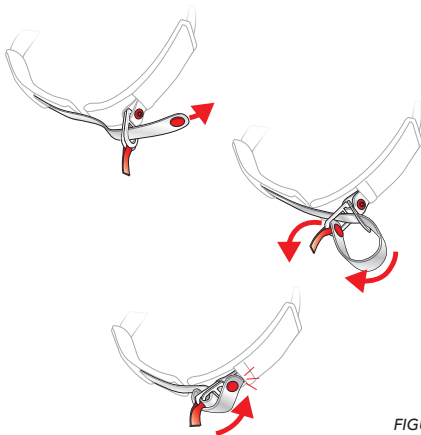

FIGURE 2

If after repeating the test you are not able to efficiently tighten the retention system, do not use the helmet.

Only after the strap has been adjusted tightly, fix the end part of the strap by fastening it with the press stud on the tongue. (figure 2).

The only function of the press stud fitted on the chin strap is to

avoid fluttering of the end part while riding. The fact the press stud is fastened is no guarantee that the helmet has been positioned and closed correctly: the correct fastening of the strap must be verified exclusively through the operations described in the previous paragraphs.

To **release** the retention system, unfasten the press stud and pull the tongue to loosen the closure. Slide out the end part of the strap from the «D Rings».

Use the unlocking tongue only to remove the helmet!

Never unlock while riding.

If the retention system does not work correctly, do not use the helmet and contact Suomy authorized personnel only.

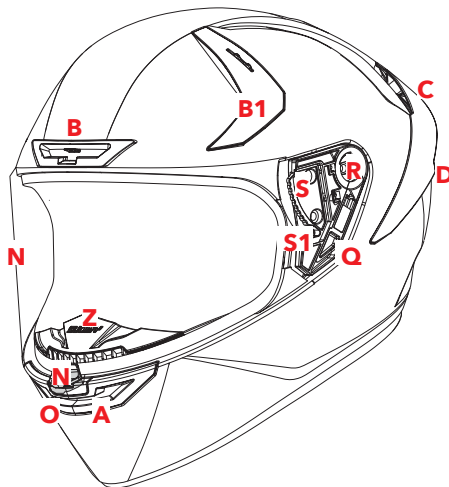

FRONT AIR INTAKE CHIN – A – Figure 3/4

The flow of incoming air in the front part of the helmet (chin) may be regulated by adjusting the slide (A1) inside the air intake:

Slide down the cursor inside the chin to open the air intake, slide up to close it.

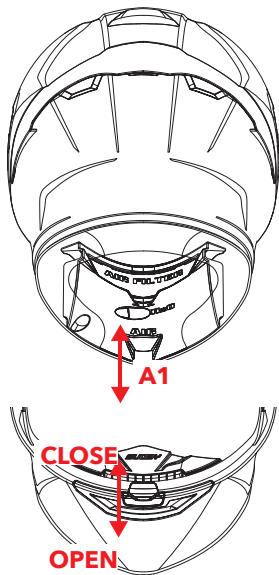

FIGURE 3

FIGURE 4

FRONT AIR INTAKE – B – Figure 5

The flow of incoming air in the front part of the helmet may be regulated by adjusting the middle part of the air intake:

- Figure 5: Slide up the central cursor to close the air intake, slide down to open it

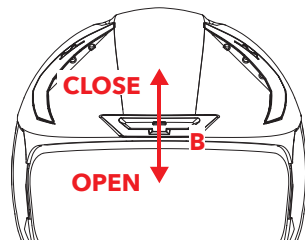

FIGURE 5

FRONT SIDE AIR INTAKE – B1 – Figure 6

The air flow that enters from the side of the helmet can be regulated by activating the cursor on the intake.

- Figure 6: move the cursor outwards to open the air intakes/Move the cursor towards the middle of the helmet to close the air intakes.

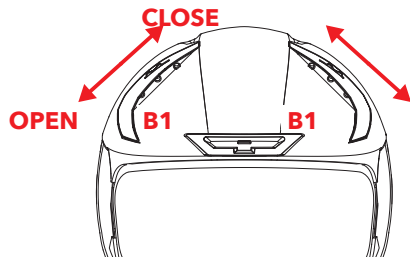

FIGURE 6

REAR AIR EXTRACTORS – C – Figure 7

The innovative rear air intake has been designed to further improve ventilation inside the helmet, using residual air flows that, again thanks to the Venturi effect, are able to generate a depression in the lower part of the helmet, in this way ensuring a substantial extraction of the hot air inside it, consequently maintaining a comfortable temperature.

SIDE AIR INTAKES – D – Figure 7

The fixed air intakes on the sides allow the extraction of air inside the helmet through the Venturi effect. Their shape has been designed to optimise this effect and therefore ensure a substantial extraction of air while maintaining perfect aerodynamic efficiency. The particular shape is also able to reduce turbulence to a minimum and limit the possibility of the helmet shaking.

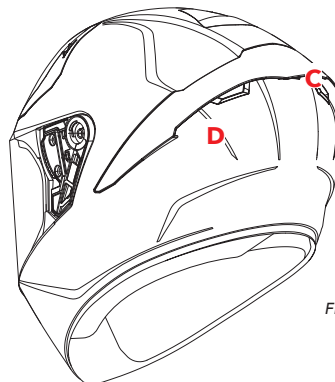

FIGURE 7

— PADDING – E – F – G –

The inner padding, can be easily removed to be washed or replaced.

Inner central padding: **INNER SHELL – E** – Figure 8

Assembly and disassembly

The inner shell (E) is fixed to the helmet through 4 press studs (F).

Removing the inner padding

Snap to open the press studs (F) and remove the inner shell (E). Be very careful when removing the shell, press on the rigid part of the stud and pull slightly towards the inside of the helmet without damaging the press stud.

Caution: to avoid damages to the inner lining, before removing the inner shell make sure that all the press studs have been unhooked.

Assembly

Insert the shell (E) inside the helmet checking the assembly direction. Fasten the press studs (F). After fixing the inner shell, make sure the shell is correctly positioned inside the helmet (polystyrene padding).

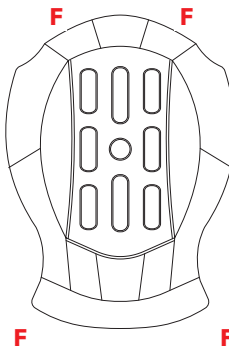
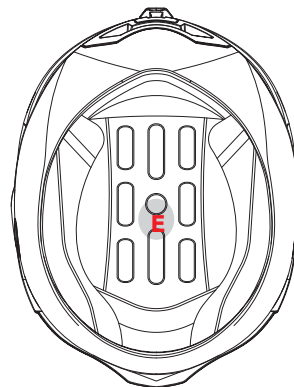

FIGURE 8

Inner side padding: **CHEEK PADS – G** – Figure 9
Assembly and disassembly

Removing the pads – Figure 10

Grab the cheek pad (G) from the front part, push it towards the back part of the helmet and then pull outwards until all the press studs are unhooked.

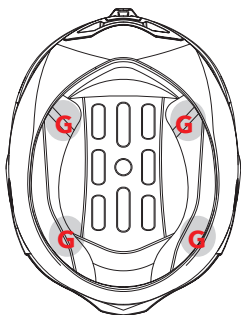

FIGURE 9

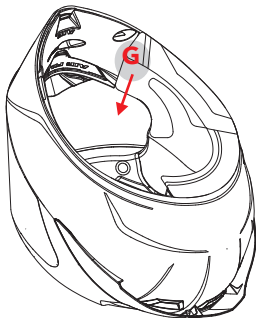

FIGURE 10

Assembly – Figure 11

Turn upside down the cheek pads from the original position.

Insert the fixing hook (H) in the red hooking hole (I)

Put the back part of the cheek pad on the fixed part of the inner lining. Verify that the fastening strap (L) is correctly inserted in the appropriate seat (M). Push the cheek pad to the back part of the helmet and hook the press studs.

Verify that the part was assembled correctly by checking that:

- the cheek pad is firmly locked in position
- the strap is completely free inside the hole and is not blocked under the cheek pad during assembly.

Only the correct assembly of the cheek pad and the correct positioning of the strap will assure the proper efficacy of the retention system. During use, the locking lever must always be fixed in lock position; if it cannot be locked correctly do not use the helmet.

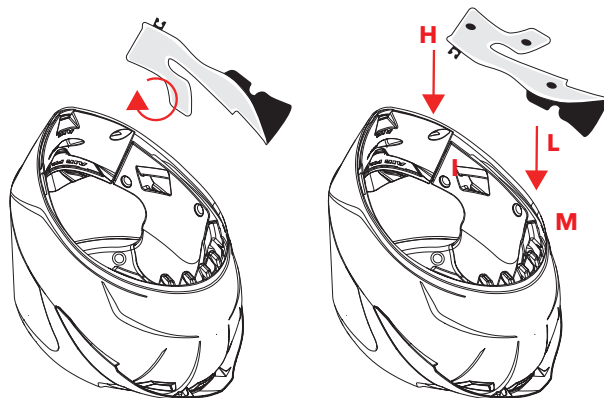

FIGURE 11

VISOR- N -

The visor must be periodically cleaned and controlled. If the visor is dirty and/or has bad scratches on the surface there could be unusual light reflections or deviations, which may jeopardize safety. Immediately replace the visor if there are these problems.

How to operate – Figure 12

The Visor has to be operated only by using the lifting lever. Do not open it using other areas to avoid causing accidental damages (scratches or lines) or dirtying the field of vision.

Opening the visor: push lightly the lifting lever outwards (O), to unlock the tab from its seat (P) under the gasket and lift it up.

Closing the visor: to lock the visor in position, lower it until the tab is blocked inside its seat (P) in the gasket. There are two locking positions: intermediate and visor completely open. The visor must be opened or closed completely up to the lock position. The visor is correctly locked into position when it clicks into its seat. To unlock the visor from the lock position just follow the above procedure, lightly press during initial phase of the movement until the visor is unlocked.

While riding the motorcycle the visor must never be left in the intermediate positions; it must always be locked in the locking positions.

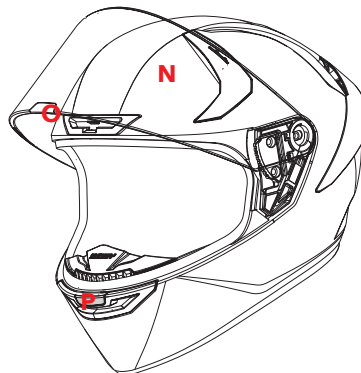
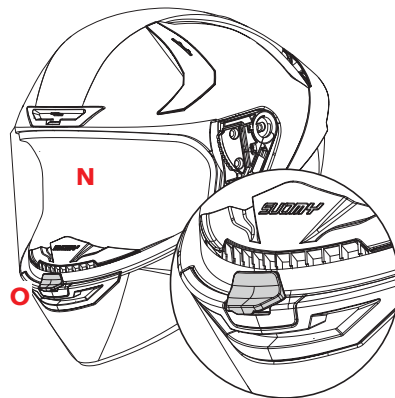
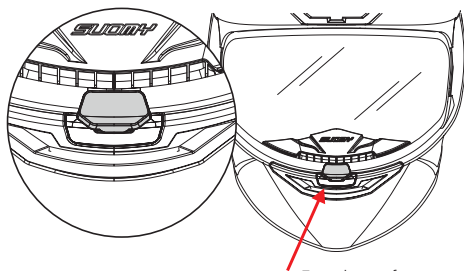
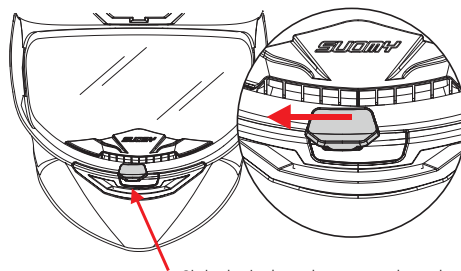

FIGURE 12

Visor closure and safety position:



First closing fit



Slide the lock on the visor to the right to insert the safety position

FIGURE 12A

To unlock the visor: Slide the lock to the left to release from safety position

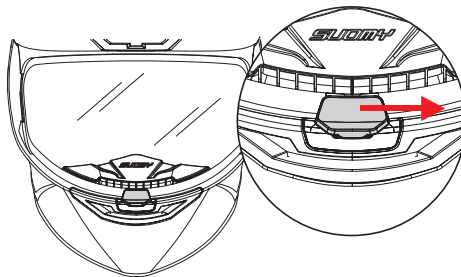
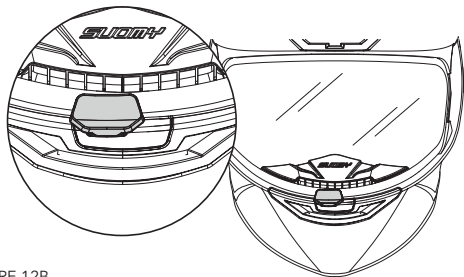

FIGURE 12B

Removing the visor – Figure 13

Open the visor until it is completely open.

Slide the lever (Q) and Keep it in tension (Q)

Remove the visor from its mechanism by rotating and at the same time by pulling it outwards.

Repeat the operation on the opposite side.

Assembly – Figure 14

To assure the proper operation of the rotation system of the visor, before fitting the visor back on, verify that all the parts (seats on helmet, visor surface in contact with the moving parts) are perfectly clean.

Open the visor completely. Position the visor on the mechanism so that the rotation seat is inserted in the rotation ring.

1) Slide the lever (Q)

2) Press slightly to stick the hooks on the visor into the slots on the rotation mechanisms

Repeat the operation on the opposite side.

After fitting the mechanism verify that the visor is tightly fixed to the helmet, that it rotates freely and that it locks correctly into the locking positions.

If this doesn't happen and the rotation mechanism of the visor doesn't work correctly, do not use the helmet and contact Suomy authorized personnel only.

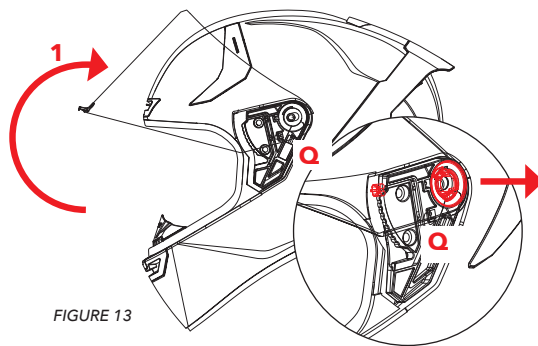

FIGURE 13

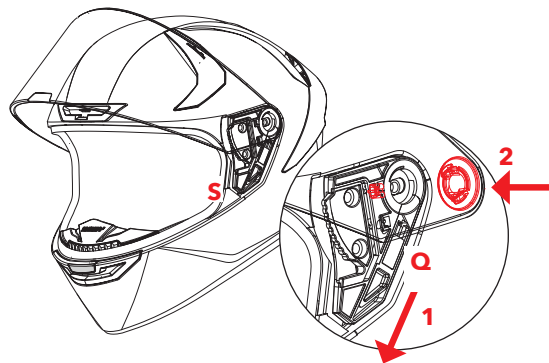

FIGURE 14

Adjustment – Figure 15

If after replacing the part, or after long use of the helmet, you experience infiltration from the closed visor, it may be necessary to adjust the mechanisms of the visor.

Lift the visor until it is completely open.

Remove the visor, as specified in the previous paragraph.

Loosen the two screw (R- S) without removing them and without disassembling the mechanism.

Shift horizontally the whole mechanism and tighten the screws.

Repeat the operations on the opposite side by shifting the mechanism on the same direction of the previous one.

Once finished, check if the visor can be easily closed and if it adheres to the gasket.

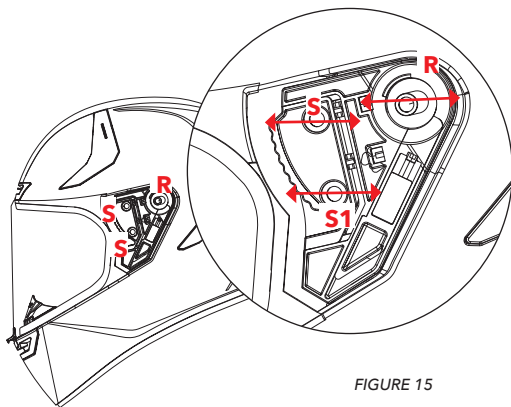

FIGURE 15

VISOR MECHANISM Replacement – Figure 16

EN

Removing the mechanism

After removing the visor as indicated in the paragraphs above, loosen and remove the screws (R- S - S1); then remove the mechanism from the shell.

Fitting the mechanism

The mechanisms are not interchangeable. Before proceeding it is necessary to identify the correct assembly side;

Put the mechanism on the shell, insert the screws tightening them.

After fitting the parts verify that the mechanisms are positioned correctly and tightly fixed to the shell. Then fit the visor and adjust it as specified in the above paragraphs.

After fitting the mechanism verify that the visor is tightly fixed to the helmet, that it rotates freely and that it locks correctly into the locking positions.

If this doesn't happen and the rotation mechanism of the visor doesn't work correctly, do not use the helmet and contact authorized Suomy personnel only.

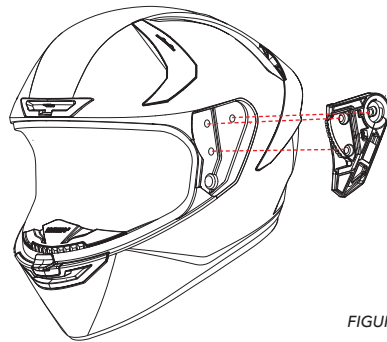
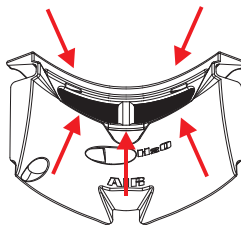
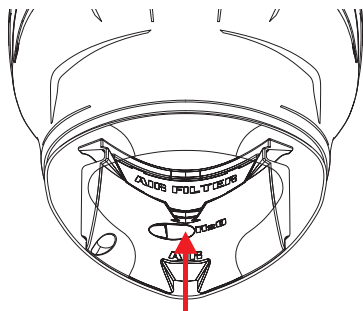

FIGURE 16

SETTING AIR FLOW - CHIN AIR INTAKE

1 Remove the cover by levering on the appropriate hole located on the chin inside the helmet.



HOOKING PLUG SEAT

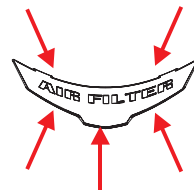

COVER HOOKS

2 remove the filter by using appropriate tweezers to increase the air flow, then refit the cover as shown in the picture.

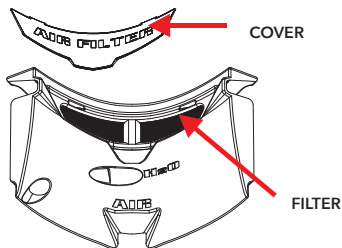

3 Refit the cover by plugging and pressing the hooking teeth in the appropriate houses and make sure that the cover is completely hooked to the chin.

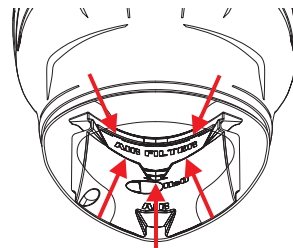

NOSE GUARD – Z – Figure 19/20

Removal – Figure 19

The nose cover is snapped into place between the cap and the inner lining of the chin guard. To remove it, all you have to do is pull it upwards.

Assembly – Figure 20

Place the nose cover in the middle of the visor's opening, inserting the tabs between the cap and the chin guard. Press with force on the nose cover where the tabs are located until the lower edge of the nose cover is fully adherent to the edge of the cap.

If this doesn't happen and the nose guard does not adhere to the edge of the shell or is not positioned correctly, do not use the helmet and contact authorized Suomy personnel only.

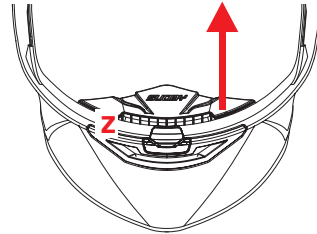

FIGURE 19

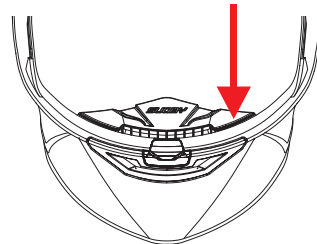
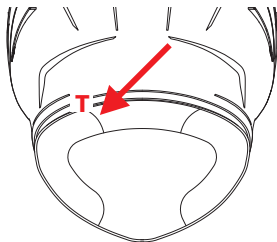

FIGURE 20

HYDRATION SYSTEM

1 Insert the pipe in the hydration system



2 Slide the pipe between the check pad and the internal part of the helmet, following the trim at the bottom.

Insert the pipe without the nozzle in its seat T on the check pads, placed in the left bottom of the helmet. Slide the pipe in its seat on the check pad following the bottom trim T1.

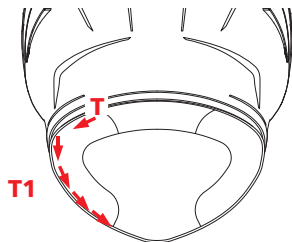

3 Insert the pipe in its house T2.

Push it until it comes out of the appropriate exit hole T3 and then insert the relative nozzle into the pipe.

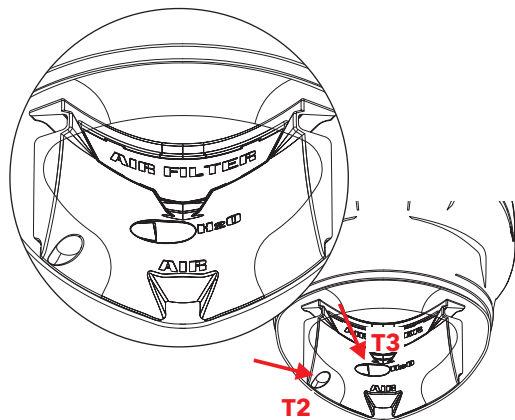

Conditions

The warranty is valid from the purchasing date of the product and must be proven by the receipt (invoice, receipt or any document that unequivocally identifies the purchasing date as for example, payment through MAC card or credit card), issued by the person selling the item.

The interventions carried out under warranty do not extend the duration of the warranty which is still of two years from the purchasing date.

The product must not have been modified and/or changed: the presence of non-original accessories and/or any, even small, changes to the product, entail the immediate cancellation of the warranty terms and the release of any responsibilities on Suomy's behalf.

The warranty is void when:

- The product has been modified, poorly painted, decorated with stickers
- Original parts have been replaced with other parts;

The Warranty does not cover damages resulting from:

- Incorrect use or non-compliant with the recommendations and requirements indicated in this manual;
- Ordinary wear of the product;
- Repairs made by the customers or third parties or by personnel not belonging to the Suomy Motosport S.r.l. Organization;
- Incorrect use of the product and/or use of the product in situations that do not comply with the purposes the product has been designed for or with the modalities indicated in this manual.

Validity

Suomy guarantees exclusively the helmet and its components for a period of two years from the purchasing date as regards conformity defects. Suomy undertakes to repair the defective product (or one of its part) or to replace it (at Suomy Motosport S.r.l.'s discretion), with no extra charge for the parts and the labor.

The warranty does not cover the alterations of the painted surfaces resulting from natural wear and tear phenomena (effect of sunlight, vapors, detergents, crashes, scratches).