

Avoid costly damage and potential injury by reading this entire manual first!

Vibiemme Domobar Super User's Guide

This guide covers all "Super" models

Created exclusively for customers of 1st-line.com



Warranty - One year parts and labor warranty limited strictly to manufacturer's defect. Warranty service provided by and at 1st-line Equipment. Repair Authorizations are required. Customer is responsible for shipping costs one way to 1st-line Equipment. It is advised to keep the packaging as repackaging can increase damages and costs in upwards of fifty dollars. Limited warranty does not include adjustments made by customer, or damage to unit caused by customer adjustments. Limited warranty does not include lost profits, abuse, damage, negligence, or any incidental, consequential, or special damages of any kind.

Parts, Cleaners, and Accessories - For additional parts, accessories, and cleaning agents not included please contact your retailer or visit www.1st-line.NET

Technical support and usage questions should be directed to your reseller/retailer.

©2007 by 1st-line.com LLC. - All rights reserved.

No part of this manual may be reproduced without the expressed written permission of 1st-line.com Specifications subject to change without notice

I. Parts Identification

This diagram represents the major features that are common to the exterior of all models. Variations between the different models are described later in this manual.

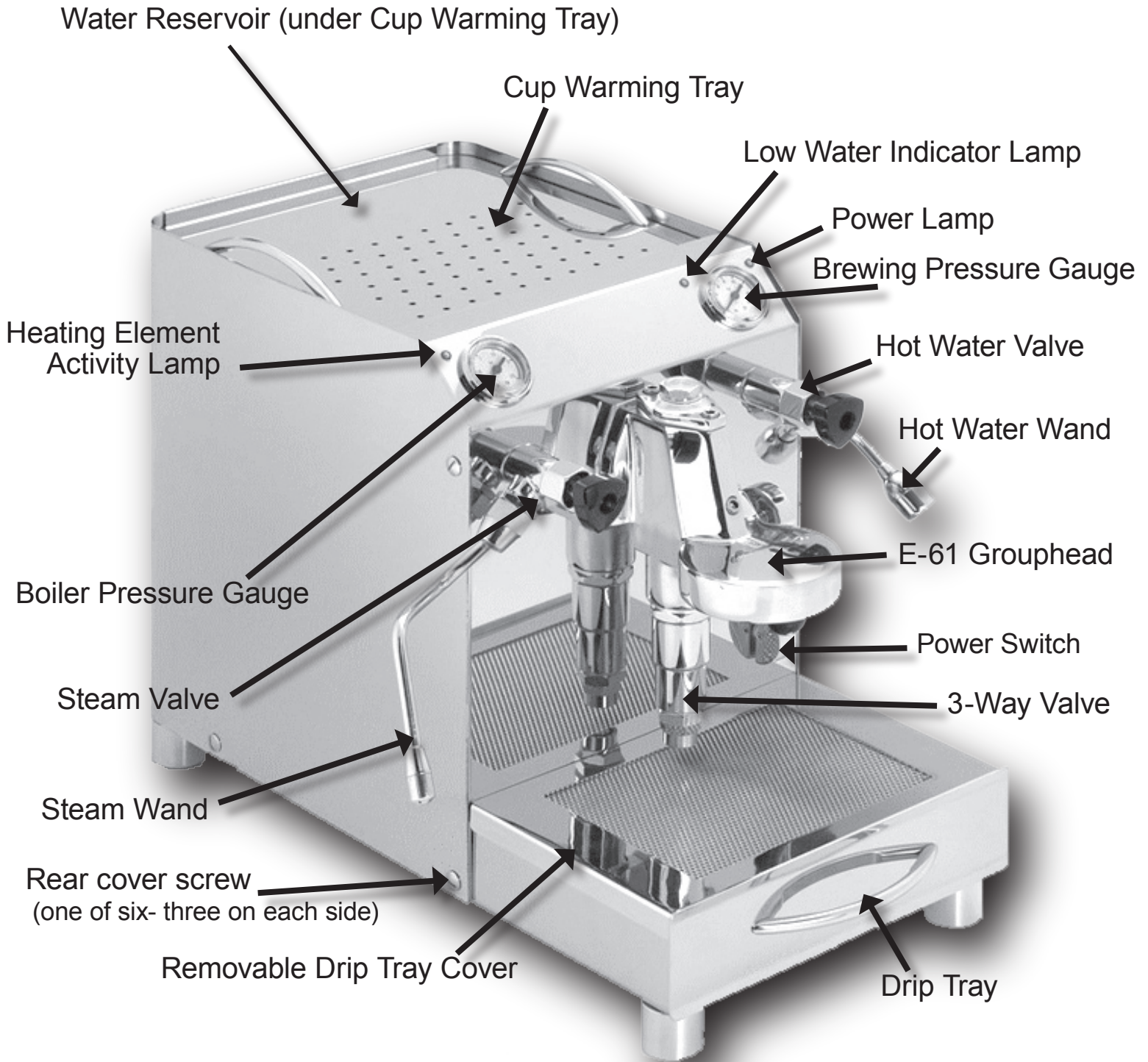

II - Quick Start Guide

To get the most out of your new Vibiemme Domobar Super espresso machine and for your own personal safety it is highly recommended that you take the time to read this manual in its entirety.

CAUTION: This quick start guide is meant for those more familiar with the operation of an espresso machine with a heat exchanger. If this is your first espresso machine, or if it is your first machine with a heat exchanger system, we recommend reading the manual thoroughly before beginning. Damage done to the machine due to improper operation is not covered by the warranty.

The numbers in parenthesis following the steps below indicate the page numbers where you will find more detailed information on these procedures:

- A • Read Safety Warnings and Cautions (1)
- B • Unpack machine and set up (10-11)
 - Remove machine from packing carton
 - Turn power switch to “Position 0”
 - Close hot water valve and steam valve (do NOT fully tighten!)
 - Remove and save packing and shipping materials
 - Install feet (do not use machine without installing the feet!)
 - Remove water reservoir and wash thoroughly and reinstall (13)
- C • Fill reservoir with proper quality water (12)
- D • Insert portafilter (14)
- E • Turn power switch to “Position I” and wait for pump to start (14)
- F • When pump stops, turn power switch to “Position II.” Stand by machine and monitor warm up (15)
- G • Grind Coffee, fill and tamp coffee in portafilter to prepare it for espresso pull (18)
- H • Pull espresso shot (4-9)
- I • Steam milk if desired (12)
- J • Clean up when done (25)



TABLE OF CONTENTS

CHAPTER	TITLE	PAGE#
I.	Parts Identification	i
II.	Quick Start Guide	ii
1	- Safety Warnings and Cautions	1
2	- Welcome and Thank You!	2
3	- How it Works	3
	Boiler Pressure Gauge	4
	A Quick Science Lesson (no homework required)	4
	Brew Pressure Gauge-	4
	Back to the Machine	4
	The Grouphead	5
4	- Operation of Each Model	7
	Manual Model	7
	Semi Automatic	8
	Electronic Automatic	9
5	- Unpacking and Assembly	10
6	- Water	12
7	- Setup and Startup-	13
	Portafilter	14
8	- It's About The Coffee	16
9	- Cooling Flush	17
10	- Grind, Dose, Tamp	18
11	- The Espresso Speedometer	20
	How Much, How Fast?	20
	TOO FAST-	20
	TOO SLOW	21
	At The Speed Limit	21
12	- Steaming Milk	22
	How To	22
	Milk Stretching Tips	24
13	- Cleaning and Maintenance	25
	After Each Pull	25
	After Each Session-	25
	Once Every One Or Two Weeks	26
	Backflushing	26
	As Necessary-	27
	Exterior Cleaning	27
	Grouphead Gasket Replacement	27
	Hot Water Wand	28
	Steam Wand	28
	Long Term Storage-	28
	Placing a Machine Back Into Service After Storage	29
14	- De-scaling	30
	How to Descale	30
15	- Hints, Tips, and Tricks	34
	Maximizing Steaming Power	34
	Minimizing Temperature Variations During the Pull	34
	Electronic Domobar	34
16	- Advanced Adjustments	35
	Brew Pressure Adjustment	35
	Pressurestat Adjustment-	36
17	- Troubleshooting	37
	The machine is not working.	37
	No water can be pumped.	37
	The grouphead is not getting very warm	37
	I can pump water, but the water is always cold.	37
	The Coffee Tastes Bad	38
	The brew pressure gauge acts erratically	38
	MAINTENANCE RECORDS:	39

1 - Safety Warnings and Cautions

- All Vibiemme Espresso machines are heavy. Take care when lifting or moving them. Place them on a suitable surface which can support their weight.
- Place power cord where it cannot be tripped over. The use of an extension cord with this machine is not recommended.
- This machine draws a lot of electrical current. Be sure that the circuit into which it is plugged can handle the draw and is protected by a GFCI (consult an electrician if in doubt). If the circuit breaker is repeatedly tripped or the circuit's fuse repeatedly blows, consult an electrician to determine the cause. A possible solution may be to use a different circuit or to be sure that the Vibiemme is the only device using that circuit.
- Power protection/surge suppression of 1040 joules or higher is recommended to protect the electronics of this machine. Even the manual model contains an electronic control for the boiler auto-fill system. Additionally, the heating element can be burned out from a power surge. Breakdowns caused by power surges are not covered by the warranty.
- There are a number of outer surfaces and components that present a serious burn hazard while this machine is in operation, and for some time even after it has been turned off. Areas like the grouphead, steam wand, and hot water are hot enough to cause second degree burns.
- All Vibiemme Domobar Super espresso machines are designed to be left on all day. This can create a safety hazard because of hot outer surfaces and easy access to hot water and steam wand valves as well as the brew switches. If there are children, elderly, pets, or others in the home to whom these may be a hazard it is important to assess the level of danger to them and act accordingly to mitigate the danger. Possibilities include placing the machine in a room or location that will not be accessible to them or to turn the machine off when not in use.
- The steam from this machine can quickly cause deep and serious burns. Use great care when steaming.
- The hot water from this machine can be at or very near the boiling point. Use caution whenever dispensing hot water.
- Some of the chemicals necessary to maintain this machine can present a safety hazard. Thoroughly read all directions, warnings, and cautions on all products before use. Be absolutely sure that the products you are using are appropriate for this machine. Misuse of a product or using the wrong product for some procedures can cause severe damage to the machine.
- Some of the procedures outlined in this manual may be beyond the ability or experience of some users. This may include, but is not limited to, opening of the case and removing and replacing wires for de-scaling of the boiler. Read all instructions before beginning any procedure, and if you do not feel comfortable performing the task refer servicing to qualified personnel. Damage caused by improper servicing is not covered by the warranty.
- When working inside the machine be aware that some of the metal panels have sharp edges. Use gloves or other appropriate protective measures to avoid lacerations and other similar injuries.
- The massive grouphead will remain quite hot for some time after turning the machine off. The thermosyphon will continue to circulate hot water through the internal parts of the grouphead for a while even with the machine unplugged.
- When shutting the machine down, aim the steam wand and the hot water wand over the drip tray so if the machine is turned on with a valve open the steam or hot water will be less likely to cause burns to anyone nearby.
- Never immerse the machine in any liquid, and do not allow liquids or other foreign matter to drip or pour through the top of the machine.
- If a puddle of water appears under the machine, immediately unplug it from the outlet, and turn the power switch on the machine to "0" (off). Check to see if the drip tray is overfilled. If not, contact your reseller/retailer for diagnosis and technical support.



2 - Welcome and Thank You!

Congratulations on your choice of a Vibiemme Domobar Super espresso machine (in Italian the name is pronounced “Vee•Be•Em-may Dough•Mow•Bar”). Regardless of which model you purchased, we regard these machines as the top of the line in home espresso machines and we think you will as well. We want you to be successful in your espresso making endeavors, and to that end we have provided this guide to help you get started. Although this guide was created with the new barista*¹ in mind, it also contains lots of useful information about your new Domobar Super for those experienced in the art of espresso.

We highly recommend reading this manual in its entirety before using your Vibiemme Domobar Super espresso machine! Keep this manual handy and refer to it often.

Patience is, indeed, a virtue, and it is so with making espresso. The machine you have just purchased will last many years with proper care, and your skills will improve over time as well. Don't expect the very first espresso you create to be perfect, and if your early efforts are delicious, don't be surprised if you make a few drinks some-time later that are not up to that standard. This guide is designed to help you make as many of the former and as few of the later as possible. It is written to give you an understanding of the machine, the process, and how to diagnose and overcome some of the more common problems associated with creating espresso. To help you enjoy your machine as long as possible we have also included a chapter on maintenance.

The process of getting an espresso machine and its grinder and all the variables involved in making espresso aligned is called “dialing it in.” Just because you bought a good cut of beef and have a nice stove, it does not mean that you are about to cook a great steak. Just because you have one of the finest home espresso machines available does not guarantee that the espresso is going to be great every time. It takes attention to detail and the right ingredients, combined with some skill and finesse to make great espresso. It is a difficult skill to master.

As you begin learning how to make fine coffee beverages, the best advice we can give is that your early efforts should be aimed at consistency. Mastery of the machine as well as the process comes from repetition. The best skill to hone as you begin is the ability to do all the various steps the same way each time. When that happens, small changes can be made in experiments to improve the flavor of the espresso. That is the difference between being a person who makes espresso and becoming a barista, or, if you will, between a cook and a chef! We want to help you go from a person who makes coffee to a person who creates fine espresso.

Follow this guide and practice, practice, practice, and soon you will have all your friends, family and neighbors clamoring for you to throw yet another espresso party!



*1 In Italian, a barista means bar keeper, but here the term is more often used to identify a person experienced in making espresso.

3 - How it Works

We feel that before you begin using your new Vibiemme Domobar Super espresso machine that it would be a good idea to give you a basic understanding on its inner workings. This knowledge will give you a better understanding of the rest of this guide.

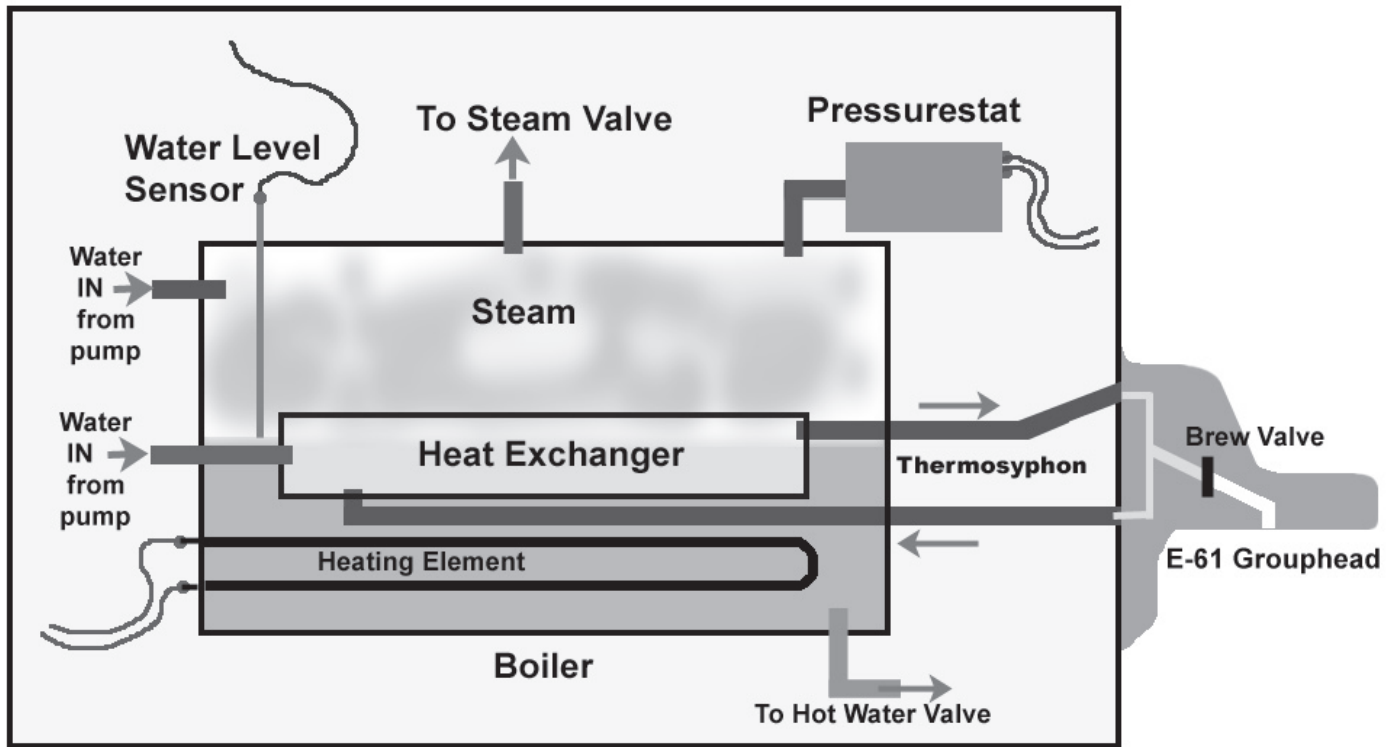

NOTE: This is a diagrammatic representation of the major components of your Domobar Super. It does not accurately represent the physical layout or actual locations of the various parts of a Domobar Super. It is designed to only illustrate the workings of the machine.

The large rectangle represents the case of the Domobar Super. It houses all the working elements of the machine as shown above. The E-61 grouphead, as shown, is on the outside of the case.

When you turn the power switch to Position I, the electronics check to see if the boiler is filled to the proper level. The water level sensor is a special wire that is passed through the outside of the boiler. It sends a small electrical current through the water to the boiler's inside surface. If the sensing wire is not touching the water it cannot send the electricity through the water. An electrical wire is connected to the end of the sensor to the control unit. If the water level is too low the control circuit turns the pump on and at the same time a valve opens to direct the water into the boiler. How far this sensor is pushed into the boiler determines the level of water in the boiler. Pushing it in further maintains a lower water level. Pulling it out creates a higher water level in the boiler. Among other things, the water level determines the amount of steam stored in the boiler and insures that there is enough water to cover the heating element as well as immersing the Heat Exchanger.

Inside the case the boiler is the largest single component. In normal operation the boiler will be about one-half to two-thirds filled with water. Immersed near the bottom of the boiler is the heating element. When you turn the power switch to Position II, the heating element is energized and the water begins to heat, some of the water turns to steam, and the pressure inside this closed vessel begins to increase.

To control the temperature of that water there is a device called a pressurestat- a pressure-controlled switch. When the pressure in the boiler reaches a certain level the pressurestat turns off the element. This cycling can be seen through the activity of the Heating Element Indicator Lamp on the front panel.

But why sense pressure in the boiler when it is temperature in which we are interested? Pressure is an indirect measurement, but one that is easy to control and yet accurate without using more complicated electronics. Heated water at a given pressure is always at a predictable temperature. That is indicated by the left-hand gauge on the front panel of the Domobar Super. As the temperature changes in the boiler you will see the pressure gauge rise and fall.

Boiler Pressure Gauge

The boiler pressure gauge on the front of the machine is calibrated in “BAR.” That is barometric pressure. The boiler works like a pressure cooker in that as the pressure in the boiler increases the boiling point of water in the boiler increases:

Boiler BAR	Boiler temp	Approximate brew temp
1.0 - - - -	253 F. (123 C.) - - - -	196 F. (91 C.)
1.1 - - - -	255 F. (124 C.) - - - -	199 F. (93 C.)
1.2 - - - -	257 F. (125 C.) - - - -	201 F. (94 C.)
1.3 - - - -	259 F. (126 C.) - - - -	203 F. (95 C.)

A Quick Science Lesson (no homework required)

Gauge readings can be confusing. Let us try to make a bit more sense of it. The boiler pressure gauge is reading the pressure above the outside pressure, so a reading of 1 BAR is actually a pressure of 2 BAR in the boiler. The laws of physics teaches us that at a constant volume (in this case we are speaking of the enclosed boiler in our Vibiemme Domobar), as the pressure of a gas increases or decreases, by the same factor does its temperature increase or decrease. In plain English, as the pressure in the boiler rises so does the temperature in the boiler.

Just like in a pressure cooker, the rising pressure of the steam in the boiler allows us to actually raise the temperature of the water without having it boil. This temperature which is above the boiling point of water also allows some temperature drop between the boiler and the grouphead so that when the water reaches the coffee it is at the correct brew temperature.

Brew Pressure Gauge

The information that this gauge displays can actually be confusing. This is because it is reading the pressure inside of the Heat Exchanger. When the machine is at idle (or actually at any time other than when brewing espresso) the readings of this gauge should be ignored. Its only function is to report brew force and at any other time the reading is not reporting anything of note at all.

During the brew cycle the reading should be in the range of about 9 to 9.5 bar if everything else is correct. That statement is only accurate if all other factors are right. More on that later in this manual.

Back to the Machine

The temperature for brewing espresso is in the area of 200 F. So why are the boiler temperatures so much higher? There is heat energy lost between the boiler and the heat exchanger, and again through the copper thermosyphon pipes as the water is pumped out of the heat exchanger, and again in the grouphead. The idea is to have the correct temperature at the coffee, so to compensate for the loss of thermal energy the designers compensate with a higher boiler temperature.

The Heat Exchanger is partially immersed in the boiler water. The HX is a tube through which the brewing water passes. This water gets heated through an exchange of heat energy from the water and steam in the boiler to the metal of the heat exchanger, and then from the metal parts to the water in the HX tube itself- thus its name, because heat energy is exchanged from the boiler water to the brew water.

When you need steam you open the steam valve and steam is drawn off the top of the boiler. This will cause a drop in pressure in the boiler which will again trigger the pressurestat to turn on the heating element to help maintain the boiler's temperature. You may also hear the pump occasionally cycle if the boiler's water level goes below the sensing wire..

WARNING: The steam comes out with a lot of force and can cause serious burns. Use great care when using the steam function.

When you need hot water, you open the hot water valve and the pressure of the steam as well as the pump pushing water into the boiler force hot water through the wand. The machine automatically routes the water to the boiler or to the heat exchanger depending on what mode the machine is in at the time. Limit the dispensing of hot water to no more than about six ounces at a time. After drawing water allow the pump to refill the boiler and the boiler to come back up to temperature before further use.

WARNING: The water which is being dispensed can be very near the boiling point, please use great care when dispensing hot water.

The E-61 grouphead, originally designed by Faema in 1961 (reportedly a year that had an Eclipse, thus creating the components of the name "E" and "61") has a thermosyphon design. The Thermosyphon is a water path from the HX, through the grouphead, and back to the HX. The upper connection channels hot water into the grouphead (hot water rises) where it transfers heat energy to the massive amount of metal there. The water cools just a little as it leaves its heat energy in the metal. This water becomes 'heavier' as it cools, and the cooler water "sinks" back into the heat exchanger. This convection current continues to heat the grouphead while the machine is on (and even for a time after it is turned off). This helps create a consistent brew temperature throughout the brewing path- a critical component for quality espresso.

All this sounds quite complex just to make coffee, but one of the benefits is that you can go from brewing to steaming and back to brewing nearly as fast as you can work- indeed, you can actually steam and pull shots at the same time if you need to! Anyone who has used a "single boiler" espresso machine and has had to wait for

steam to build up before stretching milk, and then had to refill the boiler and wait for the temperature to drop to allow another shot to be pulled will immediately realize the benefits of the HX design. Hot water is always ready to make espresso and steam is always ready to stretch milk.

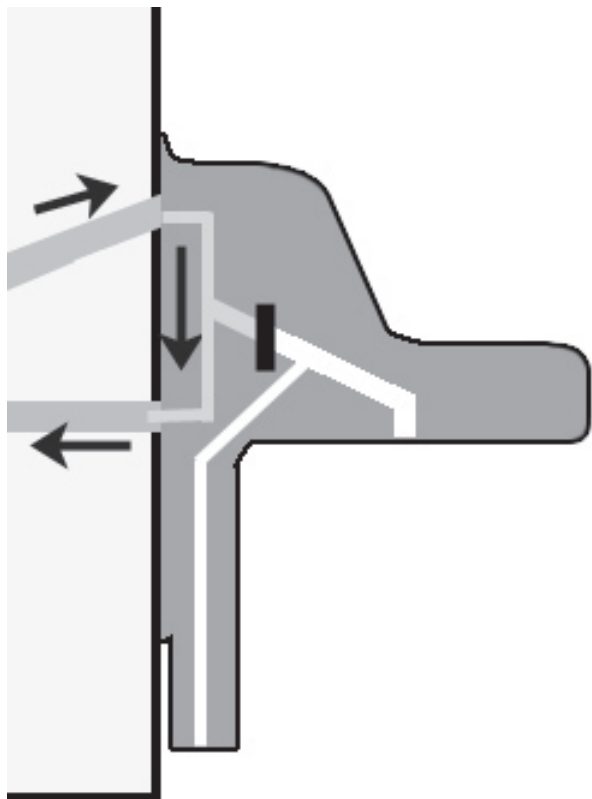

The Grouphead

Let's take a look at the grouphead in actual operation:

NOTE: Much like the above diagram, the following images do not accurately represent the layout of the internal working of the E-61 grouphead which is quite a bit more complicated than shown here. These simplified diagrams were created to only represent how an E-61 grouphead functions.

When at rest (as in this first image) the water circulates from the heat exchanger, through the grouphead, and then back through the heat exchanger. This flow is indicated by the arrows. This is a passive system, powered through convection. Note that the brew valve is closed, and the coffee is isolated from the water flow at this time.

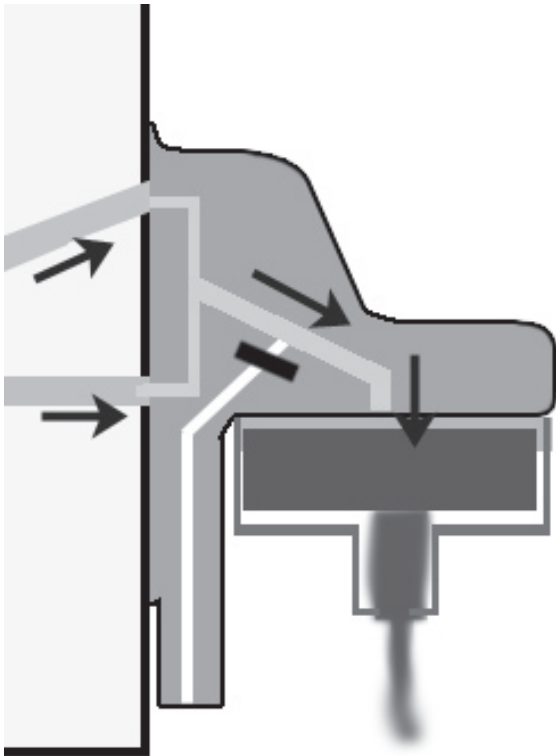

Brewing

When in brewing mode the valve opens and the pump is activated. Hot water, under the force of pressure created by the pump, forces water through the coffee which comes out as espresso. The only path the water can take is through the coffee.

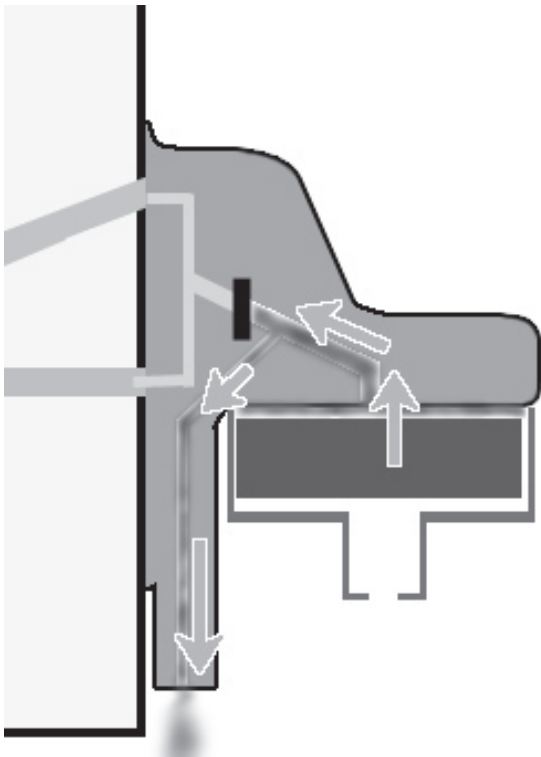

3-Way Valve Operation

When the brewing process is stopped, the valve is returned to its off position. There is still some water, under pressure, trapped above the coffee. When the brew path was closed to stop the flow of water from the heat exchanger to the coffee, it opened a path from the coffee, through the grouphead, and through the 3-way valve which leads to the drip tray. A “woosh” of pressure is relieved sending the excess water and coffee into the drip tray. This relieves all pressure on the brewing area so that the portafilter can be immediately removed without fear of being sprayed by hot water or coffee grounds.



4 - Operation of Each Model

The three models of the Vibiemme Domobar Super espresso machines contain the same basic components. They also share a few external similarities. This chapter covers the controls and basic operation of all three models. Let's begin with the components common to all models which are on the front panel:

On the far left side of the panel is the boiler pressure gauge. This displays the pressure in the boiler which indirectly supplies you with the water temperature in the boiler. The higher the pressure, the higher the temperature. While the machine is idling this gauge will move upwards when the heating element is on, and will slowly move downwards when the heating element is off. Generally speaking, a reading of about .9 to 1.1 should be expected. The gauge will fluctuate in a range of about .15 in normal operation when the machine is idling (on, but not being used). Each division is .05 BAR (.73 psi).



The indicator lamp to the left of the boiler pressure gauge indicates heating element activity. When the heating element is energized the lamp will be illuminated as seen here.

The gauge on the right side of the display panel displays the pressure in the brewing path during an espresso pull. This gives a general indication as to what is happening during the brewing cycle. The only time when the gauge will display any useful information is when the brewing process is underway. At all other times, even when the pump is refilling the boiler, this gauge is not displaying any useful information and should be ignored. About 9 BAR is a good place to be brewing as you get started. Each division is .5 BAR.



To the left of the brew pressure gauge is the water level indicator lamp. If this is illuminated it means that the water reservoir needs to be refilled and the machine will not operate until this task has been completed. In this photo the lamp is off indicating that the reservoir has sufficient water to operate.

To the right of the brew pressure gauge is the power indicator. This lamp is illuminated (as seen here) when the machine is plugged into an electrical outlet and the machine is switched to either the I or the II position. The indicator lamps make it easy to judge the machine's state at a glance.

The three models differ in how the brew function is operated and the design and function of the related user interface. How each works is explained below:

Manual Model

The manual model is the most traditional representation of the E-61 grouphead in the Domobar line, and its operation is quite simple. This machine is manual in its function with only one switch controlled by a lever on the grouphead itself.

Here you see the manual control lever on the right side of the E-61 grouphead. It is shown in its at-rest position. This is where the lever should be whenever the machine is not brewing espresso.





When the lever is lifted just past the first click stop the passive pre-infusion begins. This allows a slight flow of water onto the coffee. This gentle flow of water wets the puck slightly which helps with extraction and can also help eliminate channeling (disruption of the coffee causing a fast flow). It is not necessary to use this position, but leaving it in this mode for about two or three seconds can be useful.

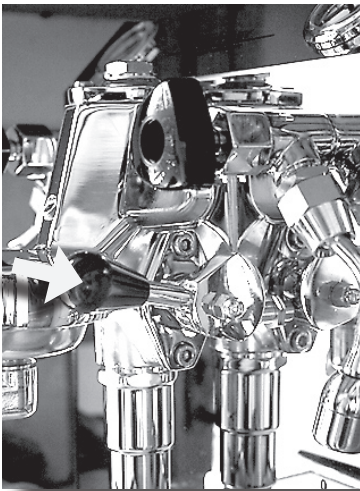

Lifting the lever to its full up position (shown in the photo to the left) closes the 3-way valve and opens the brewing path between the heat exchanger and the coffee.

At the same time, the cam to which the lever is attached depresses the switch on the front of the Domobar Super, just to the right of the E-61 grouphead, behind the cam. This switch activates the pump.

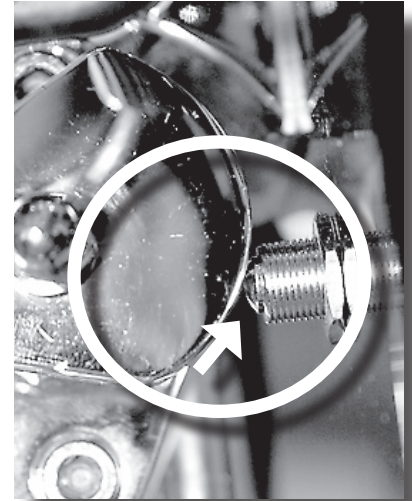

When you choose to end the brewing cycle, return the lever to its at-rest, fully down position. Moving the lever to this position turns off the pump and opens the manual 3-way valve which is built into the grouphead. This is a path from the grouphead down through the lower portion of the casting, and into the drip tray. When it is opened it allows the pressure remaining in the brewing path to flow into the drip tray. This allows you to immediately remove the portafilter without worrying about the “portafilter sneeze”- that’s a spitting out of coffee or hot water from confined pressure as can happen on lesser machines without a 3-way valve.

Semi Automatic

The semi-auto model is identified by its single button in the center of the control panel, between the gauges. Pressing this button turns the pump on and energizes the electrical solenoid, closing the 3-way valve. The brewing path is now sealed and the full force of the pump, as regulated by the pressure relief valve (OPV), can be delivered to the coffee.

When you choose to end the brewing cycle, press the brewing button once again. The pump will be turned off and the 3-way valve’s solenoid is de-energized. The valve opens and relieves the pressure remaining in the brewing path and releases it into the drip tray. This allows you to immediately remove the portafilter without worrying about the “portafilter sneeze”- that’s a spitting out of coffee or hot water from confined pressure as can happen on lesser machines without a 3-way valve.



Electronic Automatic

The electronic version features an advanced system to control the brewing cycle. This model can be identified by the five buttons across the front panel. The first four buttons choose the brew volume. The first pair of buttons are for single shots (a short-single and a normal single volume) and the next two choose the volume for double shots (a short double and a regular double), but you can use them any way you like as described below.

The button furthest to the right (the fifth one in line) has multiple functions. First, you can use it to start and stop the brewing process just like the semi-automatic described above. Momentarily press and then release the button and the brew cycle begins. When you want to stop the brew cycle press and release the button again. As a novice barista with the Vibiemme Domobar Super, this is the best mode to use until you become more comfortable with the machine and the process.

As you progress and your espresso becomes a bit more consistent from day to day, you will be ready to set and use the programmable buttons. The following process works the same way for each of the four buttons. Let's follow the procedure on how to program one button, and then you can repeat the process as needed for the other three buttons:



1 - Prepare for a pull as usual- grind, dose, tamp, and lock the portafilter in place (covered in detail later in this manual).

2 - Depress and hold down the "Manual" button (indicated here) until the green signal lamp directly above the button begins to blink, then release the button. Before the blinking stops, depress one of the four programmable buttons that you wish to program. The brew cycle begins as soon as you press the button.

3 - When the amount of time you choose has elapsed, press the same programmable button again to stop the brew. That's it! That button is now programmed, matching the amount of time of the pull you just concluded. After you stop the brew cycle during this programming mode, it takes about twenty seconds for the electronics to "remember" the programming just completed. During that time do not use the machine or the programming just completed will be lost.

You can now repeat the programming process for the other three buttons if you choose.

Use of the programmed buttons couldn't be easier! Get ready to make espresso as usual, then just place a cup under the spouts and press the programmed button of your choice. The pull begins and ends with no further attention needed. When using a programmed button the pull can be stopped at any time by pressing the manual (fifth) button.

It is important to note that the buttons are set by time of brewing and not volume of water. Your programming will not produce the same results if factors affecting brewing change such as changing the coffee you use, the age of the coffee, roast level, changes in grind, or changing the brew temperature or brewing pressure occur.

Regardless of how you begin the brew cycle, when the brew cycle began, the 3-way valve's solenoid was energized and it closed the valve, sealing the brew chamber. When the brew cycle ends the pump will be turned off and the 3-way valve's solenoid is de-energized and the valve opens and relieves the pressure remaining in the brewing path, and releases it into the drip tray. This allows you to immediately remove the portafilter without worrying about the "portafilter sneeze"- that's a spitting out of coffee or hot water from confined pressure as can happen on lesser machines without a 3-way valve.



5 - Unpacking and Assembly

CAUTION: The Vibiemme Domobar Super espresso machines are quite heavy. The shipping weight is around 70 pounds! We recommend getting assistance whenever the machine has to be moved or relocated.



The Vibiemme Domobar comes double-packed to protect it during shipping. Remove the inner box from the outer, and then open the inner box and carefully remove the machine. Standing the box up on a carpeted surface or on a large, soft towel so that the machine has its backside down makes it easier to slide it out of the box (as shown here, to the left).

CAUTION: The machine ships with the hot water valve closed and the steam valve open **DO NOT** force the valves. Moderate pressure is sufficient to open or close the valves. They do not have to be shut tight, or “seated” like a home faucet to seal properly.

Slip off the large plastic bag and remove the end of the power cord from the parts box. Slide the parts box sideways to remove it from its shipping location.

Please inspect the machine upon unpacking to be sure it was not damaged during shipping. Report any shipping damage immediately to the shipper as well as to your reseller/retailer.

WARNING: There are times when a machine will dribble water during shipping. If you notice that the machine arrives wet or dripping, remove the machine as described in this section, but wait 24 hours to allow excess moisture to evaporate to alleviate any electrical danger or damage from short circuits. If in doubt, open the case as described later in this manual to assist in the drying as well as to inspect for accumulated water in the machine.

You may notice that there is a rough area on the right side of the grouphead where the chrome is not quite as smooth and shiny as the rest of the grouphead. This is from the production process and is not a defect.

Assembly is quite easy. Open the small box which was packed under the grouphead. In that box you will find a small bag with four, round, chrome-steel feet. These screw into the bottom corners of the machine. These are easier to install with the machine still on its back. If necessary, tip the machine slightly to get the screw threads started for the two bottom feet.

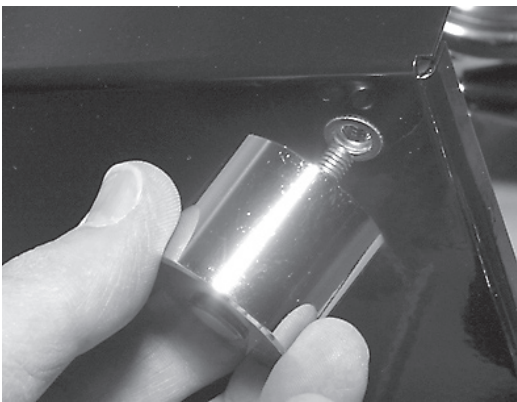

CAUTION: The feet must be installed. Do not use the machine without them. The air space under the machine is important for proper operation and the life of the machine.

After the feet have been installed, stand the machine upright and remove the five pieces of tape- three holding the top cup warmer and two holding the drip tray cover.

Remove the cup warming tray and take off the protective plastic wrap and the white, stick-on protective plastic on the tray itself. Clean any remaining adhesive or bits of plastic from the warming tray with a cleaning product meant for stainless steel.

Inspect the area of the inner panel under the cup warming tray. There should be a small black plug inserted in the panel. If not, it is possible that it fell into the machine during shipping. If the plug is not visible, remove the six slotted screws (three on each side of the back panel) and slide the panel off to the rear of the machine. It can help if you spread the front of the panel just enough get it to slide easily. Replace the back panel when the plug has been retrieved.

To replace the cup warmer tray, hold it at a sloping angle with the front edge lower than the rear. Lower the front edge in place, then lower the back edge until it hooks the back edge of the machine.

Return the shipping materials, packing, plastic bags, padding, and boxes to their original locations save them in case the machine needs to be shipped in the future. The machine must be repacked in a double box for shipping to avoid damage.

CAUTION: Do not plug the machine in at this time!

The drip tray cover has a front and a rear side. The rear side (the edge facing away from you that sits up against the front of the face of the machine) has a cutout in the corner as shown here.

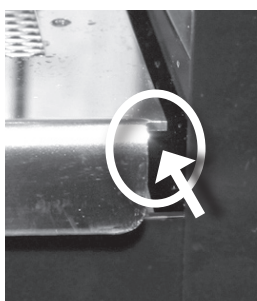

Where you place your machine is important. The size and weight of the Domobar Super espresso machine is such that having it in a location where it will not need to be moved is highly recommended. One of the first considerations is placing the machine where you will have access to the water reservoir. Locating the machine under an overhead cabinet will make access to the water reservoir nearly impossible. Having the machine somewhere near a sink for easy disposal of the contents of the drip tray as well as washing various parts after use is a good idea, but don't place it so close that washing dishes and other such chores will cause splattering on the machine which could leave difficult-to-remove stains. You should also allow room to have the grinder close by the espresso machine. Logically, there needs to be an electrical outlet that can handle the load from the machines. If you have any doubts, or if the circuit breaker trips when using the machine you should use another circuit. If you have any doubts, please consult an electrician for professional advice. The circuit needs to be protected by a GFCI and have surge suppression of 1040 joules or higher.

Upon careful inspection you may find some water stains or wet spots on your new Vibiemme Domobar Super that make the machine appear used. These spots are from testing at the factory to be sure that the machine is operating properly before shipping.

NOTE: Be aware that once the machine is in place it will be quite difficult to move on the counter because of the non-skid feet. Carefully chose a location for the machine.



The other items in the box are as follows:

- 1 - a double portafilter with double basket
- 2 - a single portafilter with single basket
- 3 - a blind filter basket for cleaning chores
- 4 - a grouphead brush for cleaning the shower screen and grouphead gasket
- 5 - a coffee measure

Also included is a plastic tamper (not shown). It is best to just place the tamper back into the small packing box as it should not be used. We highly recommend a proper-sized tamper for best results. All Vibiemme Domobar Super espresso machines use a commercial-sized 58mm filter basket.

6 - Water

All coffee beverages start with two things- coffee and water. Because the majority of espresso is water, it should come as no surprise that quality water is important to the taste of the espresso. Additionally, using the wrong water can eventually cause problems for your machine and even cause part failures. So what water to use?

None of the Domobar Super espresso machines can use distilled or reverse osmosis (RO) water because these waters contain virtually no minerals. The water level sensor in the boiler needs a small amount of minerals to sense the water level. Without these minerals the boiler will be overfilled and that can cause numerous problems, and can even damage the machine. On the other hand, water too high in mineral content or water containing the wrong minerals can cause rapid buildup of lime and calcium deposits that can reduce boiler volume, cause poor heating performance, and can eventually lead to heating element failure.

Water hardness test strips are available that can be used to make sure that the water you are using is safe for your machine. Inexpensive TDS meters are also readily available for purchase and these can be used to test the hardness of your water. If you find that your water is too hard, we recommend using either an in-tank replaceable water softener cartridge that attaches to the inlet hose or a Brita filter system- or both! The Brita pitcher-style filters are made to improve the taste of the water as well as soften the water by removing calcium and lime which are generally the worst offenders when it comes to causing hard water deposits in the boiler.

If you don't want to deal with filtering water in the pitchers then another solution is to install an in-line, under-the-sink water filter designed to filter water to be used in espresso machines. Check with your retailer/reseller for more details on which of these filter systems would work best for you.



7 - Setup and Startup

Before turning the machine on, the first thing to do is to remove the water reservoir. To access the reservoir, lift the top off the machine using the two handles and place the cover aside. The water reservoir, located in the rear of the machine, has two hoses inserted into it. Pull them out of the tank and lift the reservoir out of the machine. Use a small amount of mild detergent and warm water to wash the reservoir, and rinse thoroughly to remove all traces of soap. Never use any abrasive scrubbing pads or brushes on the reservoir. These will leave scratches in the plastic which may eventually harbor microorganisms. The water reservoir should be washed in this way every two weeks or so. This helps prevent the growth of any undesirable organisms in the water.



Look down into the area where the water reservoir is placed. In the bottom of the area is a removable platform that lifts out. Be sure it is properly seated. The springs at

each corner and the screw protruding in the center all point downwards, and the cut corners face to the rear of the machine. Be sure that the platform is properly seated with the protruding screw in the hole that activates the microswitch. Replace the water reservoir in the machine. Be sure that both hoses enter the reservoir correctly and are not kinked or pinched.

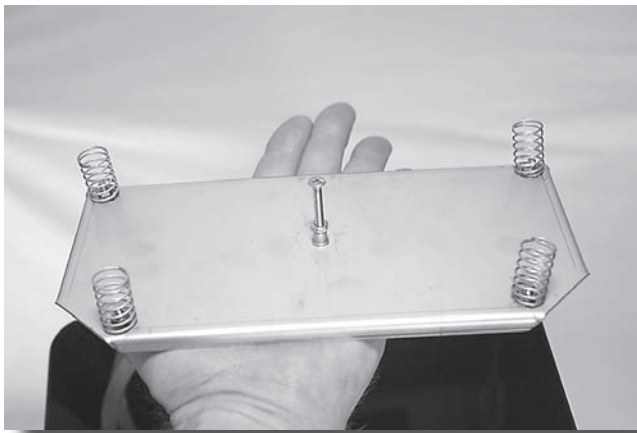

Once you have verified that your water will be of a quality appropriate for use in an espresso machine, fill the water reservoir. A funnel is recommended to prevent spilling water into the machine. Do not overfill. Filling it to just below the level where the hoses enter the reservoir is fine. Replace the cap on the reservoir.

Get into the habit of regularly checking the water level in the reservoir. The large capacity may not need filling as often as smaller machines, so it can be easy to forget to check the water level.

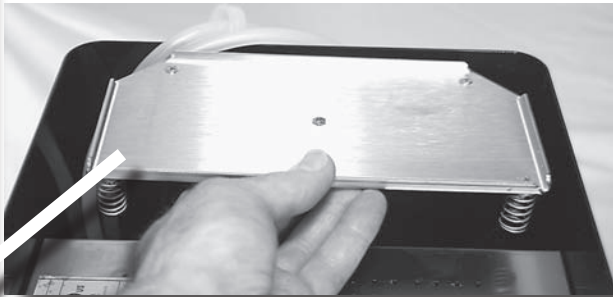

But not to worry—the switch under the reservoir will temporarily disable the machine,

including the heating element, if the water level gets low, and the Low Water Level Lamp will be illuminated on the front panel alerting you to the situation. Too remedy this situation if it occurs, simply refill the reservoir.

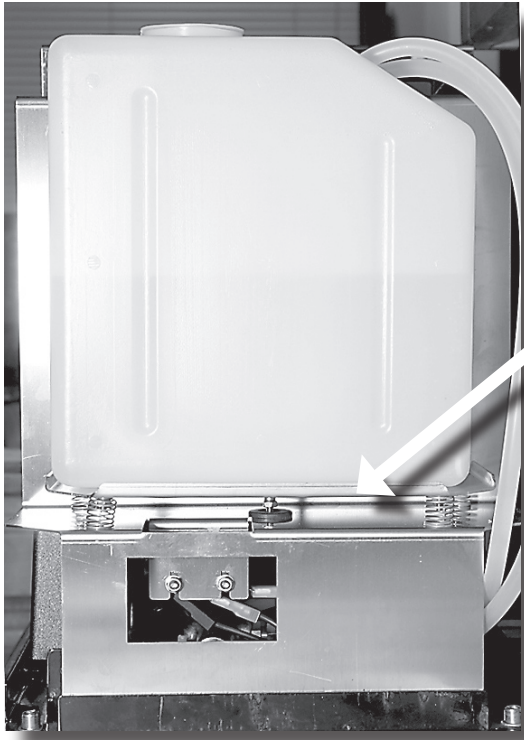

Relocate the top cover and check to see that the steam valve as well as the hot water valve are closed. **DO NOT** tighten the valves until they stop. Lightly hand tighten only. If you have the manual model be sure that the brew lever is in the full down position.

Portafilter

Locate the portafilter you wish to use. Your machine came with two- a smaller, single portafilter (shown here on the right) as well as the larger, double portafilter (left). The single is meant to create about one ounce of

espresso at a time, and the double creates about two ounces- a double. The double portafilter can also be used to make two singles at one time.

The first time you lock the portafilter in place you might find that it takes quite a force to get it tight. The proper position should have the portafilter handle pointing roughly straight towards you, perpendicular to the front of the machine. This properly seats the gasket and shower screen into place.

Leave the portafilter in place while the machine is warming up. This allows the portafilter to warm up the same as the rest of the machine.



Place a few cups that you will be using on top of the machine. The heat from the machine's normal operation will preheat the cups which serves to keep your coffee beverage warm as you enjoy it.

CAUTION: Do not place items on the top of the machine that are prone to drip or spill or might be sensitive to heat. Temperatures on top of the machine reach about 145 F. (63 C).

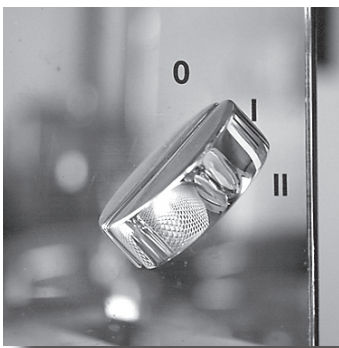

Plug the machine into a surge suppressor capable of handling 1040 joules or higher (not included). The outlet must be properly grounded and should be protected with a GFCI (ground fault circuit interrupter).

For the manual model, make sure that the lever is in the fully-down position, pushed back nearly against the front of the machine. Turn the Domobar Super's power switch to Position I as shown here. The green power indicator lamp on the far right side of the front panel will be illuminated indicating that the machine is getting power.

CAUTION: Electrical surges can damage the Vibiemme Domobar Super's electronics (all models have some electronic components in them, even the manual version). Surges can also damage the heating element. Damage caused by electrical surges is not covered by the warranty.

Within a second or two after turning the machine's power switch to Position I you should hear the pump begin to run. The sound of the pump indicates that the electronic water level control has begun to fill the boiler. When the boiler is filled to the level determined by the water level sensor, the autofill electronics will turn the pump off. When the machine arrived the boiler was empty, so it may take as long as two minutes to fill the boiler. After the pump stops, check and refill the reservoir as it will have had about half of its contents pumped into the boiler and heat exchanger.

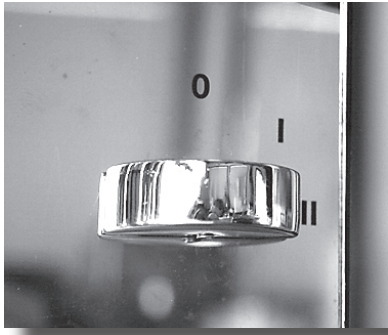

You will know that the boiler is filled to the proper level because the pump will stop operating. When the pump stops, turn the power switch to Position II as shown here. This position allows the autofill to continue working and adds heating element function. If you ever wonder why the machine is brewing with cold water, check to be sure that the power switch is in Position 2!

As the machine begins to warm up you may notice that there is a slight hissing sound coming from inside the machine. This is normal. It is the anti-vacuum valve. This valve opens as the machine cooled off the last time it was used to allow air to be drawn into the boiler to prevent a high vacuum being formed which can damage the machine. When the machine starts up it takes a little pressure to close this valve, and until it closes completely it may hiss slightly.

Wait about five minutes for the boiler to gain some heat. You should notice that the boiler pressure gauge is indicating that pressure is rising, and when it gets into its operating range you will and you will hear the pressurestat clicking on and off as it cycles in response to the boiler pressure.

CAUTION: While the boiler is coming up to pressure for the first time you should stay close by to monitor its progress to be sure that all is as it should be.

WARNING: The grouphead and other external parts will get hot enough to cause burns. Use caution when using the machine and if there are any small children in the home (or adults not accustomed to such appliances) make sure that they are aware of the dangers. Shiny chrome surfaces invite curious hands!

For this first use of the Vibiemme Domobar Super, once the pressure is above about 0.5 you should flush the boiler to be sure that the machine is working properly. Place a suitable container (like a heat-resistant glass measuring cup or stainless steaming pitcher) under the hot water spout and carefully open the hot water valve. Water should pour out and the pump should start. Pump out about 6 ounces and then close the hot water valve. Repeat this two or three times over the next five or ten minutes, and then check the reservoir level.

WARNING: The water dispensed as described above is hot enough to cause serious burns. Use caution whenever dispensing or disposing of water from the Domobar Super.

After an additional five or ten minutes of warm-up time, test the steam function. Place a vessel under the steam wand and slowly open the steam valve. Steam should come from the wand and the boiler pressure should drop slightly. After a few seconds close the valve. It is normal for some water to be pushed out of the wand with some force when the valve is first opened after the steam valve has been closed for some time.

WARNING: Steam can easily cause deep and nasty burns. The metal steam wand gets very hot. Always move the steam wand by holding the rubber sleeve and take great care whenever using the steam function.

When using the steam wand the pump may occasionally operate on its own. The steam comes off the top of the main boiler where it is “stored” all the time, and the pump will only run when the water level drops to a point determined by the depth of the water-level sensing wire.

Now it’s time to wait! We mentioned earlier that patience is a virtue when it comes to making espresso and here is our first example. The large boiler, that huge brass grouphead, the portafilter, and all the related metal parts need to come up to temperature. As the boiler comes up to temperature, hot water will circulate through the grouphead helping to speed things up, but plan on waiting about twenty or thirty minutes before the machine is ready for use.



8 - It's About The Coffee

Let's take a break just for a bit and talk about coffee. Whatever the beverage you intend to make with your new Vibiemme Domobar Super, they all start with two things- water and coffee. It should be apparent that the coffee taste of the beverage, whether it be a strait espresso, an Americano, latte, or cappuccino, comes from the coffee beans that you use.

First and foremost, it is critically important that the coffee you use be fresh. Whatever the brewing method, fresh coffee is always important, but never more so than when making espresso. If you buy coffee in bags or cans that say, "Best if Used By..." followed by a date that is months away, you can just about be sure that it is not fresh. These beans, if properly packed, may be drinkable for the first day or so after opening, but it doesn't take long for them to begin to taste stale. For espresso, coffee that is more than about two or three weeks old from the time it was roasted will probably not make the best possible beverage. The first time that you are fortunate to pull some shots using coffee that is just a day or two old you will immediately notice the difference.

If you are not roasting coffee at home, the best source of whole-bean, freshly-roasted coffee might be in your local community. Find a local coffee roaster that can supply you with fresh beans. Ask them when they roast and try to pick up your beans as close to the roasting date as possible. If you cannot find a local roaster look for an online reseller who can supply fresh beans. Don't be afraid to experiment. Order beans from various suppliers until you find something you like.

We mentioned "whole beans" in the previous paragraph. We recommend that you never use pre-ground coffee in your Domobar Super. When making espresso, the size of the coffee particles is critical and so grinder adjustment is a huge part of making espresso. Beyond that, once coffee is ground it should be used within a few minutes. Whole beans, ground per use in a quality grinder, is the only way to get the best tasting espresso from your new machine. In many ways the grinder is more important than the espresso machine!

The roast is also very important. One of the most widely-held misconceptions is that coffee beans used for espresso need to be very dark roasted. If you look at the bins of stale coffee at the supermarket you will actually see nearly-black beans in a bin marked "Espresso Roast." That couldn't possibly be much further from the truth. There is no such thing as "Espresso Roast." Very dark and oily beans are almost always over-roasted for most any coffee making method, especially espresso. If you like the taste that dark-roasted coffee gives then that is fine, but give yourself the opportunity to experience the taste of properly roasted coffee which should only exhibit a few drops of oil here and there, and have a dark oak or mahogany color to them. If there is a rule about roasting and espresso, we can say that the darker the beans the less they will taste like coffee and the more they will taste of the roast alone. Additionally, if we risk a generalization once again, the darker the roast the more bitter the espresso.

If you are in a situation where you need to store beans for more than a week or ten days, the best solution is as follows: divide the coffee into a number of two or three day portions. Place these in glass canning jars of a volume that allows each jar to be filled as fully as possible so that as much air as possible is displaced. Seal the jars tightly (vacuum packing is not necessary) and place them in your freezer- the colder the better. Remove one jar the evening before you need more coffee, in order to allow them to come up to room temperature before being opened. This eliminates condensation on the beans. When that jar is nearly empty, take out the next jar to repeat the process.



9 - Cooling Flush

One of the benefits of the Vibiemme Domobar Super line is the thermosyphon built into the E-61 grouphead. Convection acts to recirculate hot water through the grouphead which helps create thermal stability throughout the brewing path which goes a long way to helping you get consistent results. But under certain circumstances that same system can cause the grouphead and heat exchanger to become overheated, and if you do not act to control or mitigate that situation, when you pull a shot the coffee may be subjected to steam and over-heated water which will create a bitter beverage. What to do?

If the machine has been left on and has not been used for more than about three to five minutes to brew espresso, before preparing to make an espresso it is important to do a cooling flush. This involves turning on the machine as if you were going to make espresso, but without the portafilter and you don't need to use a cup. Just turn on the manual brew switch and when the sputtering of the steam ends and a stream of water without steam comes from the grouphead, count an amount of time, then turn the brew cycle off.*1 This cooling flush will pull the excess heat from the heat exchanger and grouphead, returning these parts closer to a 'normal' brewing temperature.

The second part of the cooling flush involves a short wait for the temperature of the boiler and heat exchanger to stabilize. This happens fairly quickly- figure between about fifteen to forty-five seconds. Coincidentally, that's about the amount of time it will take you to get ready. Once the cooling flush has been accomplished go about making coffee as usual- wipe the portafilter dry, grind, dose, tamp, lock the portafilter and pull the shot (this process is explained in detail in the next chapter).

As you get more accustomed to making espresso and your results become more consistent, you will be able to use this cooling flush and wait time to fine tune the process to match your tastes, the coffee you are using, and the type of drink you are making. As an example, making a cappuccino or latte you can use a slightly higher temperature so you would use a shorter cooling flush. If you are going to have a straight espresso, a slightly longer flush is required to get a smoother taste from the slightly lower brew temperature. The difference can be as little as one or two degrees, but in the world of espresso, two degrees is a lot of degrees.

How long is a "shorter" or "longer" cooling flush? That is something your taste buds will teach you as you get more and more adept at using your Domobar Super. If you find you get the same taste every time with a ten second flush, try an eight second flush for a while. Not working for you? Try a twelve second flush for a few days. These sorts of little experiments are all part of the learning process. Remember that it takes patience, practice, and attention to detail to become consistent enough to be able to tell how these little changes affect the taste of the espresso! For now, just try to do everything the same way until you get a taste that is the same every time. That might take weeks or even months. Not to worry. The skills you are learning will last a lifetime- much like your Vibiemme Domobar Super.



*1 If you are researching the E-61 grouphead and the cooling flush you will find data that suggests a flush time as low as two or three seconds all the way up to about thirty seconds. Although there are a lot of E-61 groupheads out there, the E-61 grouphead of the Domobar Super is unique as it tends to not overheat quite as much as some of its competitors. The general rule is, the longer the machine has been idle the longer the cooling flush needs to be. Start with a flush of about ten seconds and work from there. As you get more experienced you will be able to adjust your cooling-flush-and-wait procedure by taste.

10 - Grind, Dose, Tamp

Let's put it to work! If this is your first time making espresso, don't worry if things do not go quite as planned. Even the most confident and respected of baristas will pull a bad shot once in a while. There are a lot of variables that can turn what might have been a good beverage into something that should be tossed down the sink. With patience and practice you will get a feel for the process and become more and more successful in your efforts.

As we outline what you need to do to prepare coffee for pulling a shot of espresso please be aware that there is no one correct or best way to do this. Debates over this procedure continue to this day (and will likely continue for decades) and many people have written articles, and even books on this process. These simple instructions are meant to give you a starting point. Over time you will create and refine your own procedure. Think of the following as a foundation from which to build.

Your goal at this point, as we have mentioned, is consistency. You are trying to do all these tasks the same way each time. The one variable that you should be adjusting at this point is the grind which is discussed in the next chapter in greater detail.

WARM UP: You should have already chosen the portafilter and basket for your current needs (a double basket for a two ounce shot or a single basket for a one ounce shot). It should have been locked into the grouphead while the Domobar Super was warming up. At the same time, place your cups on the cup warming tray (the top of the machine, near the front). Pre-warmed cups will allow the espresso to hold its crema and taste longer.

COOLING FLUSH (if necessary): As described on the previous page, if the machine has been left on and has not been used for a while, this is the time to do a cooling flush. This signals the beginning of the procedure for making espresso.

GRIND and DOSE: Since we are about to grind coffee, let's take a brief aside to discuss the importance of the grinder itself. A huge part of espresso is a very finely ground coffee with as little dust as possible, and with particles in a controlled size range. We cannot emphasize too strongly that your choice of grinder is critical for quality espresso. You have purchased a very fine espresso machine and to get the most from it you need to use a grinder of equal quality. A high-quality grinder specifically designed to be used for espresso is highly recommended. The best of these are designed to have an infinite range of adjustment so that fine-tuning of the grind can be accomplished. For best performance, we recommend a stepless grinder. If you are shopping for a grinder or are not sure whether your grinder is up to the task at hand, please give your reseller/retailer a call to discuss what grinder will best fit your needs.

Remove the pre-heated portafilter from the grouphead and use a clean towel to wipe the inside of the basket dry. Perform the cooling flush, and then following the directions for your grinder, set it for espresso (a very fine grind, almost like flour), and grind your fresh coffee beans, slightly over-filling the basket. As you fill the basket with ground coffee try to move the portafilter just enough to help the grounds fall from the grinder in such a way so no voids are left. Getting the grind exactly correct will be discussed in detail in the next chapter.

LEVEL: Level off the mound of coffee in the portafilter using a suitable tool. The straight handle of a plastic coffee scoop works well. With some practice, even the backside of a bent finger can be used. Try to accomplish two things- the first is to not compact or compress the coffee. Work across the coffee and not downwards. The second goal is to try to fill all voids that may remain. Do that by working the coffee across in one direction and then change direction and push the coffee across again another to accomplish that goal.

TAMP: The coffee needs to be physically compressed now. A proper-sized tamper is necessary to do that. The material, handle length, and even the shape are less important than having a proper fit. It should be as large in diameter as possible without binding in the basket. The Domobars all use a 58mm tamper. The handle of the tamper should match your hand well enough that it allows you to press downwards without tipping the base.

Place the portafilter on a firm surface that is protected from the metal tips of the spout and press downward with about thirty pounds of force. For your first few attempts it is advised to use a scale to measure the amount of force it takes to accomplish that. If you are new to this process, the amount of force needed is probably a lot less than you might think!

A more advanced tamping technique would be as follows: Start by tamping with about 20 pounds of force. Remove the tamper and CAREFULLY and GENTLY, tap the top of the tamper handle against the outside of the portafilter body. The goal is to knock off any loose coffee trapped around the sides inside of the basket. Finally, tamp straight down once again with about 25-35 pounds of force. Giving a twist to the handle to “polish” off the coffee can help create a consistent surface to the coffee.

Whichever tamping method you used, the next step is to place the tamper off to the side and use your hand to wipe off the loose coffee from the edge of the basket where it will seat up against the grouphead gasket. Many baristas will invert the portafilter over the grinder’s doser to clear it of loose coffee (if you have a doserless model, do this over a small bowl). This is also a good test to assure that you have properly tamped the coffee. Do this carefully because every once in a while all the coffee will fall out of the basket!

Another variable not yet mentioned is the dose- that is, just how much coffee is the right amount? One method is to weigh the coffee. Record the weight of the complete portafilter before adding the coffee, and then weight it again after you finish the tamping. You will need an accurate gram scale with a resolution of one gram (or less) to do this accurately. Figure about 16 or 17 grams of coffee for a double and about nine grams for a single as a good starting point.

If you do not have a gram scale handy, another method is to finish tamping the coffee as before and then lock the portafilter into the grouphead, then remove it before pulling the shot. The coffee should not have been disturbed or marked by the shower screen. If it was marked or disturbed then you need to dose a bit less coffee into the basket next time.

Move the portafilter over to the grouphead and carefully lock it into place. Use caution so as not to bump the portafilter which can dislodge the coffee in the portafilter and cause a poor shot.

We are ready to make espresso!



11 - The Espresso Speedometer

It's time to actually make espresso! The coffee has been ground and tamped into the portafilter, and the portafilter locked into place. All that is left to do is to place a cup under the spout(s) and switch the machine into brewing mode (see Chapter 3 for details on how to operate the various models).

Espresso has speeds- more accurately, it has rates of flow while being created. When you switched the machine to brew, the pump pushed fresh water into the heat exchanger which displaced hot water and forced the hot water through the grouphead, through the coffee, and out of the portafilter into your cup. How it emerged, what it looks like, and how fast it flows are all indications as to how well the previous steps were performed.

How Much, How Fast?

There is a range of volume of espresso that should take a certain amount of time to be created. Whether it is a double or single, the “pull” should be about 25 seconds. The term “Pull” comes from the original espresso machines that were lever operated and the barista had to “pull” the lever to push the water through the coffee.

As the espresso issues forth from the portafilter spouts you will notice that some pulls issue forth too slowly and other pulls it might flow much too fast. There is a “sweet spot” that is sometimes referred to as the “Golden Rule of Espresso.” The general parameters that define this (for a double espresso) are about two ounces of espresso in about 25 seconds. For a single it is about one ounce in the same amount of time. We purposely state “about” because this is not so much a rule as it is just a guideline- a starting point. It should be considered just a foundation from which to begin your espresso adventure.

As you get started, don't get too caught up in timing and measuring. Excellent espresso can be made in a range of about twenty to thirty-five seconds. A very tasty double can be as little as 1.25 ounces to as much as 2.5 ounces. Think of these parameters as a bell curve with the greatest percentage of success to be at the central peak of the curve.

Learning what various flow rates look like so that you can visually identify when things are working as they should, as well as when they are not, is a good place to begin. Below you will learn how to differentiate a good pull from bad as well learn solutions to most common problems.

TOO FAST

A flow of espresso that is issuing forth too quickly will lack viscosity- it is thin and watery. The color of the stream is quite light in color which is a sign of under-extraction.

Causes of a fast, pale flow can include:

- Too coarse of a grind. Set your grinder to a finer grind. How much finer? It depends on the grinder itself. As each brand works differently you will need to experiment to learn just how much to change the grind. The faster the flow the further the grinder will need to be adjusted towards a finer setting.
- Channeling. This is usually caused either by improper distribution of the coffee before tamping or if the coffee was dosed with voids in the mass of grounds. The force of the water can bypass much of the puck and flow through without extracting properly.
- Under-dosing. There was not enough coffee in the basket and so there was not enough resistance to the flow of water.
- Too much force in the flow. This can be caused by steam build up that was not properly bled before pulling the shot. The blast of steam mixed with water disrupts the structure of the puck. This can also be caused by a improperly adjusted overpressure relief valve.
- Faulty basket. If a basket develops a crack it can flex open under brew pressure and allow the puck to be damaged causing a fast flow. If this is suspected, examine the area on the floor of the basket around the outer perimeter of the perforations which is where most cracks occur.

TOO SLOW

A slow pull can either go well over thirty seconds to get even just one ounce from a double basket, or produce very little coffee after as much as twenty seconds or longer. Often this slow flow will be very dark in color and extremely viscous- a sign of over-extraction.

Causes of a slow flow can include:

- Coffee ground too fine. Adjust the grinder one or two clicks (or settings) more coarse and try again.
- Worn or inaccurate grinder burrs. Old, worn grinder burrs or a low-quality grinder can create a lot of dust in the grind. This dust migrates towards the bottom of the basket and clogs the small openings, dramatically restricting the flow of water. This also results in a bitter beverage even under proper conditions.
- Low pump pressure. Although not likely, this can be caused by a improperly adjusted pressure relief valve.
- Clogged filter basket. If enough of the holes in the filter basket are clogged it can slow the flow sufficiently to make proper extraction difficult or impossible. Wash the basket and examine it by holding it up to a strong light source. If clogged, soak it overnight in espresso machine cleaner (See chapter 10). If that does not correct the problem you can try using a pin to clean the holes. If that does not work, replace the basket.
- Clogged shower screen. If the screen in the grouphead is not cleaned regularly it can build up deposits of coffee as well as hard water deposits that can clog it. If a clogged shower screen is suspected try backflushing (see Chapter 13).

At The Speed Limit

A delicious, proper flow creates a double of about two ounces (or a single of about one ounce) in about twenty-five seconds. It flows from the spouts like warm honey, slow and thick, and although the color may lighten a bit as it nears the end, even at its lightest color it should be a rich, caramel tone

The variables involved when choosing a grind, dosing an amount of ground coffee, and tamping can create a wide range of possibilities. A grind that is one step finer on your grinder can create a different taste if combined with a slightly smaller dose of coffee. One step the other direction (coarser) and a harder tamp with a slightly fuller dose may be preferred with the coffee you are using. Add all the other variables such as the age of the coffee, how it was roasted, and various temperatures of the brew water and things can get quite complicated!

The best advice as you begin this journey is to work at getting all these variables as consistent as possible and just change the grind to create the best espresso you can. As you improve your skills you may notice that as a batch of coffee gets older you need to change the grind slightly. You may even notice that when the humidity in the air changes you need a different grind. Don't get locked into a set routine. If something is not right in the taste of the coffee, don't hesitate to modify your technique. Try a different grind. Change the dose. If nothing seems to work, change the coffee. The art and science of making excellent espresso is the journey, enjoying the beverage is the destination, and there are a lot of roads that will lead you to that delicious drink.

Remember that we are preparing a food product. The ultimate indicator of whether a pull is successful or not is how it tastes.



12 - Steaming Milk

Making a latte or a cappuccino requires you to “stretch” milk. That involves using the steam wand to force a stream of air and steam into the milk causing the milk to increase in volume and viscosity. This is a skill that can take time to master. Although making stiff, fluffy foam is not hard, getting the fine microfoam that baristas desire is more difficult.

This process is often referred to as “stretching” because the milk can increase from twenty-five to as much as fifty percent in volume, or even more! When properly done the process gives the milk an increased sweetness and adds a delightful flavor to espresso. Adding about four ounces to a double espresso creates a cappuccino and adding about six ounces to a double creates a latte. Of course, there are no rules you need to follow- add as much or as little as you like, or make it as thick and stiff as you desire to create the beverage that pleases you or your guests. That’s the benefit of owning your own espresso machine!

If you have previously owned one of the basic, consumer-oriented machines, it may have been equipped with an enhancing attachment to the steam wand. These devices suck extra air into the steam and create a stiff foam which is not usually desired. The steam wand on the Domobar Super has two holes and a lot of steam power. Careful use of this can create excellent microfoam- injudicious use can splatter milk all over!

Another benefit of the Vibiemme Domobar Super espresso machines is the heat exchanger design. If you have previously been using one of the many home single-boiler espresso machines and have spent time waiting for steam to be available, you will immediately appreciate the fact that steam is always available for you with the Vibiemme.

How To Stretch Milk

1. Begin the preparations by pouring desired amount of milk into your steaming pitcher. There should be at least an inch or more of milk. The deeper the better, as long as there is room for the milk to swirl without spilling and to allow room for expansion. Don’t want to stretch that much milk? Use a smaller pitcher to achieve a sufficient starting depth. Having a steaming thermometer in the milk will help you learn the process a lot faster.

You also need to have a small towel or dishrag that has a portion of it soaked but not dripping. This is just to wipe off the steam wand as soon as it is removed from the milk. Not doing so will bake the milk to the wand and over time that can be difficult to remove. Fold the rag in quarters so the layers isolate your hand from the heat.

2. Start by purging the steam wand of moisture. Steam condenses back into liquid water in the steam wand’s plumbing and this must be removed before placing the wand in the pitcher. Open and close the steam valve a couple of times so that only steam comes out with no blasts of water. If you do not purge the wand, the blast of water will splash milk all over! Wait for the pressure in the boiler to rise before continuing- it will only take a few seconds.

CAUTION: Steam is very hot and capable of causing very serious burns. The metal steam wand will also be very hot and even a brief touch can cause burns. Use the rubber safety cover on the wand when moving its position! Steam can easily go through a towel or rag, so use care when wiping the wand!

NOTE: When closing either the steam or hot water valve, close them just tight enough to stop leaks or drips. Over-tightening the valves will shorten the life of the seals inside.

3. Take the already-filled steaming pitcher in hand and get ready. After the last blast when clearing the wand, and as soon as the boiler pressure rises, place the pitcher under the wand and lift the pitcher until the tip of the steaming wand is below the surface of the milk, then carefully and slowly open the steam valve.

How much should you open the valve? About 1/4 to 1/2 turn. If you are not accustomed to a commercial-quality machine you will be surprised at the power of the steam. You do not need to use all that power, and that is particularly true for new users. At this setting you are getting all the steam power you need and opening it up further gives no benefit. It actually will be a detriment because it will take a lot longer to stop the steam when the

process has finished and you take the risk of overheating the milk and ruining your efforts. Remember, this is a commercial-quality machine and it delivers commercial-level performance!

4. Within the first few seconds the steam should be moving the milk in a circular action. If the milk is splashing like a boiling pot, reposition and/or change the angle of the pitcher in relation to the steam wand. Coordinating the pitcher's angle, the depth of the wand, and the amount to open the steam valve to create an appropriate force takes practice. Don't get discouraged. A good starting position is having the tip right in the center of the pitcher pointing straight down.

5. Now that the milk is moving, lower the pitcher just far enough so that the wand is now a little closer to the surface. It should sound a little like ripping cloth. There is a very delicate balance between drawing in a bit of air and a splashing, foamy mess. If done correctly you will hear sounds like "Tshhh.. Tshhhh.. Tssshh." If the tip of the wand is too close to the surface, the steam force will pull in too much air and you will hear, "BLURBBB BLUBB BLURRB." Watch the surface of the milk- if you are creating large, visible bubbles (like dish-washing suds) on the surface of the milk it means that the air is being drawn in too quickly because the tip is too close to the surface.

Although that sounds easy, finding the balance requires a delicate touch. Relax your hands and arms and let the machine do the work, but be ready to adjust the pitcher. You will learn to predict the milk's behavior over time. As the milk changes in volume and content you will need to continually adjust the height of the pitcher. Do so carefully. Some of the milk on the surface may actually be foam and the power of the steam can push it into the milk causing the milk to cavitate which will bring on the dreaded BLURRBS! Holding the tip at too great of a depth during this part of the procedure will keep the steam from pulling in air, and about all you will get is a pot of very hot milk. Patience and practice will help you prevail.

6. After about the first five to ten seconds of introducing air in this way the milk will hit the 100 F. (40 C.) and it will be time to raise the pitcher to more deeply immerse the wand so that no more air is being drawn in. Now the steam is breaking up the tiny bubbles in the milk and creating micro-foam.

7. As with any fine art, one of the important lessons to learn is when to stop. When in doubt, it is generally better to stop sooner than later. A steaming thermometer can be a big help here. When you hit about 135 F. (57 C.) degrees you need to have your hand on the steam valve because you should not go much past 140 F. (60 C.). Stopping the steam there you will notice that the thermometer will continue to climb a bit more to about 145-150 F. (63-66 C.). If you get the milk too hot it will rapidly lose its stretch and volume. Practice timing when to stop so the milk hits no more than about 150 F. (66 C.).

How can you tell when you have gone far enough and have the right sort of consistency? Besides using the thermometer, if you have good light to enable you to see the surface of the milk, during this final stretching phase you may see the surface of the milk change in the way it reflects light. The milk will go from a flat white like latex paint and it will turn into a shiny, almost iridescent white with the sheen of silk.

8. When you think it is time to stop, by all means do so, and don't hesitate. It is better to stop just a bit too soon than going a bit too long! Holding the pitcher by the handle in one hand and holding the steam valve in the other makes it easier to stop when the time is right.

Are you ready to stop? Close the steam valve and while holding the pitcher still, pick up the wet rag with your free hand and then remove the pitcher from under the wand. As soon as it is exposed, use the wet rag to wipe the wand to remove the milk residue. Now give the steam wand a quick blast to clear it of any milk residue which may have gotten into the steam wand through the holes in the tip.

CAUTION: At this point the milk in the pitcher can be quite hot. Remove the pitcher carefully and only after the flow of steam has nearly stopped. Removing the pitcher from the wand too soon can cause splattering of very hot milk. Use care when wiping the wand as the metal parts it will be very hot.

9. Examine the milk in the pitcher. If there are any large bubbles try knocking the pitcher downward on the counter to pop them. Do so gently so as not to "bounce" milk out of the pitcher. Now swirl the pitcher by placing its bottom flat on the counter and swirl the pitcher in small circles to homogenize the stretched milk.

10. Pour yourself a cappuccino or a latte.

Milk Stretching Tips

- It is generally best to pull your espresso shot first and then steam the milk. If milk is allowed to sit for long it loses its texture. For milk-based drinks, whatever flavor might be lost in the espresso from sitting for a minute or two won't be sensed in a milk-laden beverage. As you become more experienced you can simultaneously stretch the milk while the shot of espresso is being created.
- Using a correctly shaped pitcher can help. The best are the ones that look like a bell- wider at the bottom then at the top. The narrowing helps keep the milk contained when the steam tries to force it up out of the pitcher.
- Use a quality milk. The bargain brands are often from cows fed a low-quality feed or silage and the milk is more difficult to stretch and does not hold the stretch as well. Try a good 2%. Once you get better at this you can experiment. For an indulgent treat, try mixing two parts milk with one part cream or half-and-half.
- Soymilk can also be used. Experiment to find one that suits our taste and style of steaming. As with cow milk, soymilk comes in different quality ranges, and some stretch better than others. Try several to find one that works for you. Generally speaking, soymilk will not create the sort of quality microfoam that can be had from cow milk, nor will it hold its stretch as long.
- If things are going too fast as you begin learning, try placing the pitcher as well as the milk in the freezer for about five or ten minutes before use. The colder the milk, the more time you will have to work it.
- A pitcher that is sized to the task helps. A 28 ounce steaming pitcher with only four ounces of milk in it will be impossible to work.
- To practice getting the proper position, “stretch” some water in a clear vessel to get a better idea of what is going on in there. Be sure to use a vessel made from heat-resistant glass! You will need to refill with cold water after about 20 seconds of steaming time, otherwise the water will come to a full boil.
- Somewhat like trying to un-cook an egg, once milk has been steamed it is done, and if it didn't come out right, either live with it or toss it down the sink and try again.
- Take your time. The valve controlling the steaming does not have to be opened all the way. Rushing things does not give the milk time to develop. On the other side of the coin, if done too slowly there will not be enough air drawn into the milk and all you will have is hot milk.
- There is a very small sweet spot where how hot, how much air, and how long did it took, all come together to create perfect microfoam; this is a stretched milk that is not stiff, but is more viscous than milk before it was stretched. There is nothing wrong with stiff, spoonable milk if that is what you like, but this stiff foam does not add the same texture, feel, or sweetness like perfect microfoam.
- When steaming the milk, place your free hand on the side of the pitcher. Watch the thermometer as you feel the temperature of the metal pitcher and you will soon learn what 140 degrees feels like and at that point you will no longer need to use the thermometer.

With practice and patience, you will find your steaming technique improve over time, and you will soon be proud of the drinks you are serving.



13 - Cleaning and Maintenance

As with all fine tools, the Vibiemme Domobar Super can give you years of trouble-free service and better performance if properly maintained. Your Vibiemme Domobar Super does require a bit of care, but it is not at all difficult.

Although the following guidelines will give you some idea of how often the tasks should be performed, there is no specific set of rules concerning the frequency of cleaning and maintenance. A machine that is being used to make two or three drinks each day in a home environment will not need to be cleaned quite as often as a machine used in an office or restaurant where it is called upon to make fifty drinks a day. If in doubt, it is better to do cleaning and maintenance chores a little too often than not often enough.

After Each Pull

Knock Puck - After the pull the spent coffee puck in the portafilter should be knocked out. The best way is to use a knock box. These feature a cushioned bar with a soft surface that protects the portafilter from damage.

Quick Flush - As soon as you remove the portafilter from the grouphead after a pull, cycle the brew function for about one second or so. This will help flush out any coffee on or behind the shower screen.

Flush Portafilter - If you are not immediately going to pull another shot, replace the portafilter and repeat the quick flush. Pushing a bit of clean water through the portafilter will remove most of the left-over coffee in the portafilter. Remove and wipe it off after the flush. If the machine is going to be left on, leave the portafilter in place so that it can remain warm.

After Each Stretching of Milk - The steam wand must be wiped off immediately after every use with a damp towel or dish rag after removing the wand from the milk. As soon as the wand is wiped, the steam valve should be briefly opened and closed to create a blast of steam to force out the remaining milk that may be in the wand. Allowing milk to sit on (or in) the wand will cause the milk to bake onto the hot metal. This is not only unsanitary but can also become very difficult to remove. If you do have baked on milk we do not recommend soaking the wand in a pitcher. This can cause dirty water to be drawn into the wand, and under certain conditions, possibly into the boiler. Difficult-to-remove milk can be cleaned using Urnex Rinza which is specially formulated for this task.

WARNING: The steam wand can be very hot. Avoid touching the wand directly and use caution when wiping the wand. The heat can cause the water on the rag to turn to steam which can cause a burn.

After Each Session

Grouphead - The area where the portafilter locks into place gets exposed to a lot of coffee and must be kept clean. Coffee residue left here will not only degrade performance over time but can also detrimentally affect the taste of the coffee.

At the end of each session use the grouphead brush which was included with your Vibiemme Domobar Super to clean the screen as well as to give the area in which the grouphead gasket resides a good scrubbing.

Portafilter - At the end of each session the portafilter should be rinsed under hot, running water and dried off before storage. While it should be left in place on the grouphead during use, if the machine is being turned off, the portafilter should be stored elsewhere so that the moisture can evaporate from the grouphead. Otherwise it can stagnate in there.

Daily Blind Flush- At the end of each day (or when you are through using the machine for that day) you should do a blind flush:

- 1) Remove a filter basket from either of the portafilters and insert the blind basket in its place. The blind filter basket is the one that has no holes in it.
- 2) Lock the portafilter into place just like you would to make espresso.
- 3) Manually engage the brew function

- 4) Watch the brew pressure gauge and when pressure builds to about 9 BAR, turn the brew function off.
- 5) Repeat steps 3 and 4 two or three times.
- 6) Loosen but do not remove the portafilter and turn on the brew switch again. Wiggle the handle to loosen the portafilter a bit so that water can flush the area around the grouphead.

WARNING: Hot water will spill out and pour onto the drip tray. Use caution to avoid burns from the splashing hot water.

Once Every One Or Two Weeks

Backflushing

This is the process of forcing some special cleaner back through the grouphead. This will remove any stray coffee left in the places that normal, day-to-day cleaning cannot reach. How often this should be done depends on how much use the machine gets, the coffee you use, as well as the amount of coffee you use for each pull. If you are making one or two beverages a day then once every one or two weeks is probably sufficient. If you are making around four to six doubles a day then once per week is probably a good idea. If the machine is being used all day (such as in an office or small restaurant) then backflush every day.

Your Domobar Super was supplied with a blind filter to be used to backflush. This is the basket with no holes in it. To use it, follow these simple instructions:

WARNING: The cleaning agent is quite strong. Follow all safety recommendations on the cleaner's packaging. Only use chemicals designated for backflushing. Other cleaners can cause problems or even damage to your machine.

- 1) Insert the blind filter into one of the portafilters.
- 2) Place a small amount of espresso machine cleaner into the basket (see manufacturer's instructions for specific amounts to be used).
- 3) Lock the portafilter into place just like you would to make espresso.
- 4) Manually engage the brew function
- 5) Watch the brew pressure gauge and when pressure builds to about 9 BAR, turn the brew function off.
- 6) Repeat steps 4 and 5 until you see the suds of the cleaning agent appear in the drip tray (removing the drip tray cover during this process can help you see what is going on). Wait about two or three minutes, then repeat steps 4 and 5 once again.
- 7) After two or three cycles like this, loosen but do not remove the portafilter and turn on the brew switch again. Wiggle the handle and allow the cleaner to be flushed up into the grouphead. The cleaner will overflow the portafilter and clean the area up inside the grouphead of coffee.

WARNING: Hot water and cleaning agent will spill out. Use caution to avoid burns or exposure to the cleaner. Wear eye protection to prevent injury.

- 8) When the suds coming through the 3-way valve appear to be clean and free from coffee residue, empty and clean the drip tray and the portafilter. Replace the drip tray and run a bit more water through the grouphead so it is free from cleaner. Replace the portafilter and repeat steps 3 through 5 until the water runs clean into the drip tray. Repeat step 7 to rinse any remaining cleaner from the grouphead.
- 9) Remove the blind filter, rinse the portafilter assembly, and you are done. It is suggested that the first pull after backflushing be discarded just in case a bit of cleaner is left that could taint the coffee.

CAUTION: The cleaning products meant for backflushing must NEVER be used in the water reservoir. Using this cleaning agent in any way other than described here can damage your machine and void your warranty.

Cleaning the Portafilter and Filter Basket - Pop the filter basket out of the portafilter body. Using a fingernail is not recommended as these commercial portafilters have a very stiff retaining spring inside. Using the back edge of an old butter knife as a lever between the portafilter body and basket edge works quite well.

Dissolve a bit of espresso machine cleaner in hot water in a glass container. The solution can also be used to clean the portafilter body as well as the portafilter baskets and any other similar parts soiled with coffee. These parts can be disassembled and soaked overnight if necessary to remove stubborn stains, but soaking them for five to ten minutes is usually more than sufficient for properly maintained parts.

As Necessary

Exterior Cleaning

NEVER use any abrasive cleaners or cleaning pads on your Domobar Super. They WILL scratch the surface. A quality glass cleaner sprayed on a rag will usually do a good job of cleaning the outer surfaces, but do not spray these in the area of the grouphead, and always wait for the machine to cool before cleaning the exterior. For more difficult stains try alcohol on a microfiber rag, or really tough stains can be removed with a little Urnex Clearly Coffee. If your machine has painted panels take care to use products that are compatible with powder coating. No solvents should ever be used as these may permanently damage the powder coating's sheen.

Grouphead Gasket Replacement

The thick, rubber gasket that seals the portafilter in the grouphead is subjected to a lot of heat and pressure. Over time it will harden and the portafilter's action will create a depression in the surface. If it begins to leak, the first resolution is to give it a good cleaning as mentioned above. If that does not cure the problem then replacement is the next step. Before attempting this it is a good idea to have the spare gasket as well as a spare shower screen on hand.

The most difficult thing about replacing the grouphead gasket is removing the old one. Depending on just how hard or old the existing gasket is will dictate the difficulty of removing it. First try removing it by gently prying it out. Use a small screwdriver or a paint can opener. Take care not to damage the chrome surface of the grouphead.

If that does not seem to be working, the next step is to use one or two drywall screws. Try using a single one at first and screw it directly into the black, rubber gasket, then grasp it with a pair of pliers and pull it out (be careful not to scrape your knuckles if the screw suddenly pulls out). Placing another, 180 degrees from the first will allow pulling on one side then the other to work it out of the grouphead. If the screw just pulls out of the rubber, use a larger-diameter wood screw, file off the pointed tip so it is flat, and screw it into the gasket in the same hole made by the drywall screw until it touches the grouphead, and then continue turning the screw. As it penetrates the gasket and hits the grouphead it will pull the gasket down the screw. If this isn't working, try repeating the process with a second wood screw in the other hole.

If you do this and the gasket breaks that is fine. You can then just pry it out with a small screwdriver or ice pick. Use care not to mar the grouphead. It is a very good idea to have a spare shower screen on hand when attempting this job. The screen is held in place by the gasket, and if you have to go at the gasket with vigor the shower screen can be damaged. Having a spare on hand will limit downtime.

Once the gasket is out, remove the shower screen and give the area a good cleaning. Be sure that no old gasket or coffee residue is left in the grouphead. If need be, use a brass-bristle brush to clean the area.

To install the new gasket, assemble the gasket over the shower screen and place them on a portafilter, maneuver the assembly into place and then simply lock the portafilter into place as you would when making espresso. The cam-action of the portafilter locking into place will push the shower screen and gasket into place.

How often this needs to be done depends on many factors, but for in home use about once every six months

to one year is usually sufficient. Otherwise, change it when you feel it lacking in resiliency when locking the portafilter in place or when leaks occur that are not resolved by other solutions as mentioned above.

Hot Water Wand



The tip of the hot water wand is removable and can be cleaned after removing it from the machine. It simply unscrews, but do not use pliers or other similar tool that may mar the finish. A small strap wrench is preferable if a tool is needed.

Here is an image of the parts disassembled so you can see how they go back together. Note the black O-ring still on the wand. Be sure it is there when reassembling. All parts are shown here with the correct side facing upwards, and in order of assembly, starting with the part on the right.

Steam Wand



The steam wand can become clogged if a cleaning is missed after steaming milk. The tip can be removed by unscrewing. Remove the tip and soak it in cleaner, overnight if necessary. Note the O-ring. It fits in the slot of the tip. Be sure the O-ring is used when assembling.

Long Term Storage

The boiler and heat exchanger contain water. Because of that, if the Domobar is not going to be used for a while or is being placed into storage some factors must be considered.

The first is temperature. If it can be avoided the machine should never be stored where it will be subjected to freezing temperatures. If there is water in the machine that is allowed to freeze, a lot of damage can be done as the water expands when it turns to ice.

Try to avoid damage by freezing:

Although there are steps that can be taken to remove some of the water in the boiler, heat exchanger, brew-head, and all the pipes and hoses, it is very difficult to get all the water out. If you suspect that your Vibiemme espresso machine may be left where it could be subjected to freezing conditions, check with your local RV supply store. They sell antifreeze chemicals designed to be used in drinking water systems. Be sure that the additives are safe to use on brass, copper, plastic, and chrome parts. Follow the instructions precisely

After treating with these chemicals, tape over the power plug and tape a note to the machine and the power cord at the plug end warning of the addition of these chemicals, and add a warning to completely flush the machine before use! Be sure to completely flush the system before energizing the heating element when putting the machine back into service.

WARNING: Neither damage from these sorts of chemicals nor damage from freezing are covered by the warranty. Use of these chemicals and storage in freezing conditions is to be done at your own risk.

Placing a Machine Back Into Service After Storage

Even if not stored in such extreme conditions as mentioned above, when placing a stored machine back into service you must flush out the machine with fresh water to remove any stale water that was left in the boiler, the heat exchanger, and in the various pipes and hoses. To do so:

- 1) First wash the water reservoir, then fill it with water.
- 2) Turn the power switch to Position I. After the initial cycle of the pump stops, turn the switch to Position II and wait for pressure to build in the boiler.
- 3) When the boiler pressure is at or above .5 ATM, open the hot water tap and pump about 6 ounces of water into an appropriate vessel. Repeat that four times, waiting between glasses for the pump to stop which signifies that the boiler has been refilled.
- 4) Now pull three or four double shots without using coffee, then do a clean water backflush.
- 5) Check the reservoir water level.
- 6) Allow the machine to fully warm up and you are ready, once again, to make espresso.



14 - De-scaling

WARNING: De-scaling involves pumping a chemical solution through the machine. These special chemicals usually contain a food-grade acid that can be hazardous. Carefully follow the manufacturer's recommendations and use safety precautions. Even when working carefully some of it may splash about. Gloves and eye protection are required when handling and using these chemicals. Do not allow spectators in the area.

CAUTION: The acidic solution can splash when de-scaling. Protect the working surface under and around the machine and immediately wash off any that splashes, particularly on the painted surfaces. Do not touch your face or eyes during this as the de-scaler can cause serious irritation and burns to sensitive tissues.

Depending on the mineral content of your water and how often it gets used you should de-scale the Vibiemme Domobar Super's boiler, heat exchanger, and brewing path at least twice a year. As water is repeatedly heated and some of it boils off as steam, some of the mineral content in the water is left behind. These form hard water deposits which can cause problems such as:

- failure of the water sensor to function properly
- heating element failure
- clogging of the thermosyphon pipes
- low brewing volume
- poor pressurestat response
- low-temperature grouphead
- drips and leaks from the grouphead
- inability to form pressure in the boiler due to vacuum breaker failure

De-scaling is a preventative maintenance chore that can help avoid these problems and will significantly prolong the life of your Domobar Super.

WARNING!: De-scaling involves opening the case of the machine which exposes the internal working components. Electrical components and their wiring can present a shock hazard and many parts inside the machine can get very hot!

CAUTION: Only use products that explicitly state that they are intended for the removal of mineral deposits in the boilers of espresso machines. Other products, such as those made for cleaning coffee pots or removing hard water scale from bathrooms must never be used! No other chemicals should ever be used for this purpose, and this is the only agent that should ever be added to the water tank. Always follow the manufacturer's recommendation and instructions when de-scaling an espresso machine. Use of improper cleaners in the boiler can void the warranty, damage numerous parts of the espresso machine, and may be harmful to your health.

How to Descale

- 1) If the machine is so equipped, remove the water softener device from the water tank, and install the original particle filter that fits the end of the hose. The descaling agent will permanently damage the water softener if it is left in place during this process! Do not reinstall it until this entire procedure is completed. The original filter will stop any foreign matter from entering the boiler or the heat exchanger.
- 2) Turn the power switch to Position 0 (off) and unplug the machine.
- 3) Pull the hoses out of the reservoir and remove the reservoir and its platform from the machine.

- 4) Tip the machine on its back and remove the two, small Phillips head screws on the bottom of the machine along the back edge of the bottom. Stand the machine back on its feet
- 5) Remove the 6 screws on the outer case (three on each side). Slide the outer case off the machine
- 6) Replace the water reservoir's platform and the reservoir and replace the hoses back into the reservoir.
- 7) Pour the de-scaling agent into the water reservoir. You will need to fill it at least 1/2 full. Be sure to follow the manufacturer's recommendations as to the mixing of the de-scaler to the proper concentration.
- 8) Plug the machine in and turn the power switch to Position I only! Allow the boiler to fill. Continue to the next step after the pump stops.

WARNING: In many of the following steps, such as when pumping the de-scaler through the group-head and removing the hoses from the water tank, splashing acid can create a safety hazard. Gloves, eye protection, and protection for the working surface are required.

- 9) Place a suitable container under the grouphead and turn on the brew function to run about eight ounces out of the machine to get the de-scaling agent through the grouphead. This also ensures that the thermosyphon pipes, the inside of the heat exchanger and internal portions of the grouphead get de-scaled.

CAUTION: If the used de-scaling agent is poured down a drain, allow the faucet to run into the sink to dilute the acid. Never re-use the spent acid.

- 10) Snap the blind filter into the portafilter handle and backflush the machine. Turn on the brew function and allow it to run for about five seconds. This will force the de-scaler through the over pressure relief valve. You will see the liquid flowing back into the reservoir through the secondary hose. When that takes place, turn the machine to "0" and unplug the power cord. Leave the hoses in place and move the reservoir off to the side of the machine and lift off the reservoir platform.

- 11) Remove the two Phillips head screws holding the top of the divider panel and swing it back and off the machine. Take care not to stress the wires attached to the water-level microswitch which is attached to the panel.

- 12) Remove the water level sensor wire by loosening the screw indicated in these two photos. Leave it disconnected for now. This will fool the boiler into thinking that the boiler is low on water and needs to be refilled. Set the wire off to the side where it cannot accidentally connect with any metal parts.

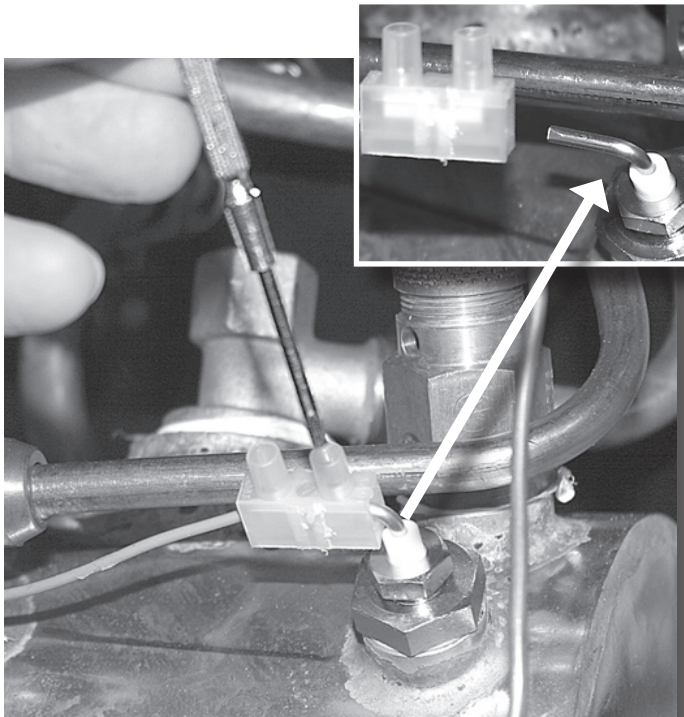

- 13) Replace the divider panel and reinstall the two Phillips head screws holding the top of the divider panel in place. Reinstall the reservoir platform and reservoir and insert the hoses once again. If needed, refill the reservoir with de-scaling agent.

- 14) With the autofill wire still disconnected, plug the machine back in, remove the tip and O-ring from the steam wand and place them off to the side. Place a suitable container under the steam wand and the hot water wand and open the steam valve.

- 15) Turn the power switch to position "I" only. The autofill is defeated and so the machine will overfill (completely fill) the boiler. As soon as a solid stream comes out of the steam wand, turn the power switch to Position 0 and close the steam valve.

- 16) Place a suitable container under the hot water wand. Open the hot water valve and turn the power switch to Position I. Pump about 16 ounces of solution through the wand. Turn the Power Switch to Position 0 and then close the hot water tap and unplug the machine.
- 17) At this point, the de-scaling agent has been pushed through all possible avenues where water can be passed. Leave the machine off, unplug the power cord, and allow the machine to sit for a few hours. Refer to the instructions on the de-scaling agent's container for a better idea of how long this should take. The amount of soaking time is also a matter of the mineral content of your water, how much use your machine gets, and how long it has been since the last de-scaling.
- 18) After the requisite time has passed, place a suitable vessel under the hot water tap, plug in the machine, open the hot water valve, and turn the power switch to Position I. Pump about 8 ounces of solution through the wand. Turn the Power Switch to position 0 and then close the hot water tap and unplug the machine. If the liquid you drained looks quite fouled with scale, refill the reservoir with de-scaling agent by pumping another 16 ounces of cleaner through the hot water wand (repeating the process starting back at step 15. Excessive scale in the drained water indicates that you need to de-scale more often. If the water does not look very polluted with hard water deposits that have been dissolved, continue with step 18.
- 18) Empty and thoroughly wash and rinse the water reservoir, fill it with the water you normally use in the machine, and replace the hose with the particle filter in the end back into the reservoir (if used, do not replace the water softener yet).
- 19) Place the bypass hose in a suitable container. Removing this hose from the reservoir will keep the water in the reservoir free from the de-scaler which is still in the pressure relief system.
- 20) Place a container under the grouphead, turn the power switch to Position I and immediately turn on the brew cycle for fifteen seconds or more to flush out the grouphead and thermosyphon pipes. Turn off the brew cycle and immediately turn the Power Switch to position 0.
- 21) Lock the Portafilter with the blind filter basket in place on the grouphead. Turn the Power Switch to Position I and run the brew cycle for five or ten seconds after the brew pressure gauge reaches about 9 BAR to flush the over pressure relief valve. Turn off the Brew Cycle and turn the Power Switch to Position 0.
- 22) Remove, rinse, and replace the blind portafilter. Turn the Power Switch to Position I and turn the brew cycle on and off a few times as when you are backflushing to clear the rest of the grouphead. Turn the brew cycle off and turn the Power Switch to Position 0.
- 23) With the autofill wire still disconnected, place a suitable container under the steam wand and open the steam valve. Turn the power switch to position "I" only. The autofill is defeated and so the machine will pump a stream of water through the steam wand. Continue pumping until the water is clean and is free of descaling agent. Close the valve and set the Power Switch to Position 0. Remember to check the reservoir level during this process.
- 24) Once again, place a suitable vessel under the hot water tap, open the hot water tap and turn the Power Switch to Position I. Allow a stream of water to come from the steam wand until the water is clean and is free of descaling agent. Close the valve and set the Power Switch to Position 0.
- 25) Repeat steps 18 through 24 until the water you drain is tasteless (totally free from the taste of the cleaner). This might take as many as three or more rinses.

CAUTION: Most proper de-scaling agents are a form of citric acid which is food grade, and in highly diluted form is safe to consume. Sample only a very small amount (one drop on a clean fingertip) to be safe. Thoroughly wash your hands in hot, soapy water before and after doing this test.

- 26) When the drain water is clean and free from the acidic taste of the cleaner, turn the power switch to "0" and unplug the machine.

27) Remove the reservoir and the reservoir platform, remove the two screws holding the divider panel, tip the panel back, and replace the autofill sensor wire on the boiler.

CAUTION: Failure to replace the autofill wire will cause your Vibiemme Domobar to behave erratically and can cause damage to the machine not covered by the warranty.

28) Move the internal partition panel back into place and fasten with the two upper Phillips head screws.

29) Tip the machine onto its back and install the two small Phillips head screws in the bottom that hold the internal partition.

30) Place the machine upright and replace the outer cover and fasten the 6 Phillips head screws that hold it in place. Take care not to pinch the two hoses that go into the water reservoir.

31) Replace the water reservoir platform, the water reservoir, reinstall the water softener if so equipped, wipe the two hoses clean and replace them in their proper locations in the reservoir. Refill the water reservoir with the water normally used in the machine. If you found heavy deposits of minerals were removed from the machine during the de-scaling process, think seriously about using a different source for your water or a different treatment of the water. Also check the hardness of your water at more frequent intervals.

32) Plug the machine back in and turn the Power Switch to Position I. The pump should not start. Place a suitable container under the hot water wand and open the hot water valve. Turn the switch to Position II. As the machine heats up some of the excess water in the boiler will be displaced by the steam. When the pump begins to operate signifying that water has been lowered to about the correct level, close the hot water tap. The pump should stop shortly after closing the tap.

WARNING: Do not leave the machine unattended until the proper water level in the boiler has been verified!

33) When the machine comes up to temperature, bleed steam off the boiler to assure that the water level is correct. If a lot of water comes out then the water level is too high. Repeat Step 32. If this problem continues, consult your retailer/reseller.

33) Now that the machine is up to temperature, flush a good amount of clean water through the hot water wand, bleed some steam out of the steam wand, and run the brew cycle to clear about four to six ounces of water through the grouphead to be sure they are clear of de-scaling agent. Save a few ounces of water and when it cools, taste it. If the water tastes like the acid used in the cleaning agent, repeat the flush process until the water is free from the acidic taste of the de-scaler.



15 - Hints, Tips, and Tricks

We have already reviewed some of the ways that you can control the way the Domobar Super operates. The best example is the cooling flush which allows you equalize and control the brewing temperature throughout the brewing path as well as eliminate any steam that may have built up during an extended idling period. There are other procedures that you can use to gain further control over the way your Vibiemme operates.

Maximizing Steaming Power

You probably have noticed that the heating element cycles on and off while the machine is in operation and even when it is idling. That can be seen by watching the heating element indicator lamp on the control panel. That cycling can be used to your advantage when steaming milk. For the greatest production of steam throughout the steaming cycle, start steaming just before the heating element turns off. You can judge this by watching the indicator lamp in conjunction with the boiler pressure gauge. The goal is to begin steaming when the boiler is as hot as its range allows while the heating element is still energized. As you draw off steam the pressure in the boiler (and thus the temperature) will drop slightly which keeps the heating element energized. With a little practice you will be able to do this without hardly even thinking about it.

Minimizing Temperature Variations During the Pull

A similar procedure can be used for the brew cycle. The best time to begin pulling a shot is when the heating element has just turned off. This gives a bit more temperature stability as well because it eliminates the variable of the heating element coming on during the pull. If the heating element comes on during a pull you will hear the pump lose a bit of power because the heating element is drawing a large percentage of the current available on the circuit. If the circuit that feeds electricity to your Domobar Super is being challenged by the demands of the machine, this procedure will help lessen that load.

Electronic Domobar

If you have the electronic model which allows you to program the dose for each of the four buttons, and would like to make things easier on yourself, try this:

You probably do not use all 4 of the programmable buttons for brewing. Pick one and program it to do your cooling flush automatically! Just program for about a ten second pull. When ready to pull a shot just press the “flush” button and the machine will automatically perform the cooling flush itself while you are preparing the portafilter for the next pull. This is more convenient and faster than using the manual button to perform the cooling flush.

Minimizing Mineral Buildup

Mineral buildup in the boiler can be minimized by using the proper quality water and by de-scaling as mentioned previously. Another way to lessen this scale accumulation is to pump water out of the boiler occasionally. This is particularly important if you rarely use the hot-water function of the Domobar Super. To refresh the water in the boiler simply place a heat-resistant vessel under the hot water wand and open the valve. Dispense about 8 ounces and then allow the boiler to refill before proceeding. Repeat this two or three times. Doing so every one or two weeks will help minimize scale build up.

16 - Advanced Adjustments

The tasks listed in this section are not usually necessary. These adjustments are for the advanced user who wants to fine-tune the operation of the machine or to compensate for changes in the way the machine operates over time. These usually do not need to be changed more than maybe once or twice a year, if that.

Brew Pressure Adjustment

CAUTION: Care should be taken when adjusting the pressure relief valve. Setting a too-high pressure will not only make it difficult to get good tasting coffee but could cause other problems and accelerated component wear. Setting it too low will necessitate a much more coarse grind and will negatively affect the taste of the espresso.

The pump in your Vibiemme Domobar Super is capable of developing pressure far greater than needed to make espresso. If all of that pressure is allowed to reach the coffee, over-extraction is the result. To control the maximum pressure that can reach the coffee there is an adjustable pressure regulator at the output side of the pump.

In situations that sufficiently restrict the flow of the pump causing it to develop high pressure, the relief valve opens and allows some of the water being pumped to travel through a special hose back into the water reservoir. That is the function of the second hose in the reservoir without a filter at its end. In actual operation the relief valve will open and close as needed, to the extent needed- sometimes open slightly to allow a trickle to pass, other times allowing a greater flow, and sometimes not opening at all.

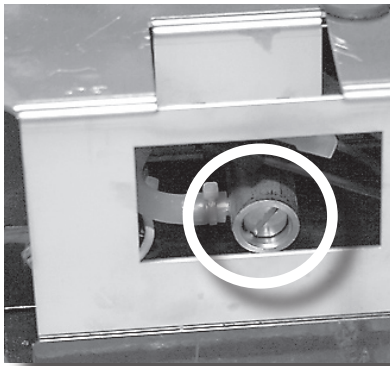

The valve is adjustable and the user can set it to their liking. Be aware that the brew pressure gauge on the front panel reads a slightly higher pressure than the extracting pressure you desire in the grouphead. If you rely solely on the gauge's reading to make adjustments, odds are that the brew pressure will be too low. It reads about 1 ATM higher than the pressure that reaches the coffee.

To make adjustments to the brewing pressure, remove the rear cover by unscrewing the six screws (three on each side of the machine) and you will see the OPV valve through an opening directly below the water reservoir.

Insert the blind filter and turn the power switch to Position I. Turn on a brew cycle and when the gauge settles in after about ten seconds, adjust the relief valve.

**CLOCKWISE RAISES the PRESSURE
COUNTERCLOCKWISE LOWERS the PRESSURE**

Turning the screw clockwise (tighter) increases the brew pressure, and turning it counterclockwise (loosening) lowers the brewing pressure.

CAUTION: The adjustment is extremely sensitive and only very small movements of the screw should be made when searching for a proper pressure. Generally speaking, less than the width of the slot of the adjusting screw is sufficient. After having the brew function on for about 45 seconds, turn off the brew cycle and allow the pump to rest for one or two minutes to avoid overheating the pump.

WARNING: there are sharp edges around the divider panel. Use caution when adjusting the over pressure relief valve.

A slightly higher water pressure will work well for darker roasts, and a slightly lower pressure is best for lighter roasts. Since it is a bit of work to access the regulator, if and when you feel the need to adjust it, make a

small adjustment keeping in mind that it should be set to best match the coffee you drink most of the time. The best test to judge the setting is your palate, but it will take time and practice to get consistent enough to sense the difference in taste.

The pressure gauge on the front panel should only be used as a general indicator as to what is happening during the brewing cycle. The only time when the gauge will display any useful information is when there is a properly prepared portafilter, filled with properly ground and tamped coffee, locked in the grouphead, and the brewing process is underway. At all other times, even when the pump is refilling the boiler this gauge is not displaying any useful information and should be ignored. Even when the pull is underway the brew gauge will read a little higher than the actual brew pressure at the coffee.

If the pressure gauge is reading a very low pressure during a pull, the first thing to suspect is the coffee. The problem could be:

- not enough coffee in the portafilter
- coffee not properly distributed before tamping
- coffee not tamped properly or evenly
- coffee ground too coarse

If the pressure gauge is reading a high pressure during a pull it is almost always a matter of a poorly adjusted over pressure relief valve. The indicated brew pressure during a pull should never indicate more than about 9.5 to 10 BAR.

If after attempts to resolve a pressure related problem by adjusting the above factors have failed it is time to try adjustment of the pressure regulator. Do not attempt to adjust the valve by means other than described as above.

Pressurestat Adjustment



The pressurestat controls the brewing temperature by sensing the pressure in the boiler. If the pressure is too high the brewing temperature will be too high and the coffee can taste burnt or bitter. It can also cause excessive steam in the heat exchanger which contributes to the over-extraction and can create so much force that the steam can blast through the puck and cause a fast flow. On the other hand, if the pressure is too low, the brew temperature will be too low. The coffee will taste sour, under-extracted, and thin. Of course, these can be experienced through a whole range of tastes, and incorrect brewing temperature may not always be the cause of bad taste, bitter or sour.

Accessing the pressurestat adjustment is simple. Simply remove the cup warming tray and beneath that you will see a perforated panel with a black plug. Remove the plug and the adjustment screw will be seen underneath as shown here. Turn the screw to adjust the boiler temperature:

CLOCKWISE LOWERS the TEMPERATURE
COUNTERCLOCKWISE RAISES the TEMPERATURE

This adjustment is not very sensitive, so even a full turn of the screw is a fine adjustment, and that's a good thing because the generally accepted range is between .9 and 1.1 BAR. Still, it is important to make changes slowly and in small increments. Temperature of the brew water is a critical component of good espresso, and a change of one degree in the brewing temperature can make a big difference in the taste of the coffee.

In actual operation the function of pressurestat will create what is referred to as a "deadband." That is the range of temperature fluctuation caused the lag in time between when the heating element is energized to the time it turns it off. The deadband of the Vibiemme Domobars is about .15 BAR. So if you set the pressurestat for about 1 BAR, the gauge indicating boiler pressure might range from about .9 to 1.1. This is normal operation for all machines with pressurestats and is a function of the pressurestat design. To hold a smaller range of temperature the pressurestat would be clicking on and off every two or three seconds and would rapidly burn its contacts.



17 - Troubleshooting

-The machine is not working.

- Be sure it is plugged in and the circuit is working. Try another outlet if in doubt.
- Be sure the Power Switch is turned to Position I or Position II.

-No water can be pumped.

- Check the Low Water Level Warning Light to see if the reservoir needs to be refilled.
 - Check the water reservoir to be sure that the tank is properly seated in the machine. Lift it and set it back into place. You should be able to feel it compress the springs of its platform which engage the safety switch.
 - Be sure the Power Switch is turned to Position I or Position II.

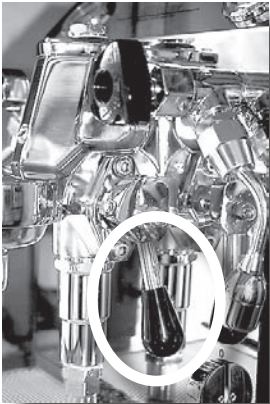

-The grouphead is not getting very warm

- The operating lever on the right side of the grouphead of the manual model must be in the fully-down position, pushed back towards the face of the machine as far as it will go (light pressure is all that is necessary- no need to force the lever). If it is not in this position, the water path for the thermosyphon is restricted and the grouphead will not reach the proper operating temperature.

- Be sure the Power Switch is turned to Position II.

- Check the Low Water Level Warning Light to see if the reservoir needs to be refilled.

-I can pump water, but the water is always cold.

- Check the power switch to be sure that it is in position II.
- Over Temperature Safety Thermostat tripped. This occurs if the pressurestat malfunctions or the water level is not maintained in the boiler. In either case the boiler can overheat. To save the machine from damage there is an over-temperature thermostat that protects the machine much like a circuit breaker or fuse protects the wiring in your home. And much in the same way as a circuit breaker, the over-temperature thermostat can be reset. If you suspect that the thermostat has been tripped it is important to verify the cause before continuing.

To reset the machine follow these instructions:

CAUTION: follow these instructions carefully.

Heat and electrical dangers are present inside the machine!

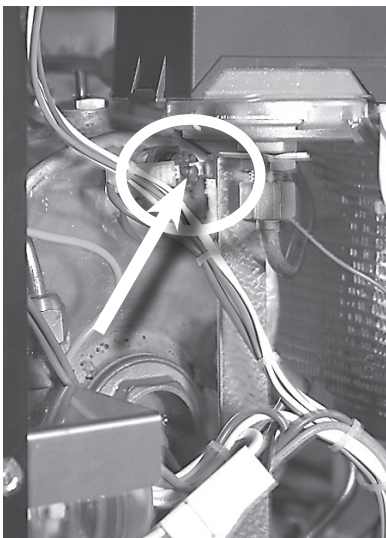

- 1) Turn the power switch to the off position
- 2) Disconnect the machine from power
- 3) Allow the machine to cool off to room temperature. This could take a few hours.
- 4) Remove the top cup warmer
- 5) Remove the 6 Phillips head screws on the rear cover and slide it off the machine.



- 6) The boiler is the large copper cylinder. On the right end of the boiler (when facing the front of the machine) near the top of the boiler you will find a small, black device with two wires connected to it. On the face of that device is a small, red button. Press the button. It should click back into position.

- 7) Replace the rear case being that the water reservoir and hoses are properly located. Replace and tighten the 6 Phillips head screws.
- 8) Replace the top cover
- 9) Plug the machine back into the power outlet.
- 10) Turn the switch to position I
- 11) After the pump stops turn the power switch to position II

If the thermostat trips again, please contact our service department.

-The Machine Stopped Suddenly in the Middle of a Pull

- Check the water level in the reservoir.

-The Coffee Tastes Bad

The list of causes is nearly endless. Volumes can be written on what can cause espresso to taste bad. Here are a few tips to help:

- Be sure that the coffee you are using is fresh
- Try a different brand of coffee.
- Are you using a quality grinder and grind the beans fresh for each use?
- If you know someone who makes espresso, invite them over and let them try making espresso with your equipment and coffee. Sometimes the smallest change in procedure can make a big difference in taste.

Bitter coffee can come from:

- Water that is too hot
- Coffee that is over-roasted or stale
- Cheap, low-quality coffee
- Worn burrs or low-quality grinder that makes too much dust
- Brew pressure that is too high
- Not using enough coffee in the portafilter.

Sour tastes can come from:

- Brewing temperature that is too cold
- Coffee that is under roasted
- Brew pressure that is too low
- Bad or spoiled coffee

-The brew pressure gauge acts erratically

The brew pressure gauge on the front panel should only be used as a general indicator as to what is happening during the brewing cycle. The only time when the gauge will display any useful information is when there is a properly prepared portafilter, filled with properly ground and tamped coffee, locked in the grouphead, and the brewing process is underway. At all other times, even when the pump is refilling the boiler, this gauge is not displaying any useful information and should be ignored. Even when the pull is underway the brew gauge will read a little higher than the actual brew pressure at the coffee. If all is going well, the gauge should read about 9.5 to 10 BAR during most of the pull.



1st-line

e q u i p m e n t

espresso and cappuccino specialists

espresso machine sales

8 8 8 - 9 3 3 - 5 9 4 7

monday-friday 10am-6pm est

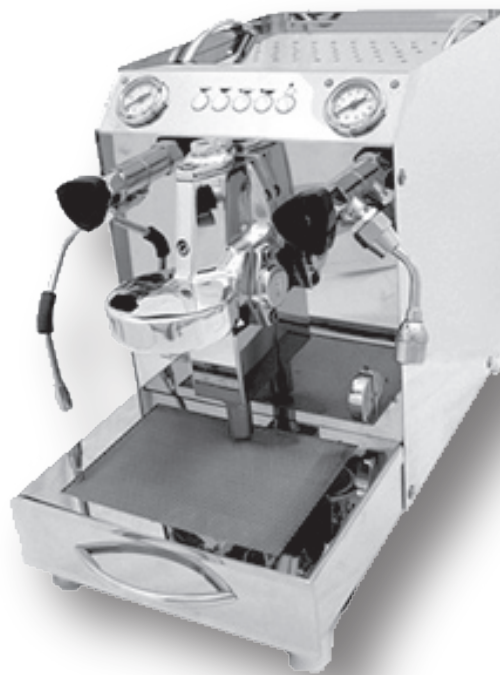

1st-line - WWW.1st-line.COM

Manual provided by 1st-line Equipment, LLC on an 'as-is' basis.