

LEVR UP™

CANOPY

SET-UP GUIDE

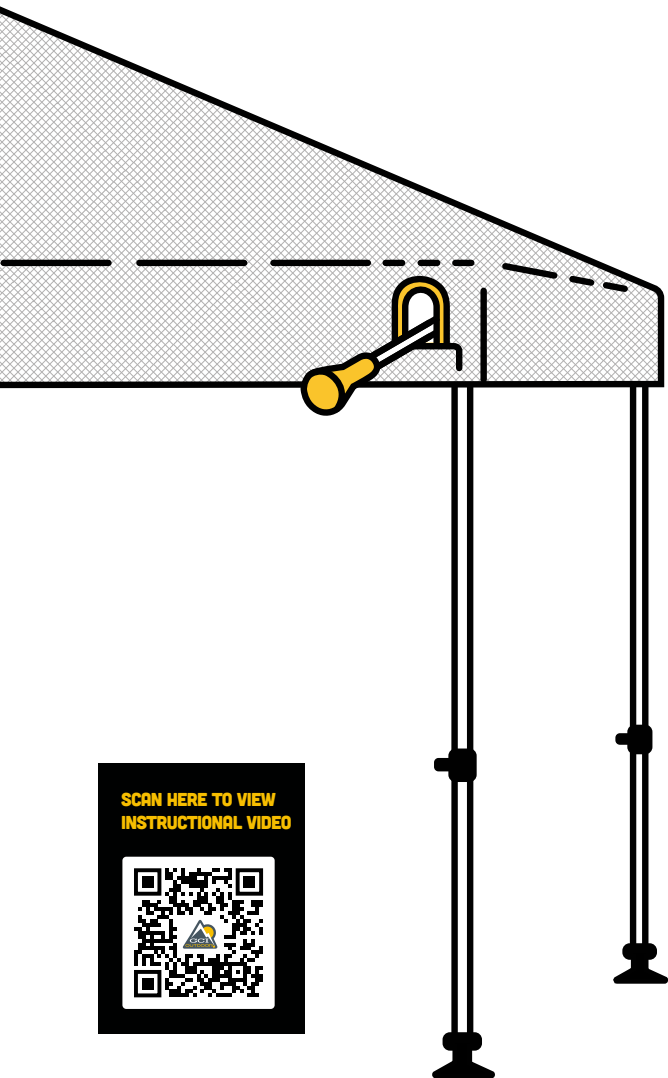

SCAN HERE TO VIEW INSTRUCTIONAL VIDEO



LEVRUP PARTS LIST

- (A) Frame
- (B) Canopy
- (C) LevrUp Handle
- (D) Frame Side X's
- (E) QR Code to Instructions
- (F) Strap
- (G) Center Lock Tube
- (H) Hook
- (I) Corner Lock Button
- (J) Roller Bag

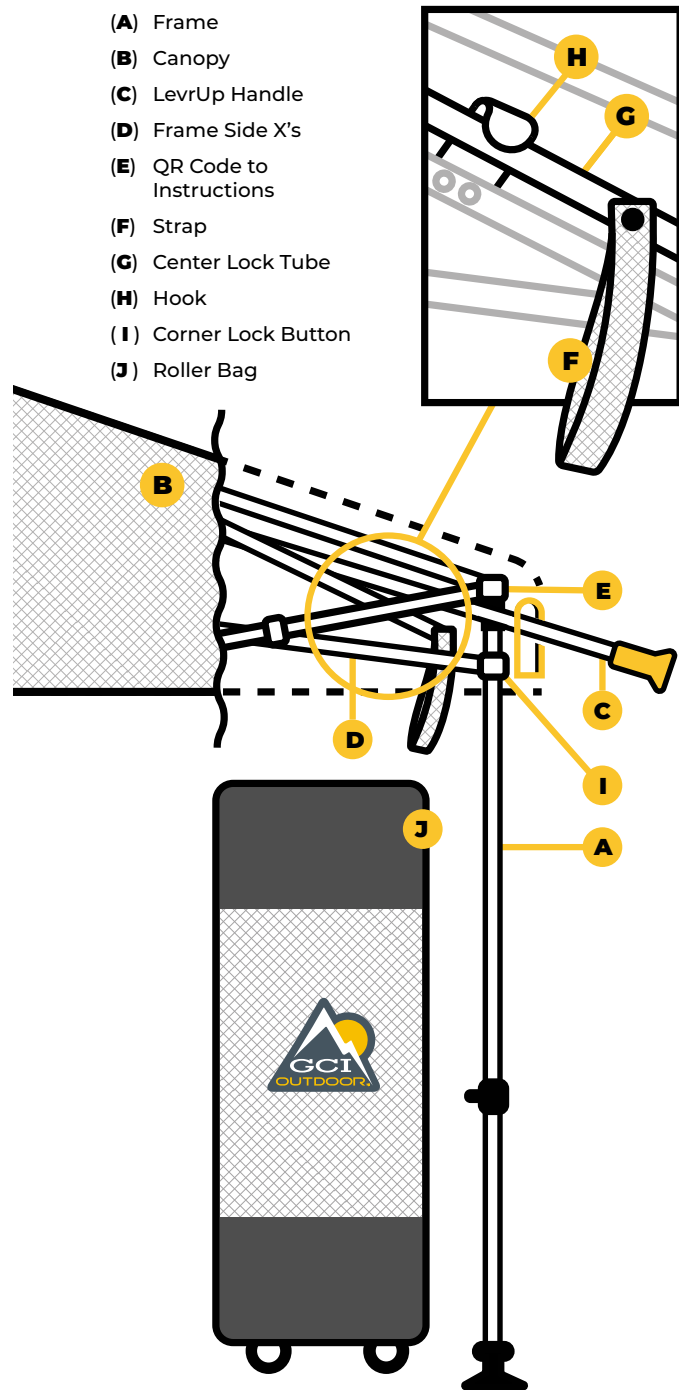

START HERE

IMPORTANT:

Read all instructions before proceeding. It is the user's responsibility to always take the following precautions.

- Select a level site clear of overhead power lines, rocks, branches, and other hard or sharp objects.
- Always stake down your shelter.
- Do not leave up for extended periods of time.
- Use caution when setting up and breaking down to avoid pinching hands or fingers.
- Do not use in severe weather.
- **WARNING: KEEP ALL FLAME AND HEAT SOURCES AWAY FROM THIS TENT FABRIC.**

This tent meets the flammability requirements of CPAI-84. The fabric may burn if left in continuous contact with any flame source. The application of any foreign substance to the tent fabric may render the flame-resistant properties ineffective.

CARE & MAINTENANCE

For long lasting durability and the best possible protection follow these care and maintenance instructions.

- To clean the canopy, use a mild soap (not detergent) and water.
- Let the LevrUp Canopy and frame dry completely before closing or storing to avoid mildew.
- Frame will operate and look better if occasionally wiped with silicone spray, especially before and after use in damp conditions. Remove excess silicone residue before attaching canopy to the frame.
- Use a seam sealer if top leaks or drips water. Available at most sporting goods and hardware stores.
- Slightly tighten bolts if frame becomes loose.



REGISTER

TO REGISTER YOUR PRODUCT, PLEASE SCAN THIS QR CODE.



WARRANTY

FOR WARRANTY INFORMATION, AND TO SUBMIT A CLAIM, PLEASE SCAN THIS QR CODE.

QUESTIONS? EMAIL INFO@GCIOUTDOOR.COM OR CALL 800.956.7328.

STEP 1:

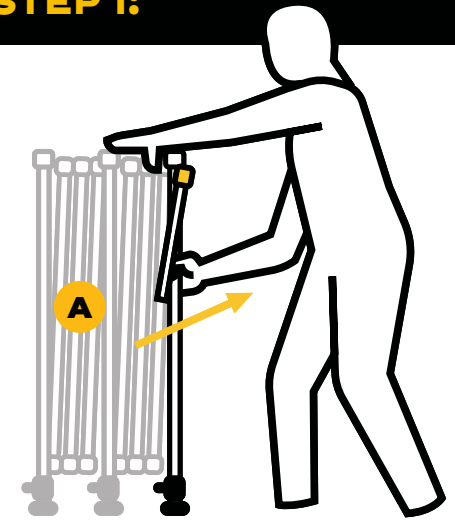

LIFT & EXPAND

Stand the Frame (A) upright on a level surface. Lift the leg at the LevrUp corner slightly off the ground and gently pull outward, expanding the frame about 2/3 open.

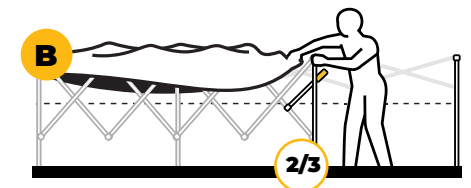

Place the Canopy (B) on top of the Frame and attach all corners, except for the LevrUp corner, using the attached hook-and-loop to fasten.

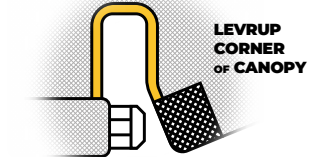

LEVRUP CORNER OF CANOPY

ATTENTION - Leave the corner of Canopy at the LevrUp handle off until after completing Step 3.

STEP 2:

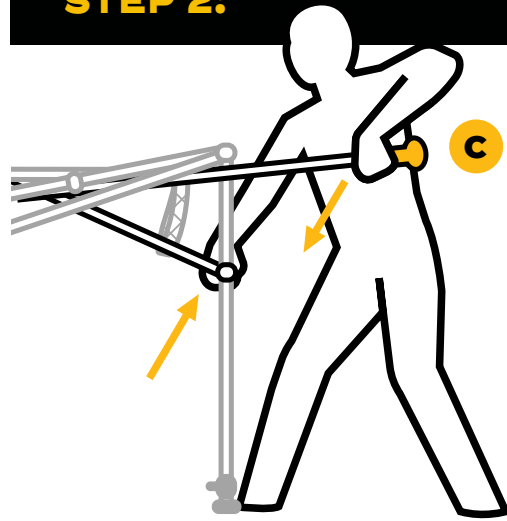

LEVRUP

Extend the LevrUp Handle (C) outward from the frame, then simultaneously push the LevrUp Handle (C) down toward the Frame Side X (D), while pulling Frame Side X up toward LevrUp Handle until the corner locks into place. You will hear a click when this has been engaged.

TIP - Slightly lift the leg at the LevrUp corner off the ground to complete this step.

TIP - The Frame Side X's can be grabbed from either side of the LevrUp corner, depending on right or left-handed preference.

STEP 3:

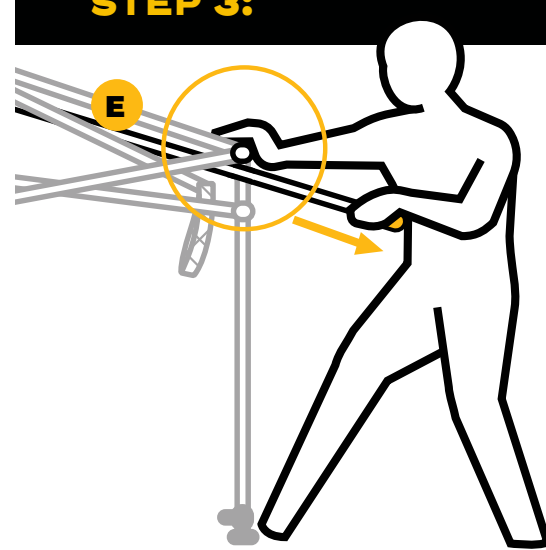

LOCK ROOF

Simultaneously brace one hand above the QR Code to Instructions (E), while pulling LevrUp Handle outward with the other hand.

Now attach the final corner of the Canopy at the LevrUp corner.

With all 4 corners of the Canopy attached, hook the end of the Canopy bungees to the bottom of the "V"s formed by the Frame Side X's.

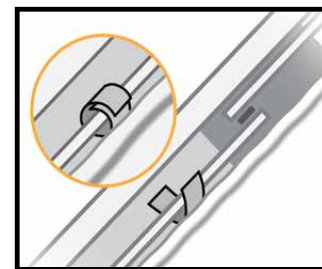
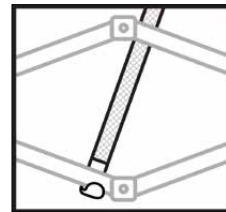

Wrap the strip of hook and loop attached to the underside of the Canopy fabric around the Frame tube that reads, "Wrap Hook and Loop Here".

OPTIONAL:

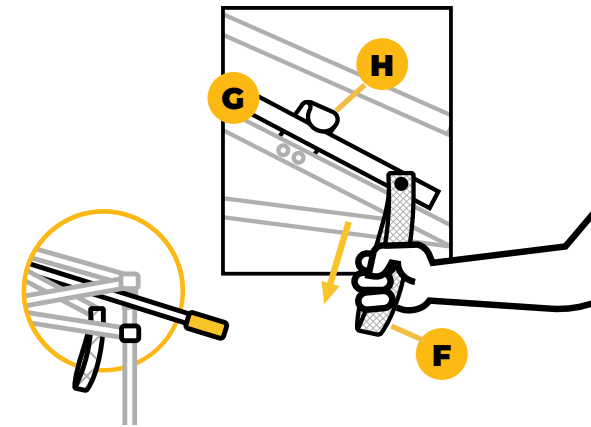

ALWAYS REMEMBER

If you intend to hang anything from the Frame (under the Canopy) pull down on the Strap (F) and engage the Center Lock Tube (G) into hook (H).

TIP - The Canopy can be left on frame, prior to storing in the Roller Bag.

NOTE - For instructions on disassembly, see back panel.

CLOSE & STORE:

1. DISENGAGE CENTER LOCK

If engaged, disengage Center Lock Tube (G). This is the reverse of optional step noted during set-up.

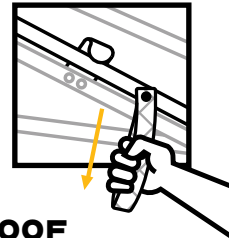

2. UNLOCK FRAME & ROOF

Simultaneously push LevrUp Handle inward with a "hard tap", while pressing the Corner Lock Button (I) to unlock roof and frame.

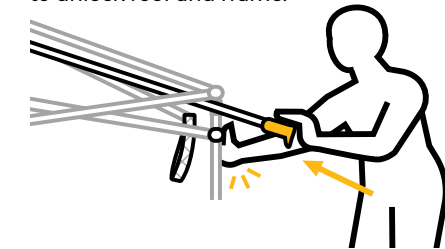

3. PUSH IN TO COLLAPSE

Push the LevrUp Frame and Canopy inward from one corner to fully collapse for storage in Roller Bag (J).

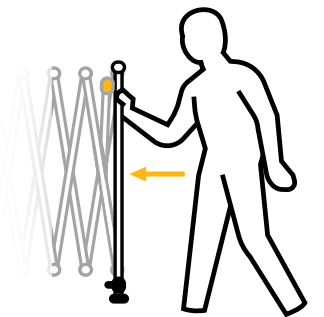

ATTENTION - Let the LevrUp Canopy and Frame dry completely before closing or storing to avoid mildew.



GCI OUTDOOR
457 KILLINGWORTH RD.
HIGGANUM, CT 06441

800.956.7328
860.345.9595
GCIOUTDOOR.COM