

# Product manual

Product range

Residential outdoor

Product type

Outdoor sauna

Model

Garda

## 1. General information

Driven by simplicity and functionality, Garda is a premanufactured, compact and modular outdoor sauna for residential use. Available in two layouts and 2 exterior finishes, interior of highest quality thermo aspen, equipped with Auroom design heater that fits interior seamlessly. Spacious interior, sturdy construction.

## 2. Technical specification

FEATURE		
Exterior finish	Thermopine C7	Translucent white
Width	2232mm	2188mm
Depth	2232mm	2188mm
Height	2530 mm	
Weight	Approx 1800 kg	
Interior finish	Thermo Aspen	
Construction	70mm 3-ply CLT	
Layouts	Rear window or side window	
Seats	4 - 6 people	
Power supply	3P 400V 50Hz	
Heater and control	Auroom/Huum Core 10,5 kW, UKU Glass controller	
Lights	LED underbench lights	
Doors and windows	Aluminium frame, tempered glass	

### 3. Intended use

Garda is a semi-independent product, needs power supply for the heater. Intended to be used as dry finnish type sauna. Any other use of the product other than manufacturer's specified use, is prohibited as it may result in unforeseen damages to the product or health and property.

### 4. Construction

Garda's construction is of CLT panels (cross laminated timber). CLT is a novel massive wood product, renowned for it's exceptional stability and rigidity as well as sustainability.

### 5. Layouts

Depending on direction of desired view, Garda offers two layouts, both favoring social interaction:

- Rear window - opposite benches
- Side window - L configuration benches

### 6. Interior

Interior is finished in top quality thermo aspen panels and boards. Floor is covered with waterproof PVC and covered with thermo aspen floor grids.

### 7. Exterior

Two exterior finish options:

- thermo pine cladding C7 gives Garda a premium modern finish
- translucent white is simplistic, CLT is painted with translucent white paint leaves natural wood pattern underneath shimmering through for a natural finish

## 8. Transport and lifting

Garda is modular and transported in one piece. It can be lifted by forklift or hoisted by a crane. When lifting or hoisting always follow signs on packaging, precautions provided by producer and general safety protocols.

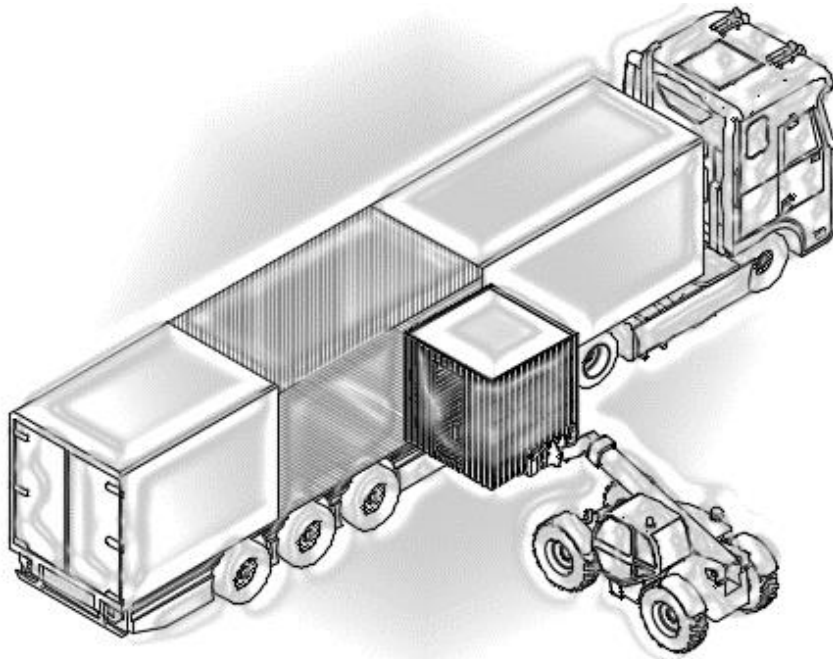

*Lifting by forklift*

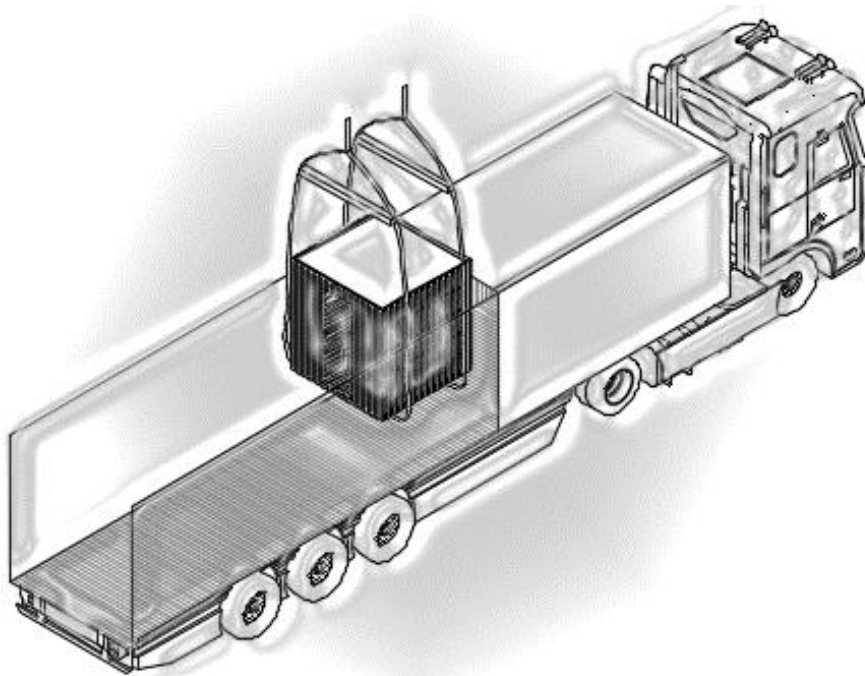

*Hoisting by crane*

## 9. Installation

Product must be installed on previously prepared stable and level substructure. Producer recommends a concrete slab or other substructures provided they fulfil aforementioned requirements. This ensures the product performs as intended.

Installation site must have access to power supply. Sauna is connected to power via power socket on exterior wall.

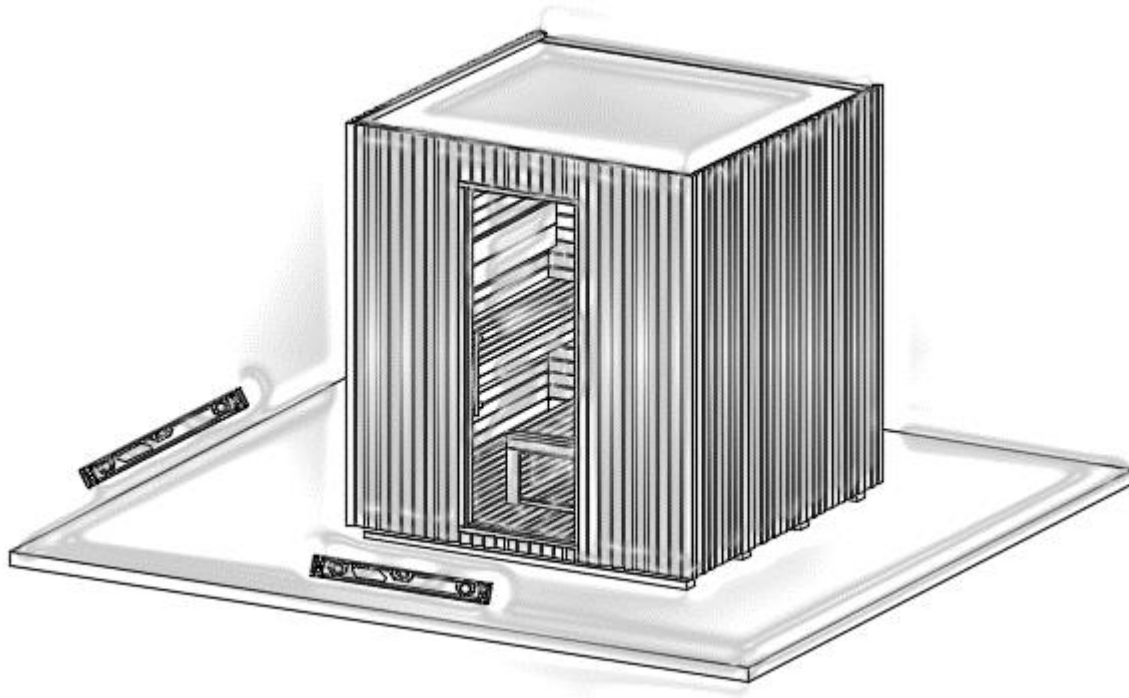

*Checking the level of substructure*

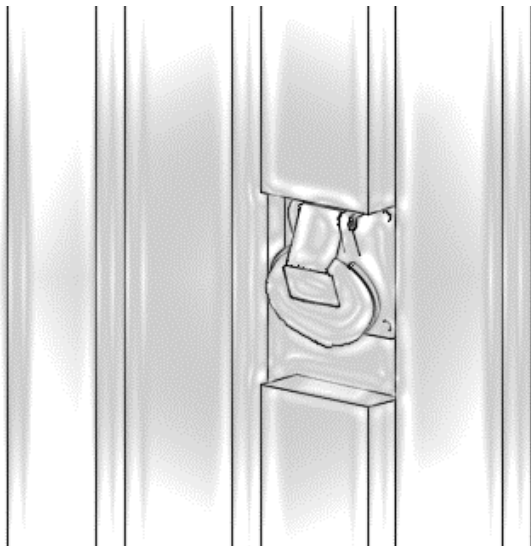

*Power socket on wall*