

BATHOLOGY

rediscover bathing



Atmospheric 330







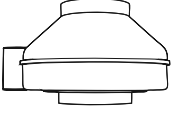

Bath Ventilation

Installation and Operation Manual



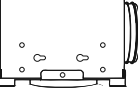

Components

Spec Page Install Page



Fan Kit

Fan		Expansion Vent		Spec Page	Install Page	
A		1x 190 CFM Exhaust Fan, 6"		4x 1" Screws	6	6 - 8
		1x Mounting Bracket		4x 7/16" Screws		
B		1x Expansion Vent Housing, 6" duct		4x Hanger Bars	9	9 - 10
		1x Expansion Vent Grille		4x 1" Screws		
				2x 3/8" Short Screws		

Electronic Time Control

C		1x Electronic Time Control		1x Timer Face (White) (Pre-installed)	11	11 - 13
		2x Mounting Screws		1x Timer Face (Ivory)		
				1x Timer Face (Almond)		

Damper

E		1x Damper, 6"		3x Damper Screws	14	14
---	---	---------------	---	------------------	----	----

Duct



H		1x Flex Duct, 6"x25'			16	16 - 17
---	---	----------------------	--	--	----	---------

Mastic and Duct Ties

I		1x Mastic Tube Net Contents: 1/12 Gallon		8x Flex Duct Tie, 18"	16	16 - 17
---	---	---	---	-----------------------	----	---------

Components Continued

Optional

Slide Speed Control								
D		1x	Slide Speed Control		2x	Mounting Screws	11	11 - 13
					3x	Wire Nuts		

Vent Options

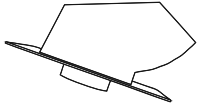
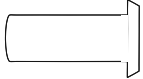
Roof Cap							
F		1x	Roof Cap, 6"			15	15
Wall Vent							
G		1x	Wall Vent, 6"			15	15

Typical Installation - Exterior Roof

Important: It is recommended that all electrical equipment be tested prior to installation.

Page	ID	Product
6 - 8	A	Fan
9 - 10	B	Expansion Vent
11 - 13	C	Electronic Timer Control
11 - 13	D	Speed Slide Control
14	E	Damper
15	F	Roof Cap
16 - 17	H	Duct
16 - 17	I	Mastic and Ties

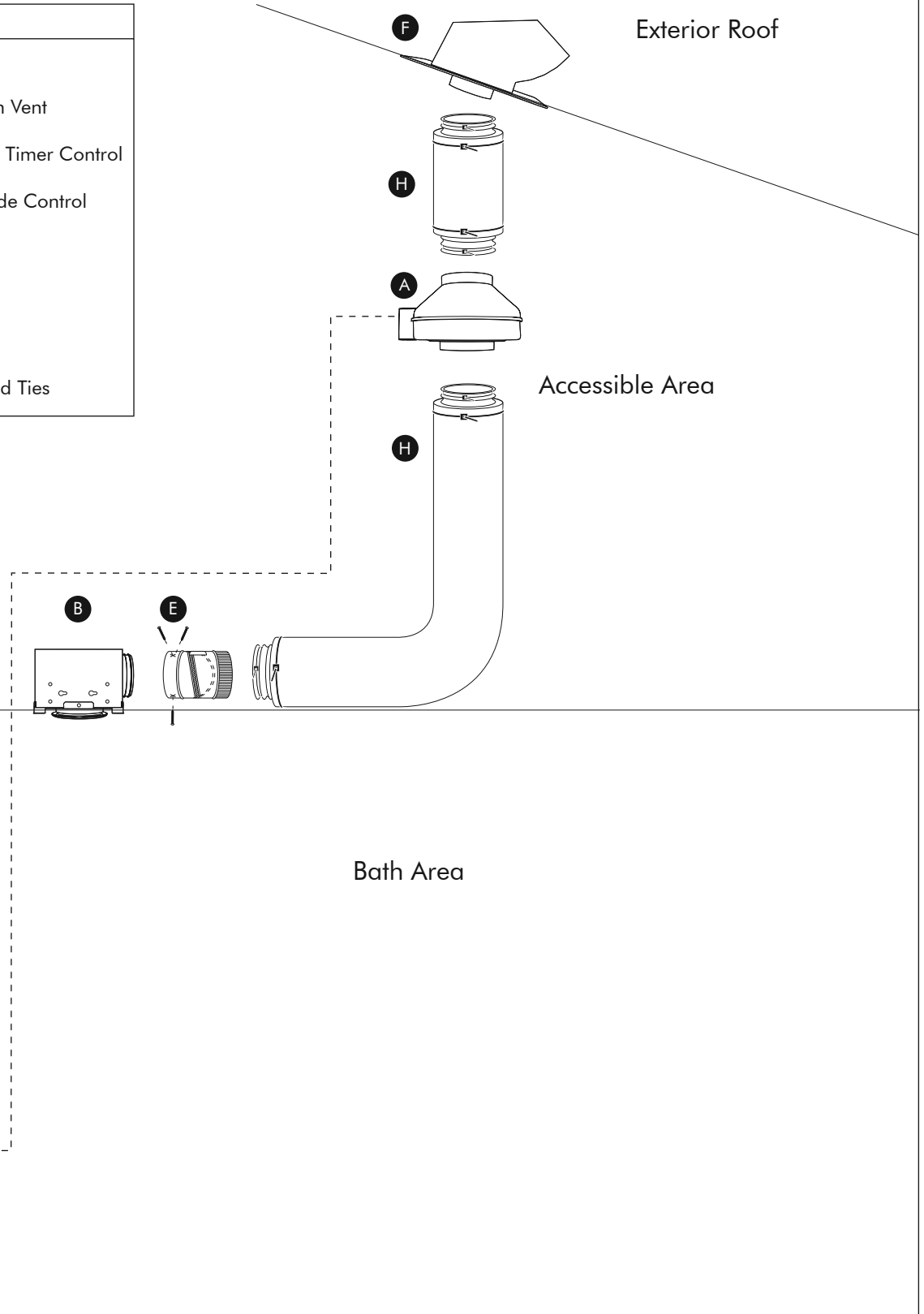

Typical Installation - Exterior Wall

Important: It is recommended that all electrical equipment be tested prior to installation.

Page	ID	Product
6 - 8	A	Fan
9 - 10	B	Expansion Vent
11 - 13	C	Electronic Timer Control
11 - 13	D	Speed Slide Control
14	E	Damper
15	G	Wall Vent
16 - 17	H	Duct
16 - 17	I	Mastic and Ties

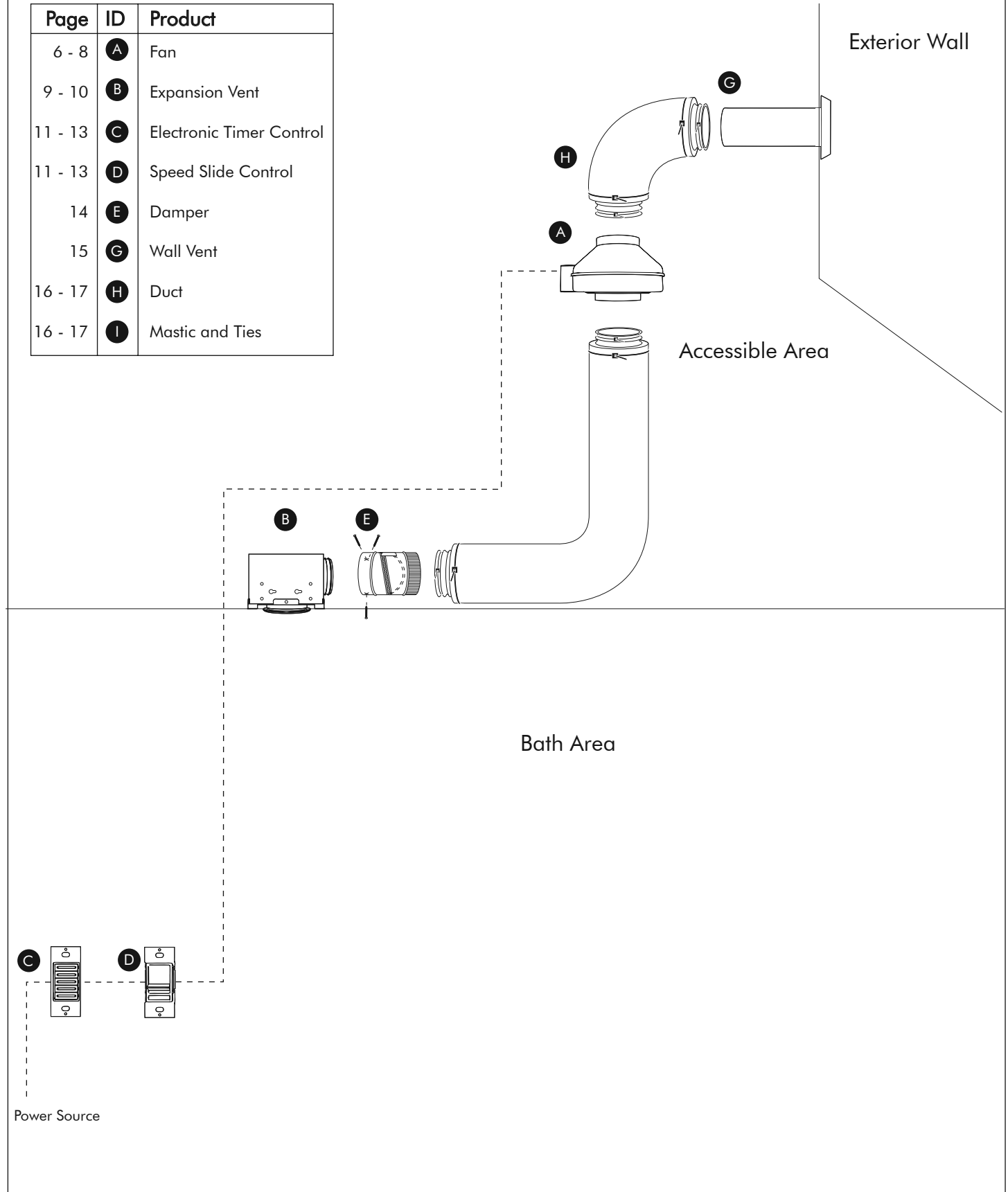

Fan Specifications and Installation

Specifications

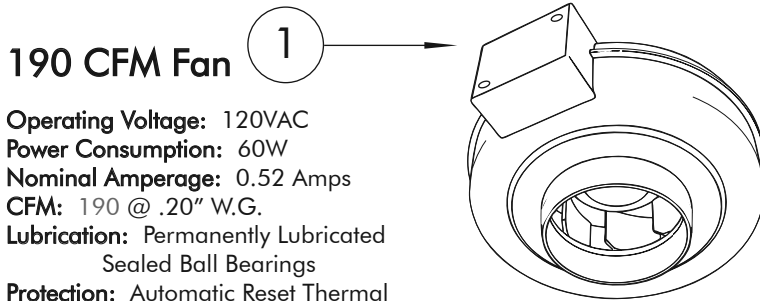

- Operating Voltage:** 120VAC
- Power Consumption:** 60W
- Nominal Amperage:** 0.52 Amps
- CFM:** 190 @ .20" W.G.
- Lubrication:** Permanently Lubricated Sealed Ball Bearings
- Protection:** Automatic Reset Thermal Overload Protection
- Speed Control:** 100% Speed Controllable
- Testing:** U.L. Listed; CSA Certified
- Airstream Tolerance:** Suitable for Airstream Temperatures up to 140°F
- Dimensions:** 11-3/8" Diameter x 8" Length

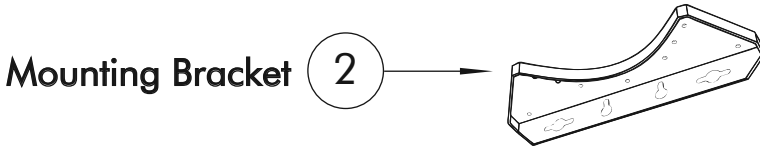

Installation

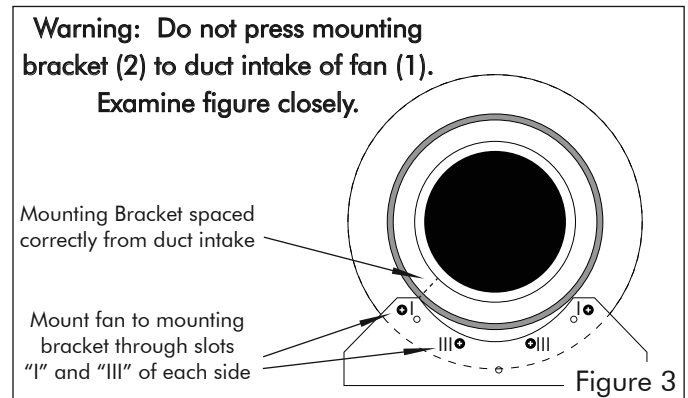
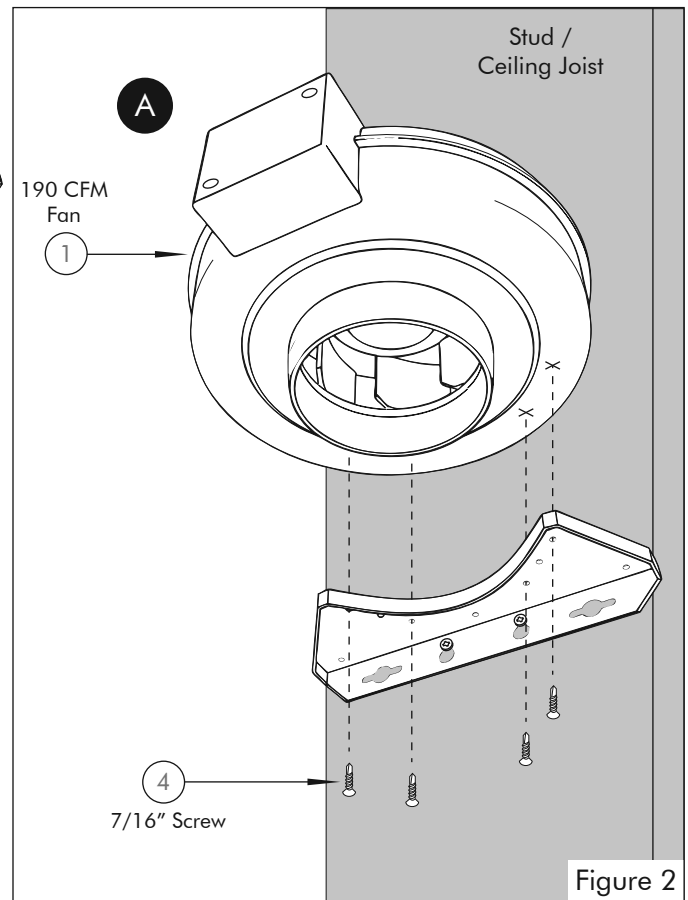
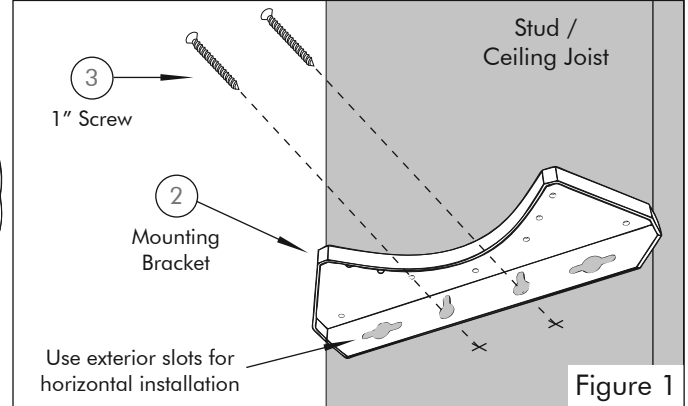

Fan Installation

Installation Considerations

- **Warning:** For your safety, read and understand instructions completely before starting. Before wiring to power supply, turn off electricity at the fuse or circuit breaker box. Make sure electrical service to fan is locked in "OFF" position.
- **Note:** Prior to installation, consider the placement of the 190 CFM Fan carefully, taking into account the location of electrical, plumbing, and other fixtures.
- **Note:** All units are suitable for use with solid-state speed controls
- **Note:** This unit has rotating parts and safety precautions should be exercised during installation, operation and maintenance.
- **Caution:** For general ventilation use only. Do not use to exhaust hazardous or explosive materials and vapors.
- **Note:** All wiring must be done in accordance with National Electrical Code and local building code.
- **Note:** The combustion air-flow needed for safe operation of fuel burning equipment may be affected by this unit's operation. Follow the heating equipment manufacturer's guidelines and safety standards such as those published by the National Fire Protection Association (NFPA), the American Society of Heating, Refrigeration, and Air Conditioning Engineers (ASHRAE).
- **Note:** Exhaust fans must always be vented to the outdoors.
- **Note:** Acceptable for use over a bathtub or shower.
- **Warning:** NEVER place a switch where it can be reached from a tub or shower.
- **Warning:** For installation over a tub or shower, power source must be externally switched GFCI circuit and must be installed in accordance with local and building codes.

- **Warning:** Check voltage at the fan to see if it corresponds to the motor nameplate.
- **Warning:** Guards must be installed when fan is within reach of personnel or within seven (7) feet of working level or when deemed advisable for safety.

CAUTION For safety purposes, use safety goggles at all times.

WARNING Before wiring to power supply, turn off electricity at the fuse or circuit breaker box.

WARNING Check for piping/electrical before cutting or drilling.

WARNING If there is any risk of uninsulated electrical connections in your wall/ceiling area, use insulating gloves.

Important: It is recommended that all electrical equipment be tested prior to installation.

Installation

1. When selecting fan (1) mounting location, the following criteria should be considered: a) mounting to minimize noise generated by fan operation; b) service accessibility.
 - a) Mounting to minimize noise generated by fan operation: Mounting the fan (1) as far as possible from the intake point will minimize fan operating noise from being transmitted back through the duct work. Insulated flexible type duct work (recommended for all bathroom exhaust applications) will result in much quieter operation. It is recommended that a minimum 8' of insulated flexible ducting be used between any expansion vent and fan (1) for low noise level.
 - b) Service accessibility: Fan (1) location should allow sufficient access for service.

Fan Installation

- Using the 1" wood screws (3) provided, attach the fan mounting bracket (2) to a support beam at the selected location (see figure 1 on page 6). **Note:** Fan (1) mounting can be at any point along the duct and in any angle; however, vertical mounting is recommended to reduce condensation buildup in the fan (1). If a horizontal installation is necessary and condensation buildup may pose a problem, wrap insulation around the fan (1).
- Attach fan (1) to the mounting bracket (2) with the four 7/16" sheet metal screws (4) provided, making sure the wiring box is positioned for easy access (see figure 2 and 3 on page 6). **Note:** Screws are self tapping and do not require pilot holes. **Warning: Do not press mounting bracket (2) to duct intake of fan (1). Examine figure closely.**

- Secure the romex connector. Secure the incoming supply with the romex connector. Replace the fan terminal box cover. All fan motor and capacitor connections have been pre-wired from the factory. No additional fan wiring is necessary.

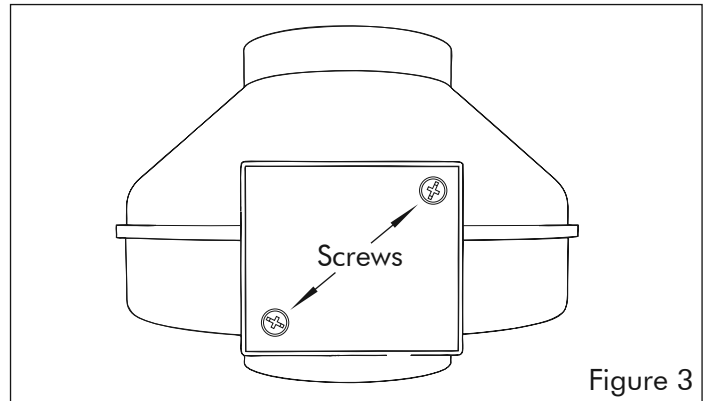

Figure 3

Wiring the Fan

- Remove the screws securing the terminal box cover plate located on the side of the fan (1) (see figure 3). All fan motor connections are pre-wired to an electrical terminal strip. A 3/8" romex type cable restraint connector will be needed to secure the wiring through the knockout provided on the side of the terminal box.
- Bring incoming electrical service through the romex connector and the fan knockout. Be sure to place the connector nut over the wiring coming into the terminal box. There are two open ports on the terminal strip. Using a small regular screwdriver, tighten the neutral (white) wire of the incoming supply under the open terminal strip port labeled "N". Tighten the line (black) wire of the incoming supply under the open terminal strip port labeled "L". Since the fan motor is isolated within a plastic housing, grounding is not necessary (see figure 4).

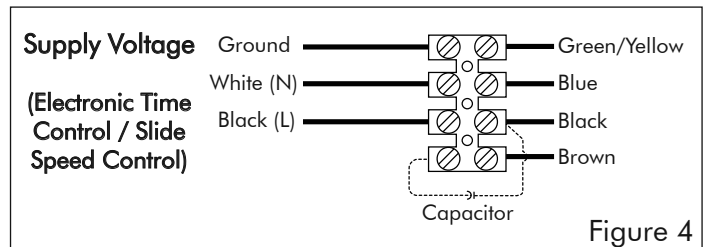
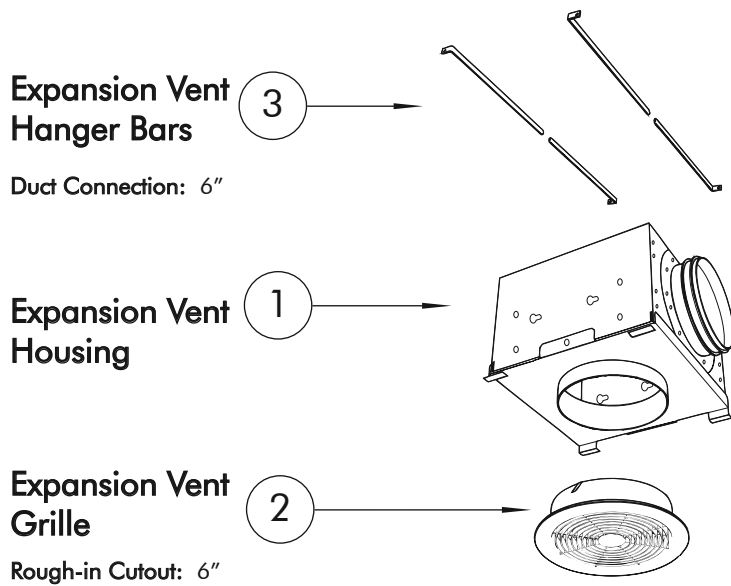

Figure 4

Housing Specifications and Installation

Specifications



Installation Considerations

- **Warning:** For your safety, read and understand instructions completely before starting.
- **Note:** Prior to installation, consider the placement of the Expansion Vent carefully, taking into account the location of electrical, plumbing, and other fixtures.
- **Note:** The combustion air-flow needed for safe operation of fuel burning equipment may be affected by this unit's operation. Follow the heating equipment manufacturer's guidelines and safety standards such as those published by the National Fire Protection Association (NFPA), the American Society of Heating, Refrigeration, and Air Conditioning Engineers (ASHRAE).
- **Note:** Exhaust fans must always be vented to the outdoors.

CAUTION For safety purposes, use safety goggles at all times.

WARNING Check for piping/electrical before cutting or drilling.

WARNING If there is any risk of uninsulated electrical connections in your wall/ceiling area, use insulating gloves.

Installation

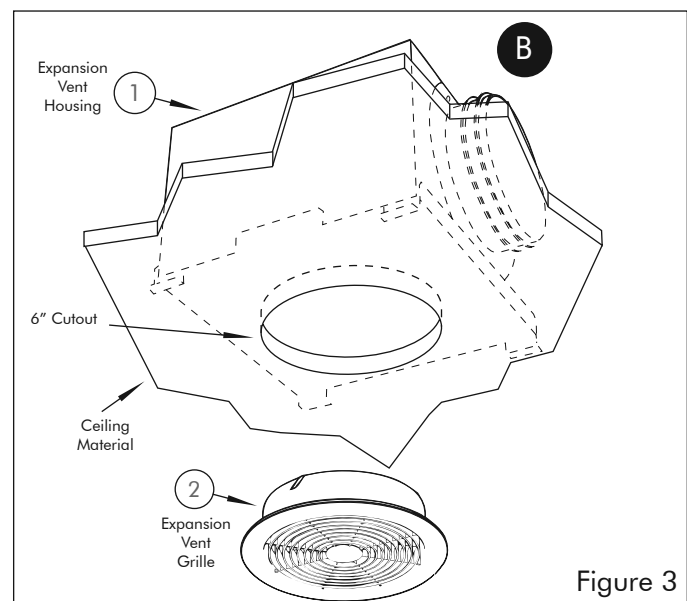
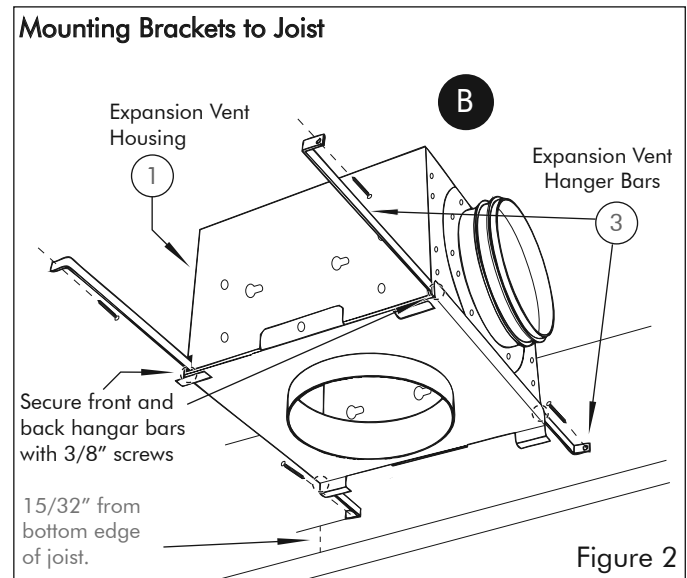
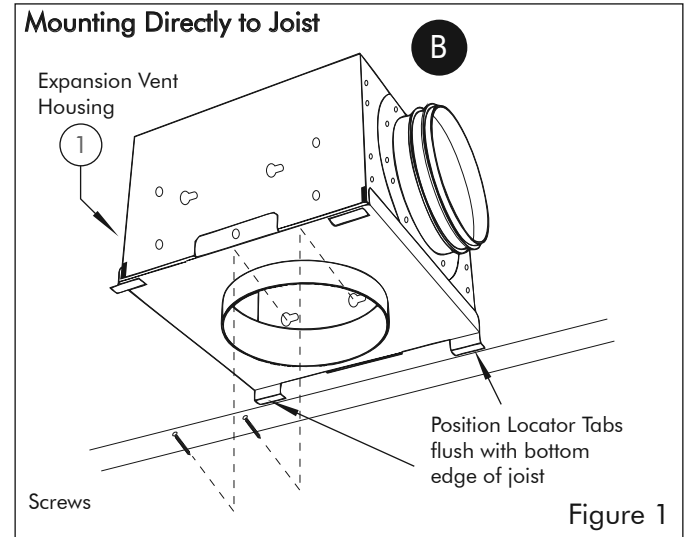

Expansion Ventilation Installation

Installation

1. Based on the bathroom layout and fixtures, plan the location of the expansion vent grilles (2) for the most effective ventilation.
2. Mount expansion vent housing (1) directly to the ceiling joist using screws and keyhole slots. Locator tabs on housing should be flush with the bottom edge of the ceiling joist for correct positioning of the unit once ceiling material is installed (see figure 1 on page 9).

OR

Use the expansion vent hanger bars (3) to suspend the expansion vent housing (1) between ceiling joists. For correct positioning, hanger bars (3) should be positioned $15/32$ " up from the bottom edge of the ceiling joist. Secure hanger bars with $3/8$ " screws (see figure 2 on page 9).

Note: Expansion vent hanger bars (3) can be used on ceiling joists up to 16" on center.

Note: If ceiling material is thicker than $5/8$ " the locator tabs may be removed to allow the grille collar to be flush with the finished ceiling material.

Note: Designed for 1-1/8" ceiling material maximum.

3. Cut a 6" round hole for the expansion vent grille (2).
4. Install the expansion vent grille (2) by pushing it firmly into the steel collar until it is shouldered by the ceiling material (see figure 3 on page 9).

Control Specifications and Installation

Specifications

Electronic Time Control

Operating Voltage: 120VAC, 60Hz
Nominal Amperage: 20 Amps
Motorload: 1HP

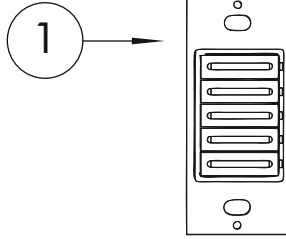

Optional Slide Speed Control

Operating Voltage: 120VAC, 60Hz
Nominal Amperage: 5 Amps

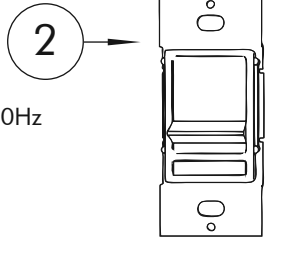

CAUTION For safety purposes, use safety goggles at all times.

WARNING Before wiring to power supply, turn off electricity at the fuse or circuit breaker box.

WARNING Check for piping/electrical before cutting or drilling.

WARNING Electrical components are not waterproof.

WARNING If there is any risk of uninsulated electrical connections in your wall/ceiling area, use insulating gloves.

Installation Considerations

- **Warning:** For your safety, read and understand instructions completely before starting. Before wiring to power supply, turn off electricity at the fuse or circuit breaker box.
- **Note:** All wiring must be done in accordance with National Electrical Code and local building code.
- **Note:** NEVER place a switch where it can be reached from a tub or shower.
- **Note:** Recommended minimum wall box depth is 2-1/2".
- **Note:** Maximum wire length from electronic time control to all installed remote switches cannot exceed 300 ft (90m).
- **Note:** Use these devices with copper or copper clad wire only.
- **Note:** When combinations of electronic time control / slide speed control are installed in a ganged wall or outlet box, derating is required. When two devices are mounted in a ganged box, the maximum load per device shall not exceed 4A or 500 watts. When three or more devices are mounted in a ganged box, the maximum load shall not exceed 3A or 400 watts.
- **Note:** The electronic time control and the slide speed control should be installed 48" above the floor, on a vertical wall, convenient for user operation.

Control Installation

Timer / Fan Wiring

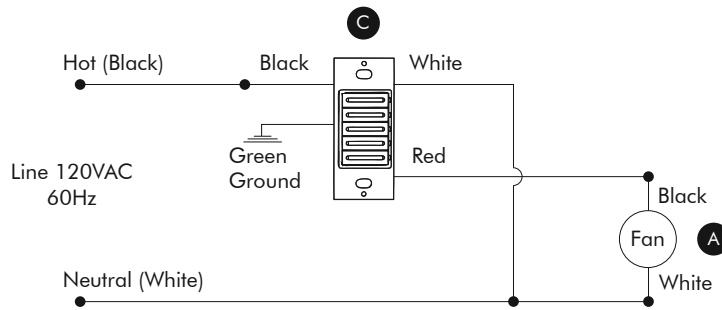

Timer / Light / Fan Wiring

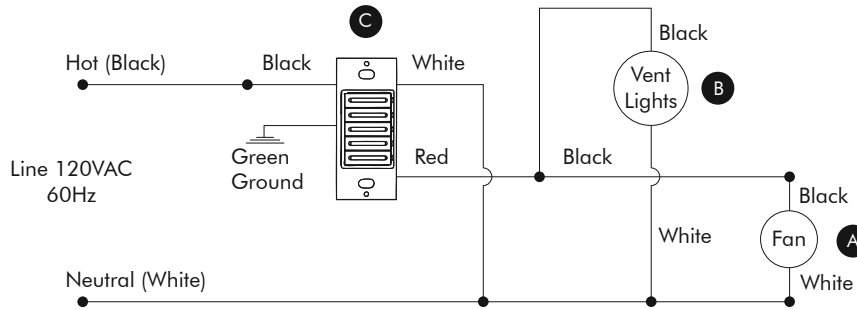

Timer / Slider / Fan Wiring

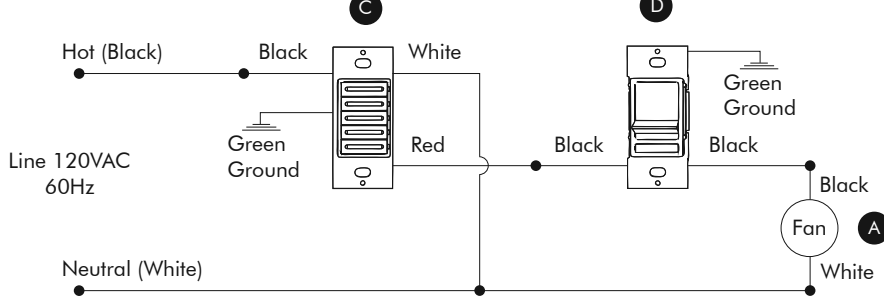

Timer / Lights / Slider / Fan Wiring

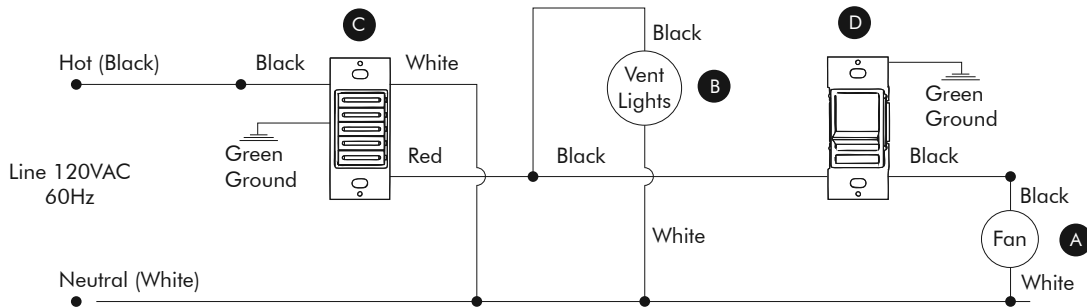

Control Installation

Important: It is recommended that all electrical equipment be tested prior to installation.

Installation

1. To change faceplate of electronic time control (1), push in the side of the faceplate at the tabs to release. With desired faceplate, line up tabs and press in sides one at a time to attach.
2. Remove pre-cut 3/8" of insulation from each circuit conductor. Make sure the ends of wires are straight.
3. Install electronic time control (1) and slide speed control (2) into double gang box, two single gang boxes, or single gang box as installation permits.
4. Connect wires per applicable wiring diagram on previous page: Twist strands of each lead tightly together and, with circuit conductors, push firmly into appropriate wire connector. Screw connectors on clockwise making sure no bare conductors show below the wire connectors. Secure each connector with electrical tape.
5. Restore power at circuit breaker or fuse.

Operation

Press timer button based on desired operation time. This will enable use of the slide speed control (B), as well as illuminate expansion vent lighting if present. Slide bar control up or down for desired fan rotation speed. ON/OFF rocker switch will turn fan ON at speed set by slide bar.

Damper Specifications / Installation

Specifications

Damper ①

- Dimensions:** 6" Diameter x 6" Length
- Body Composition:** 28 gauge galvanized steel
- Blade Composition:** Aluminum blades
- Gasket Composition:** Foam

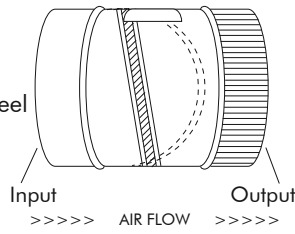

Damper Screw ②



Installation Considerations

Please read this manual in its entirety prior to installation.

- **Note:** Output end should never be lower than input.
- **Note:** Follow all applicable codes and standards.

Installation

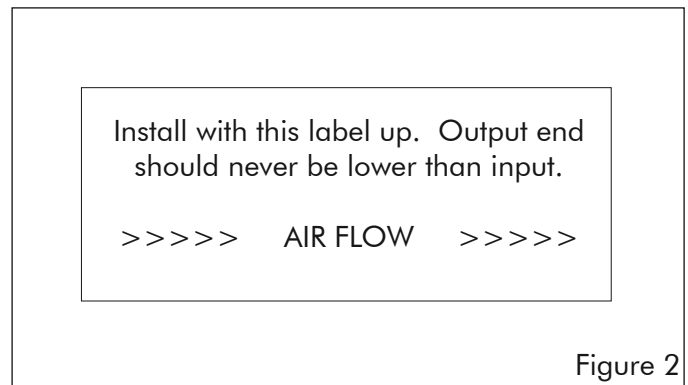
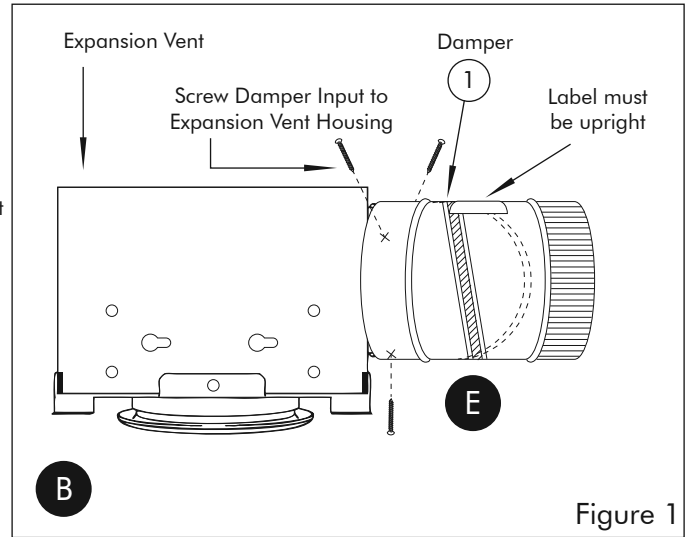

Roof Cap / Wall Vent Specifications and Installation

Specifications

Roof Cap, 6"

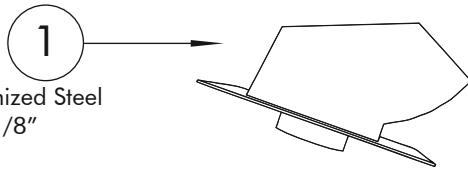

Composition: Galvanized Steel
 Rough-in Cutout: 6-1/8"
 Duct Connection: 6"
 Cap Dimensions: 10-3/4"L x 8-1/4"W x 5-1/4"H

Wall Vent, 6"

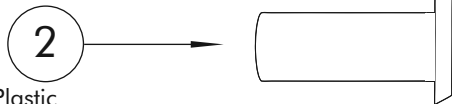

Grille Composition: Plastic
 Extension Composition: Galvanized Steel
 Rough-in Cutout: 6-1/8"
 Duct Connection: 6"
 Cap Dimensions: 8-1/8"L x 8-1/8"W x 7/16"H
 Duct Extension: 6" Diameter x 12" Length

Installation Considerations

Please read this manual in its entirety prior to installation.

- **Note:** Do not install the roof cap on a flat roof!
- **Note:** Follow all applicable codes and standards.

Installation

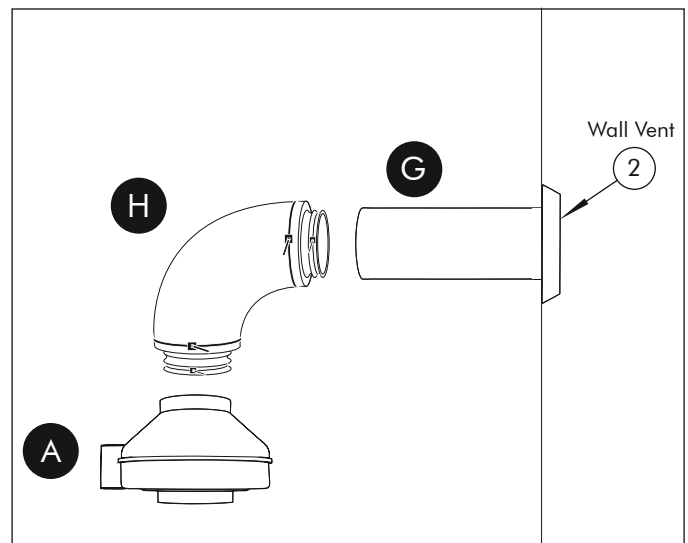
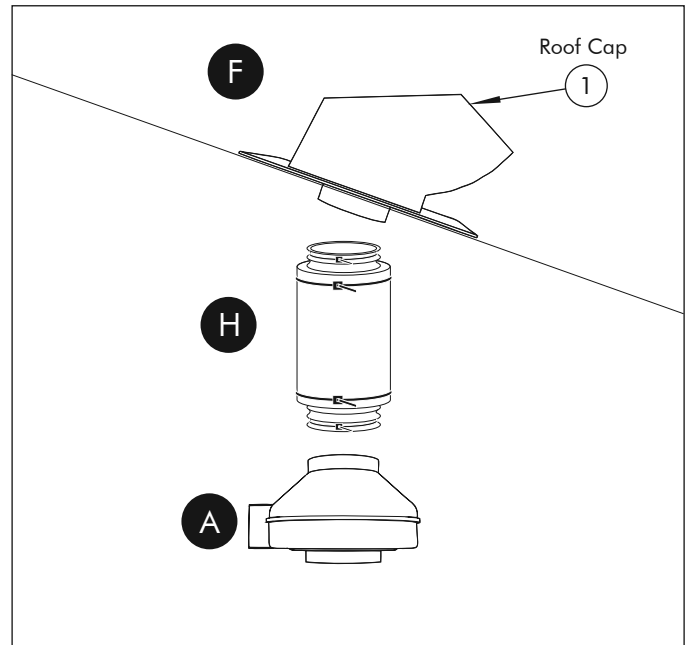

Duct Specifications and Installation

Specifications

Flex Duct, 6"



- Dimensions:** 6" Diameter x 25' Length
- Insulation:** Fiberglass
- Outer Cover:** Tri-directional, scrim reinforced grey polyester
- Testing:** U.L. Listed, Suitable for Wet Locations
- R-Value:** 4.2
- Rated Positive Pressure:** 10" w.g. per UL-181
- Maximum Positive:** 6" w.g.
- Maximum Negative:** 3/4" w.g.
- Maximum Velocity:** 5000 FPM
- Maximum Operating Temperatures:** -20°F to 140°F
Continuous (@ maximum pressure)

Flex Duct Tie, 36"

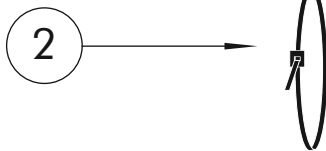

Compliance: UL-181-B

Mastic Tube

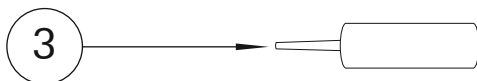

Compliance: UL-181-B
Net Contents: 1/12 Gallon

Installation

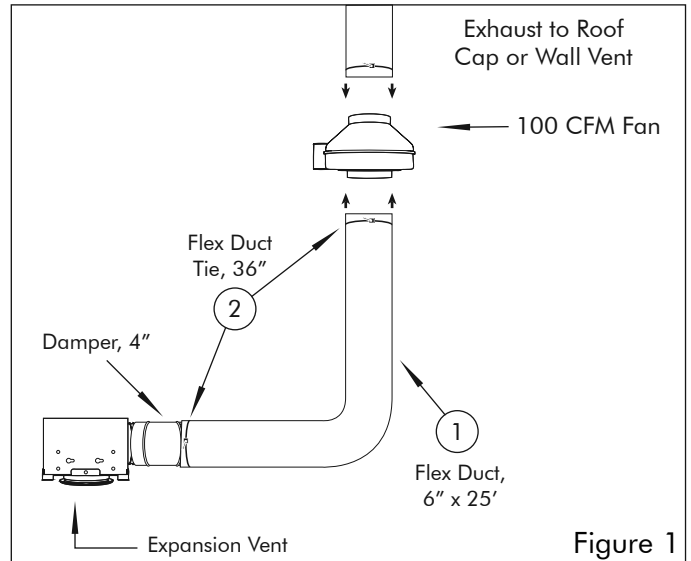

Figure 1

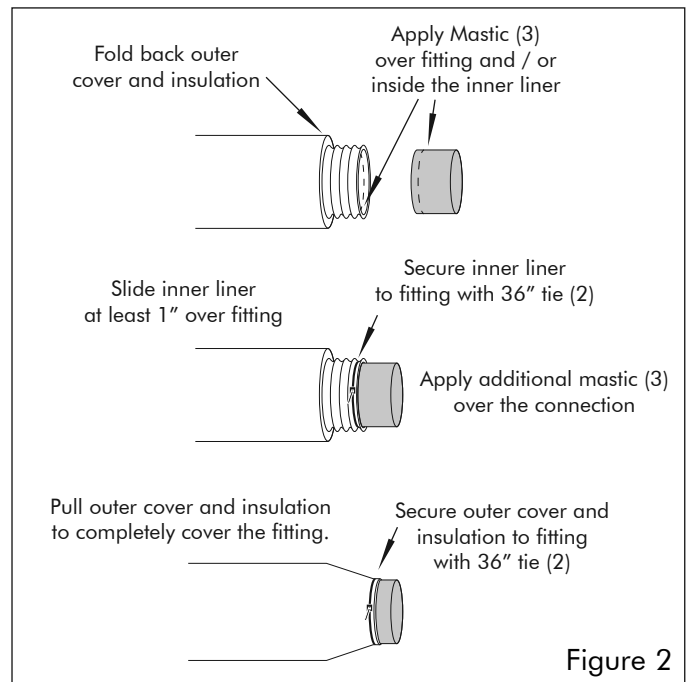

Figure 2

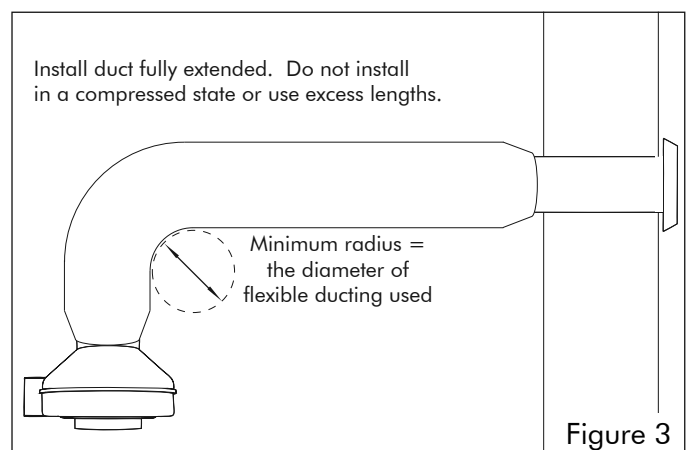

Figure 3

Duct Installation

Installation Considerations

Note: Do not use “outdoors” or install where duct can be exposed to direct sunlight. Prolonged exposure may cause degradation of vapor barrier.

Note: Do not install where duct can be exposed to UV radiation from bio-treatment lamps within the HVAC system. Exposure may cause degradation of the inner core.

Note: Do not exceed published pressure or temperature limits.

Note: Do not use duct to hang or support any diffuser, register, or other equipment during installation.

Note: Do not use screws or barbed fitting to make connections on ducts with plain ends.

Note: Duct should be supported at 5' maximum intervals unless resting on ceiling joists or truss supports. 1/2" sag per foot of support spacing is permissible. Vertically installed duct shall be stabilized by support straps at a maximum of 6' on center.

Note: Do not use on oval collars for medium or high pressure.

Warning: Insulated flexible duct contains fiber glass wool which has been classified as a possible cancer hazard by inhalation. Fiber glass wool may cause temporary irritation to skin, eyes, and respiratory tract.

Note: Use a properly fitted NIOSH or MSHA approved dust/mist respirator.

Note: Avoid breathing fiber glass duct.

Note: Avoid contact with skin and eyes.

Note: Wear long-sleeved, loose fitting clothing, gloves and eye protection.

Note: Wash with soap and warm water after handling.

Note: Wash work clothes separately and rinse washer thoroughly.

Note: All tapes, mastics, and non-metallic fasteners used for field installation of flexible ducts shall be listed and labeled to Standard UL-181-B - Closure Systems for use with Flexible Air Ducts and Air Connectors. Non-metallic fasteners are limited to 6" w.g. maximum positive pressure.

Note: It is recommended a minimum 8' of insulated flexible ducting be used between any expansion vent and fan for low noise level.

Note: A multipurpose tool is recommended for duct installation.

Note: Follow all applicable codes and standards.

Installation

1. After desired length is determined, cut completely around the through duct with multipurpose tool. Fold back outer cover and insulation. Apply mastic over fitting and / or inside the inner liner (see figure 2 and 3 on page 16).
2. Slide at least 1" of inner liner over fitting. Seal inner lining to collar. Secure connection with tie placed over the inner lining.
3. Pull outer cover and insulation back over inner lining. Secure connection with tie placed over the outer cover and insulation.

BATHOLOGY

rediscover bathing

www.Bathology.com 847-465-1070

A division of Bathing Brands, Inc.

REV: 03/23

900-0514-0713