

HOW TO USE YOUR

FILTER QUEEN

POW-R CLEAN-UP TEAM®

HMi

HEALTH-NEX INC.

KNOW YOUR NEW

FILTER QUEEN®

POW - R CLEAN - UP TEAM®

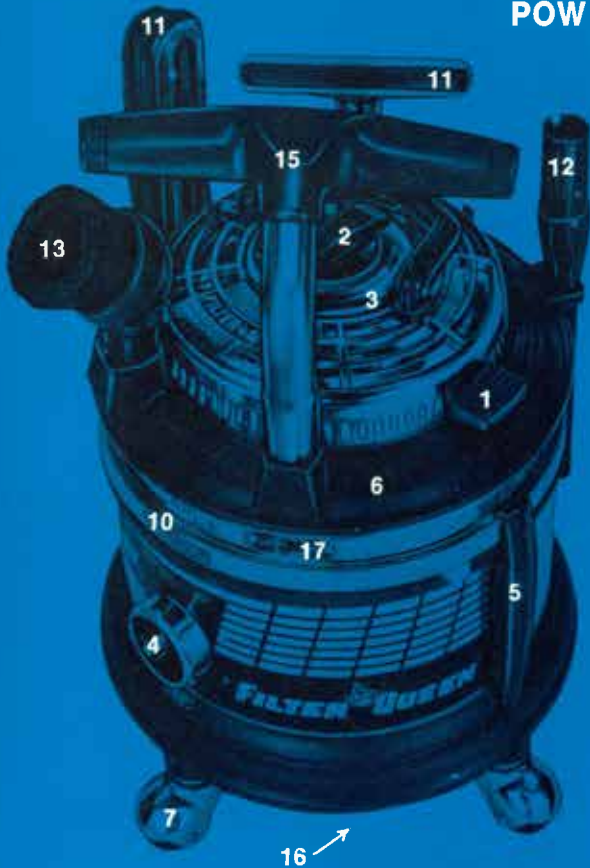

WARNING:
ELECTRIC SHOCK
COULD OCCUR
IF USED OUTDOORS
OR ON WET
SURFACES.
FOR HOUSEHOLD
USE ONLY.

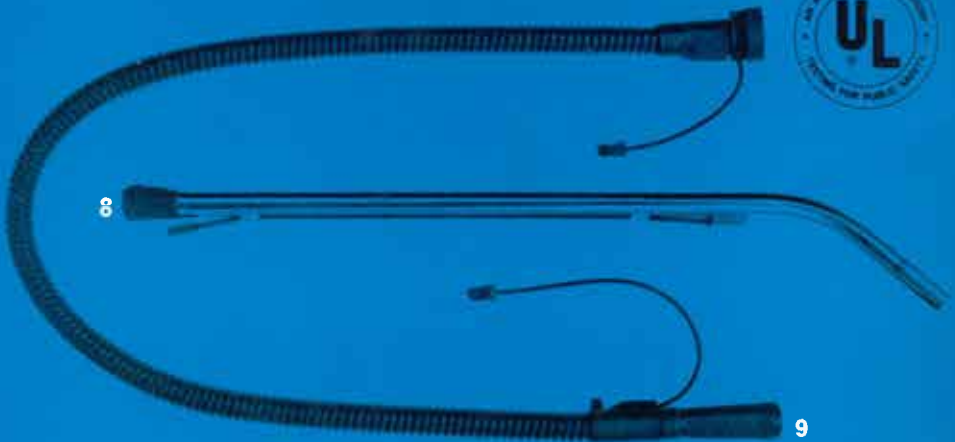

*Available only on certain Filter Queen Models

- 1 STARTER SWITCH**
Press down to start or stop FILTER QUEEN.
- 2 TOP EXHAUST CAP**
Opens with a slight twist to the left to convert your FILTER QUEEN into an efficient blower.
- 3 AIR-SCENTING CHAMBER**
Under Exhaust Cap. Place Oil of Pine or Oil of Eucalyptus.
- 4 SUCTION INLET**
Designed to impart "Cyclonic Action" to incoming air and dust.
- 5 PRESSURE TYPE SIDE CLAMP**
Opens with a flick of your finger. Keeps Power Unit locked in place.
- 6 ATTACHMENT CROWN**
High-impact styrene. Holds five most essential cleaning attachments within easy fingertip reach.
- 7 CASTER SET**
Rubber ball casters roll smoothly on rugs or hard surfaces.
- 8 CHROME-PLATED METAL WAND**
Air-tight, lock-tight single-piece construction.
- 9 HOSE ASSEMBLY**
Vinyl-covered, current-carrying wire reinforced Hose. Listed by Underwriters Laboratories Inc.
- 10 P-R-N FEMALE OUTLET**
Receptacle for plugging in Electric Hose.
- 11 SIX-INCH NOZZLE AND BRUSH**
Removes imbedded dust and dirt from overstuffed furniture, mattresses, drapes, curtains, light drapes, auto upholstery, walls and wood panelling.
- 12 CREVICE TOOL**
For reaching hard - to - get - at places.
- 13 ROUND BRUSH**
For all dusting operations; eliminates the dust cloth.
- 14 POW-R-NOZZLE WITH EDGE CLEANER**
For cleaning rugs and carpets. Motor-driven revolving brush. Soft vinyl bumper on three sides protects furniture from accidental bumps, nicks and scratches.
- 15 TEN-INCH BRUSH**
For cleaning hard-surface floors.
- 16 *AUTOMATIC POWER CORD HOUSING**
For quick convenient cord storage; cord pulls out to desired length . . . a touch of the toe retracts cord automatically.
- 17 *HI-LO POWER SWITCH**
Adjusts suction power to let you easily clean the daintiest curtains without fear of snagging LO . . . yet permits use of full power for regular "deep down" cleaning HI.

CAUTION: DO NOT LEAVE FILTER QUEEN UNATTENDED WHILE MOTOR IS RUNNING. If you are interrupted while cleaning with the Filter Queen Pow-R-Nozzle, (e.g. phone calls, unexpected visitors, etc.), be sure to first turn off power by pressing Starter Switch on the Filter Queen. This also automatically turns off the Pow-R-Nozzle. Failure to do so may result in overheating of motors and subsequent damage to the Filter Queen System and/or floor coverings.

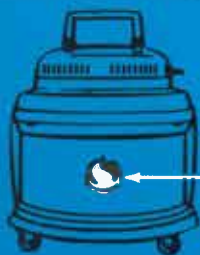

use this
SUCTION INLET
for Vacuuming
and Dust Removal



use this
BLOWER OUTLET
for Air-scenting and
Air-circulation

HOW TO ATTACH THE FILTER QUEEN POW-R-NOZZLE TO YOUR FILTER QUEEN

ATTACH end of Wand with rubber sleeve to round swivel neck of Nozzle BY PUSHING Wand OVER NECK until LOCKING PIN SNAPS into retaining slot. Thumb release button on rubber sleeve should be in line with metal locking pin on swivel neck. The Wand swivels slightly more than 90°, allowing it to lie flat on floor for cleaning under low furniture. JOIN male plug end of cord extending from Nozzle with lower end of Wand cord by firmly pushing together as shown in Fig. 4.

1

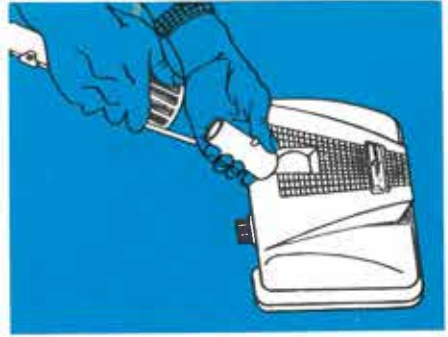

ATTACH Electric Hose to other end of Wand until locking pin SNAPS into retaining slot. PLUG short length of cord extending from Hose end into male connector attached to upper end of Wand. NOTICE: THIS CONTAINS ELECTRIC WIRES.

2

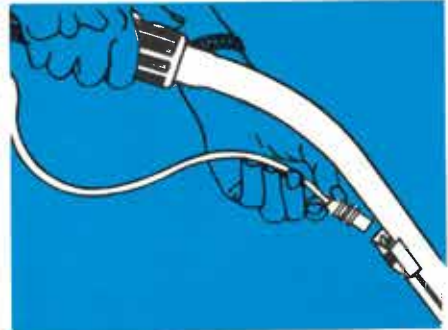

ATTACH other end of Hose to Filter Queen Power Unit by lining up white arrow over top pin of Suction Inlet. Lock with slight turn to right. PLUG CORD with round male pins into P-R-N Female Outlet on dome. Operation of Pow-R-Nozzle is controlled by PRESSING Starter Switch on the Filter Queen Power Unit. Nozzle motor will run only when the Filter Queen is "ON," and will stop when the Filter Queen is "OFF."

3

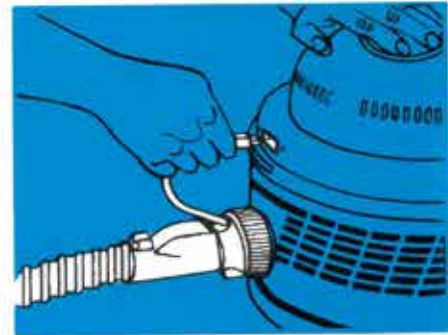

Height of Nozzle from rug surface is controlled by rollers protruding through bottom coverplate of Nozzle. Height of rollers is adjusted by knob in back of Nozzle. For SHORT NAP RUGS, such as "indoor-outdoor," pointer on knob should be SET AT "LO." With HIGHER NAPPED RUGS and carpeting ADVANCE pointer clockwise to proper Nozzle height. For extremely HIGH PILE SHAGS a Shag Rug Rake is available as optional equipment; see back cover.

4

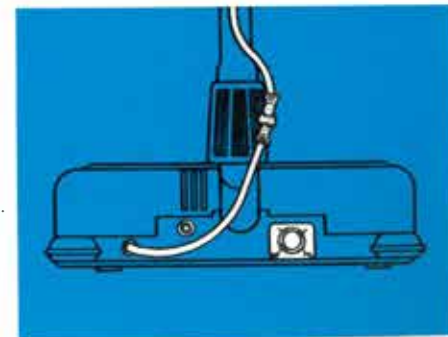

HOW TO ASSEMBLE YOUR FILTER QUEEN FOR CLEANING WITH OTHER ATTACHMENTS

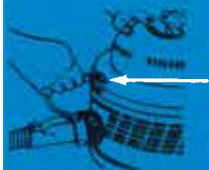

- 1 Leave Electric Hose attached to Power Unit, as described on page 4. Detach Pow-R-Nozzle from end of Wand; ALSO UNPLUG CORD AT HOSE END FROM P-R-N FEMALE OUTLET ON POWER UNIT DOME.

You may use the Round Brush, Crevice Tool or the Six-Inch Nozzle and Brush from end of the Wand; or from the end of Electric Hose.



- 2 When using end of Electric Hose, first disconnect plug from top of Wand (just below curved section) and insert into Retainer Clip at end of Hose so it is out of the way. Then disconnect Wand from Hose by pressing down on rubber button and pulling apart. Your Electric Hose is now ready to use with any of the above-described attachments.



- 3 To attach cleaning tool to Hose, line up metal button on tool with rubber button on Hose and press together till they click in place.



- 4 Press STARTER SWITCH.

HOW TO USE THE AIR-SCENTING CHAMBER

NOTE: Disconnect Electric Hose from Power Unit before using Air-Scenting Chamber.



- 1 Remove EXHAUST CAP on top of FILTER QUEEN with slight turn to the left and lift off.



- 2 Place a few drops of Filter Queen Oil of Pine or Oil of Eucalyptus on grey felt Air-Scent pad. CAUTION: Do not saturate or use perfume or other liquid not sold by Health-Mor Inc.! Use of other liquids could cause damage to your motor. (To replace felt Air Scent Pad, twist clamp to the left and lift off; insert new Pad. Replace clamp, lock in position.)



- 3 Close AIR-SCENTING CHAMBER by replacing CAP and locking with slight turn to right until it clicks into place.



- 4 Press STARTER SWITCH. Within minutes you will notice the effects of your FILTER QUEEN AIR-SCENTING CHAMBER THROUGHOUT THE ROOM.

HOW TO CHANGE THE FILTER CONE

About once a month (or when Dirt Container is full) empty your Filter Queen and insert new Filter Cone. To do this:



- 1 *Unplug Pigtail Connecting Cord from socket in Caster Base.
- 2 Release Side Clamps and lift off Filter Queen Power Unit.



- 3 Place 2 or 3 layers of newspaper over top of Dirt Container (see illustration); hold tightly against Container. Turn upside down so dirt and used Filter Cone are deposited on newspapers. Tap bottom of Container to remove all dirt. Slowly remove Container. Carefully wrap newspapers and throw away.



- 4 Open new Filter Queen Filter Cone; Insert point of Cone into Filter Cone Locator at bottom of Dirt Container. Be sure that all edges of Cone are even with rubber collar of Dirt Container.



- 5 Replace Power Unit and lock Side Clamps in place by pressing them against Dirt Container. Be sure all three tabs of Cone show outside of Power Unit (see arrows in illustration).



- 6 *Plug Pigtail Connecting Cord into socket in Caster Base.

HOW TO CHANGE THE SECONDARY FILTER

If your Filter Queen is run without a Filter Cone (or with Cone improperly installed) dust lodges on the Secondary Filter, which must then be replaced to restore full suction efficiency. To do this:

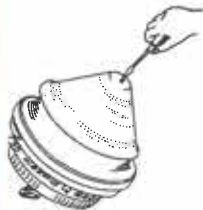

- 1 Unlock Power Unit to expose the metal cone guard. Remove cone guard by taking out retaining screw in the bottom.



- 2 After removing cone guard, the Secondary Filter is fully exposed. Pry up under grommet edge and slip Filter disc out from rubber lip holding it in place.



- 3 Place new Secondary Filter over center rubber grommet; push it underneath lip of grommet.



- 4 With new Filter now under center grommet, tuck outside edges under rubber lip around its entire circumference.



- 5 Replace metal cone guard. Be sure the outer edge of the cone is seated in rubber lip around its circumference as shown.



- 6 Replace retaining screw and your FILTER QUEEN is ready for another long period of top efficiency. Reassemble with new Filter Cone.

HOW TO CLEAN YOUR CARPETING WITH THE POW-R-NOZZLE

Attach Pow-R-Nozzle to Filter Queen as shown on page 4. Adjust height of Nozzle rollers to type of rug or carpeting you are cleaning ("LO" for shortnap; "HI" for shag or sculptured carpeting). After you've used your Pow-R-Nozzle a few times you'll know which adjustment gives the best cleaning results. Vacuum in long, slow strokes. When cleaning your shags, vacuum in a criss-cross pattern to raise the nap and give them a fluffier appearance.

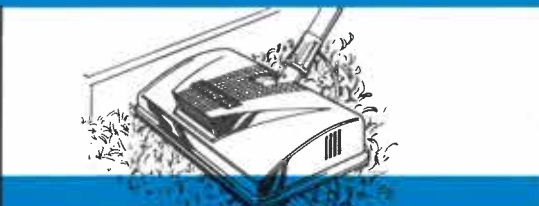
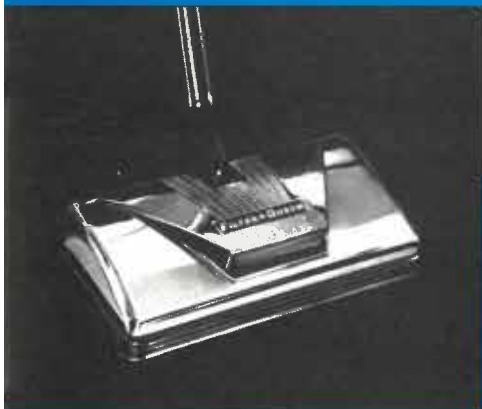

TO EDGE CLEAN: When you come to edge of wall-to-wall carpeting, turn Nozzle at a 90° angle to the wall. This allows powerful air flow from edge of Nozzle to clean right up to baseboard.

HOW TO CLEAN STAIRS WITH YOUR POW-R-NOZZLE:

Disconnect plug from lower end of Wand to Pow-R-Nozzle. Detach Wand from Hose by pressing down on rubber button and pulling apart. Connect Hose to Pow-R-Nozzle; reconnect male plug from end of Hose into female plug at Nozzle. Pow-R-Nozzle may now be used to clean stair carpeting, overstuffed furniture, car interiors, mattresses, etc. On narrow steps and risers, use Six-Inch Nozzle attached directly to Hose instead of Pow-R-Nozzle. (See page 5 on how to attach Six-Inch Nozzle.)

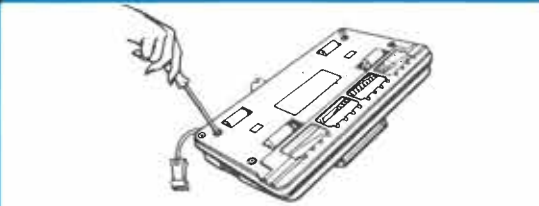

HOW TO CARE FOR YOUR POW-R-NOZZLE:

Periodically remove top cover and check belt for tension and wear. To remove cover, unfasten four screws marked "TO REMOVE TOP." To adjust or replace belt and brush, see instructions on label attached to inside surface of baseplate. To remove baseplate, unfasten two screws marked, "TO REMOVE BOTTOM PLATE" and unhook from lip of Nozzle. Remove any lint, nap or other debris that may have accumulated in motor compartment or behind roller bar by vacuuming with Crevice Tool attached to Hose. Also remove debris buildup on ends of brush. Be sure to re-insert fiber and steel washers. Replace plate by securely hooking under front lip of Nozzle; replace two screws. Replace top cover and four screws.

STORAGE: Avoid sharp bends in Electric Hose by draping over a clothes hanger — or two closet hooks spaced about 12-inches apart.

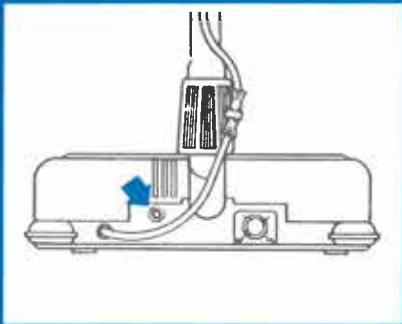

RESETTABLE CIRCUIT BREAKER: Your Pow-R-Nozzle is equipped with a resettable circuit breaker. The circuit breaker will protect your motor from damage if the Pow-R-Nozzle should become clogged or the revolving brush stalls. (This could be caused by picking up a long strand of rope or a large object, such as a sock.) If for any reason the circuit breaker stops the Pow-R-Nozzle, unplug the cord and correct the problem by removing foreign object from brush. Then press red Reset Button located on back of Pow-R-Nozzle (see arrow on illustration) and start unit in usual manner.

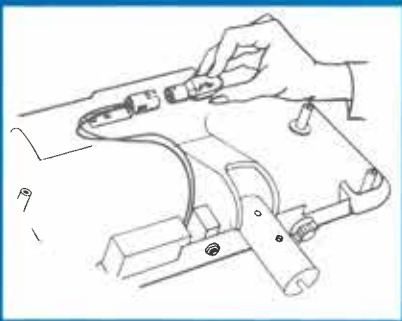

HOW TO REPLACE HEADLIGHT: Disconnect Filter Queen power cord from electrical outlet and disconnect plug from lower end of Wand to Pow-R-Nozzle. Detach Wand from Pow-R-Nozzle by pressing down on rubber button and pulling apart. Remove top cover by unfastening the four screws which are marked, "TO REMOVE TOP." To remove bulb, press inward and twist to the left. Replace with 15 watt bulb (Sylvania 15 T7 DC or equivalent). Push new bulb into socket and lock into position by twisting to the right. Replace top cover and four screws.

USE THE TEN-INCH BRUSH TO CLEAN ALL YOUR HARD FLOORS AND WALLS, TOO

Cleans an entire 10-inch wide area in one stroke. Ideal for hard-surfaced floors such as tile, linoleum, wood and even concrete. Also cleans walls, screens, ceilings, shades, any flat surface. To attach Brush: First, unplug Pow-R-Nozzle cord from Wand. Remove Pow-R-Nozzle from Wand by depressing coupling button and pulling apart. Next, insert metal end of Brush into rubber end of Wand and use in same manner as Pow-R-Nozzle. (NOTE: When cleaning wall surfaces, work in a straight line from the bottom up; overlap each succeeding Brush stroke.) After each use, remove lint, threads, etc., by rubbing Brush with open end of Hose (see illustration). If Brush is soiled, rinse in mild soap solution and let dry before using on light-colored walls or ceilings.





USE THE ROUND BRUSH FOR EASY "DUST-FREE" DUSTING

Do all your general dusting with the Round Brush. Use on highly polished furniture, the most delicate cloth lampshades — or any surface where dust accumulates.

TO USE BRUSH: Assemble Filter Queen for "Cleaning with other Attachments," as shown on page 5.

FOR GENERAL ROOM DUSTING: Attach Brush directly to Hose. Clean with gentle short strokes; do not press down hard as this will seal the opening and cut off your cleaning power. Use on tables, window sills, ledges, lampshades, statuary, woodwork, books, bookshelves, ashtrays, drawers, radio and TV grills, etc.

TO DUST HIGH MOULDINGS, DOOR JAMBS, ETC.: Use Wand and the Round Brush. To clean top of mouldings have Brush turned down. For underside of mouldings, Brush should point up.

TO CLEAN BRUSH: Run open end of Hose over bristles of Brush. (You will find this method convenient for keeping all kinds of brushes clean. If you have been dusting grimy or very sooty surfaces, remove bristle assembly from rubber socket, wash in warm soapy water; let dry before replacing.)

Book Shelves and Books

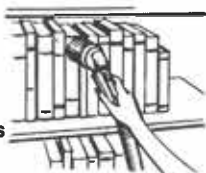

High Mouldings and Door Jambs



Venetian Blinds

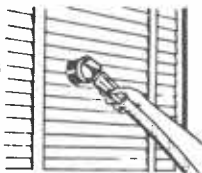

Furniture Dusting

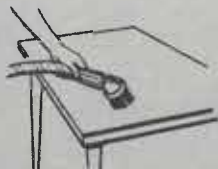

Lamps and Lamp Shades



**FOR THOSE
HARD-TO-GET-AT
PLACES USE THE
CREVICE TOOL**



Assemble Filter Queen for "Cleaning with other Attachments," as shown on page 5.

Use Crevice Tool for removing dust and dirt behind cushions in upholstered furniture; mattress tufts and bindings; bed springs; corners of bureau drawers; radiators; any place where other attachments cannot reach.



Corners and Quarter Rounds

Between Cushions



**USE THE SIX-INCH
NOZZLE AND BRUSH
ON UPHOLSTERED
FURNITURE, DRAPERIES
AND CURTAINS**



How to Attach Brush to Nozzle



Assemble Filter Queen for "Cleaning with other Attachments," as shown on page 5. **CLEANING OVERSTUFFED FURNITURE, MATTRESSES, FABRICS:** To remove deeply imbedded dirt in heavy fabrics, use the Six-Inch Nozzle without Brush. Use the Brush when fabric is covered with threads, lint, etc. When cleaning mattresses, upholstered furniture, clothing and other off-the-floor objects, attach Nozzle directly to the Hose.

GOING OVER CURTAINS, DRAPES: Attach Wands to Hose. For heavy drapes, attach Six-Inch Nozzle only direct to Wand. Delicate curtain material should be cleaned with the Six-Inch Nozzle and Brush. The Brush prevents the material from being drawn into the Nozzle. Slide Brush on the Nozzle.

HEALTH-MOR INC. LIMITED WARRANTY

Health-Mor warrants the Filter Queen Home Sanitation System and its accessories, except the hose, to be free of defects in material and workmanship for two years from the date of purchase. The warranty on the hose is limited to one year from the date of purchase. This warranty does not cover: (1) use of the Filter Queen for commercial, institutional, professional, rental or other non-household purposes; (2) ordinary wear to the hose, brushes, belts, bearings, seals or floor polishing felt pad; (3) damage occurring through misuse or negligence; (4) damage caused by use on a current or voltage other than that stamped on the nameplate; (5) damage resulting from service work performed by other than Health-Mor Inc. or its authorized Distributors; and (6) cost of transportation, pick-up, delivery, house or service calls.

Health-Mor Inc. will repair or replace any defect or defective part under this warranty provided the Filter Queen or the defective part is returned, transportation prepaid, with proof purchase date, to the authorized Distributor from whom it was purchased or to Quality Assurance Department, Health-Mor Inc., 3500 Payne Avenue, Cleveland, Ohio 44114, or, with written authorization from Health-Mor Inc., to any other person authorized to perform warranty service. Information regarding other persons authorized to perform warranty service can be obtained by writing to the Customer Relations Department, Health-Mor Inc., 151 East Twenty-Second Street, Lombard, Illinois 60148. If the Filter Queen or part is found on inspection to be defective in material or workmanship it will be repaired or replaced at the option of Health-Mor Inc. and returned to the sender, freight or postage collect. No reimbursement will be made for replacement of defective parts or service performed during the warranty period if done by anyone other than the authorized Distributor from whom the Filter Queen was purchased or by Health-Mor Inc., without first having obtained written authorization from Health-Mor Inc.

In order to make this warranty effective, the Registration Card attached to the instruction manual must be filled out, signed by the authorized Distributor from whom the Filter Queen was purchased and returned to Health-Mor Inc. indicating the name and address of the purchaser, the date of purchase and the serial number of the Filter Queen.

This warranty is null and void and of no effect unless all of the following conditions are met: (1) the Filter Queen was purchased from an authorized Distributor; (2) the serial number of the Filter Queen and the date of sale are filled in on the Filter Queen Registration Card; (3) the authorized Distributor has signed the Registration Card; (4) the card is returned to Health-Mor Inc.; and (5) the manufacturer's serial number for the Filter Queen has not been changed, defaced or removed.

Any repair or replacement of a defect or defective part under this warranty will be warranted for one year or until the end of the original warranty period, whichever is longer.

There is no other express warranty applicable to your Filter Queen. Implied warranties, including warranties of merchantability and fitness for a particular purpose, are limited in duration to the period of time during which the express warranty given herein is in effect. All consequential or other damages resulting from a breach of this warranty are excluded from coverage under this warranty.

Some states do not allow limitations on how long an implied warranty lasts, or do not allow the exclusion or limitation of incidental or consequential damages, so the above limitations or exclusions may not apply to you.

Neither Health-Mor Inc., nor its authorized Distributors, assumes or authorizes anyone to assume for any of them any additional liability.

This warranty gives you specific legal rights, and you may have other rights which vary from state to state.

HEALTH-MOR INC.

SERVICE AND LOSS BY FIRE POLICY

Health-Mor Inc. agrees to rebuild the electrical system of the Filter Queen cannister at any time after expiration of the original warranty period, subject to the terms and conditions set forth below:

1. The Filter Queen must be in the possession of the original owner and must have been used only for household purposes. This service policy does not apply to any Filter Queen used for commercial, institutional, professional, rental or other non-household uses.
2. The Filter Queen must be returned, transportation prepaid, to the authorized Filter Queen Distributor from whom it was purchased or to the Quality Assurance Department, Health-Mor Inc., 3500 Payne Avenue, Cleveland, Ohio 44114. The owner must pay return transportation charges.
3. The maximum charge for rebuilding the electrical system of the Filter Queen cannister will be \$49.50, which will include the cost of all parts and labor necessary to restore the Filter Queen electrical system to correct operating condition. A charge will be made at then-current prices for any parts missing from the Filter Queen at the time it is delivered for rebuilding if such parts are necessary to restore the Filter Queen to correct operating condition and for any parts needed or requested other than the electrical system of the cannister.
4. If there is a defect in material or workmanship in the rebuilding, the Filter Queen will be rebuilt again at no charge, provided the Filter Queen is returned within one year of the prior rebuilding to Health-Mor Inc. or the authorized Distributor who performed the rebuilding, transportation prepaid. Proof of the prior rebuilding must accompany the Filter Queen.
5. If the Filter Queen Unit and/or attachments are destroyed or damaged by fire while in the home of the original owner within three years from the date of original purchase, Health-Mor Inc. will repair and rebuild the Filter Queen for the original owner so as to place the machine in correct operating condition. To take advantage of this fire rebuilding policy, the fire-damaged remains of the Filter Queen must be sent within 90 days of the fire, transportation prepaid, to Health-Mor Inc., 3500 Payne Avenue, Cleveland, Ohio 44114 along with a check in the amount of \$100.00 and an affidavit that the Filter Queen was damaged or destroyed by fire while in the home of the original owner.
6. This service agreement is void and inapplicable unless all of the following conditions are met:
 - a) The Filter Queen was purchased from an authorized Distributor;
 - b) The serial number of the Filter Queen and the date of sale are filled in on the Filter Queen registration card;
 - c) The authorized Distributor has signed the registration card;
 - d) The card is returned to Health-Mor Inc.;
 - e) The manufacturer's serial number for the Filter Queen has not been changed, defaced or removed;
 - f) Damage to the power plant did not occur by reason of misuse, negligence, use on a current or voltage other than that stamped on the nameplate or by use of other than genuine Filter Queen liter cones.

DO-IT-YOURSELF SERVICE CHART

CORRECTION

PROBLEM

LOSS OF SUCTION — OR OVERHEATING OF MOTOR (UNIT)

1. Clogged Secondary Filter
2. Obstructed Hose
3. Obstructed Wand
4. Dirt Container full
5. Obstruction at neck of Pow-R-Nozzle swivel
6. Filter Cone coated with extremely-fine dust

1. Replace Secondary Filter. (See instructions on page 6.)
2. See instruction (5) below under "POW-R-NOZZLE DOES NOT OPERATE . . ."
3. Run long wire or a straightened-out coat hanger through Wand.
4. Empty and clean Dirt Container. Replace Filter Cone with new one.
5. See instruction (3) below under "POW-R-NOZZLE DOES NOT OPERATE . . ."
6. Replace Filter Cone. Also replace Secondary Filter (see instructions on page 6).

MACHINE WILL NOT OPERATE

1. Plug not connected to wall outlet, or to faulty wall outlet
2. * Pigtail Connecting Cord not plugged in
3. Damaged switch
4. Damaged motor
5. Damaged Power Cord Plug

1. Insert plug firmly in wall outlet, or try another wall outlet.

2. * Insert Pigtail Connecting Cord firmly into socket located in caster base.
3. Call factory authorized Filter Queen Service Center.
4. Call factory authorized Filter Queen Service Center.
5. **AUTOMATIC CORD REWIND:** After checking Pigtail Cord* connection — see (2) above — and machine still doesn't operate, plug Pigtail Cord directly into wall outlet. If machine now operates, this may indicate damaged Power Cord Plug.

* Automatic Cord Rewind Model only.

POW-R-NOZZLE DOES NOT OPERATE OR PICK UP

1. Hose Plugs not connected
2. Brush not turning
3. Obstruction at neck of swivel (see Fig. 1, page 4)
4. Obstructed Wand
5. Obstructed Hose
6. Worn Brush
7. Circuit Breaker Tripped

1. Review instructions, page 4, on "HOW TO ATTACH THE POW-R-NOZZLE . . .", making sure all plugs are firmly connected.
2. Remove baseplate and check belt. Be sure belt is attached to motor shaft. If belt is broken, replace. See instructions on inside of baseplate.
3. Remove baseplate and clean dirt and debris from swivel neck by running wire through opening. At the same time remove any lint, nap or other debris from behind Roller Bar.
4. Run long wire or a straightened-out coat hanger through Wand.
5. Remove Hose from Filter Queen Power Unit; then push broom handle gently down Hose (from end that was connected to Power Unit) forcing obstruction out other end.
6. See instructions 2 & 3 on bottom of baseplate.
7. Unplug cord and check for obstruction at brush (see page 8). After problem is corrected, push red Reset Button on back of Nozzle and start Filter Queen in usual manner.

If after checking all the above, and your POW-R-NOZZLE still doesn't operate, then probably (a) The POW-R-NOZZLE motor is damaged or (b) There may be a damaged cord on your Electric Hose. In which case, contact your factory-authorized Filter Queen Service Center, or Health-Mor Inc.

SQUEAKY ROLLERS ON POW-R-NOZZLE

Remove baseplate and apply liquid wax to axles of Rollers.

OPTIONAL ACCESSORIES THAT HELP YOU GET MORE SERVICE FROM YOUR FILTER QUEEN!



POW-R-NOZZLE HIGH PILE SHAG RUG RAKE

For those very-hard-to-clean, long-yarn "shaggy" shag carpets, here's another Filter Queen exclusive — the POW-R-NOZZLE SHAG RUG RAKE. Easily attaches to the POW-R-NOZZLE . . . rakes, combs, and elevates Nozzle necessary distance to separate the yarns so Filter Queen's powerful suction action gets down to the base of the carpet to remove smallest bits of litter. (Order Model 84 SHAG RUG RAKE.)

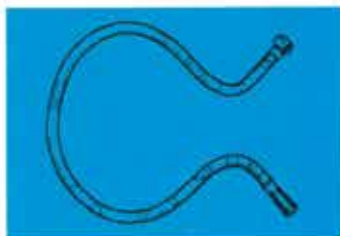

STANDARD HOSE

Non-electric Filter Queen Hose. Sturdy vinyl dirt-resistant covering; wire reinforced. 360° swivel prevents kinking or knotting. Available in 6½, 10 or 15 foot lengths. Choice of tan or dark brown.



FOURTEEN-INCH BARE FLOOR BRUSH

A long-bristled brush ideally suited for all hard surface flooring — even concrete! Fourteen-inch width. (Requires adaptor tube. When ordering Brush, also order "Adaptor for Pow-R-Nozzle.")