

WAIWELA

Mini Tank

Electric Mini Tank – Water Heaters

WM-1.0

WM-2.5

WM-4.0

WM-6.0



Installation and Operating Instruction Manual

Sold by www.GadgetsGo.com Authorized Dealer

Table of Contents

Important Safety Instructions	3
General Information	3/6
Technical Data	4 - 5
Technical Description	6
Installation Instructions	7
Plumbing Connections	7
Temperature & Pressure Relief Valve	8
Filling The Water Heater	9
Electrical Connections	10
Instructions For Use	10 - 11
Maintenance Instructions	11 - 14
Troubleshooting	15
Warranty	15 - 16/19
Schematic Disassembly & Parts List	18

Important safety instructions

Warning : When using electrical appliances, safety precautions to reduce the risk of fire, electric shock or injury to persons should be followed, including:

1. Read all these instructions before using this water heater.
2. This water heater must be grounded. Connect only to properly grounded outlet. See “Grounding instructions” found on page 10.
3. Install or locate this water heater only in accordance with the provided installation instructions.
4. Use this water heater only for its intended use as described in this manual.
5. Do not use an extension cord set with this water heater. If no receptacle is available adjacent to the water heater, contact a qualified electrician to have one properly installed.
6. As with any appliance, close supervision is necessary when used by children.
7. Do not operate this water heater if it has a damaged cord or plug, if it is not working properly, or if it has been damaged or dropped.
8. This water heater should be serviced only by qualified service personnel. Contact nearest authorized service facility for examination, repair, or adjustment.

Save these instructions

The manufacturer and/or distributor is not responsible for damages caused by improper installation, or by non observance of the instructions in this manual.

A qualified, licensed technician must always install the water heater and conduct all subsequent service work and or maintenance.

Important: Never turn the water heater power on until the tank is completely full and water is flowing out of the hot water faucet.

General Information

The WaiWela Mini Tank water heaters can be used in most under the counter, point of use applications. Models WM-1.0, WM-2.5, WM-4.0 and WM-6.0 are designed to supply hot water for hand washing in a residential, commercial or industrial environment. The WaiWela mini tank water heaters are slow recovery, small reservoir, not intended for showers or filling tubs. The WaiWela Mini tank water heaters are lightweight and compact and manufactured for easy installation. The WM-1.0, WM-2.5, WM-4.0 and WM-6.0 are designed to be mounted on the wall. Not sure call us at 800.605.6542.

Technical Data

Model		WM-1.0	WM-2.5	WM-4.0	WM-6.0
Capacity	Gallons	1.3	2.5	4.0	6.0
Voltage	Vac	110-120	110-120	110-120	110-120
Power at 120 Vac	Watts	1440	1440	1440	1440
Max. Water Pressure	psi	150	150	150	150
Weight (empty)	lbs.	12 1/2	20	24	26
Amperage	Amps	12	12	12	12
Phases		1	1	1	1

Assembly Figure

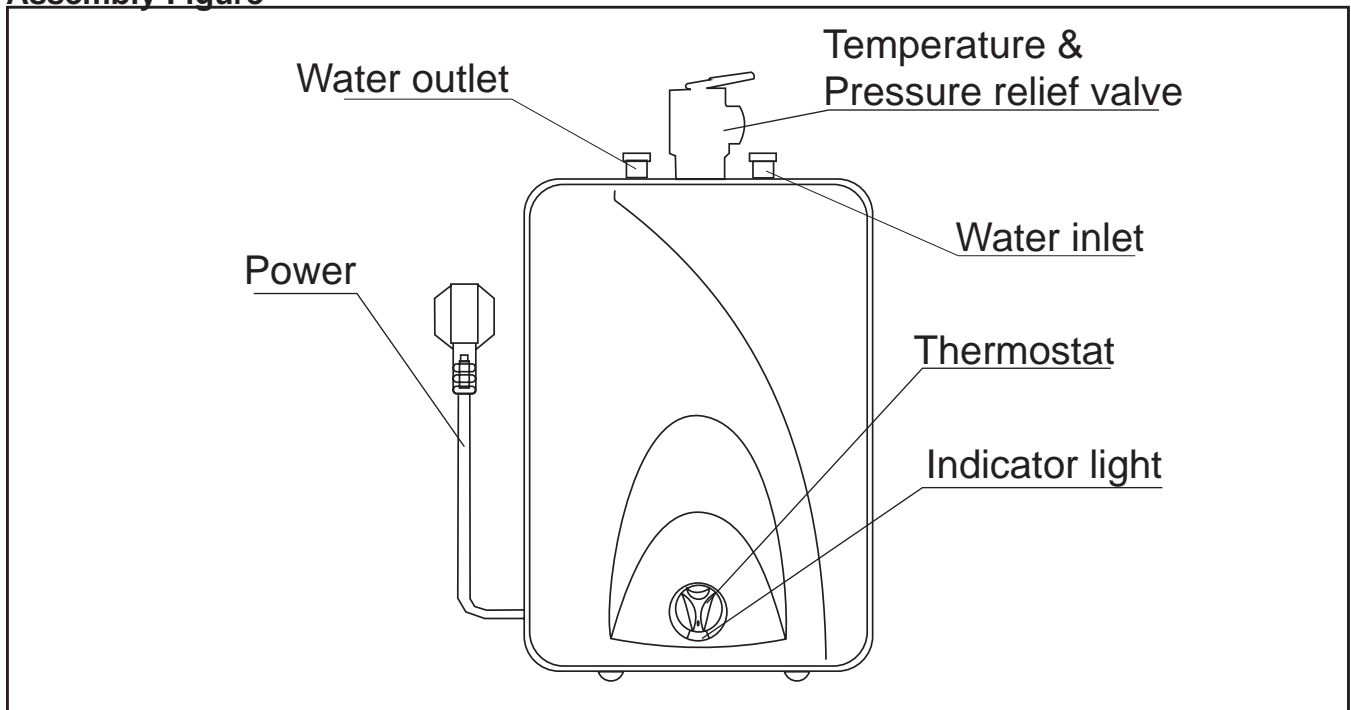

Water Flow Figure

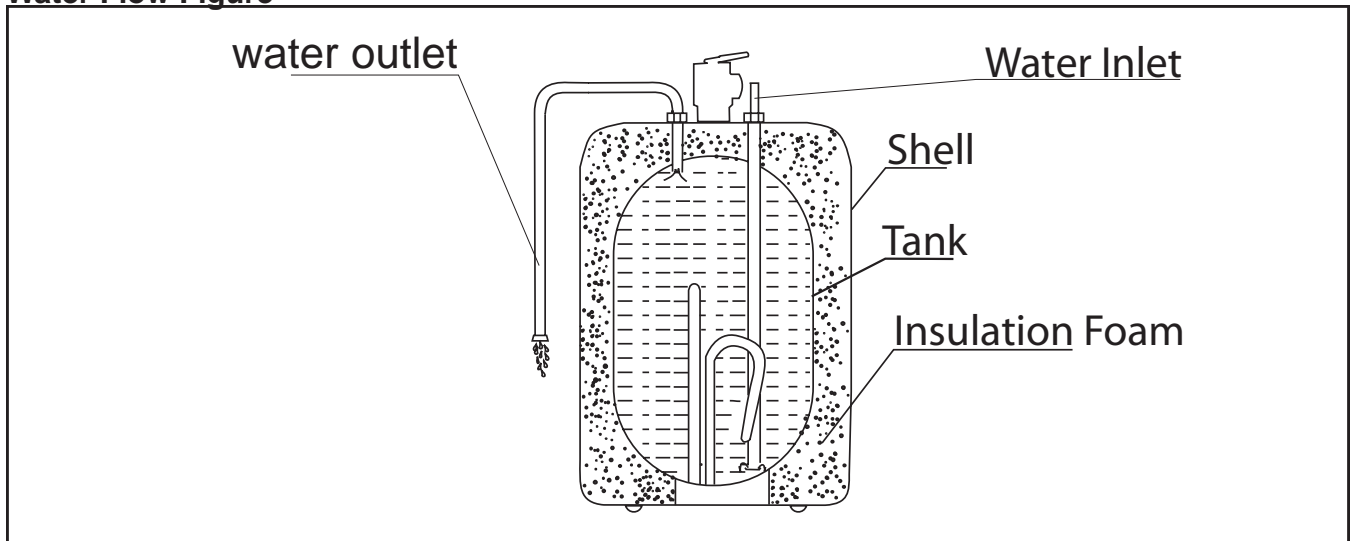

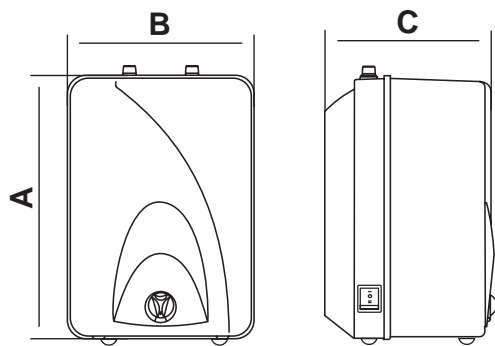

Dimensions

Model	WM-1.0	WM-2.5	WM-4.0	WM-6.0
A (inch)	12 1/2"	14 1/2"	19 1/4"	18"
B (inch)	11"	11 3/4"	11 3/4"	15 3/4"
C (inch)	10"	10 3/8"	10 3/8"	15 1/2"

Schematic Construction

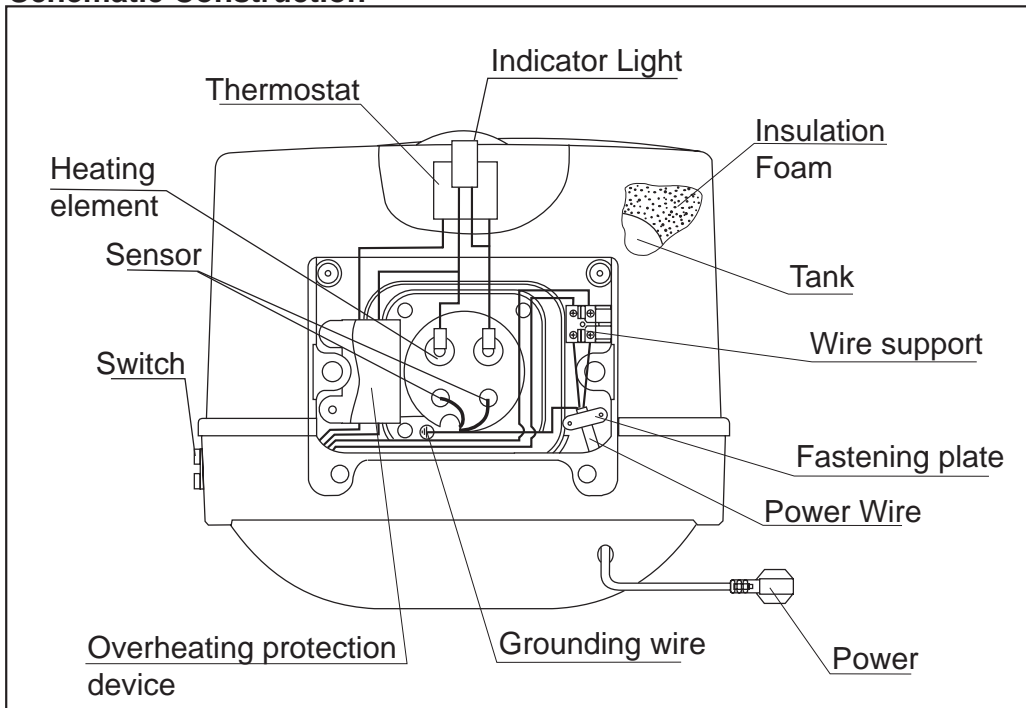

Thermostat

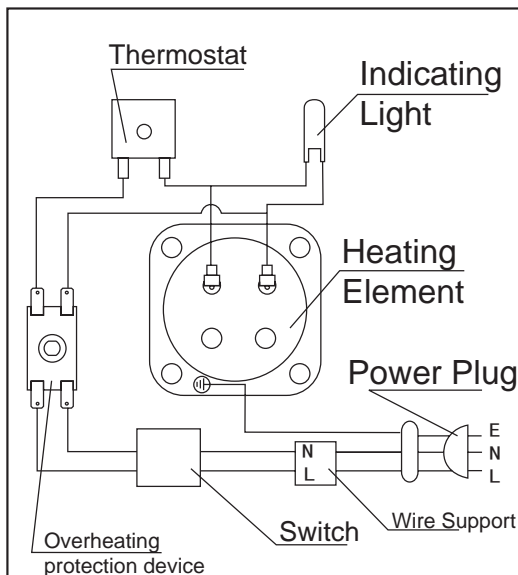

Wiring Diagram

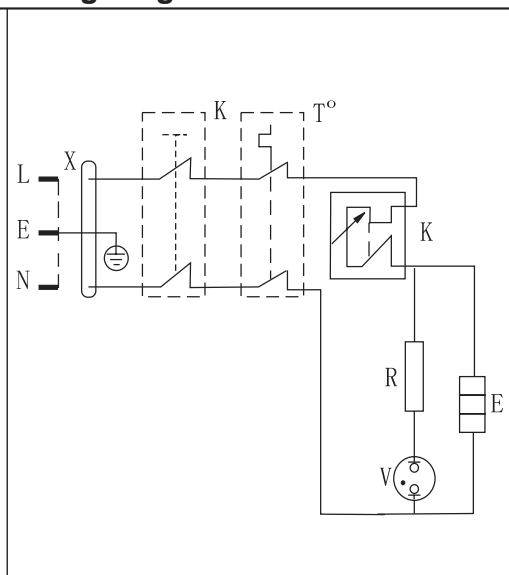

General Information Cont.

The WM-1.0, WM-2.5, WM-4.0 and WM-6.0 are designed to operate at 150 psi maximum water pressure. Install a pressure reducing valve if your water pressure is greater than 80 psi.

Caution: The manufacturer cannot be responsible for the damage caused by improper installation or by failure to follow instructions in this manual. Comply with the Installation Instructions before connecting to electrical outlet.

Caution: The thermostat has been pre-set at the factory between 41°C (105°F) and 45°C (113°F).

Caution: Hydrogen gas can be produced in a hot water system served by this heater that has not been used for a long period of time (generally 2 weeks or more). Hydrogen gas is extremely flammable. To reduce the risk of injury under these conditions, it is recommended that the hot water faucet be opened for several minutes at the nearest and most distant sink being served by this water heater before using any electrical appliance connected to the hot water system i.e. Dishwasher. If hydrogen gas is present, there will probably be an unusual sound such as air escaping through the faucet as the water begins to flow. There should be no smoking or open flame near the faucet at this time.

Warning: Installer should review the contents of this manual with the owner upon completion of the installation, and the manual should remain with the owner and placed in a location close to the water heater.

Technical description

There are four WaiWela Mini tank models, a 1.0, 2.5, a 4.0 and a 6.0 gallon model. The pressure vessel (water tank) is welded, glass lined steel and is equipped with an anode rod. The water heater is equipped with a thermostat and a high limit temperature switch. A temperature pressure relief valve is supplied with the unit.

Installation instructions

WM-1.0/WM-2.5/WM-4.0/WM-6.0

The installation must be completed by a licensed professional. All state and local codes must be adhered to. The manufacturer will not be liable for any damages because of failure to comply with these installation instructions or because of improper installation performed by an unqualified installer. Choose a location that allows ease of access for maintenance or servicing, ideally installed at least 8" to 9" from the ceiling (inside top of cabinet) or any adjacent walls.

Wall mounting

Fasten the supplied mounting bracket to the wall. Use screws that are suitable for the wall material and the weight of the water heater filled to capacity (WM-1.0 = 24 lbs WM-2.5 = 41 lbs, WM-4.0 = 57 lbs, WM-6.0 = 76 lbs). Hang the water heater on the bracket and pull downwards on the water heater to insure that both "fingers" of the bracket are seated in the mounting slots. Confirm your water piping orientation (hot and cold) before wall mounting. **Only install in vertical position.** The heater can sit on the floor in a tray with a drain. Confirm water piping orientation before finalizing on floor. **Again, only install in vertical position!** Models WM-1.0, WM-2.5, WM-4.0 and WM-6.0 can be installed under the sink.

Plumbing connections

Connect the cold water inlet pipe to the inlet nipple (marked with a blue ring) and the hot water outlet pipe to the outlet nipple (marked with a red ring).

Important: If Water pipes are copper or bronze, use dielectric connections to prevent corrosion. Failure to provide dielectric insulation may result in premature tank or nipple failure and may void your warranty. Insure that the water heater is installed in a level position. Install a shut off valve on the cold water side of the water heater. The valve is for servicing and the valve should be in the open position when the water heater is in operation. In order to protect the water heater from heat damage due to soldering, solder a piece of tubing to a threaded union fitting before screwing the union to the tank. **Do not apply heat directly to inlet or outlet connections.**

Temperatures and pressure relief valve:

Caution : Install the Temperature/Pressure Relief Valve supplied with the water heater!

Install a discharge pipe from the temperature/pressure relief valve terminating at a sink or drain. Do not cap or plug the end of the discharge pipe. The discharge pipe must be unobstructed and full sized.

The T/P valve is certified by a nationally recognized test lab that maintains periodic inspections of the listed equipment and meets the requirements for relief valves and automatic shut off devices for hot water supply systems ANSI 121.22-1979.

The T/P valve is marked with a maximum pressure, which does not exceed the maximum working pressure of the water heater (150 PSI).

Install the T/P valve into the threaded opening at the top of the water heater using heavy duty Teflon tape.

Do not over tighten! Orient the discharge tubing so that any discharge from the valve will exit within 6 inches above, or at any distance below the structural floor, and cannot contact any live electrical part.

T/P Valve Discharge pipe:

1. Must be smaller in diameter than the outlet diameter of the valve, or have any reducing couplings.
2. Must not be plugged or blocked.
3. Must be made of suitable material for hot water.
4. Must not be over 15' in length.
5. Must not have more than two elbows.
6. Must terminate at an adequate drain.
7. Must not have a shut off valve between relief valve and tank or relief valve and termination of discharge.

Closed system thermal expansion:

Periodic discharge of the T/P relief valve or failure of the element gasket may be due to thermal expansion in a closed water supply system. The water utility supply meter may contain a check valve, back flow preventer or water pressure reducing valve which will create a closed water system. During the heating cycle of the water heater, the heated water expands causing pressure inside the water heater to increase. The T/P relief valve may discharge hot water under these conditions which results in a loss of energy and a build up of lime on the relief valve seat.

To prevent this from happening, there are two recommendations:

1. Install a diaphragm-type domestic hot water expansion tank (suitable for potable water) on the cold water supply line. The expansion tank must have a minimum capacity of 1.5 U.S. gallons for every 50 gallons of stored water.
2. Install a 125 PSI pressure relief valve in the cold water supply line. Make sure the discharge of this valve is directed to an open drain and protected from freezing. Contact your local water utility or plumbing inspector for information on how to control this situation. Never plug the outlet of the relief valve.

Filling the heater

Caution : Before plugging the water heater electric cord into an outlet, be sure that the system is completely charged with water and all air is removed. Before connecting the power, fill the tank and system with water and check for leaks. To be sure that all air is out of the water system, open the hot water faucets on your fixtures until constant water flows from them. Otherwise any air remaining in the tank will cause the water heater element to self destruct.

Filling the water heater:

1. Open the hot water faucet.
2. Open the cold water supply valve.
3. When continuous water flows out of the faucet, the tank is filled.
4. Close the hot water faucet.
5. Check entire system for leaks.

Electrical connections

To be certain that all of the air is out of the water heater, open the hot water faucet on your fixtures until constant water flows from them. If air remains in the tank, the element will be damaged when the electric cord is plugged in.

Connect the water heater to a grounded outlet.

The water heater is fitted with a power cord that is intended to plug into a grounded 110-120 V/AC receptacle. Adhere to all pertinent State and local codes. Install the correct size circuit breaker into the master panel. The WaiWela WM water heater was manufactured and wired in accordance with UL requirements.

The water heater is equipped with an overheat limiting device with a manual reset. Also known as the temperature high limit, this device has been factory installed to interrupt the power supply in the event of a thermostat failure. This water heater is designed for only 110-120V electrical service!

Do not connect to higher or lower voltage.

Failure to use proper voltage may result in personal injury and/or property damage. If the supplied electrical power cord is either damaged or not long enough, do not use an extension cord. Have a licensed electrician replace the power cord.

Instructions for use

Congratulations! You are now ready to use your water heater. Run the hot water at a nearby sink and evaluate the hot water temperature. Make any temperature adjustment using the section below:

Setting the thermostat:

The water heater is equipped with an adjustable thermostat that once set will automatically control water temperature. The red indicator lamp remains illuminated while the water is being heated. If the water in the tank is at the desired temperature the lamp will not be illuminated.

The temperature adjusting knob will increase the temperature by turning the knob clockwise and decrease the water temperature by turning the knob counter clockwise.

When not being used for a lengthy period of time, you can conserve energy by reducing the water temperature setting.

Setting the freeze protection:

When the water heater is not being used for an extended period of time and there is a risk of freezing, either unplug and drain the water heater or turn the thermostat knob to the snowflake position to guard against freezing. This position will keep the internal water temperature above the freezing point. See photo below.

Maintenance instructions

Do not attempt to repair this water heater yourself. Call a service person (plumber or electrician) for service assistance. Always unplug the power supply cord when the water is turned off or when servicing or draining the water heater.

Before calling for service, first confirm that the water heater is properly filled and that 110VAC power has not been interrupted.

Temperature adjusting knob in "**Freeze Protection**" position



Maintenance instructions cont.

Warning : Before servicing or cleaning the water heater, turn off the power switch and disconnect the power cord from the electrical outlet.

Note : For most maintenance operations, the water heater will be drained. In all cases before draining first turn off the power switch and then unplug power cord.

Draining and removing the water heater:

1. Unplug the water heater.
2. Open a hot water faucet to let hot water run out. Allow water to flow until water is no longer hot.
3. Turn off the cold water supply to the water heater.
4. Close the hot water faucet.
5. Disconnect the water heater from both the hot and cold water connections.
6. If possible siphon out remaining water.
7. Carefully detach the water heater from the wall.
8. Tilt the water heater to drain remaining water out of the heater.

Removing the heating element:

1. Turn off power supply, unplug water heater power cord and drain (see above).
2. Remove cover.
3. Remove all the line wires from the heating element.
4. Unscrew the heating element retaining nuts.
5. Remove the element.

Descaling the heating element :

Scale deposits can affect the heating capability of the element. Heavy scale can even cause the element to burn out. The element can be descaled chemically or manually.

1. Remove the heating element (see above).
2. To descale chemically, soak the heating element in white vinegar or other descaling solution and then rinse well with fresh water. (cont.)

Descaling the heating element cont.

3. To descale manually, let element dry and then using a non metallic brush similar to a tooth brush; brush the residue from the element. Avoid damaging the surface of the element.
4. Reinstall the element and gasket.
5. Refill tank with water before turning on the power to the water heater.

Replacing the heating element :

1. Unplug and drain the water heater (see prior instructions).
2. Remove heating element noting original positions of all connections.
3. Install new element with gasket making sure the new element and gasket are positioned correctly.
4. Tighten retaining nuts and make the wire connections to their original locations.

Changing the thermostat :

1. Turn off the power switch and unplug the water heater from the electric outlet.
2. Drain and remove the water heater. (see page 12)
3. Remove six screws retaining the bottom panel of the water heater and remove the panel.
4. Remove thermostat knob and unscrew two retaining screws. It may be necessary to pry the knob off of the thermostat spindle. Now remove front panel.
5. Disconnect the push-pull wire connectors on the thermostat noting which connector goes to which terminal. Terminals are marked.
6. Remove the thermostat probe from the well.
7. Install new thermostat, attach wires and tighten screws.

Thermostat



Resetting the high limit switch :

For various reasons the high limit safety shut off switch will occasionally shut the water heater down. This shut down will occur when water temperatures exceed 190°F. Power is automatically turned off to the heating element. The shut off device may activate as a result of a power outage or an electrical storm.

Note : Do not attempt to reset the high limit switch without first allowing the water heater to cool down the high temperature water inside the heater.

Warning : Do not tamper with the reset button to override overheating shut down.

1. Turn off the power switch and unplug the water heater from the electric outlet.
2. Drain and remove the water heater. (see page 12)
3. Remove six screws retaining the bottom panel of the water heater and remove the panel.

Locate the high limit reset button.

4. Depress the small red button in the center of the junction box, replace the bottom panel and place the water heater back into service.

Note: A lower temperature setting saves energy and reduces the risk of scalding.

Caution : Call a technician if the high limit needs to be reset frequently.

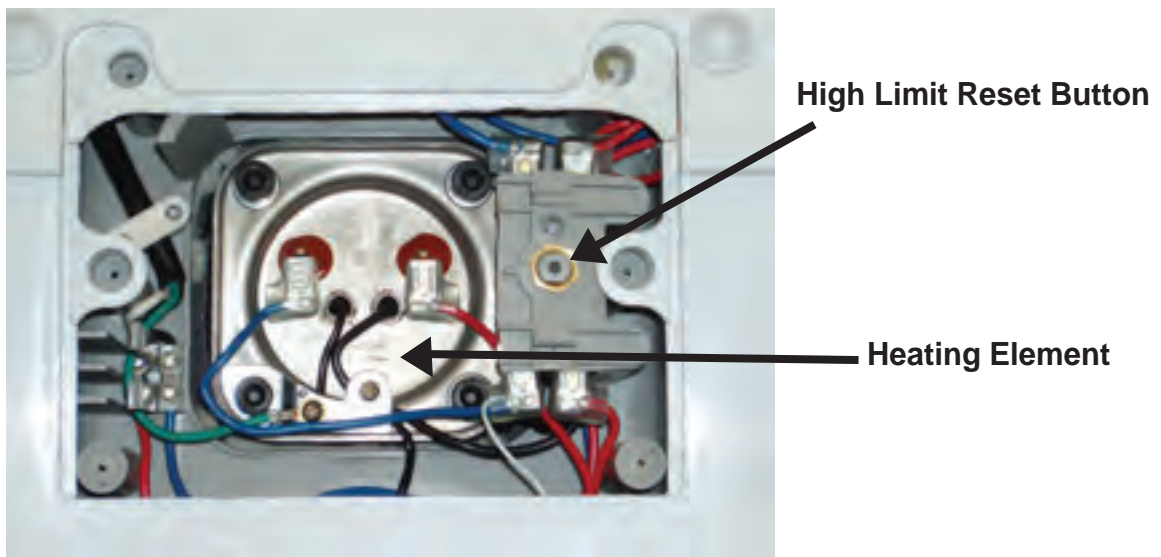

Troubleshooting

Problem: Water does not get hot

1. Make sure the power supply is on and working.
2. If light does not come on, check that the reset button is pushed in; follow steps from previous section.
3. If the indicator light is illuminated, but water temperature does not get hot at the sink, test for a plumbing crossover as follows; shut off cold water supply to water heater and open hot water tap. There should be no water flowing. Any continuous flow indicates a cross over which will effect the temperature and will need to be corrected.
4. If there is no crossover, then replace the heating element (see previous sections).

Problem: Indicator light not on

1. If the light does not come on, but water gets hot, check for faulty bulb.
2. Check reset button; follow steps from previous section.

Problem: Brown water

1. Brown or rusty water indicates a “spent” anode rod. Replace anode rod.

Problem: Odor in water

1. Smelly water could be due to an unusual reaction between local water and the heater’s anode rod. Check anode rod.

Problem: Water is too hot

1. Turn the temperature knob counter clockwise to a lower temperature setting. If temperature does not lower within 60 minutes, then replace thermostat.

Problem: Water is not hot enough

1. Under Instructions for Use, see “Setting the thermostat”.

Problem : Water is leaking

1. Turn off power switch and unplug water heater from 110 VAC outlet.
2. Check water fittings and T&P fitting in the top of the tank.
3. Remove cover and inspect heating element gasket.

WaiWela Mini Tank Water Heaters – Limited Six (6) Years Warranty

Coverage

Efficient Technology Sales, Inc. (hereinafter “ETS”) warrants this water heater to the Owner (hereinafter “Owner”) of the water heater at the original installation location against defects in material and workmanship for the periods specified below.

Warranty Period

1. When a failure of the inner tank of a WaiWela Mini Tank water heater, installed in a single family, residential application and exposed to normal usage (not including recirculating applications), occurs within six (6) years from the date of the original installation and is supplied with potable water, deemed not to be hard water, and such failure is proven to be a result of a defect in material or workmanship or within one (1) year if used as part of a recirculating application or in a non single family residential application, or with hard water, ETS will furnish to such owner a new water heater of the then prevailing comparable model.
2. If any component part (other than the inner tank) is proven to be defective in material or workmanship within two (2) years from date of original installation in a single family, residential application used with potable water deemed not to be hard water or within one (1) year if used as part of a recirculating system, or with hard water, or if used in other than a single family residential dwelling, ETS will furnish the Owner with a replacement of the defective part(s).
3. Verification of Date of Original Installation- When Owner can not verify or document the original date of installation, the warranty period begins on the date of manufacture marked on the tag affixed to the water heater.

Exclusions

1. This limited warranty shall be the exclusive warranty made by the manufacturer and is made in lieu of all other warranties, expressed or implied (whether written or oral), including, but not limited to, warranties or merchantability and fitness for a particular purpose.
2. The Manufacturer shall not be liable for any incidental, consequential, special or contingent damages or expenses arising, directly or indirectly, from any defect in the water heater or the use of the water heater.

Exclusions Cont.

3. The Manufacturer shall not be liable for any water damage arising, directly or indirectly, from any defect in the water heater component part(s) or from its use.
4. Manufacturer shall not be liable under this warranty if:
 - a) The water heater or any of its component parts has been subject to excessive water pressure, misuse, abuse, alteration, neglect or accident, or
 - b) The water heater has not been installed in accordance with the applicable local plumbing, electrical and/ or building code(s) and/or regulation(s), or
 - c) The water heater has not been installed in accordance with the printed manufacturer's instructions, or
 - d) The water heater is not continuously supplied with potable water, otherwise described as dry firing
 - e) The water heater is exposed to conditions resulting from floods, earthquakes, winds, fire, lightning or circumstances beyond the control of the manufacturer
 - f) The water heater is installed by non-qualified personnel.
5. The owner and not the Manufacturer or his agent/representative shall be liable for and shall pay for all field charges for labor or other expenses incurred in the removal and/or repair of the water heater or any expense incurred by the Owner in order to repair the water heater.

Some states do not allow the exclusion or limitation of incidental or consequential damages, so the above limitation or exclusion may not apply to you. This warranty gives you specific legal rights and you may also have other rights which may vary from state to state.

Important : Owner should retain this document.

Note : Most tank water heaters eventually leak. Your WaiWela quality water heater should be installed in such a manner that if it should leak, the resulting flow of water will not cause damage to the area in which it is installed.

Schematic Disassembly
WM-1.0/WM-2.5/WM-4.0/WM-6.0

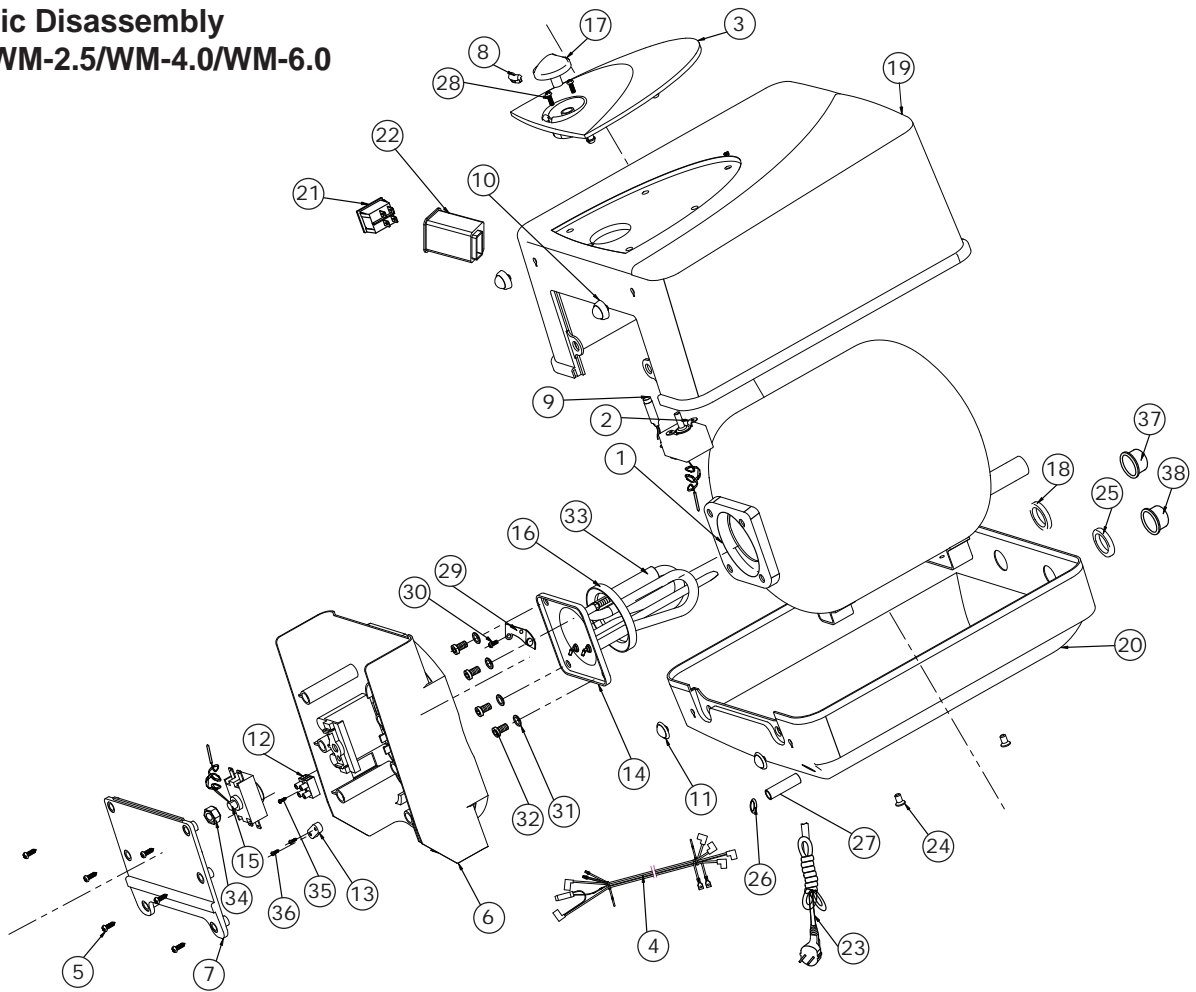

Parts List WM-1.0/WM-2.5/WM-4.0/WM-6.0

No.	Name of Part	Qty.
1	Tank Component	1
2	Thermostat	1
3	Temp. Adjust Panel	1
4	Inside Wiring Assembly	1
5	Cross Screws	6
6	Inside Cover	1
7	Bottom Cover	1
8	Indicate Light Cover	1
9	Power Indicate Light	1
10	Support 1	2
11	Support 2	2
12	Thermal Block	1
13	Wire Press Plate	1
14	Heating Element	1
15	Over Heat Limiter	1
16	Heating Element Gasket	1
17	Temp. Control Knob	1
18	Red Circle	1
19	Front Cover	1

No.	Name of Part	Qty.
20	Back Cover	1
21	Power Switch	1
22	Power Switch Box	1
23	Power Cord	1
24	Screw	2
25	Blue Circle	1
26	Power Cord Sheath	1
27	Power Cord Sheath Press	1
28	Cross Screw	2
29	Connect Plate	1
30	Cross Screw	1
31	Flat Gasket	4
32	Copper Screw	4
33	Aluminum Anode Rod	1
34	Bolt	1
35	Cross Screw	1
36	Cross screw	2
37	Red Thread Cover	1
38	Blue Thread Cover	1

How the owner can secure service assistance or make a warranty claim

1. Owner should contact the dealer who sold the water heater covered by this warranty or
2. Owner should submit the warranty claim directly to ETS at the address listed below, and they will arrange for the handling of the claim.
3. Whenever a warranty service request is made, be sure to include Proof of Purchase, the water heater model number and the date of manufacture, date of installation, Dealer's name and the watts and voltage.
4. When returning the water heater or component part(s), they must be individually tagged and identified with the Returned Goods Authorization # issued by ETS and shipped prepaid to ETS at the address below.

Efficient Technology Sales, Inc.

5350 Joliet Street

Denver, CO 80239

T: 800.605.6542

P: 303.339.4900

F: 303.339.4909

www.waiwela.com



