

**ECOSMART TROUBLE SHOOTING GUIDE
MODELS ECO18-ECO27**



eco
SMART™
GREEN ENERGY PRODUCTS

THIS STEP BY STEP TROUBLE SHOOTING GUIDE IS DESIGNED FOR THE INSTALLER IF ANY ISSUES ARISE WITH TANKLESS WATER HEATER.

YOU CAN ALSO VIEW A TROUBLE SHOOTING VIDEO AT OUR WEB SITE.

ecoSMARTUS.COM

Step by Step Trouble Shooting Guide

This Guide is for Use by Qualified Electrical Professional

This Trouble Shooting Guide will take you through simple steps to determine any problems or issues with unit. This Guide takes you through a sequence of steps that MUST be followed. Skipping around might not determine the exact problem, therefore you MUST follow the sequence.

All Ecosmart units have a simple design and are very easy to check with the use of a MULTI CLAMP METER able to measure both Voltage and Amperage.

Below is a picture of an open view of an ECOSMART TANKLESS WATER HEATER -3 chamber unit.

Follow the steps as described and write down the readings /results on the back pages so when contacting Technical Support you have the information in hand.



ECO 18 = 2 HEATING ELEMENT (2 CHAMBER HEAT EXCHANGER)
ECO 21-27 = 3 HEATING ELEMENT (3 CHAMBER HEAT EXCHANGER)

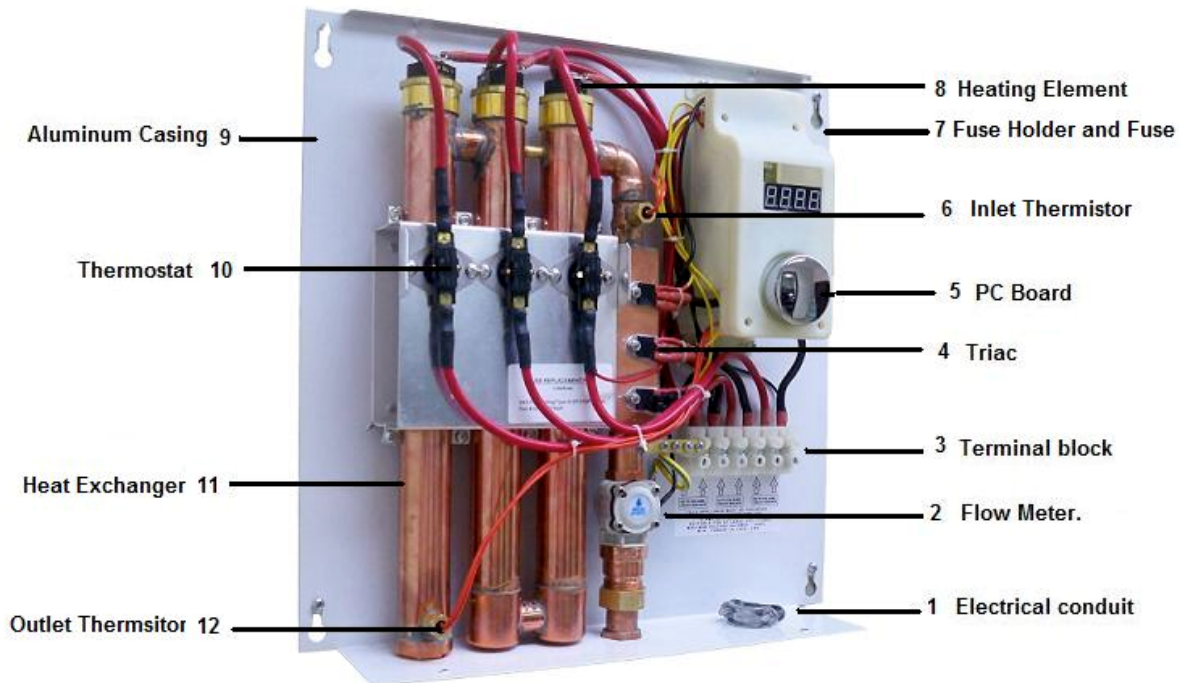

You can contact our Technical Support at 877-474-6473 Mon-Fri 8:00 am—5:00 pm. EST or visit our web site at www.ecosmartus.com Go to Customer Service and Select Tech Support Video to view this step by step manual in video form.

DISCONNECT ALL POWER TO UNIT BEFORE REMOVING COVER.

STEP 1 ELECTRICAL CONNECTION

MODELS 21-24-27 ARE SUPPLIED WITH A 6 PRONG TERMINAL BLOCK MARKED (L1 L1) (L2 L2) (L3 L3). MODEL 18 IS SUPPLIED WITH A 4 PRONG TERMINAL BLOCK MARKED (L1 L1) (L2 L2)

EACH ONE OF THE CONNECTION SETS MUST BE CONNECTED TO AN INDEPENDENT DOUBLE POLE 40 AMP BREAKER. L1-L1 GOES TO ONE 40 AMP DOUBLE POLE BREAKER, L2-L2 GOES TO ANOTHER 40 AMP DOUBLE POLE BREAKER AND L3-L3 TO ANOTHER 40 AMP DOUBLE POLE BREAKER.

YOU MUST ENSURE THE SET OF WIRES FROM EACH LEG ARE NOT CROSSED AT THE BREAKERS OTHERWISE THE UNIT WILL NOT FUNCTION AS DESIGNED. IN ORDER TO MAKE SURE THE WIRING IS CONNECTED CORRECTLY PERFORM THE FOLLOWING TEST.

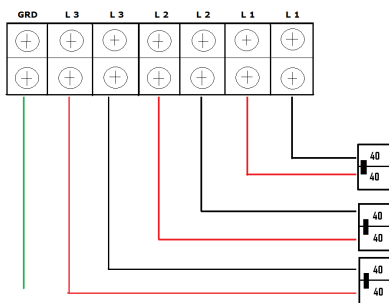

DISCONNECT ALL BREAKERS AT THE SERVICE PANEL. ONCE ALL BREAKERS HAVE BEEN DISCONNECTED MEASURE THE VOLTAGE GOING TO EACH ONE OF THE SETS (L1 L1) (L2 L2) (L3 L3) ALL SHOULD READ 0 VOLTAGE.

NOW- TURN ON 1 BREAKER, IT DOES NOT MATTER WHICH ONE. ONCE ONE BREAKER HAS BEEN TURNED ON, USING YOUR VOLTME-

TER PLACE ONE PROBE ON L1 AND THE OTHER PROBE ON THE OTHER L1, MEASURE ACROSS (L1-L1) YOU SHOULD GET A READING OF 208-240V. DO THE SAME FOR (L2-L2) AND (L3-L3)

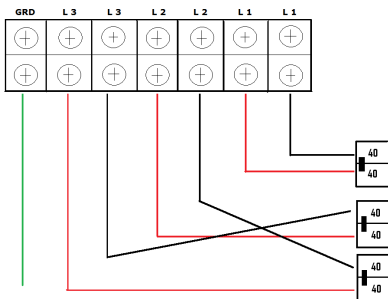

IF YOU MEASURE VOLTAGE ACROSS ONE OF THE LEGS IN A SET AND VOLTAGE IN ANOTHER LEG OF ANOTHER SET, THEN YOUR WIRES AT THE BREAKERS ARE CROSSED AND MUST BE CORRECTED. EXAMPLE- L1-L1 READS NO VOLTAGE, BUT L1-L2 GIVES YOU VOLTAGE READING, THEN YOUR WIRES AT THE BREAKERS ARE CROSSED AND MUST BE FIXED.

PERFORM THIS VOLTAGE READING ON ALL LEGS OF TERMINAL BLOCK BOTH AT THE BOTTOM AND TOP OF TERMINAL BLOCK TURNING ON 1 BREAKER AT A TIME.

IF POWER GOING TO THE UNIT IS NOT CORRECT, THE UNIT WILL NOT OPERATE CORRECTLY, SO IT IS IMPORTANT TO PERFORM THIS TEST FIRST, BEFORE PROCEEDING .

THE PROBLEM MIGHT NOT BE AT THE UNIT, BUT AT YOUR ELECTRICAL PANEL , OR BREAKERS.

NOW THAT WE HAVE VERIFIED THAT THE ELECTRICAL CONNECTIONS ARE CORRECT, LETS CONTINUE.

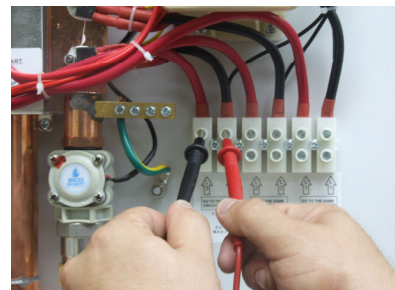
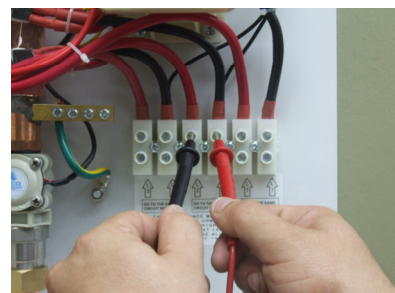
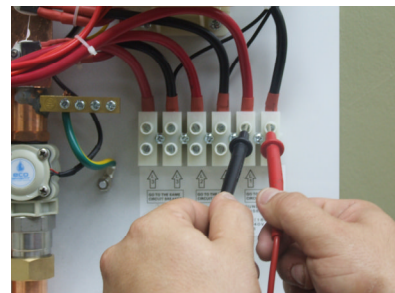
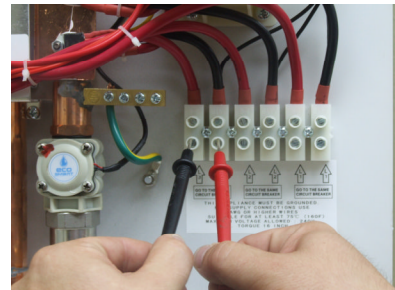
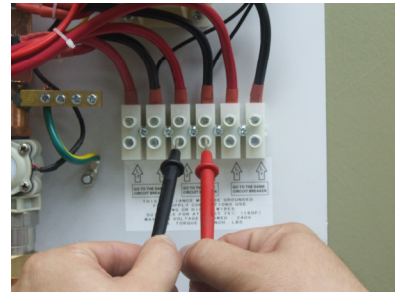
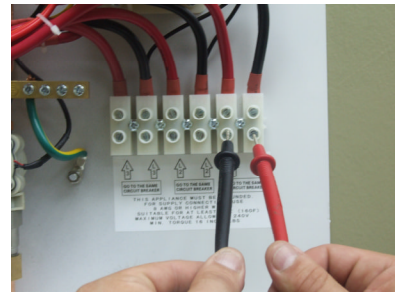

STEP 2 VERIFYING POWER TO ELECTRONIC BOARD

THE FOLLOWING STEP WILL VERIFY POWER IS GOING TO THE BOARD.

TURN OFF ALL POWER TO THE UNIT. REMOVE THE 4 SCREWS FROM THE PLASTIC BOARD PROTECTOR AND REMOVE THE COVER.

TURN ON ALL BREAKERS. WHEN BREAKERS ARE TURNED ON THE LED DISPLAY ON THE UNIT WILL TURN ON FOR A COUPLE OF SECONDS AND THEN TURN OFF. THIS INDICATES THAT THERE IS POWER GOING TO THE BOARD. THE LED DISPLAY WILL FROM THEN ON ONLY TURN ON AND DISPLAY THE TEMPERATURE SETTING ON THE CONTROL WHEN HOT WATER IS DEMANDED OR IN USE, OTHERWISE THE LED DISPLAY WILL REMAIN OFF. IF THE BREAKERS ARE TURNED ON AFTER BEING DISCONNECTED AND NO LED DISPLAY LIGHT TURNS ON FOR A COUPLE OF SECONDS, THERE MIGHT BE A BURN FUSE OR OTHER ELECTRICAL PROBLEM WITH THE BOARD. LET'S PROCEED TO TEST THE BOARD.

AT THE TOP OF THE ELECTRONIC BOARD THERE ARE A SET OF BLUE TERMINAL BLOCKS. THESE ARE THE CONNECTIONS FROM THE UNIT TO THE ELECTRICAL BOARD.

THERE IS ALSO AN IN LINE FUSE PROTECTION BEFORE THE BOARD. IF THE FUSE IS BAD THE BOARD WILL HAVE NO POWER AND THEREFORE THE UNIT WILL NOT OPERATE.

RED = FUSE

BLACK = POWER FROM TERMINAL BLOCK

YELLOW = POWER FROM TRIAC

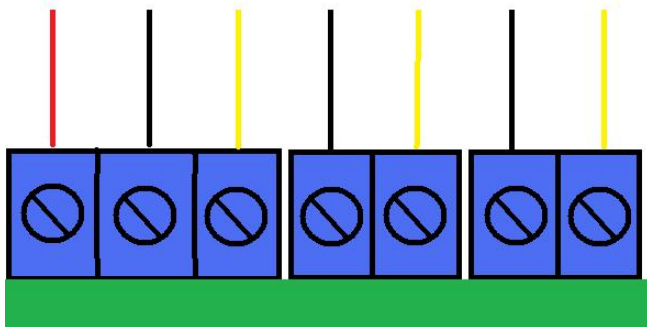

CHECK THE FUSE USING YOUR VOLT METER. PLACE ONE PROBE ON THE FARTHEST LEFT TERMINAL BLOCK THAT HAS THE **RED** FUSE WIRE CONNECTION AND THE OTHER PROBE TO GROUND. YOU SHOULD GET A VOLTAGE READING OF 110-120V, IF THERE IS NO READING THE FUSE MUST BE REPLACED.

YOU CAN CONTINUE TO CHECK THE REST OF THE ELECTRICAL CONNECTIONS GOING INTO THE BOARD, VERIFY THAT THERE IS VOLTAGE READINGS ON ALL TERMINAL LINES COMING INTO THE BOARD. THIS IS DONE BY PLACING ONE PROBE OF YOUR VOLT METER ON THE TERMINAL AND THE OTHER TO GROUND. DO NOT MEASURE ACROSS FROM LINE TO LINE OR YOU WILL SHORT CIRCUIT COMPONENTS ON THE BOARD. ALWAYS USE OR CONNECT ONE PROBE TO THE TERMINAL AND THE OTHER MUST BE GROUNDED.

FAILURE TO FOLLOW THESE PROCEDURES WILL DAMAGE BOARD, THIS TYPE DAMAGE IS NOT COVERED UNDER THE LIMITED LIFETIME WARRANTY. SO IF NOT SURE WHAT TO DO OR HOW TO DO, CONTACT OUR TECH SUPPORT DEPT.

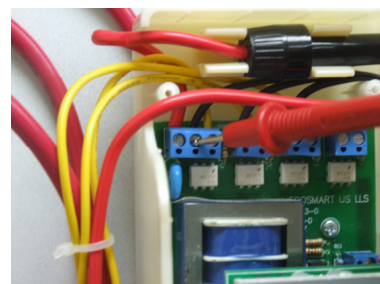
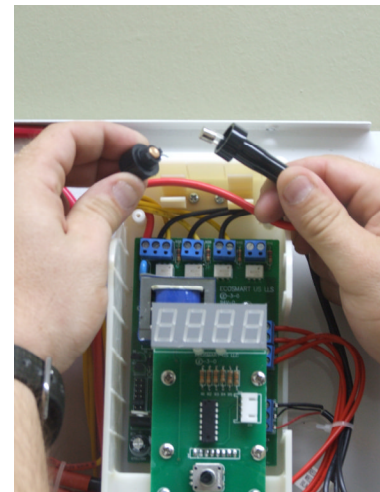
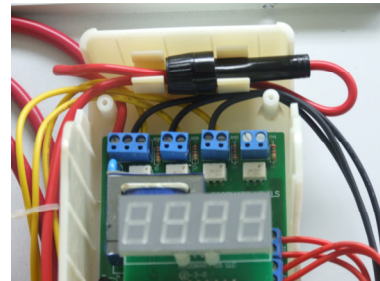
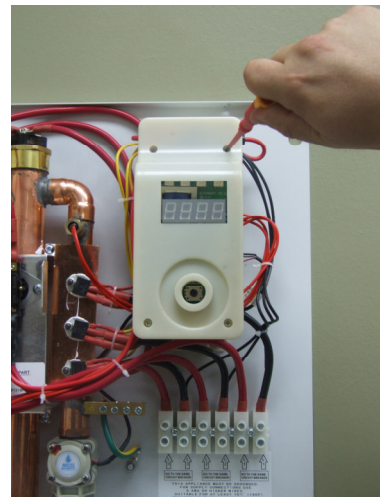

STEP 3 VERIFYING SAFETY THERMOSTATS

THE FOLLOWING STEP WILL VERIFY POWER IS GOING THROUGH THE SAFETY THERMOSTATS.

IF A THERMOSTAT IS DAMAGED THE HEATING ELEMENT WILL NOT FUNCTION OR HEAT UP.

TO VERIFY THE THERMOSTATS YOU NEED TO HAVE THE BREAKERS TURNED ON. YOU WILL PERFORM THIS TEST WITH YOUR VOLT METER.

THIS TEST WILL VERIFY THAT ELECTRICAL POWER IS GOING TO THE BOTTOM AND ACROSS THE THERMOSTAT.

USING YOUR VOLT METER YOU NEED TO PLACE ONE PROBE AT THE BOTTOM METAL PART OF THE THERMOSTAT AND THE OTHER PROBE NEEDS TO BE GROUNDED.

THEN PERFORM THE SAME TEST ON THE TOP PART OF THE THERMOSTAT.

ALL READING ON THIS TEST SHOULD BE IN THE 110-115V RANGE.

THIS TEST MUST BE PERFORMED ON ALL THERMOSTATS, ONE BY ONE.

AGAIN, YOU MEASURE CURRENT GOING INTO BOTTOM OF THERMOSTAT TO GROUND AND THEN THE TOP PART OF SAME THERMOSTAT TO GROUND TO ENSURE THE THERMOSTAT IS IN GOOD WORKING CONDITION.

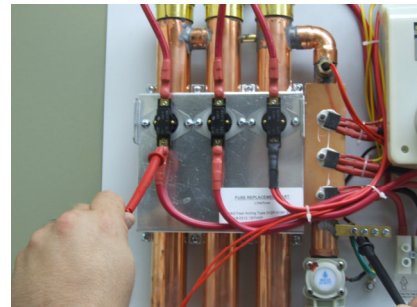
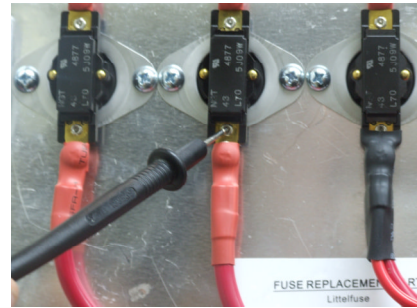
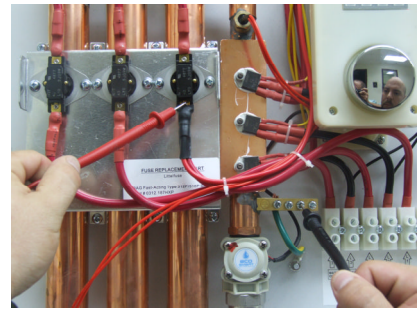

STEP 4-A VERIFYING HEATING ELEMENTS

THE FOLLOWING STEP WILL VERIFY THE HEATING ELEMENTS ARE WORKING CORRECTLY.

THE HEATING ELEMENTS WILL ONLY DRAW VOLTAGE WHEN HOT WATER IS BEING USED AND ONLY THE VOLTAGE THAT IT NEEDS BASED ON WHERE YOU HAVE YOUR DIGITAL TEMPERATURE SETTING.

WHEN HOT WATER IS DEMANDED THE ELEMENTS WILL INSTANTLY DRAW VOLTAGE. THE HEATING ELEMENTS WORK IN SERIES WHICH MEANS THAT THE FIRST ELEMENT LOCATED ON THE INLET SIDE OF THE UNIT WILL BE THE FIRST ONE TO DRAW POWER, THEN THE MIDDLE ONE AND FINALLY THE ONE ON THE OUTLET SIDE.

IN ORDER FOR THE SECOND ELEMENT TO DRAW POWER THE FIRST ELEMENT MUST BE DRAWING 100% CAPACITY. AND FOR THE THIRD TO DRAW THE SECOND MUST BE DRAWING 100% CAPACITY.

THERE ARE TWO RED WIRES CONNECTED TO THE TOP OF THE ELEMENT. IN ORDER TO CHECK IF THE ELEMENT IS WORKING YOU MUST TURN ON A HOT WATER TAP. WE SUGGEST THAT YOU RUN THE TUB OR A SHOWER AND SINK. THIS WAY ALL ELEMENTS WILL DRAW VOLTAGE AND CAN BE CHECKED.

ONCE YOU HAVE WATER RUNNING THROUGH THE UNIT THE LED DISPLAY WILL LIGHT UP AND DISPLAY THE TEMPERATURE SETTING ON THE UNIT. USING YOUR VOLT METER-PLACE ONE PROBE ON ONE SCREW AND THE OTHER PROBE ON THE OTHER SCREW LOCATED ON THE TOP OF THE ELEMENT. CHECK WHAT VOLTAGE YOU ARE DRAWING. YOU NEED TO START ON THE FIRST ELEMENT (FARTHEST RIGHT WHEN FACING UNIT) SINCE THE ELEMENTS ACTIVATE IN SERIES).

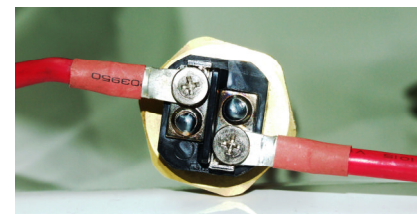

STEP 4-CONTINUED

WHEN MEASURING VOLTAGE ACROSS THE TOP OF THE ELEMENTS YOU WILL GET A VOLTAGE READING.

REMEMBER- YOU MUST HAVE WATER RUNNING IN ORDER FOR THE ELEMENTS TO ACTIVATE AND DRAW POWER.

IF YOUR LED DISPLAY IS LID AND YOU HAVE WATER RUNNING THROUGH THE UNIT AND HAVE 0 VOLTAGE READING WHEN MEASURING WITH PROBES ON EACH SCREW -PERFORM THE SAME TEST, BUT THIS TIME PLACING ONE PROBE ON ONE SCREW AND THE OTHER PROBE TO GROUND. DO THE SAME ON THE OTHER SCREW. IF YOU ARE GETTING VOLTAGE READINGS WHEN TESTING ON ONE SCREW TO GROUND BUT NO VOLTAGE WHEN MEASURING FROM SCREW TO SCREW YOUR ELEMENT MIGHT BE BAD AND MUST BE REPLACED.

NOW- REMEMBER YOU MUST HAVE SEVERAL HOT WATER APPLICATIONS RUNNING SUCH AS A TUB, SHOWER AND SINKS TO ENSURE THE UNIT FORCES THE OTHER ELEMENTS TO DRAW POWER.

STEP 4-B

THIS TEST IS TO MEASURE AMPERAGE DRAW ON EACH ELEMENT. THIS IS DONE BY USING THE CLAMP PORTION OF THE METER AND CLAMPING AROUND THE RED WIRE THAT COMES FROM THE TOP OF THE BLACK ROUND THERMOSTATS LOCATED ON THE SILVER PLATE TO THE HEATING ELEMENT.

WHILE WATER IS RUNNING GET THE AMPERAGE DRAW FOR EACH ELEMENT. AGAIN FROM RIGHT TO LEFT SINCE ELEMENTS ACTIVATE IN SERIES. THE FIRST ELEMENT WILL DRAW FULL AMPERAGE BEFORE THE SECOND ELEMENT STARTS TO DRAW ANY AMPERAGE.

IT IS IMPORTANT TO FOLLOW THESE STEPS AND WRITE DOWN THE READINGS/RESULTS.

THESE STEPS WILL ASSIST IN A QUICK RESOLUTION TO ANY ISSUES YOU MIGHT HAVE WHEN CONTACTING OUR TECHNICAL SUPPORT DEPARTMENT.

THE LAST PAGE IS DESIGNED TO DOCUMENT ALL READINGS

SHOULD YOU HAVE ANY QUESTIONS BEFORE , DURING OR AFTER INSTALLATION YOU CAN CONTACT OUR TECHNICAL SUPPORT DEPARTMENT TOLL FREE AT 877-474-6473

Email: info@ecosmartus.com

Or visit our web site at

www.ecosmartus.com

and view a step by step video on trouble shooting.

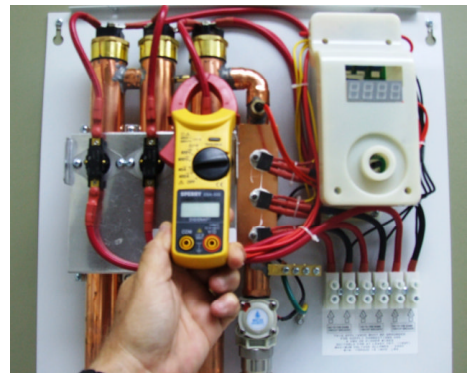

HOW TO SET AND SELECT YOUR TEMPERATURE SETTING.

DIFFERENT THAN A STORAGE TANK TYPE WATER HEATER THAT YOU NORMALLY SET THE THERMOSTAT TEMPERATURE BETWEEN 130°F-140°F, SO YOU DO NOT RUN OUT OF HOT WATER TOO FAST WHICH CAN CAUSE HOT WATER SCALDING AND FORCES YOU TO USE MORE WATER BY HAVING TO MIX COLD WATER TO ATTAIN YOUR COMFORTABLE SHOWER OR HOT WATER USAGE TEMPERATURE. THE ECOSMART GUARANTEES YOU UNLIMITED HOT WATER AND THEREFORE IT IS NOT NECESSARY TO SET IT AT A HIGH TEMPERATURE SETTING.

THE CONCEPT BEHIND THE DIGITAL MODULATING TECHNOLOGY IS TO NOT ONLY SAVE ENERGY , BUT ALSO WATER AND HERE IS HOW TO DO IT...

- **U.S. DOE**-Lowering the thermostat on your water heater by 10°F can save you between 3%-5% in energy costs. Most households only require a water heater thermostat setting of 120°F, or even 115°F.

THIS STEP SHOULD BE PERFORMED BY THE PERSON IN THE HOUSEHOLD WHO LIKES THE HOTTEST SHOWER.

ONCE THE UNIT HAS BEEN PROPERLY INSTALLED—SET THE THERMOSTAT TO 115°F (TO CONVERT DISPLAY TO CELCIUS PUSH AND HOLD BUTTON FOR 3 SECONDS).

RUN YOUR SHOWERHEAD USING JUST YOUR HOT WATER CONTROL HANDLE. LET THE WATER RUN UNTIL YOU FEEL THE HOT WATER. IF THE TEMPERATURE IS TO WHERE YOU HAVE TO MIX OR USE YOUR COLD WATER HANDLE TO ATTAIN A LOWER MORE COMFORTABLE TEMPERATURE THEN YOUR SETTING ON THE UNIT CAN BE LOWERED.

BY SELECTING THE APPROPRIATE TEMPERATURE SETTING ON YOUR TANK-LESS WATER HEATER YOU WILL NOT ONLY HAVE GREATER ENERGY SAVING, BUT ALSO WATER SAVINGS NOT TO MENTION THE SAFETY AS IT PERTAINS TO HOT WATER SCALDING.

THIS STEP IS DONE AT THE TIME OF INSTALLATION. THERE IS NO NEED TO MAKE ADJUSTMENTS DURING WINTER OR SUMMER MONTHS SINCE OUR SELF MODULATING TECHNOLOGY RECOGNIZES INLET TEMPERATURE CHANGES AND ADJUST ITSELF ELECTRONICALLY.

YOU JUST SET IT AND FORGET IT...

U.S. CONSUMER PRODUCT SAFETY COMMISSION -Each year, approximately 3,800 injuries and 34 deaths occur in the home due to scalding from excessively hot tap water. The majority of these accidents involve the elderly and children under the age of five. The U.S. Consumer Product Safety Commission (CPSC) urges all users to lower their water heaters to 120 degrees Fahrenheit. In addition to preventing accidents, this decrease in temperature will conserve energy and save money.

Most adults will suffer third-degree burns if exposed to 150 degree water for two seconds. Burns will also occur with a six-second exposure to 140 degree water or with a thirty second exposure to 130 degree water. Even if the temperature is 120 degrees, a five minute exposure could result in third-degree burns.

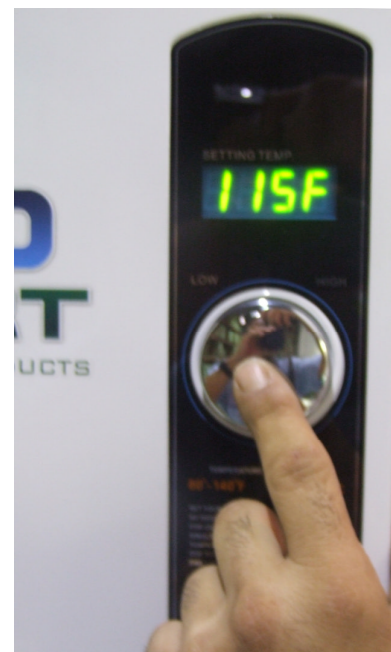

VOLTAGE AT TERMINAL BLOCK

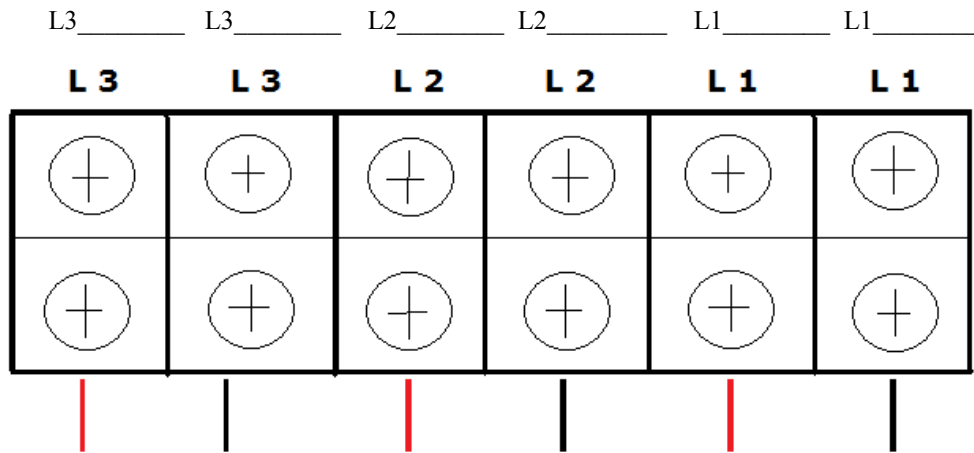

VOLTAGE TO ELECTRONIC BOARD

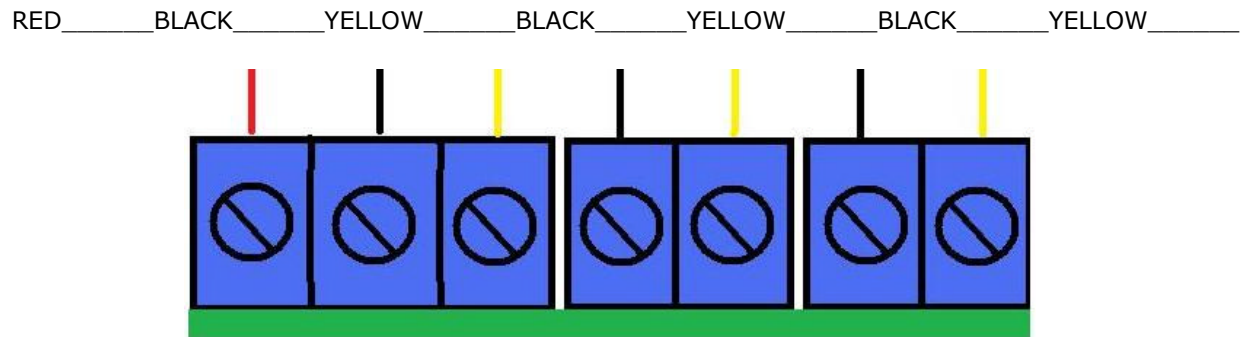

VOLTAGE AT THERMOSTATS

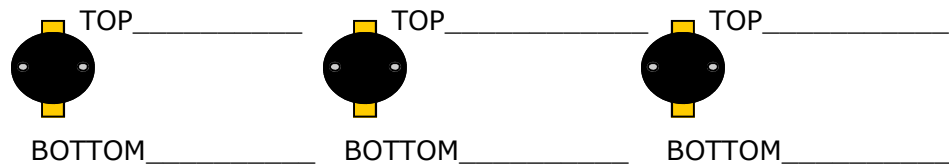

VOLTAGE AT HEATING ELEMENTS

