

THE CAVE DESCRIPTION



2-3 PERSON TENT
IGD/GEODESIC STRUCTURE
MULTI CHAMBER SAFETY
ONE-PUMP SYSTEM
WEIGHT 4.8 KG



PAT. NR. 10 2010 050 485

HPT THE CAVE



GERMAN 中国人 ESPAÑOL ITALIAN 한국인 SVENSKA FRANÇAIS
PORTUGUÊS แบบไทย NORSK 日本語 ENGLISH يبرع DANSK

[HTTP://EN.HEIMPLANET.COM/PRODUCT-MANUAL/THECAVE](http://en.heimplanet.com/product-manual/thecave)

HEIMPLANET STANDS
FOR TRAVELLING, NEW IDEAS
AND THE DRIVE TO ACCOMPLISH
THINGS IN A CREATIVE WAY.

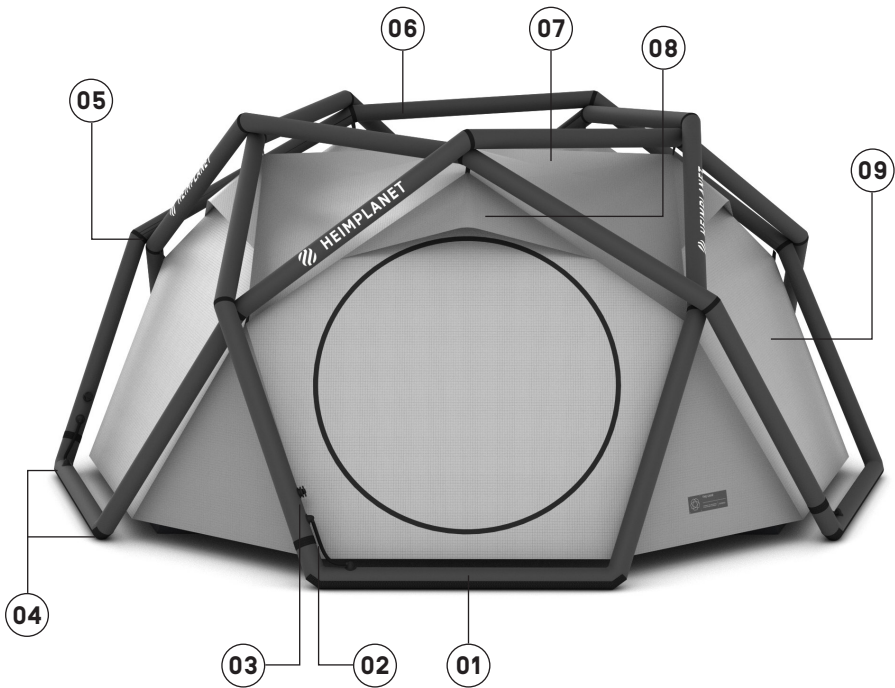



The **Inflatible Diamond Grid (IDG)** is a self-supporting air frame inspired by the molecular structure of a diamond. Its design principle follows that of a geodesic dome. What sets it apart is its high stability and its excellent surface-area-to-volume ratio.

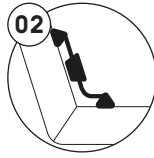

The **patented Multi Chamber Safety System** allows the entire air frame (IDG) to be inflated in a single step. The inflated frame can then be divided into five separate chambers with the one-pump connectors, assuring stability even if some parts are damaged.



The IDG features four **2-in-1-valves**, each with two closures: a one-way valve for quick and simple inflation of the air frame and a large opening for easy deflation. So pitching and taking down the tent is nearly effortless.

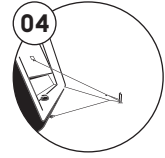

Tensioning options: The Cave comes with five side guy line points to firmly secure all four corners while keeping the flysheet and inner tent safely separated. This ensures that The Cave stays perfectly steady and dry - even when it's stormy and pouring outside!

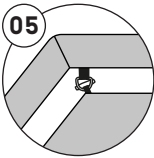

Flexibility: The tent is designed so that the frame, the flysheet and inner tent can be pitched in a single step (inflation). The flysheet and inner tent can also be used separately.

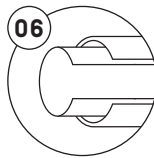

The **air beams** feature a tough, double-layer construction. An airtight TPU (thermo-plastic polyurethane) bladder provides consistent air pressure over long periods of time. The outer sleeve is made of an extra-strong polyester fabric, ensuring outstanding rigidity and durability.

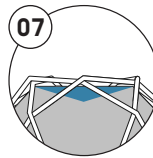

The **Gear Loft** can be used to store items under the roof of the inner tent, or to hold a lamp to create soft, diffused light inside the tent.

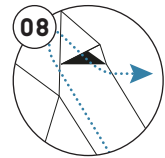

Upper ventilation: Five closable air vents ensure perfect, upward air circulation - even in the worst conditions.

FIRST ASSEMBLY

When assembling the The Cave for the first time, the frame, the flysheet and inner tent are connected to each other. Once the tent has been put together, there is no need to repeat the first assembly. From then on, the frame, flysheet and inner tent can be unpacked and inflated to how they were before - the tent "sets itself up".

THE CAVE THE THREE COMPONENTS

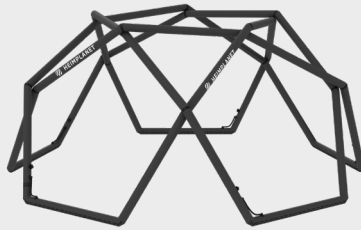

The inflatable airframe or IDG (Inflatible Diamond Grid) is the primary structure of the tent.

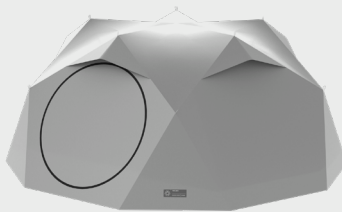

The flysheet protects against wind and weather.

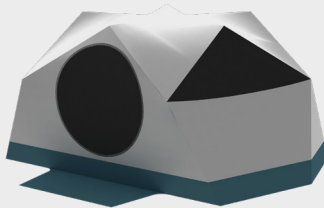

The inner tent is made of a sturdy, waterproof floor material and breathable nylon fabric that ensures an ideal indoor climate.

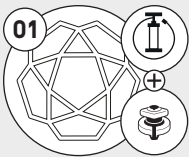

01 SPREAD OUT AIRFRAME

Spread out the inflatable airframe, and gently fill it with air until it is erected.

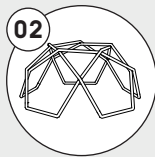

02 ARRANGE STRUTS

If the struts are twisted too tightly, simply let out a little air and correct it.

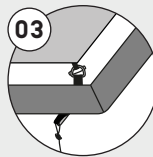

03 INNER TENT TO GROUND STRUTS

Position the inner tent under the erected airframe and only secure the ground struts for now.

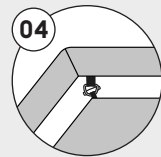

04 FLYSHEET TO TOP STRUTS

Place the flysheet between the inner tent and airframe, and then secure the upper struts.

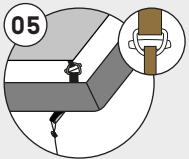

05 FLYSHEET TO GROUND STRUTS

Secure the flysheet to the floor struts. For this follow the colour code.

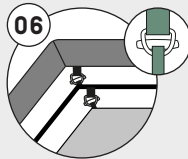

06 FLYSHEET TO INNER TENT

Mount the inner tent inside the flysheet. For this follow the colour code.

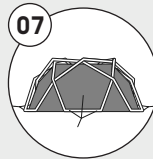

07 READY FOR USE

Once you have completed the first assembly, the components can stay joint. Set-up is easy from now on: Spread out, pump up, welcome home!

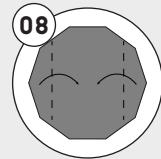

08 TAKE DOWN

After first assembly, the tent can be rolled up and packed away in one piece. A description can be found online.

SET-UP

Once the initial setup is complete, all you need to do from now on is the very simple and fast setup. This is done in no time!

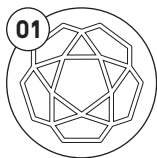

PREPARE

Unpack tent and accessories. Lay out flat on the ground.



CLOSE (x5)

Close all five valves.



OPEN (x1)

Connect the pump to one of the adapters.

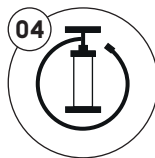

PUMP

Inflation is quick - tent pitches itself.



CLOSE (x1)

Disconnect the pump and make sure all valves are properly closed.



SECURE (x5)

Use the punch clips to separate the air beams

★

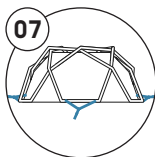

PEG GROUND STRUTS

First, lightly anchor the tent to the five ground struts. In **VERY WINDY CONDITIONS**, this step can be done earlier - no other tent is as easy to set up in the wind as this one!

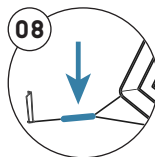

TIGHTEN

Finally, tighten all guyings so that the tent is firmly fixed.

★

SECURE CLIPS

The clips in the neoprene sleeve and are easy to use. They can be felt and operated with the hands through the protecting neoprene covers.

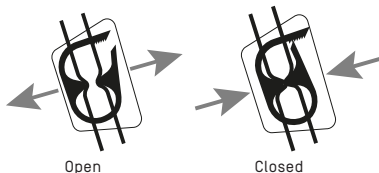

TAKE DOWN

For take down, you can pack the three assembled components, frame, flysheet and inner tent, together in one piece and pack them away. It is thus easily made available again for future use. Remember to take all items out of the tent and make sure it is dry. Let it air dry at home if necessary to prevent from mold.



RELEASE (x5)

Release the five punch clips.

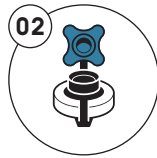

OPEN (x5)

Open all five valves.

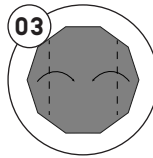

FOLD

Fold the tent in one perimeter (including the frame, flysheet & inner tent). Push out the excess air in each fold.

★

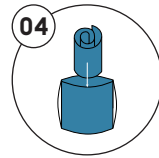

ROLL UP & PACK

Roll up the correctly folded tent and press out the excess air. Insert the rolled up tent into the bag and compress with the straps.

★

TIP!

If you fold the tent correctly, it fits perfectly into the packsack. To get the airframe as deflated as possible, roll the tent up and down several times at the end, so that a little more air is squeezed out with each roll up. This is how you compress the tent to a minimum pack size.

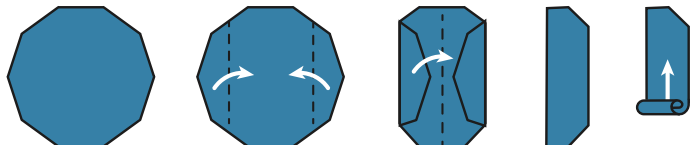

ADVANCED SETUP

The Cave's design gives its user great flexibility over several aspects of the tent - in especially stormy conditions you can reinforce the tent by using guy lines, while the inner tent can be used with a range of ventilation options to easily regulate the temperature, whatever the weather.

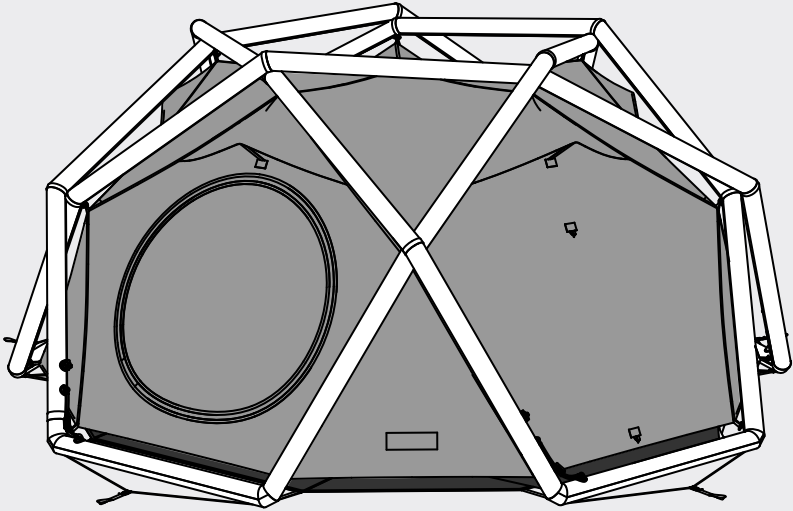

TENSIONING POINTS OVERVIEW

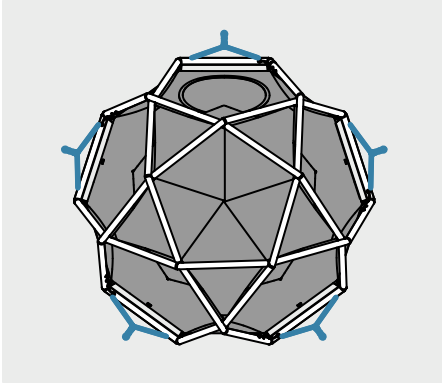

The ground struts have the tensioning cords pre-attached. These are part of the general set up for normal weather conditions.

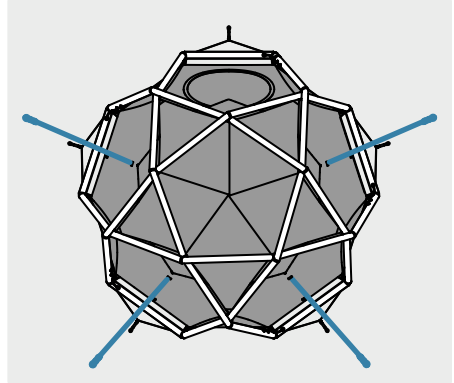

The additional guy lines can be attached at four sides of the flysheet if necessary.

TENSIONING OPTIONS STORMY WEATHER CONDITIONS

The Cave uses 4x additional guy line points to firmly secure the tent's position while keeping the flysheet and inner tent safely separated. This ensures that The Cave stays perfectly dry and steady – even when it's stormy and pouring outside!

To install the guy lines, simply connect one toggle to the two D-rings on the sides of the flysheet (1A & 1B). Now peg the adjustable part of the guy line into the ground (02). With the help of the cord adjusters (03), you can easily increase or decrease tension to the tent.

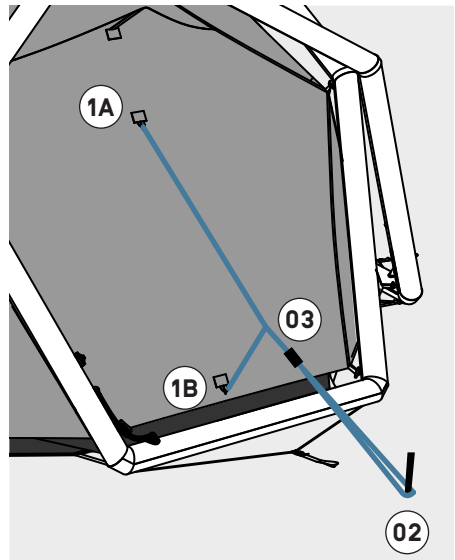

CAUTION!

Close the tent doors before tensioning to avoid extra stress on the fabric and the zippers.

REPAIR

The IDG is made of especially robust materials. However, if the outer sleeve or inner bladder is damaged, you can replace or patch it just as you would a flat tire on a bike. If the bladder is punctured, it can easily be removed through the repair opening at the end of each strut.

01 LOCATE THE REPAIR OPENING

You can find the repair opening at the end of each strut. Open the Velcro to access to the inner TPU bladder.

★

02 CONNECTORS & VALVES

Remove the rubber tubes and plastic rings from the One-Pump Connectors, unscrew the valve and press them out.

03 ATTACH A STRING TO THE CONNECTOR

Attach a string (or use one of the guy lines) to the One-Pump Connector farthest from the repair opening.

04 PULL OUT THE BLADDER

Pull the bladder out of the outer sleeve carefully – the string will be automatically guided into the outer sleeve. Use the string to reinsert the bladder after repair.

05 REPAIR/ EXCHANGE

Now you can repair the hole with the self-adhesive patches provided in the repair kit. Cut a patch with rounded corners out of the repair material that is approximately 2 cm larger on all sides than the damaged area. If necessary, replace the damaged bladder with a new one.

06 INSERT THE BLADDER

Take great care not to twist the bladder when reinserting. Twisting the bladder can lead to damage when pumping it up. After the bladder has been reinserted, fold the end of the bladder and the closing piece into the end of the strut.

07 CLOSE THE VELCRO

Be sure to securely fasten the Velcro inside the strut opening.

08 INFLATE THE BLADDER SLOWLY

After the bladder has been inserted, make sure it fills out the space inside the strut completely. Then slowly fill the bladder with air, taking care that it is positioned correctly. If the bladder is not positioned correctly (e.g. bladder is twisted or bladder does not fill out the space inside the strut completely), correct its position or remove it and reinsert it correctly.

★

PLEASE NOTE

If the outer sleeve of a strut is damaged, it should be replaced immediately. Otherwise, you might damage the inner bladder. In this case, unfasten the Velcro closure on the corners and at the bottom so you can remove and replace the entire strut.

CARE

The Heimplanet tents are made from extremely durable materials. With just a bit of care, it will serve you as a reliable home for many years to come.

BE GOOD TO YOUR
TENT AND YOUR
TENT WILL BE GOOD
TO YOU.

Give your tent a quick wipe down after each use to prevent mold and mildew stains from forming.

Stains and grime are best removed with a soft cloth and lukewarm, soapy water. Do not use a washing machine to clean your tent or have it professionally dry-cleaned.

If a zipper is difficult to open and close, simply treat it with a bit of wax.

THANK YOU
FOR YOUR SUPPORT.
WE HOPE YOU ENJOY OUR
PRODUCT AS WE ENJOYED
ENGINEERING IT.

—

JOIN THE MOMENT AND
MAKE YOURSELF A HOME
WHEREVER YOU GO.



HEIMPLANET ENTWICKLUNGS GMBH
SHANGHAIALLEE 21
20457 HAMBURG / GERMANY

-

WWW.HEIMPLANET.COM

-

WWW.FACEBOOK.COM/HEIMPLANET

WWW.X.COM/HEIMPLANET

WWW.INSTAGRAM.COM/HEIMPLANET

