

# **RAZR** MODULAR

## AMERICAS & APAC Rack Fixtures with 8-inch Light Bar Spacing

Designed for high-performance vertical farms, Fluence's award winning RAZR Modular System illuminates your crops from propagation to harvest, yielding remarkable savings on energy and maintenance.

### **FLEXIBLE PERFORMANCE**

Fluence's years of experience with vertical farm growers has proven PhysioSpec™ BROAD R3a is the best spectrum for propagation and full-cycle cultivation of a multitude of leafy greens, microgreens, herbs and other vegetables. In addition to the R3a broad white spectrum, RAZR Modular Fixtures are now available in a total of seven spectra, three different system lengths and an IP67 rated enclosed version for harsh environments.

### **FLEXIBLE MOUNTING**

With a large selection of mounting accessories and plug & play cables, the RAZR Modular System features low profile, highly configurable fixtures for simple, seamless integration into a variety of vertical racks. Each individual light bar and all mounting accessories are field replaceable, reducing grower's maintenance and cost of ownership over years of farm operations.



### **APPLICATIONS**

- Full-Cycle Cultivation of Leafy Greens, Microgreens, and Culinary Herbs
- Crop Propagation
- Wire Shelving Units (i.e. Baker's Racks)
- Pallet Racks
- Vertical Grow Racks
- Growth Chambers

# RAZR Modular

## Rack Fixtures with 8-inch Light Bar Spacing



SYSTEM SPECIFICATION	
Mounting Height Above Canopy	>8" [20 cm]
Number of Light Bars per System	6, 9, 12, 15, 18, 21, and 24
AC Input Power	160-620 W @ 277 V AC
AC Input Voltage	120-277 V, 347-480 V AC, 50/60 Hz
Power Factor*	> 0.98 (15-24 bars) and >0.92 (6-12 bars)
Total Harmonic Distortion (THD)*	< 10% (15-24 bars) and <20% (6-12 bars)
Dimming	Source Signal Driver, 0/1-10 V, OFF/ 10-100%
Max. Ambient Temperature	104°F / 40°C (95°F / 35°C @ 120 V AC)
Driver Lifetime at 40°C Ambient	> 50,000 hrs
Warranty	5 Year Limited
IP Rating per IEC 60598-1	IP66
Certifications	cETLus UL 8800, CE, Wet Location, DLC

LIGHT BAR SPECIFICATION	
Light Output PPF (per bar)**	62-93 μmol/s
Efficacy (Spectrum)**	2.5-3.8 μmol/J
Nominal DC Wattage/Bar	22-24 W
Light Distribution (Beam Angle)	120° Lambertian
Thermal Management	Passive
Lifetime LED Q90 (L90B50)	> 50,000 hrs
Thermal Management	Passive
IP Rating per IEC 60598-1	IP66 (S/R) / IP67 (SL/RL)

\* @ 100% output. Contact factory for values over dimming range  
 \*\* See page 3 for specific performance values by spectrum



HORIZONTAL ARRAY LAYOUT



VERTICAL ARRAY LAYOUT

### SYSTEM ORDERING GUIDE

System includes light bars, power supply, and DC cables (Splitters and Manifolds). See next page for other accessories (frame and mounting)

FAMILY <sup>1</sup>	Light Bar Length <sup>1</sup>	LED Layout <sup>1</sup>	Spectra <sup>1</sup>	DC Output and # of Bars per Power Supply <sup>6</sup>	Input Voltage	DC Splitter Cable <sup>9</sup>	DC Manifold Cable <sup>9</sup>	Packaging	
RM RAZR Modular	44" 44"	S	Standard Uniform	BW3 BROAD R3a	584-24 584 W DC, 24 Bars	LVG 120-277 V AC HVG <sup>7</sup> 347-480 V AC HVE <sup>8</sup> 347-400 V AC	00 None	B Bulk S Single	
		SL	Standard Uniform Enclosed		511-21 511 W DC, 21 Bars				
					438-18 438 W DC, 18 Bars				
	48 48"	S	Standard Uniform	BW3 BROAD R3a	365-15 365 W DC, 15 Bars	3A 3-Bar, Right Angle, Horizontal 3S 3-Bar, Straight, Vertical	4P <sup>10</sup> 4-Port, 4-ft Trunk 6P <sup>11</sup> 6-Port, 4-ft Trunk 8P <sup>12</sup> 8-Port, 2-ft Trunk		
									292-12 292 W DC, 12 Bars
									219-9 219 W DC, 9 Bars
		SL	Standard Uniform Enclosed	BW4 <sup>4</sup> BROAD R4 BP6 <sup>4</sup> BROAD R6 BP8 <sup>4</sup> BROAD R8 DR9 <sup>4</sup> DUAL R9B MRD <sup>4,5</sup> MONO RED (660 nm) MFR <sup>4,5</sup> FAR RED (730 nm)	146-6 146 W DC, 6 Bars				
53 53"	S	Standard Uniform	BW3 BROAD R3a						
				SL	Standard Uniform Enclosed				
				R <sup>3</sup>	Redistributed				
		RL <sup>3</sup>	Redistributed Enclosed						

- Product listed on DLC QPL as DC powered module RM-48-xx-xxx (example: RM-48-SL-BW4)
- 44" light bar length is not a listed DLC configuration.
- Redistributed LED layout available only with 53" light bar length.
- Spectra BW4, BP6, BP8, DR9, MRD, and MFR are only available with 48" light bar length.
- MRD and MFR are not listed DLC configurations. Extended lead times may apply. Contact sales for details.
- Contact Fluence sales for the wiring diagram of selected Electrical System
- HVG available with 584-24, 511-21, 438-18, and 365-15 power supply configurations only.
- HVE available with 292-12, 219-9 and 146-6 power supply configurations only.
- All configurations sold by Fluence maintain cabling losses of 2% or less. See page 6 for more details.
- 4P DC Manifold cable is available with all power supply configurations except 584-24, 511-21, 438-18, and 365-15 with 3S DC Splitter Cable.
- 6P DC Manifold cable is available with 438-18 and 365-15 power supply configurations with 3S DC Splitter Cable only.
- 8P DC Manifold cable is available with 584-24 and 511-21 power supply configurations with 3S DC Splitter Cable only.



Contact **FLUENCE** @  
 support@fluence.science ✉  
 www.fluence.science/RAZR 🌐

# RAZR Modular

## Rack Fixtures with 8-inch Light Bar Spacing



### SPECTRA

PhysioSpec™ **BROAD R3a**

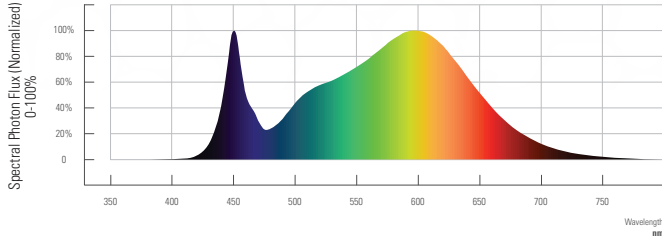

PhysioSpec™ **BROAD R4**

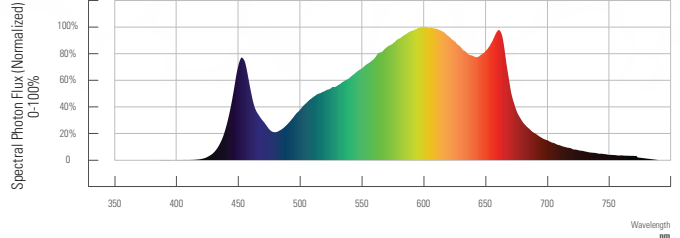

PhysioSpec™ **BROAD R6**

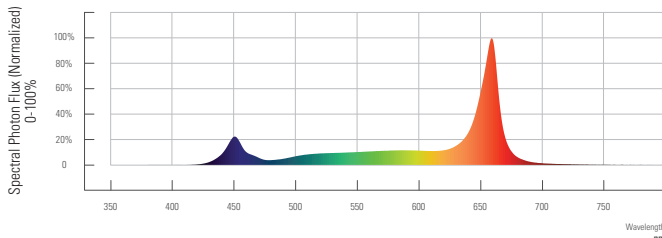

PhysioSpec™ **BROAD R8**

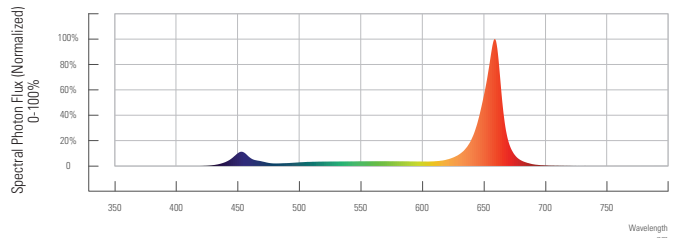

PhysioSpec™ **DUAL R9B**

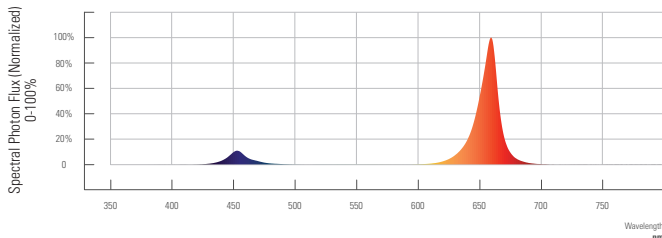

PhysioSpec™ **MONO RED (660nm)**

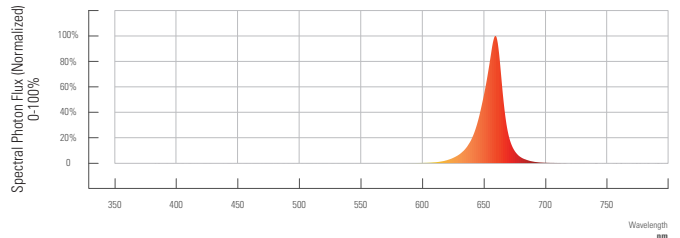

PhysioSpec™ **MONO FAR RED (730 nm)**

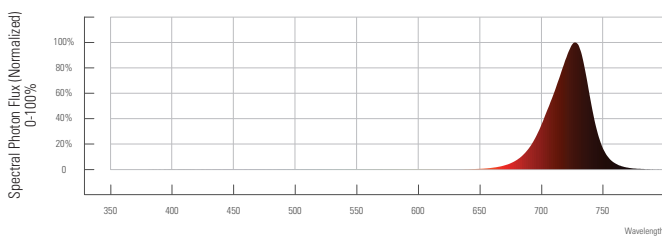

PhysioSpec™ Spectrum	Enclosure Type	Light Bar Output (μmol/s)	Efficacy (μmol/J)	SKU Abbreviation
<b>BROAD R3a</b>	No Enclosure	68	2.6	RM-48-S-BW3
	Enclosed	64	2.5	RM-48-SL-BW3
<b>BROAD R4</b>	No Enclosure	66	2.8	RM-48-S-BW4
	Enclosed	62	2.7	RM-48-SL-BW4
<b>BROAD R6</b>	No Enclosure	77	3.3	RM-48-S-BP6
	Enclosed	73	3.1	RM-48-SL-BP6
<b>BROAD R8</b>	No Enclosure	89	3.6	RM-48-S-BP8
	Enclosed	85	3.5	RM-48-SL-BP8
<b>DUAL R9B</b>	No Enclosure	92	3.9	RM-48-S-DR9
	Enclosed	87	3.7	RM-48-SL-DR9
<b>MONO RED (600 nm)</b>	No Enclosure	93	3.7	RM-48-S-MRD
	Enclosed	87	3.5	RM-48-SL-MRD
<b>FAR RED (730 nm)</b>	No Enclosure	74*	3.1*	RM-48-S-MFR
	Enclosed	70*	2.9*	RM-48-SL-MFR

\*Based on total photon flux (wavelengths 400-800 nm)

**Disclaimer:** Performance values are from representative tests performed in accordance industry standards listed. Actual application performance may vary due to component tolerances and installation, environmental, and field measurements conditions.



Contact **FLUENCE** @  
[support@fluence.science](mailto:support@fluence.science)  
[www.fluence.science/RAZR](http://www.fluence.science/RAZR)

# RAZR Modular

## Rack Fixtures with 8-inch Light Bar Spacing



### 2'X4' 3-BAR RACK FIXTURE DIMENSIONS

**WITH RIGHT ANGLE DC SPLITTER CABLE**  
(HORIZONTAL ARRAY LAYOUT)

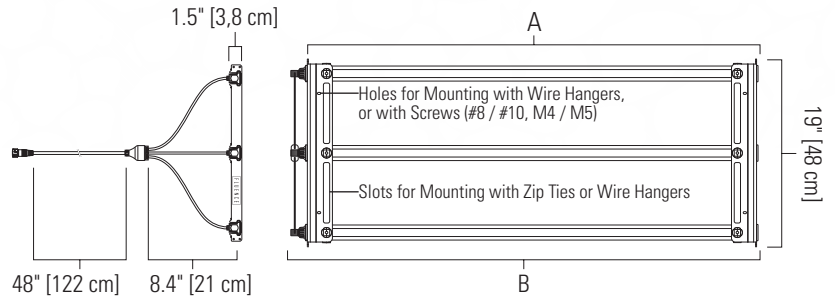
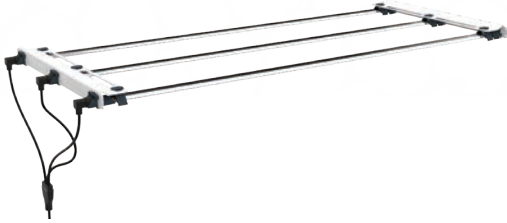

**WITH STRAIGHT DC SPLITTER CABLE**  
(VERTICAL ARRAY LAYOUT)

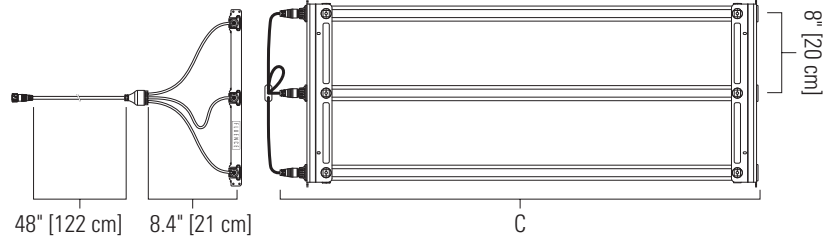
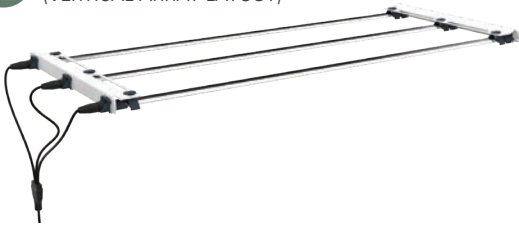

### 4'X4' 6-BAR RACK FIXTURE DIMENSIONS

**WITH RIGHT ANGLE DC SPLITTER CABLE**  
(HORIZONTAL ARRAY LAYOUT)

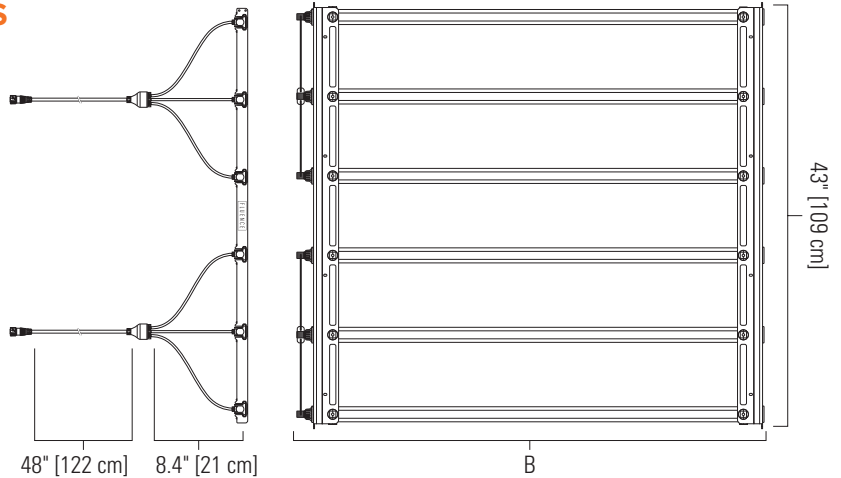

**WITH STRAIGHT DC SPLITTER CABLE**  
(VERTICAL ARRAY LAYOUT)

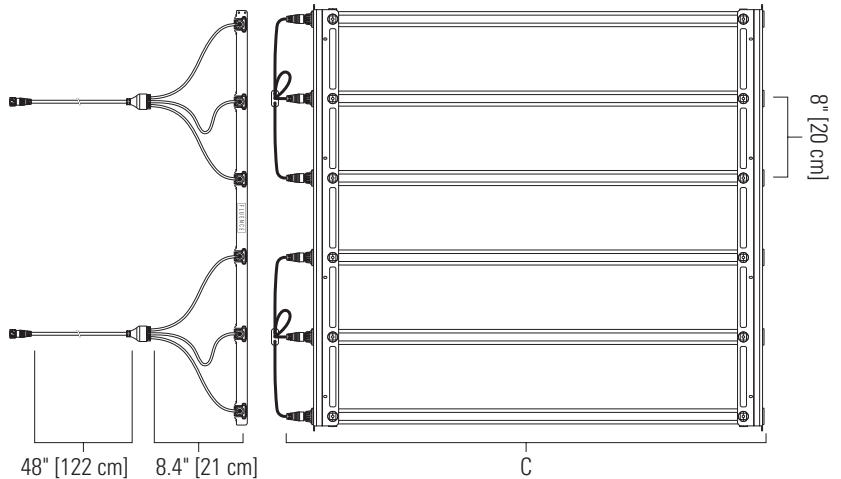

Configuration	Dimension A	Dimension B	Dimension C
RM-44-S	42.2" [107 cm]	43.9" [111 cm]	44.7" [113 cm]
RM-44-SL	42.4" [108 cm]	43.8" [111 cm]	44.6" [113 cm]
RM-48-S	45.2" [115 cm]	47.0" [119 cm]	47.7" [121 cm]
RM-48-SL	45.4" [116 cm]	46.9" [119 cm]	47.6" [121 cm]
RM-53-S/R	51.4" [130 cm]	53.2" [135 cm]	53.9" [137 cm]
RM-53-SL/RL	51.6" [131 cm]	53.1" [135 cm]	53.8" [137 cm]



Contact **FLUENCE** @  
support@fluence.science ✉  
www.fluence.science/RAZR 🌐

# RAZR Modular

## Rack Fixtures with 8-inch Light Bar Spacing



### LIGHT BAR DIMENSIONS AND WEIGHT

Light Bar	SKU on Part Label	Length	Width	Height	Mounting	Weight
44" no enclosure	RM-44-S-xxx	43" [110 cm]	1.8" [4,6 cm]	1.2" [3,0 cm]	42.5" [108 cm]	0.48 lb [0,22 kg]
44" enclosed	RM-44-SL-xxx	42.8" [109 cm]	1.9" [4,7 cm]	1.5" [3,8 cm]	42.7" [109 cm]	0.87 lb [0,39 kg]
48" no enclosure	RM-48-S-xxx	46.2" [117 cm]	1.8" [4,6 cm]	1.2" [3,0 cm]	45.6" [116 cm]	0.51 lb [0,23 kg]
48" enclosed	RM-48-SL-xxx	46" [116 cm]	1.9" [4,7 cm]	1.5" [3,8 cm]	45.8" [116 cm]	0.93 lb [0,42 kg]
53" no enclosure	RM-53-S-xxx / RM-53-R-xxx	52.3" [133 cm]	1.8" [4,6 cm]	1.2" [3,0 cm]	51.8" [131 cm]	0.57 lb [0,26 kg]
53" enclosed	RM-53-SL-xxx / RM-53-RL-xxx	52.1" [132 cm]	1.9" [4,7 cm]	1.5" [3,8 cm]	52.0" [132 cm]	1.04 lb [0,47 kg]

#### LIGHT BAR (NO ENCLOSURE S/R)

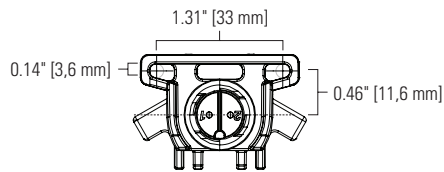
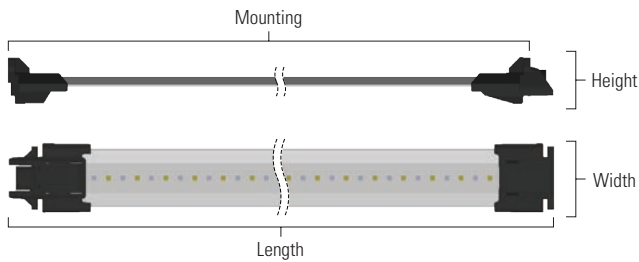

#### LIGHT BAR (ENCLOSED SL/RL)

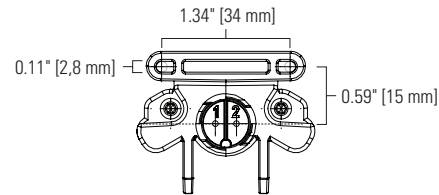
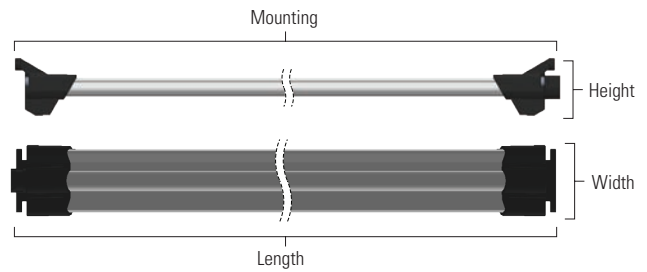

### POWER SUPPLY DIMENSIONS AND WEIGHT

Power Supply	SKU on Part Label	Length	Width	Height	Weight
120-277V AC PSU 365/438/511/584 W DC	RM-48-S-xxx-365/438/511/584-xx-LVG	13.4-14.6" [34-37 cm]	5.3" [13,4 cm]	2.6" [6,6 cm]	7.5-8.1 lb [3,4-3,7 kg]
347-480V AC PSU 365/438/511/584 W DC	RM-48-S-xxx-365/438/511/584-xx-HVG	11.5-13.4" [29-34 cm]	5.3-6.4" [13,4-16,3 cm]	2.4-2.6" [6,3-6,6 cm]	6.3-8.1 lb [2,9-3,7 kg]
120-277 V AC PSU 146/219/292 W DC	RM-48-S-xxx-146/219/292-xx-LVG	12.6-12.9" [32-33 cm]	4.3" [10,9 cm]	2.5-2.7" [6,4-6,8 cm]	5.0-5.8 lb [2,3-2,6 kg]
347-400 V AC PSU 146/219/292 W DC	RM-48-S-xxx-146/219/292-xx-HVE	12.6" [32 cm]	4.3" [10,9 cm]	2.5" [6,4 cm]	5.0 lb [2,3 kg]

#### POWER SUPPLY

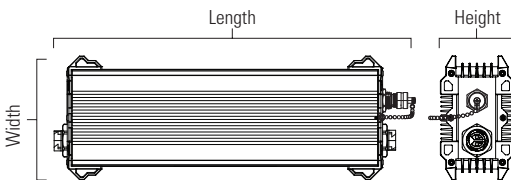

Contact **FLUENCE** @  
[support@fluence.science](mailto:support@fluence.science)  
[www.fluence.science/RAZR](http://www.fluence.science/RAZR)

# RAZR Modular



## Rack Fixtures with 8-inch Light Bar Spacing



### DC SPLITTER AND MANIFOLD CONFIGURATIONS

System	DC Splitter	DC Manifold	Part Description	Part Number	Quantity	Figure
584-24	3A	4P	3-Bar Right Angle DC Splitter, 4-FT (122 cm) Trunk	71635	8	<b>C1</b>
			4-Port DC Manifold Cable, 4-FT (122 cm) Trunk	71661	2	<b>C2</b>
			Manifold Splitter Cable, 3-FT (91 cm), to power supply	71670	1	<b>C3</b>
	3S	8P	3-Bar Straight DC Splitter, 4-FT (122 cm) Trunk	71807	8	<b>C5</b>
			8-Port DC Manifold Cable, 2.25-FT (69 cm) Trunk	71587	1	<b>C6</b>
			Manifold Port Dust Cap (covering unused ports)	71285	1	<b>C4</b>
511-21	3A	4P	3-Bar Right Angle DC Splitter, 4-FT (122 cm) Trunk	71635	7	<b>C1</b>
			4-Port DC Manifold Cable, 4-FT (122 cm) Trunk	71661	2	<b>C2</b>
			Manifold Splitter Cable, 3-FT (91 cm), to power supply	71670	1	<b>C3</b>
			Manifold Port Dust Cap (covering unused ports)	71285	1	<b>C4</b>
	3S	8P	3-Bar Straight DC Splitter, 4-FT (122 cm) Trunk	71807	7	<b>C5</b>
			8-Port DC Manifold Cable, 2.25-FT (69 cm) Trunk	71587	1	<b>C6</b>
			Manifold Port Dust Cap (covering unused ports)	71285	1	<b>C4</b>
			3-Bar Right Angle DC Splitter, 4-FT (122 cm) Trunk	71635	6	<b>C1</b>
			4-Port DC Manifold Cable, 4-FT (122 cm) Trunk	71661	2	<b>C2</b>
438-18	3A	4P	Manifold Splitter Cable, 3-FT (91 cm), to power supply	71670	1	<b>C3</b>
			Manifold Port Dust Cap (covering unused ports)	71285	2	<b>C4</b>
			3-Bar Straight DC Splitter, 4-FT (122 cm) Trunk	71807	6	<b>C5</b>
	3S	6P	6-Port DC Manifold Cable, 4-FT (122 cm) Trunk	71431	1	<b>C7</b>
			3-Bar Right Angle DC Splitter, 4-FT (122 cm) Trunk	71635	5	<b>C1</b>
			4-Port DC Manifold Cable, 4-FT (122 cm) Trunk	71661	2	<b>C2</b>
365-15	3A	4P	Manifold Splitter Cable, 3-FT (91 cm), to power supply	71670	1	<b>C3</b>
			Manifold Port Dust Cap (covering unused ports)	71285	3	<b>C4</b>
			3-Bar Straight DC Splitter, 4-FT (122 cm) Trunk	71807	5	<b>C5</b>
			6-Port DC Manifold Cable, 4-FT (122 cm) Trunk	71587	1	<b>C6</b>
	3S	6P	Manifold Port Dust Cap (covering unused ports)	71285	1	<b>C4</b>
			3-Bar Right Angle DC Splitter, 4-FT (122 cm) Trunk	71635	4	<b>C1</b>
			4-Port DC Manifold Cable, 4-FT (122 cm) Trunk	71661	1	<b>C2</b>
292-12	3A	4P	3-Bar Straight DC Splitter, 4-FT (122 cm) Trunk	71807	4	<b>C5</b>
			4-Port DC Manifold Cable, 4-FT (122 cm) Trunk	71661	1	<b>C2</b>
	3S	4P	3-Bar Right Angle DC Splitter, 4-FT (122 cm) Trunk	71635	3	<b>C1</b>
			4-Port DC Manifold Cable, 4-FT (122 cm) Trunk	71661	1	<b>C2</b>
219-9	3A	4P	Manifold Port Dust Cap (covering unused ports)	71285	1	<b>C4</b>
			3-Bar Straight DC Splitter, 4-FT (122 cm) Trunk	71807	3	<b>C5</b>
			4-Port DC Manifold Cable, 4-FT (122 cm) Trunk	71661	1	<b>C2</b>
	3S	4P	Manifold Port Dust Cap (covering unused ports)	71285	1	<b>C4</b>
			3-Bar Right Angle DC Splitter, 4-FT (122 cm) Trunk	71635	2	<b>C1</b>
			4-Port DC Manifold Cable, 4-FT (122 cm) Trunk	71661	1	<b>C2</b>
146-6	3A	4P	Manifold Port Dust Cap (covering unused ports)	71285	2	<b>C4</b>
			3-Bar Straight DC Splitter, 4-FT (122 cm) Trunk	71807	2	<b>C5</b>
			4-Port DC Manifold Cable, 4-FT (122 cm) Trunk	71661	1	<b>C2</b>
	3S	4P	Manifold Port Dust Cap (covering unused ports)	71285	2	<b>C4</b>
			3-Bar Right Angle DC Splitter, 4-FT (122 cm) Trunk	71635	2	<b>C1</b>
			4-Port DC Manifold Cable, 4-FT (122 cm) Trunk	71661	1	<b>C2</b>



Contact **FLUENCE**   
 support@fluence.science   
 www.fluence.science/RAZR 

# RAZR Modular

## Rack Fixtures with 8-inch Light Bar Spacing

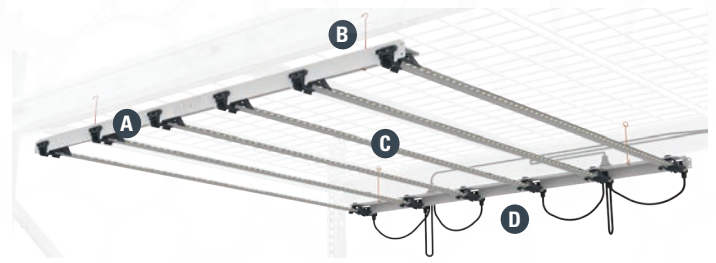
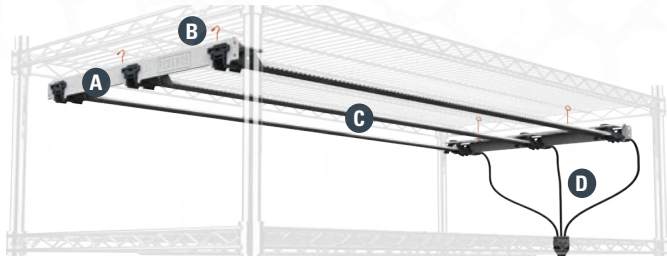

**A** Fixture Frames    **B** Fixture Wire Hangers    **C** Light Bar (Electrical System)    **D** DC Splitter Cables (Electrical System)

### RACK FIXTURE FRAME ACCESSORIES

System	Number of Fixtures	Fixture Frames	Quantity per System	Ordering Code	QTY/ Carton
<b>584-24</b>	8 (2' x 4' 3-Bar)	<b>A1</b> 2 ft, 3-Bar Fixture Frame, 8 in Bar Spacing	8 Kits (16 pcs)	RM-2L8S-01	1 Kit (2 pcs)
	4 (4' x 4' 6-Bar)	<b>A2</b> 4 ft, 6-Bar Fixture Frame, 8 in Bar Spacing	4 Kits (8 pcs)	RM-4L8S-01	1 Kit (2 pcs)
<b>511-21</b>	7 (2' x 4' 3-Bar)	<b>A1</b> 2 ft, 3-Bar Fixture Frame, 8 in Bar Spacing	7 Kits (14 pcs)	RM-2L8S-01	1 Kit (2 pcs)
<b>438-18</b>	6 (2' x 4' 3-Bar)	<b>A1</b> 2 ft, 3-Bar Fixture Frame, 8 in Bar Spacing	6 Kits (12 pcs)	RM-2L8S-01	1 Kit (2 pcs)
	3 (4' x 4' 6-Bar)	<b>A2</b> 4 ft, 6-Bar Fixture Frame, 8 in Bar Spacing	3 Kits (6 pcs)	RM-4L8S-01	1 Kit (2 pcs)
<b>365-15</b>	5 (2' x 4' 3-Bar)	<b>A1</b> 2 ft, 3-Bar Fixture Frame, 8 in Bar Spacing	5 Kits (10 pcs)	RM-2L8S-01	1 Kit (2 pcs)
<b>292-12</b>	4 (2' x 4' 3-Bar)	<b>A1</b> 2 ft, 3-Bar Fixture Frame, 8 in Bar Spacing	4 Kits (8 pcs)	RM-2L8S-01	1 Kit (2 pcs)
	2 (4' x 4' 6-Bar)	<b>A2</b> 4 ft, 6-Bar Fixture Frame, 8 in Bar Spacing	2 Kit (4 pcs)	RM-4L8S-01	1 Kit (2 pcs)
<b>219-9</b>	3 (2' x 4' 3-Bar)	<b>A1</b> 2 ft, 3-Bar Fixture Frame, 8 in Bar Spacing	3 Kits (6 pcs)	RM-2L8S-01	1 Kit (2 pcs)
<b>146-6</b>	2 (2' x 4' 3-Bar)	<b>A1</b> 2 ft, 3-Bar Fixture Frame, 8 in Bar Spacing	2 Kits (4 pcs)	RM-2L8S-01	1 Kit (2 pcs)
	1 (4' x 4' 6-Bar)	<b>A2</b> 4 ft, 6-Bar Fixture Frame, 8 in Bar Spacing	1 Kit (2 pcs)	RM-4L8S-01	1 Kit (2 pcs)

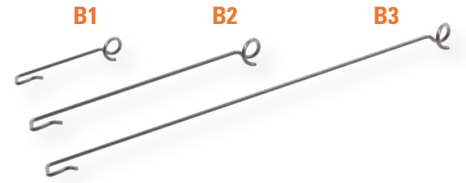

### FIXTURE TO RACK MOUNTING ACCESSORIES

Mounting Accessories	Length	QTY per Fixtures	Ordering Code	QTY / Carton
<b>B1</b> Fixture Wire Hanger, Short - Baker's Rack	2" [5 cm]	1 Kit (4 pcs)	RM-SHANGER-01	1 Kit (4 pcs)
<b>B2</b> Fixture Wire Hanger, Medium - PIPP Rack	4" [10 cm]	1 Kit (4 pcs)	RM-MHANGER-01	1 Kit (4 pcs)
<b>B3</b> Fixture Wire Hanger, Long - Pallet Rack	7.5" [19 cm]	1 Kit (4 pcs)	RM-LHANGER-01	1 Kit (4 pcs)

### RAZR MODULAR RACK FIXTURE SPECIFICATION

Fixture Type	Light Bar Spacing	Number of Light Bars	Fixture PPF (400-700nm)	Fixture DC Power	Fixture Mounting Height	Fixture Dimensions*	Fixture Weight
<b>2'x4' 3-Bar</b>	8" [20 cm]	3 Light Bars	186-278 µmol/s	66-76 W DC	≥ 8" [20 cm]	46" x 19" x 1.6" [1172 x 480 x 40 mm]	2.9 lb [1.3 kg]
<b>4'x4' 6-Bar</b>	8" [20 cm]	6 Light Bars	371-557 µmol/s	131-151 W DC	≥ 8" [20 cm]	46" x 43" x 1.6" [1172 x 1090 x 40 mm]	6.1 lb [2.8 kg]

\* without DC Cabling

### NOMINAL ELECTRICAL AC INPUT FOR FIXTURE ARRAYS

Fixture Array   # of Fixtures per Power Supply		AC VOLTAGE	120 V	208 V	230 V	277 V	347 V	400 V	480 V
2'x4' 3-Bar	4'x4' 6-Bar								
8 Fixtures	4 Fixtures	AC Current	5.33 A	3.04 A	2.74 A	2.31 A	1.79 A	1.56 A	1.33 A
		AC Power	638 W	623 W	621 W	619 W	618 W	617 W	616 W
7 Fixtures	N/A	AC Current	4.66 A	2.66 A	2.40 A	2.03 A	1.57 A	1.37 W	1.17 A
		AC Power	556 W	544 W	543 W	541 W	540 W	540 W	539 W
6 Fixtures	3 Fixtures	AC Current	3.98 A	2.28 A	2.06 A	1.76 A	1.35 A	1.18 A	1.02 A
		AC Power	475 W	466 W	465 W	463 W	463 W	463 W	463 W
5 Fixtures	N/A	AC Current	3.31 A	1.91 A	1.74 A	1.50 A	1.14 A	0.99 A	0.87 A
		AC Power	395 W	388 W	388 W	386 W	387 W	387 W	387 W
4 Fixtures	2 Fixtures	AC Current	2.72 A	1.57 A	1.44 A	1.23 A	0.95 A	0.84 A	
		AC Power	321 W	316 W	316 W	315 W	319 W	318 W	
3 Fixtures	N/A	AC Current	2.05 A	1.21 A	1.10 A	0.97 A	0.74 A	0.66 A	
		AC Power	242 W	239 W	238 W	238 W	242 W	242 W	
2 Fixtures	1 Fixture	AC Current	1.39 A	0.85 A	0.78 A	0.72 A	0.54 A	0.48 A	
		AC Power	163 W	162 W	162 W	162 W	165 W	166 W	



Contact **FLUENCE** @  
 support@fluence.science  
 www.fluence.science/RAZR

# RAZR Modular

## Rack Fixtures with 8-inch Light Bar Spacing



### ACCESSORIES FOR POWER SUPPLY

Power Supply Mounting Hardware	PSU LVG 292 W DC 120-277 V AC	PSU HVE 292 W DC 347-400 V AC	PSU LVG 584 W DC 120-277 V AC	PSU HVG 584 W DC 347-480 V AC	Ordering Code	QTY / Carton
PSU 292 W Power Supply Surface Mount Kit	1 Kit	1 Kit	N/A	N/A	AMPS-10491-10	10 Kits
PSU LVG 584 W Power Supply Surface Mount Kit	N/A	N/A	1 Kit	N/A	AMPS-10453-10	10 Kits
PSU HVG 584 W Power Supply Surface Mount Kit	N/A	N/A	N/A	1 Kit	AMPS-10454-10	10 Kits
Unistrut Wire Hanger (for Strut Width ≤ 1-5/8" / 45 mm)	1 Kit	1 Kit	1 Kit	1 Kit	AMV2-10120-20	20 Kits
Pipe Wire Hanger (for Pipe Diameter ≤ 1-3/4" / 45 mm)	1 Kit	1 Kit	1 Kit	1 Kit	AMV2-10121-20	20 Kits
Square Wire Hanger (for Truss Width ≤ 2-3/4" / 70 mm)	1 Kit	1 Kit	1 Kit	1 Kit	AMV2-10119-20	20 Kits

AC Power Cable - <b>AMERICAS</b> (Power Supply to AC Line)	Quantity per Power Supply	Ordering Code	QTY/ Carton
6-FT (1.83 m) AC Cable, NEMA 5-15P Plug, M19 Push Lock, Max 125 V AC	1 Pc	CACA-70748-10	10 Pcs
6-FT (1.83 m) AC Cable, NEMA 6-15P Plug, M19 Push Lock, Max 250 V AC	1 Pc	CACA-70750-10	10 Pcs
6-FT (1.83 m) AC Cable, NEMA L7-15P Plug, M19 Push Lock, Max 277 V AC	1 Pc	CACA-70752-10	10 Pcs
6-FT (1.83 m) AC Cable, Pigtail, M19 Push Lock, Max 480 V AC	1 Pc	CACA-70754-10	10 Pcs
15-FT (4.57 m) AC Cable, NEMA 5-15P Plug, M19 Push Lock, Max 125 V AC	1 Pc	CACA-70749-05	5 Pcs
15-FT (4.57 m) AC Cable, NEMA 6-15P Plug, M19 Push Lock, Max 250 V AC	1 Pc	CACA-70751-05	5 Pcs
15-FT (4.57 m) AC Cable, NEMA L7-15P Plug, M19 Push Lock, Max 277 V AC	1 Pc	CACA-70753-05	5 Pcs
15-FT (4.57 m) AC Cable, Pigtail, M19 Push Lock, Max 480 V AC	1 Pc	CACA-70755-05	5 Pcs
Wieland AC Connector Adapter for Power Supply, STW PVC, M19 Push Lock, 18-IN (0.46 m), Wieland Part #: 96.032.0053.1 (Male)	1 Pc	CACA-71467-10	10 Pcs

DC Dimming Signal Cable - <b>AMERICAS</b> (Power Supply to Dimming Control)	Quantity per Power Supply	Ordering Code	QTY/ Carton
11-IN (0.28 m) Dimming Signal Cable, Pigtail, M12 Connector	1 Pc	CDMA-71561-10	10 Pcs
5-FT (1.52 m) Dimming Signal Cable, Pigtail, M12 Connector	1 Pc	CDMA-71560-10	10 Pcs

AC Power Cable - <b>INTERNATIONAL</b> (Power Supply to AC Line)	Quantity per Power Supply	Ordering Code	QTY/ Carton
1,83 m (6 FT) AC Cable, VDE, Schuko Type F7 Plug, M19 Push Lock, 230 V AC	1 Pc	CACE-70774-10	10 Pcs
1,83 m (6 FT) AC Cable, VDE, Pigtail, M19 Push Lock (Not for CE Countries)	1 Pc	CACE-71161-10	10 Pcs
4,57 m (15 FT) AC Cable, VDE, Schuko Type F7 Plug, M19 Push Lock, 230 V AC	1 Pc	CACE-70775-05	5 Pcs
4,57 m (15 FT) AC Cable, VDE, Pigtail, M19 Push Lock (Not for CE Countries)	1 Pc	CACE-71162-05	5 Pcs
70 cm (27.6 IN) AC Cable, Dca, Pigtail, M19 Push Lock (400V CE Application)	1 Pc	CACE-71411-10	10 Pcs
80 cm (31.5 IN) AC Cable, Dca, Pigtail (Use with Adapter Cable) Wieland Connector Part #: 20i30F B2 ZR1S H GN02 (Female)	1 Pc	CACE-71650-10	10 Pcs
Wieland AC Connector Adapter for Power Supply, Dca Cable, M19 Push Lock, 20 cm (8 IN), Wieland Part #: RST20i3F S2 ZR1SVH GN0 (Male)	1 Pc	CACE-71576-10	10 Pcs
1,83 m (6 FT) AC Cable, VDE, SAA 3-Prong Plug, M19 Push Lock, Max 250 V AC (Australia and New Zealand)	1 Pc	CACP-71519-10	10 Pcs

DC Dimming Signal Cable - <b>INTERNATIONAL</b> (Power Supply to Dimming Control)	Quantity per Power Supply	Ordering Code	QTY/ Carton
80 cm (31.5 IN) Dimming Signal Cable, Cca, Pigtail, M12 Connector	1 Pc	CDME-71526-10	10 Pcs



Contact **FLUENCE**   
 support@fluence.science   
 www.fluence.science/RAZR