



Operator's Manual



BY

WATER TECH™
"The pool invention people™"

Contents

OPERATOR MANUAL

EN

Dear Valued Water Tech Customer,

Thank you for choosing Water Tech's innovative new swimming pool cleaner, the CX-1. The CX-1 has been designed to be completely "user friendly" beginning with its "Hands-Free" launch into your pool. Simply place the cleaner at poolside, press one button and the CX-1 will climb into the pool by itself and get to work.

1. WARNINGS & CAUTIONS.....	2
2. PACKAGE CONTENTS.....	3
3. SPECIFICATIONS.....	4
4. KNOWING YOUR UNIT.....	5
5. KNOWING THE CONTROL PANEL / Smart Features.....	6
a. Select Cleaning Cycle.....	7
b. Weekly Mode Running Schedule / Select Cleaning Mode.....	8
6. PREPARE THE CLEANER FOR USE.....	9
a. Charging.....	9
b. Filter Bag Mounting.....	11
7. START CLEANING.....	13
8. RETRIEVAL AFTER USE.....	14
9. OWNER PERFORMED MAINTENANCE.....	15
a. Cleaning the Filter Bag.....	15
b. Check the Filter Screen.....	15
c. Cleaning Bottom Cover.....	16
d. Impeller Maintenance.....	17
e. Long Term Storage.....	19
10. CX-1 Calibration Procedure.....	20
11. CX-1 Troubleshooting.....	22
12. CX-1 FAQs.....	23



Register at www.watertechcorp.com/register

Water Tech's Customer Service

P: 800-298-8800 (U.S.A. / Canada)

IMPORTANT SAFETY INSTRUCTIONS

Save these instructions



Before using your CX-1, please read the following warnings and read carefully through this Operator Manual.



This appliance is not intended for use by persons (including children) with reduced physical, sensory and mental capabilities, or lack of experience and knowledge, unless they have been given supervision or instructions concerning use of the appliance by a person responsible for their safety. Children should be supervised to ensure that they do not play with the appliance.



1. This product contains Li-Ion batteries. Do **NOT** abuse this product. If you suspect any damage to the batteries, do **NOT** attempt to charge the robot, contact Water Tech Customer Service.
2. Do **NOT** store the CX-1 near heat or an open flame.
3. The safe temperature range for both use and storage is 41 to 113°F (5 to 45°C). Do not attempt to charge, use, or store the CX-1 in temperatures outside of this range.
4. Using any charger other than the one provided with the unit will cause damage and possible injury. **Always charge the unit inside a dry, sheltered area.**
5. **Place the charger in a shaded dry area during both charging and storage.** Keep away from direct sunlight and liquids.
6. Maintain a minimum distance of 3m (10ft.) from the edge of the pool when recharging the batteries of the cleaner.
7. Before operation, unplug the charging cable from the control box.
8. Unit is **NOT** intended for **COMMERCIAL USE**. Unit is **NOT** intended for **OPENING A POOL**.
9. Do not enter the pool while the pool cleaner is working. When the robot is in sleep mode, it is safe to enter the pool.
10. Ensure the electrical outlet used for charging is protected by a ground fault circuit interrupter (GFCI) or an earth leakage interrupter (ELI). **DO NOT use an extension cord or power strip.**
11. The pool cleaner must be charged for 1.5 - 2.5 hours before long term storage.
12. The sole purpose of this product is for use as a robotic pool cleaner as described in this manual; any modifications or other use will VOID the warranty.
13. Do not allow children to use, touch, or play near or around the unit and the charger.
14. Do not use if the unit or charger is damaged in any way.
15. **MAKE SURE** the robotic pool cleaner is unplugged from its power supply and turned off before opening the unit or performing any other maintenance.
16. It is recommended that you clean your filter and check the impeller to make sure it is free and clear of debris after every use.
17. Disconnect the charger from the outlet when not in use.
18. If your robotic pool cleaner is not working as it should or has been dropped or damaged in any way, contact Water Tech Customer Service.
19. Save these instructions. Refer to them frequently. Provide these instructions to others who may use the product.



Package Contents

Pool Blaster CX-1

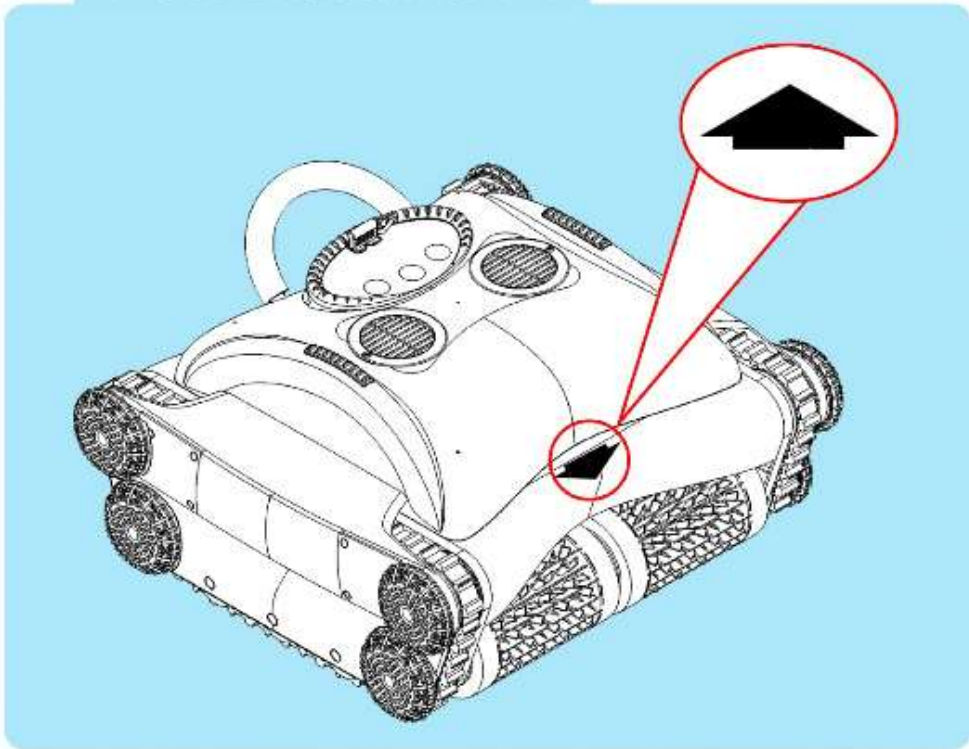

Hook

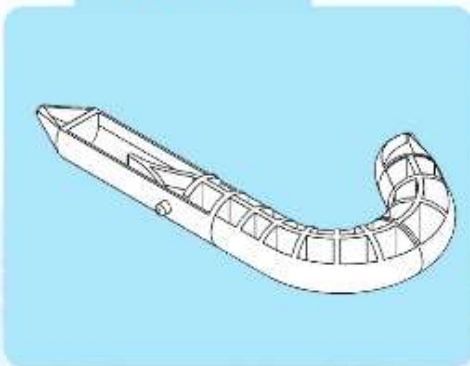

Charger



* The hook attaches to your standard size pool pole to help you retrieve the unit from your pool.



Specifications

CX-1 Specifications

Cleaning Coverage (sq. ft./hr.).....	3542 sq. ft./hr.
Minimal Operation Depth.....	16 in.
Maximum Operation Depth.....	15 ft.
Run Time.....	Up to 4 Hours.
Charging Time.....	6-8 Hours.
Cleaning Width.....	18.0".
Suction Power.....	Up to 7200 gal. /hr.
Unit Size.....	19.85 x 18.0 x 11.0".
Unit Weight.....	21 lbs.
Shipping Weight.....	27 lbs.
Retrieval Hook Adapter.....	Yes.
Warranty.....	2 years.

Charger Specifications

AC-DC CHARGER:	
• Input:	100-240AC Volts 50-60Hz 60W 1.5A
• Output:	29V 2.0A

Battery Specifications

Battery type.....	Li-Ion.
Battery Configuration.....	6S4P.



Knowing Your Unit

Full Unit

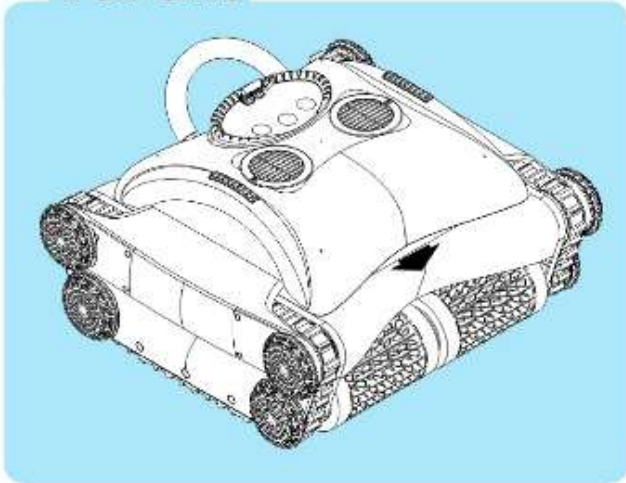

Full Unit - Rear

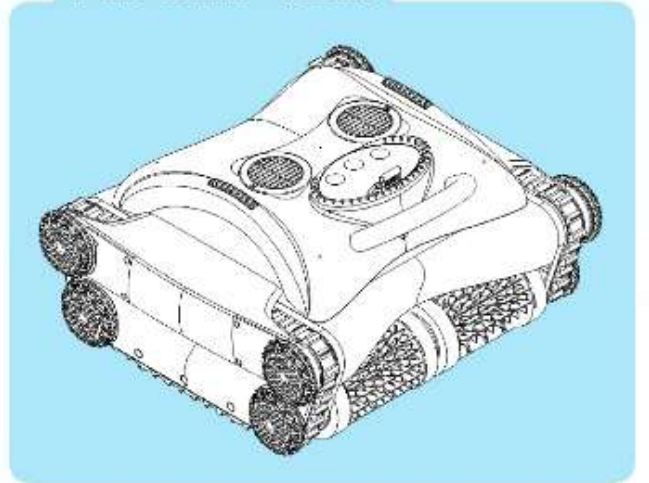

Full Unit - Bottom

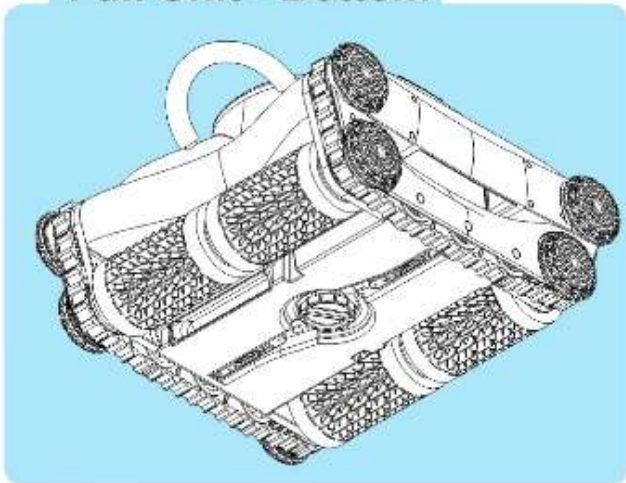

Bottom - Cover Closed

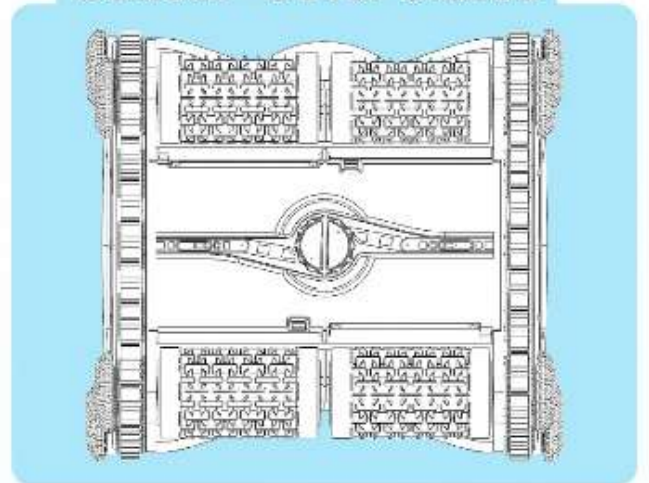

Bottom - Filter Bag - Cover

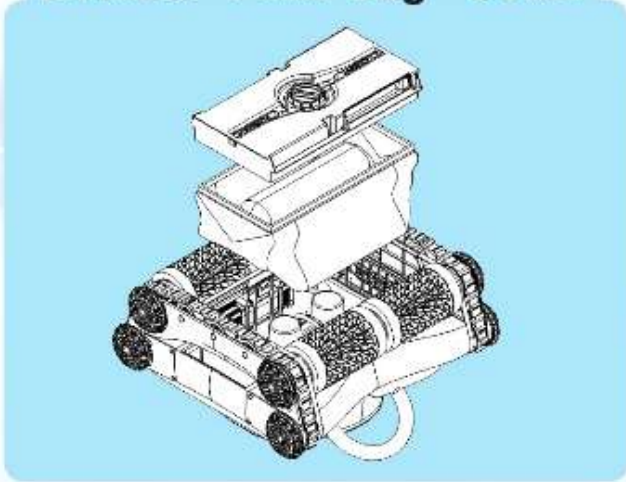

Filter Bag with Cover

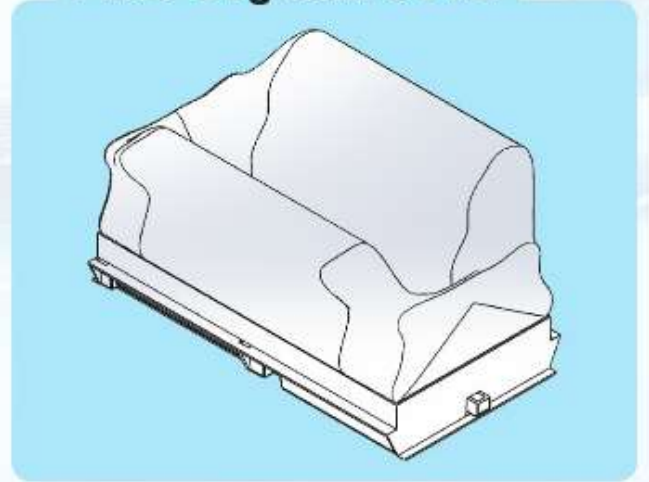



Knowing The Control Panel

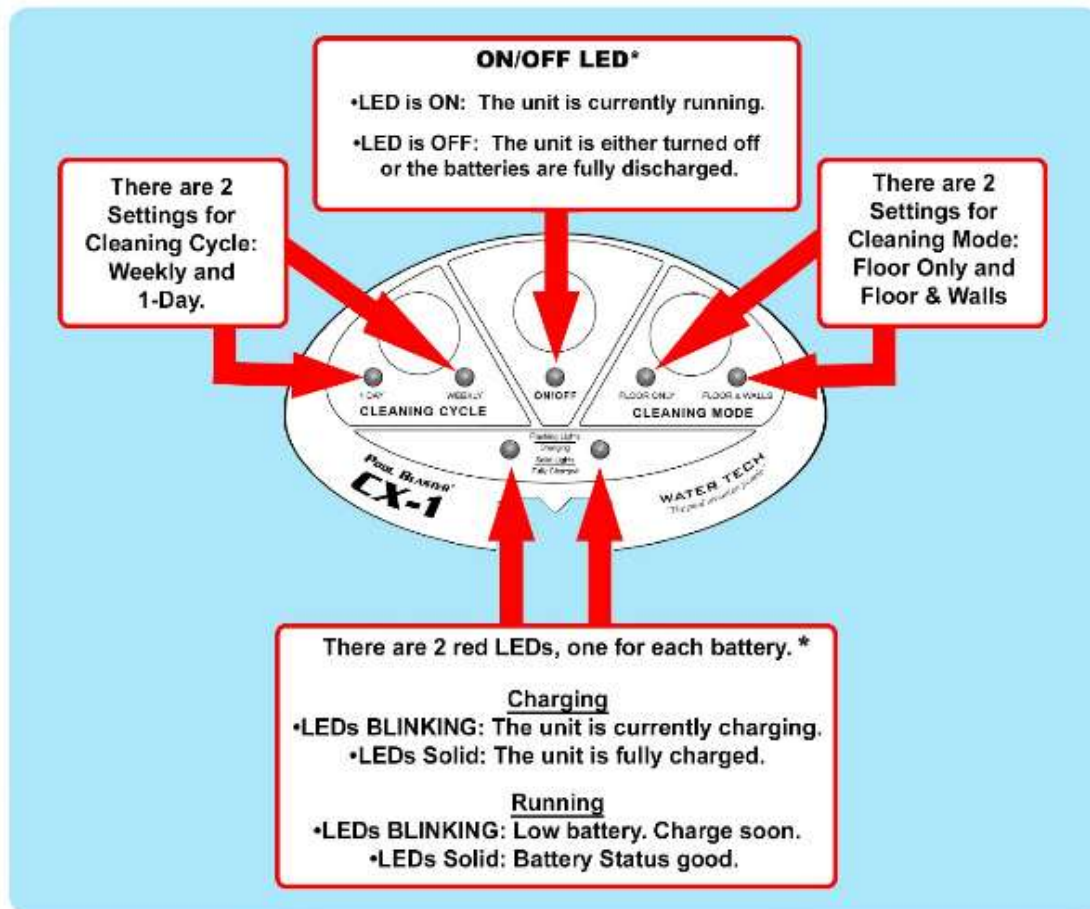

On the next page, you will find more detail on how each mode and cycle works.

**Note: When your CX-1 is in sleep mode, only the ON/OFF LED & Battery LEDs will stay on.*

Smart Features

No matter which modes are chosen, these smart features are included into the software:

- **Upside-down:** The CX-1 is fully capable of detecting when it is upside-down and can then reorient itself to continue cleaning. It also has a feature where, if it cannot flip itself over (such as if it is stuck on an obstacle or too full of heavy debris), it will shut itself OFF to avoid wasting energy from the batteries. When this happens, you can flip over your CX-1 and it will start cleaning again.
- **Out of water:** The CX-1 can detect when it is in or out of water and will avoid wasting energy when it is out of the water. It will also drive itself back into the water, which is especially useful for beach style pools or pools with steps. If the CX-1 is out of water for too long, it will shut itself down (with the LEDs still ON). To continue operation you must turn it OFF and ON again.
- **Cleaning Path:** The CX-1 is programmed with a completely unique cleaning path that will fit any non-commercial size, shape, and style of pool.



a. Select Cleaning Cycle

The CX-1 has 2 different cleaning cycles and 2 different cleaning modes.

- **Cleaning Cycles:** You can choose whether to run the CX-1 continuously until the battery is fully discharged, or have the CX-1 run periodically over a week long period.

1-Day Cleaning Cycle

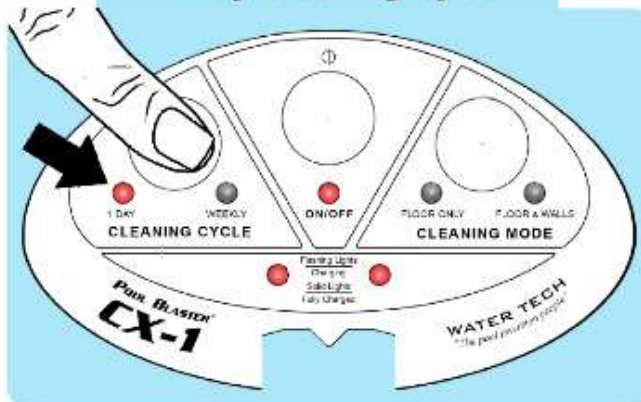

- **1-Day:** The CX-1 will run continuously until the battery is fully discharged. The CX-1 will run up to 4 hours. This mode is most effective for thorough cleaning of a dirty pool.

Weekly Cleaning Cycle

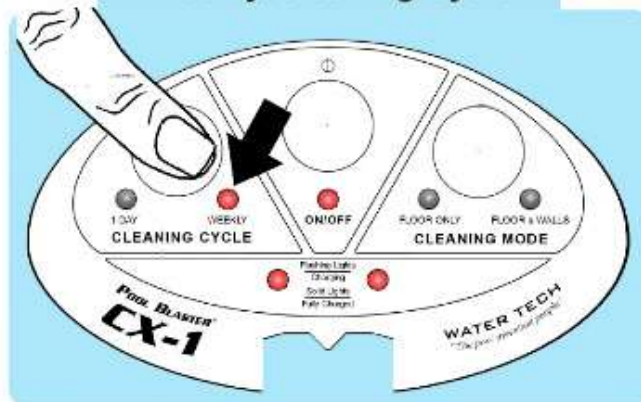

- **Weekly:** The CX-1 will run on a schedule (illustrated on next page) that will end after 7 days, at which point the battery will be fully discharged. This mode is most effective for maintaining a clean pool as it will clean the debris that slowly accumulates throughout the week.

Sleeping during Weekly Cleaning Cycle

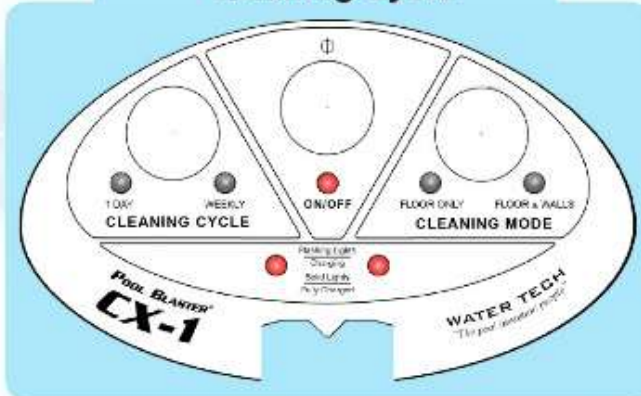

- **When in sleep mode,** both Cleaning Mode and Cleaning Cycle LEDs will turn off. Only the ON/OFF LED and the battery LEDs will stay on for the entire time that the robot is in sleep mode. You can leave the CX-1 in your pool while it's in sleep mode. If you take your CX-1 out of the pool, make sure you place it facing the pool so it can drive itself back in when it wakes up.



Weekly Cycle Running Schedule

Weekly cycle runs your robot every day for a full week. Starting from when you first turn it on, the robot will clean approximately 60 minutes. Then at the same time every day for the remainder of the week, the robot will run for approximately 30 minutes.

Day 1	Day 2	Day 3	Day 4	Day 5	Day 6	Day 7
60 MINS.	30 MINS.	30 MINS.	30 MINS.	30 MINS.	30 MINS.	30 MINS.* <small>(actual runtime may vary)</small> REMOVE FROM POOL TO CHARGE

b. Select Cleaning Mode

- **Cleaning Modes:** The CX-1 is equipped with tilt sensors to help achieve the customer's desired cleaning mode.

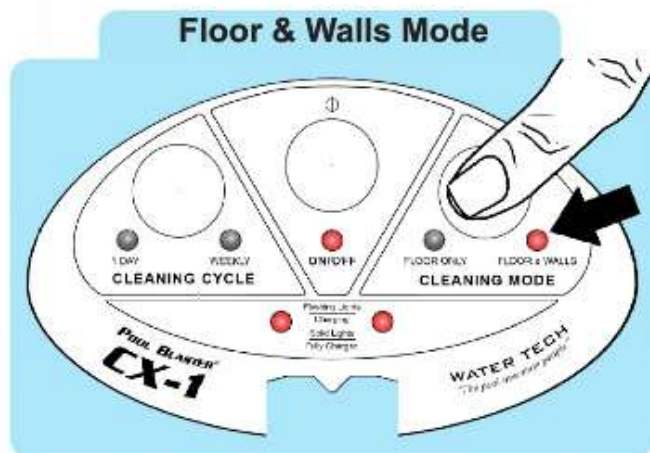

- **Floor & Walls** – The CX-1 will clean the floors and climb the walls, enabling the CX-1 to scrub the waterline.

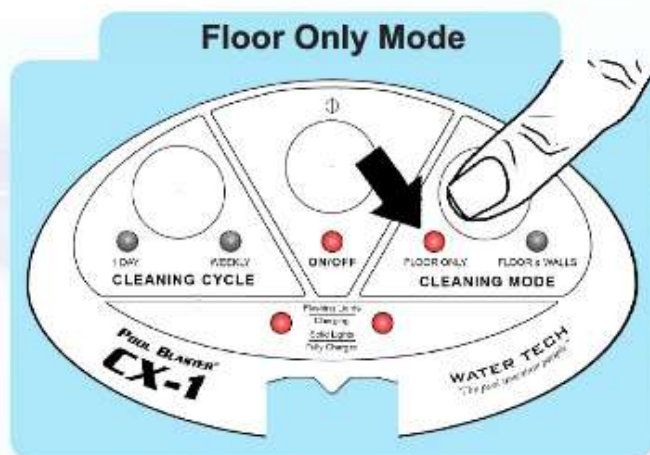

- **Floor Only** – The CX-1 will stay on the floor, picking up debris and scrubbing scum. It will partially climb the walls enough for it to clean the hard to reach edges along the bottom of some pools.



Prepare the Cleaner for Use

a. Charging your cleaner

CHARGING TIME: 6-8 HOURS

Be sure to charge in a dry, shaded area.

The robot cannot be charged while in the pool. But the robot can be charged immediately after removing from the pool. Just make sure that the pins of the robot's charging jack are dry before plugging in the charger.

(The CX-1 will not run when the charger is plugged in).

DO NOT charge outside of the accepted temperature range: 41 to 113°F (5 to 45°C)

DO NOT use extension cord or power strip.

DO NOT expose charger to water or direct sunlight.

DO NOT leave unit plugged into charger for extended periods of time.

DO NOT leave unit plugged into charger during long term storage.

ONLY USE the charger that came with the unit.

Charger

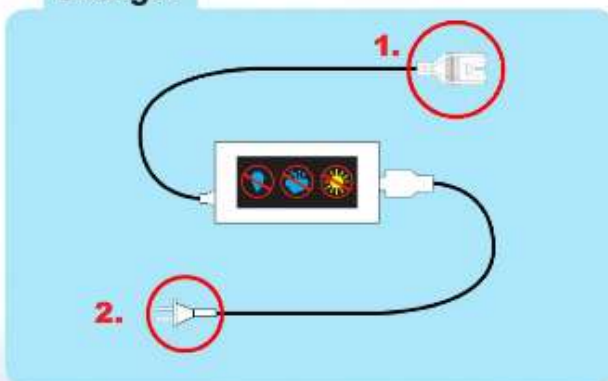

- End #1: To unit's charging jack.
- End #2: To an Indoor Grounded Residential power source.

Unit's Charging Jack

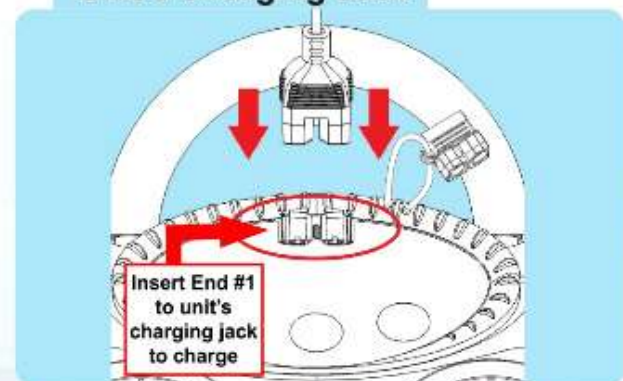

Make sure there is no water present on the pins of the Unit's charging jack.

Battery Packs Charging (Flashing)

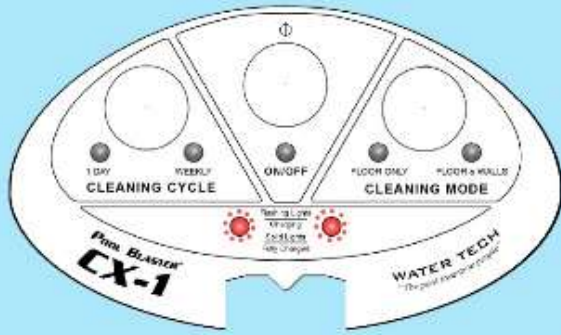

As both battery packs are charging, the LEDs (shown above) will flash.

Battery Packs Charged (Solid)

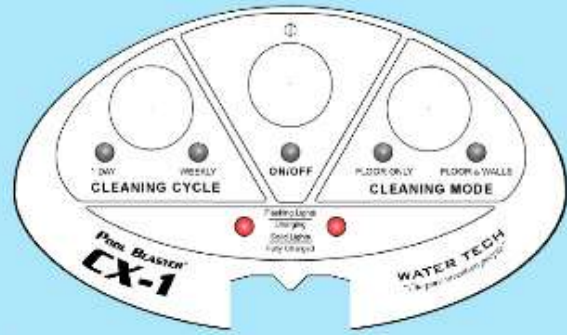

Once a battery pack is fully charged, its LED will turn solid.

If one or both LEDs are not flashing or do not turn solid, contact Water Tech Customer Service.

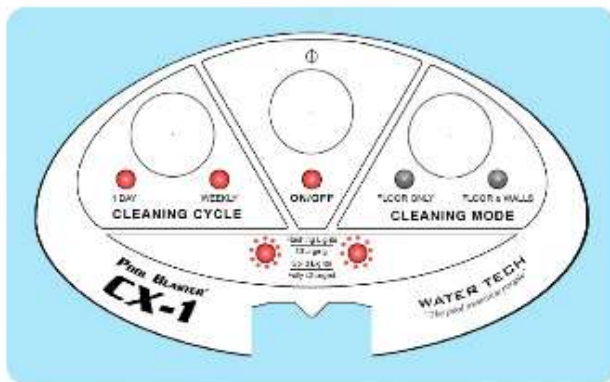

If the CX-1 is charging with the Power (ON/OFF) Button turned ON, the "1-Day", "Weekly", and "ON/OFF" LEDs will be ON (as shown on the left). The CX-1 will not be able to operate until the Power (ON/OFF) Button is turned OFF and then back ON. If you notice these LEDs are ON during charging, it is recommended that you turn the Power (ON/OFF) Button OFF.

**This is a safety feature to ensure that the CX-1 does not turn itself ON while charging or shortly after unplugging the charger.*



Prepare the Cleaner for Use

b. Filter Bag mounting

Closed Cover

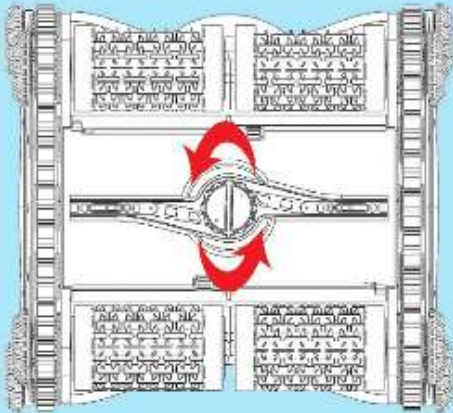

To remove the Filter Bag, flip the CX-1 upside-down and turn the knob on the bottom counter-clockwise.

Unlocked Cover

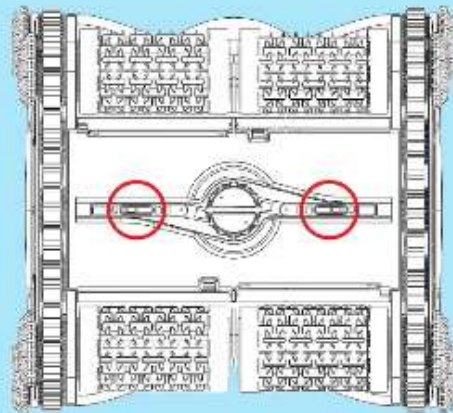

You will feel the knob “snap” as the lock is undone. Note that the locks will move inwards. This means the cover is unlocked.

Filter Bag & Cover (Out)

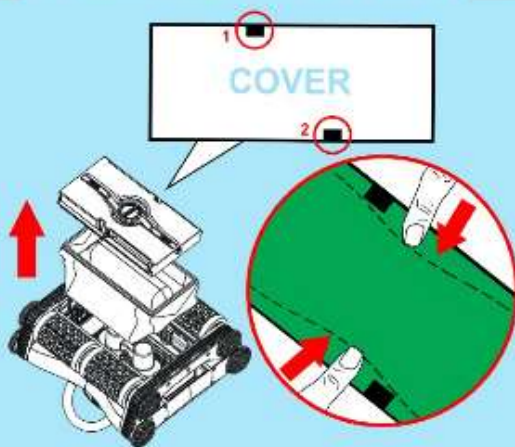

Pull out the entire bottom cover. The filter bag will be locked by the locking tabs inside the cover (Illustrated above as #1 and #2). To remove the filter bag, carefully push the filter bag out of the locking tabs.

Filter Bag

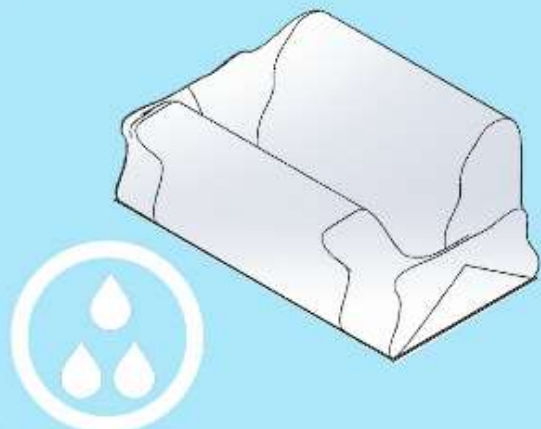

Remove the bag and rinse out with a hose or in a sink.



Filter Bag & Cover (In)

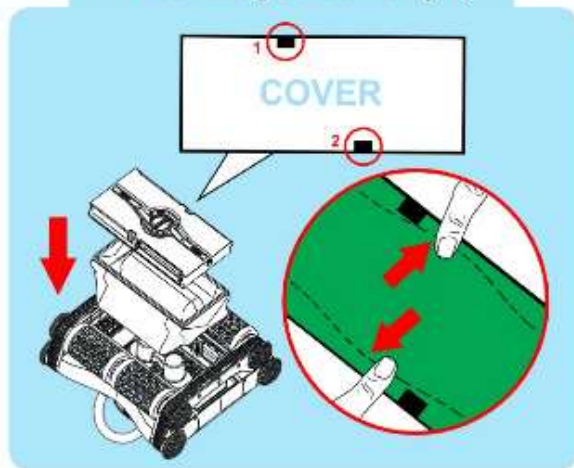

Re-insert the filter bag with the cover on top. Make sure you lock the bag under the two locking tabs (Illustrated above as #1 and #2). Then, insert bag into unit as you lower the cover into place.

Lock Cover

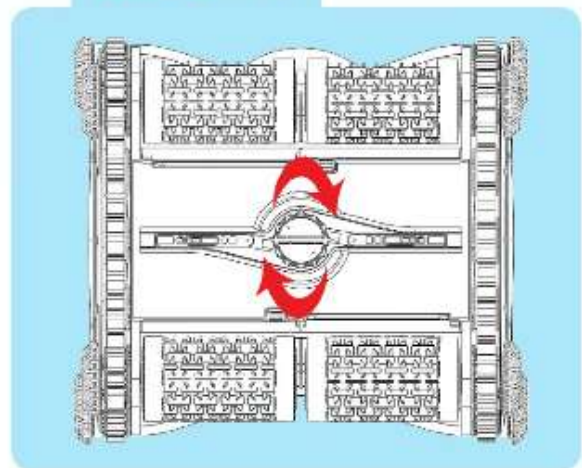

Turn the knob clock-wise to lock the cover. You will hear a “snap” again as the cover locks.

Closed Cover

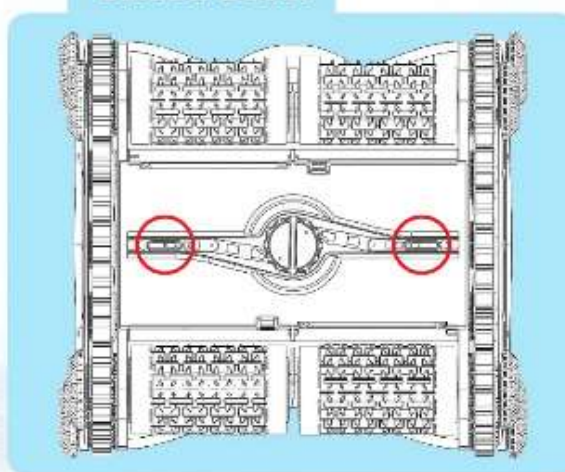

The locking tabs will move outwards.
This means the cover is locked.



Start Cleaning

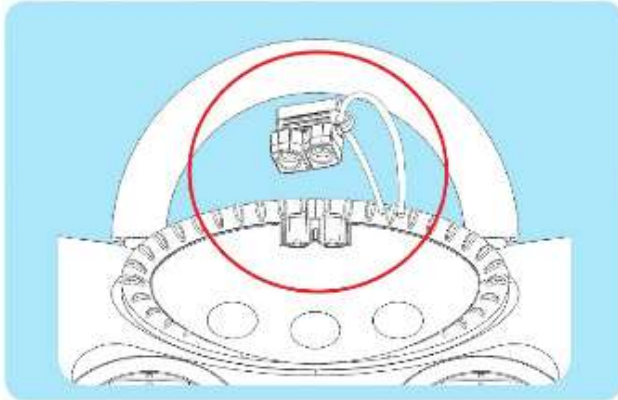

When the CX-1 is done charging, it's important that you **DO NOT** submerge the CX-1 in water without replacing the rubber plug covering the charging jack. Failure to follow this step could damage your unit.

Aim at the pool

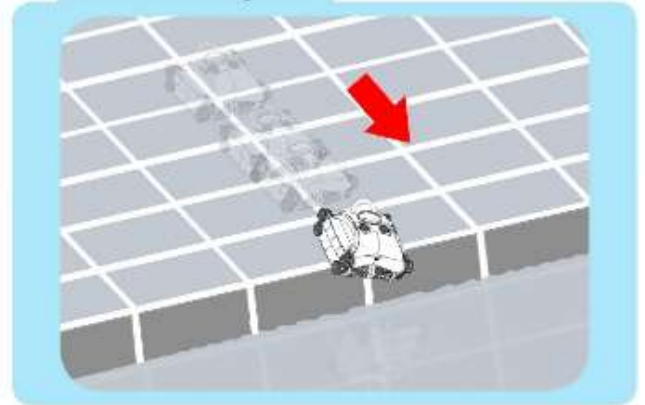

Aim the CX-1 at the pool (place robot roughly 3 ft. from the edge of the pool).

For above ground pools, drop the robot in the pool after selecting your desired settings

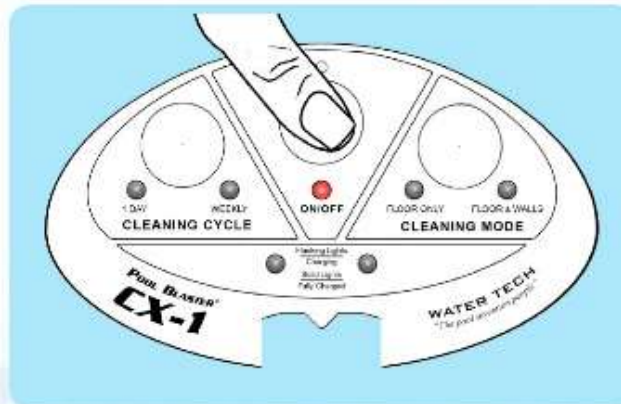

Push the ON/OFF button and select your desired Cleaning Cycle and Cleaning Mode.

(After the robot is turned on, you will have 10 seconds to select your desired Cleaning Mode and Cleaning Cycle shown on Page 7-8)

Retrieval After Use

Cleaner can stay in the pool for up to 7 continuous days, even with the battery fully drained.



Warning! Risk of Drowning!

NOT a life saving device. Never allow children or persons who cannot swim to use this product. This product is designed to be used around a residential swimming pool and a person who cannot swim can drown if they accidentally fall into the pool while using or retrieving this product.

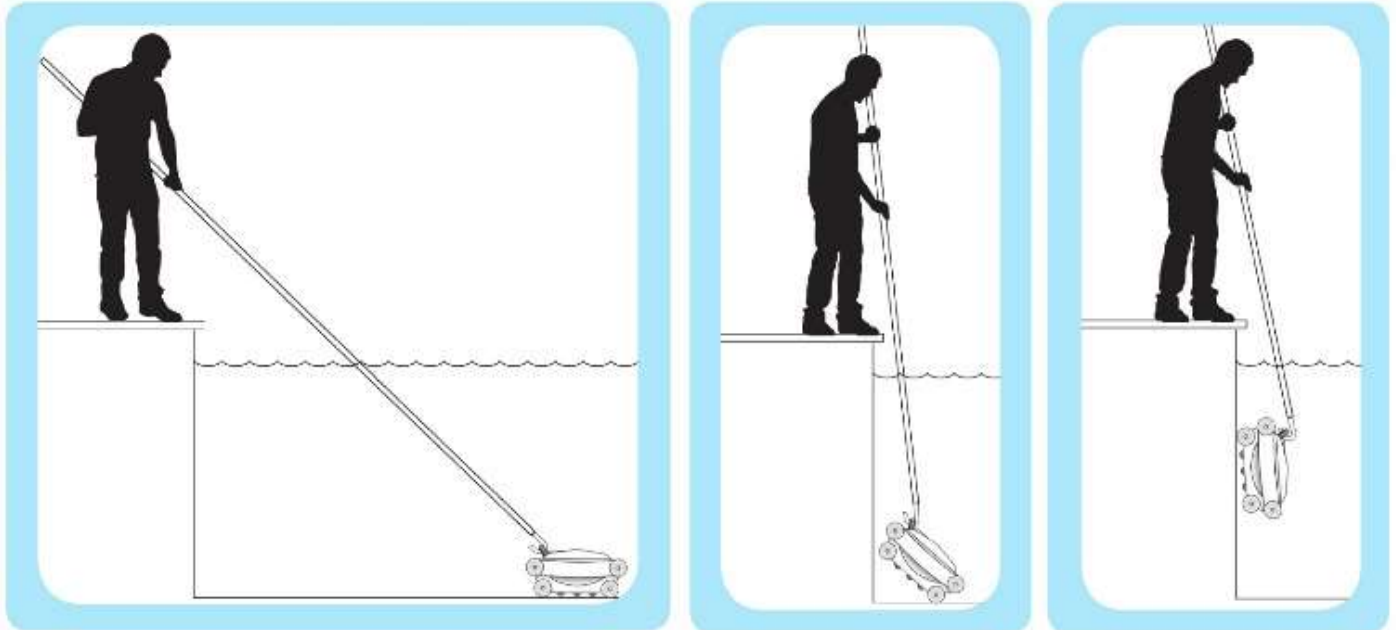

Lift the CX-1 to the surface using a slow, steady pulling motion. Remember, the CX-1 is heavy while full of water.

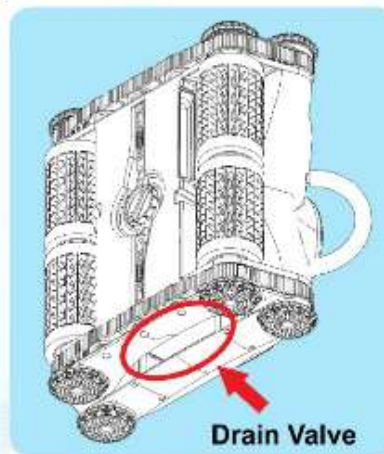

Rest the CX-1 on the edge of the pool to allow water to drain from the drain valve. Turn the power switch OFF when removing from pool, even if the batteries are fully discharged.



Owner Performed Maintenance

a. Filter Bag

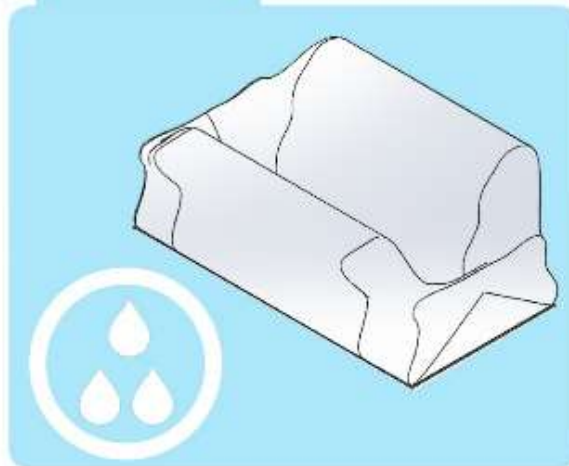

Always remove and clean the filter bag after every use. Do not store the unit with a dirty filter.

b. Filter Screen

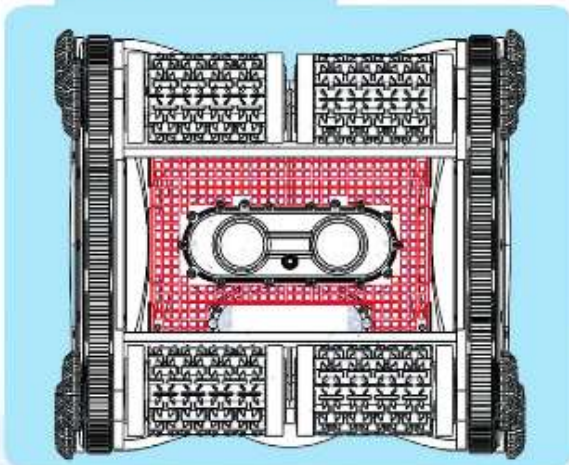

Check the filter screen (Highlighted in red above) for any debris that may have escaped the filter bag. It is recommended to occasionally clean the inside of the unit with a hose.



c. Cleaning bottom cover

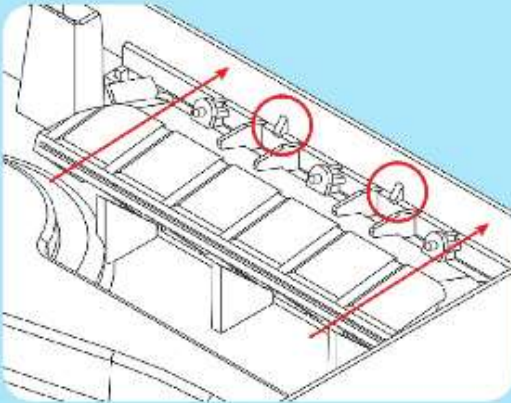

1. Press outward on the bottom cover so the valve mount can fit around triangular tabs (shown circled above).

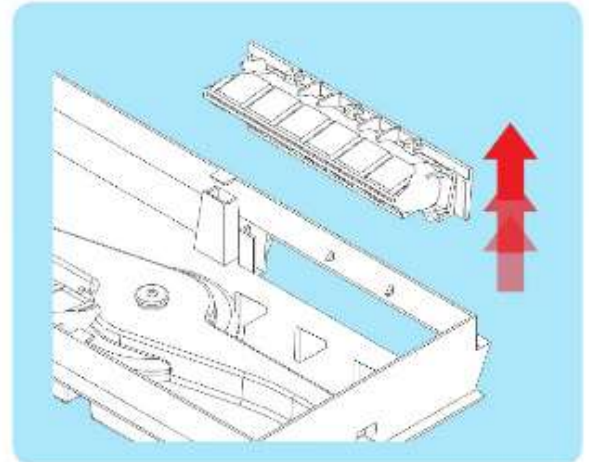

2. While still pressing outward, lift the valve mount up and out of the bottom cover. Rinse out the valve mounts and bottom cover.

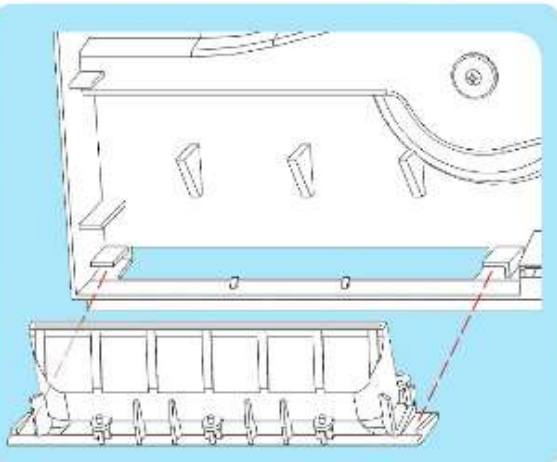

3. Align the valve mounts with the bottom cover and press down into place.

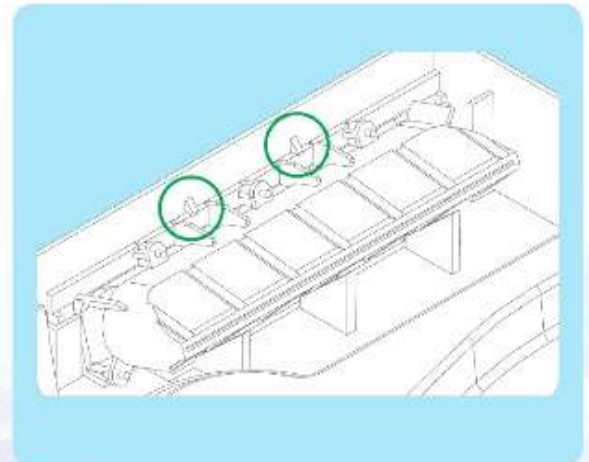

4. Press until triangular tabs snap back over valve mounts.



CAUTION: Make sure the unit is turned **OFF** before performing maintenance to impellers!

d. Impeller Maintenance

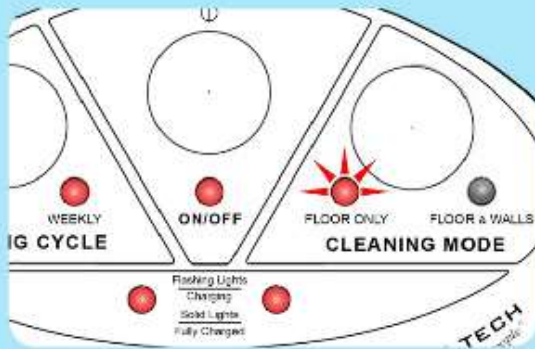

1. It is important to routinely check for debris trapped in the impeller. The “Floor Only” LED on the control box will start flashing if the unit detects that there is significant debris in the impellers.

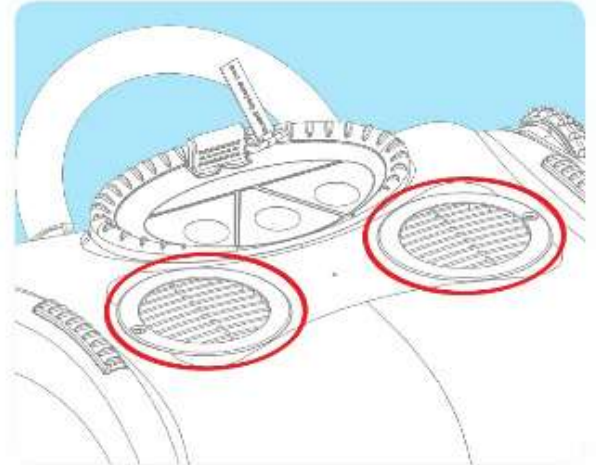

2. Look down at the unit from the top and check for debris around the impellers (circled above).

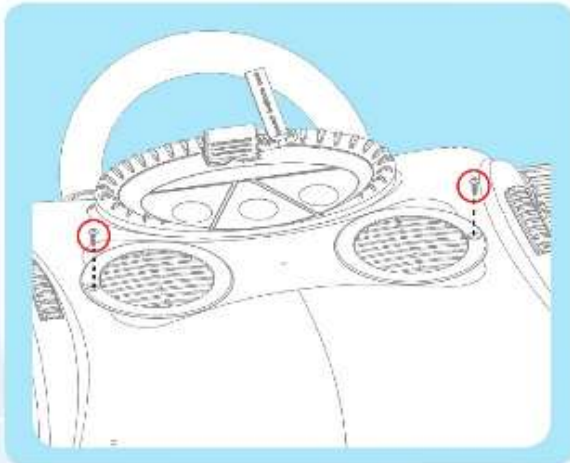

3. If you notice any debris around the impellers, then follow these steps. Use a screwdriver to remove the small screw used to hold in the cover.

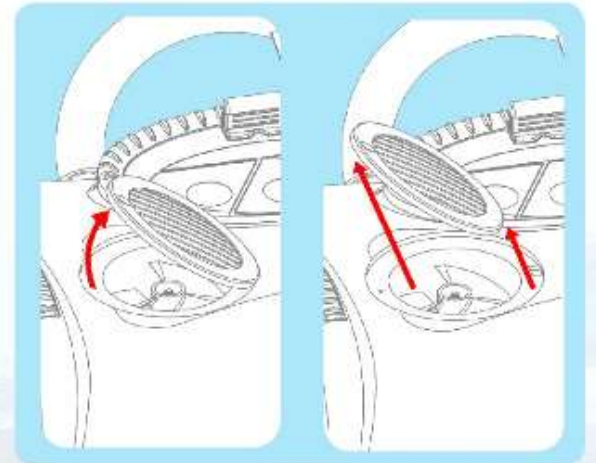

4. Tilt the cover. Lift away from the unit.



CAUTION: Make sure the unit is turned **OFF** before performing maintenance to impellers!

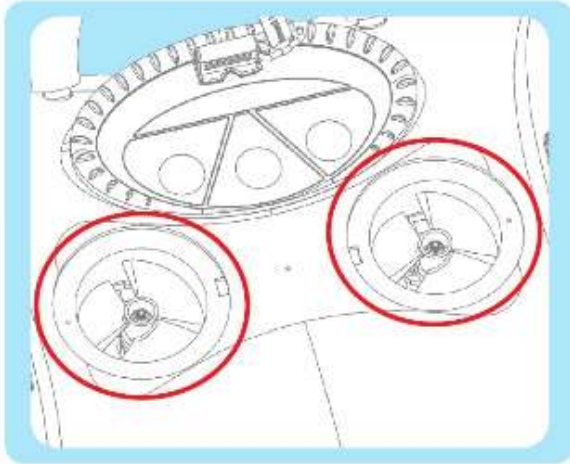

5. Check inside for any debris and remove the debris by hand.

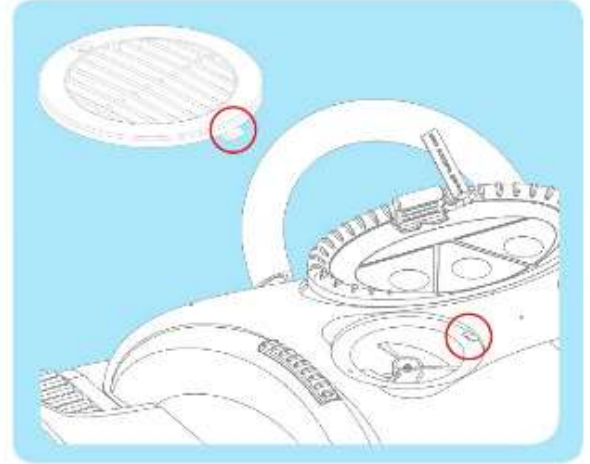

6. Reassembling Covers: Insert the tab of the cover into the slot on the top of the unit.

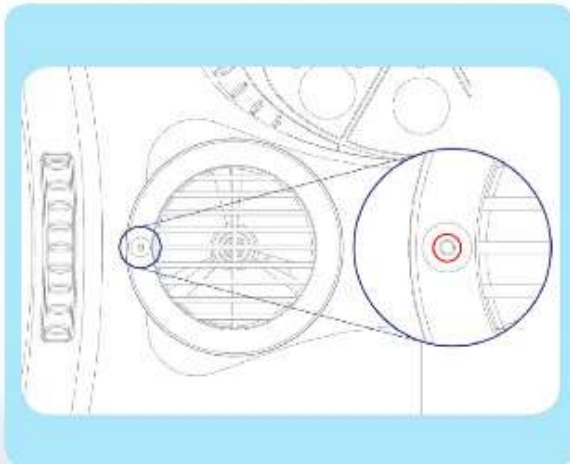

7. Align the screw hole of the cover with the screw hole on the top of the unit.

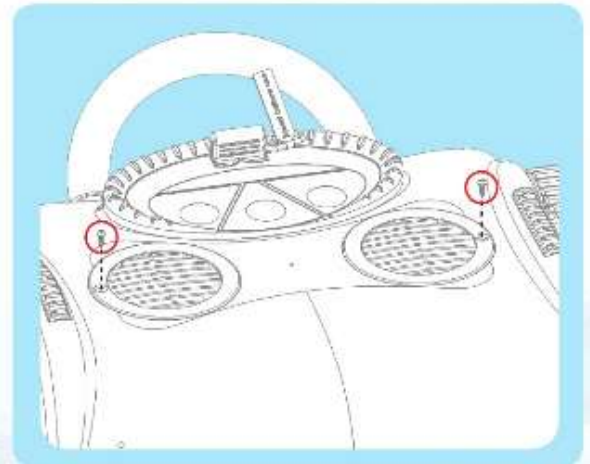

8. Tighten the small screw into the screw hole mentioned above.



e. Long Term Storage

- Before long term storage, run the CX-1 until the batteries are fully discharged. Then use the chart below to charge the batteries the appropriate amount before storing.

Number of Months to be Stored	3 Months	6 Months	9 Months
Number of Hours to be Charged	Charge for 1.5 hours	Charge for 2 hours	Charge for 2.5 hours

- The CX-1 must be stored at a temperature between 41 to 113°F (5 to 45°C).
- After 9 months of storage, charge the batteries for 2 hours every 6 months.
 - Always store your CX-1 in a cool, dry, indoor shelter.
 - Don't leave the CX-1 plugged into the charger.
- At the start of the next season, charge the robot and make sure **BOTH BATTERIES LEDs** start flashing while charging.

If one or both LEDs are not flashing, contact Water Tech Customer Service.



CX-1 Calibration Procedure

Only follow the instructions below if instructed to by Water Tech or the Troubleshooting / FAQs section.

Make sure that the batteries are FULLY CHARGED and the unit is OUT OF WATER before calibrating.



Calibration Procedure: Read all instructions before attempting to calibrate robot.

1. Turn ON the robot.

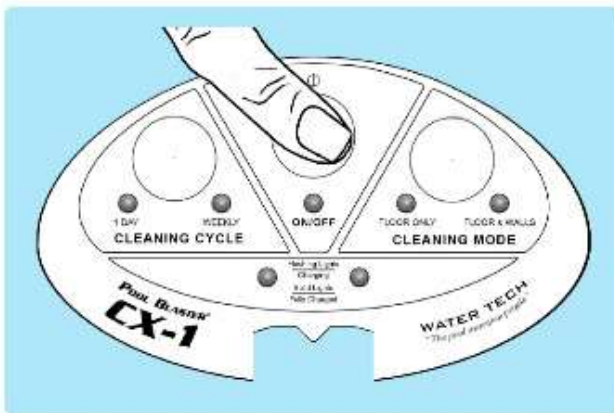

2. Within 5 seconds of turning the robot ON, press the "Cleaning Mode" button 5 times.

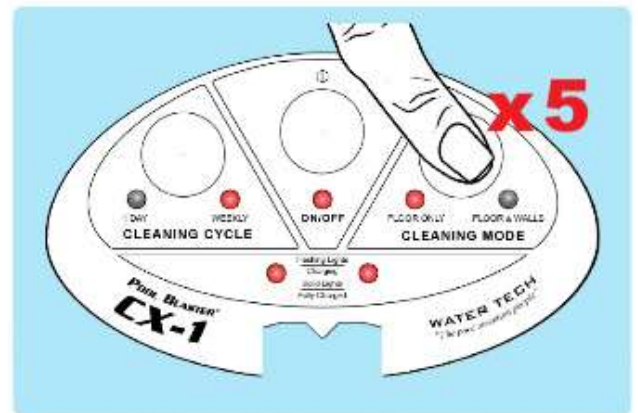

3. The "Floor Only" LED light will flash rapidly to indicate proper entry.

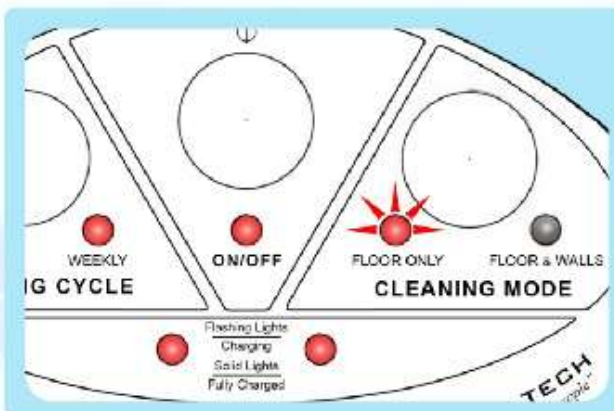

4. Wait for the "Floor Only" LED to stop flashing, then press the "Cleaning Mode" button one time.



5. The pump will turn ON immediately after pressing the button.
- a. If the pump does not turn ON. Turn the robot OFF and try again.

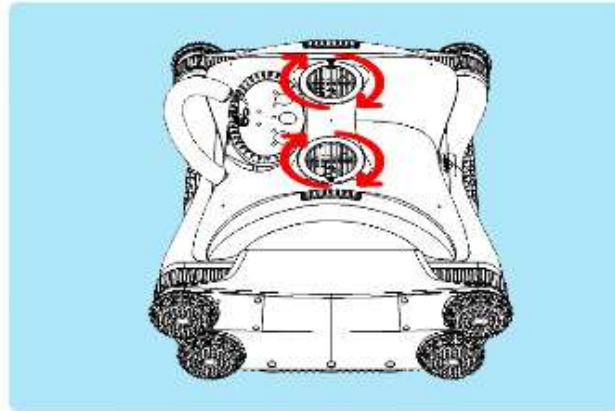

6. Once the pump turns OFF, the robot has been calibrated. It is now OK to turn the robot OFF or place it by the pool and it will automatically turn ON within 5 seconds.

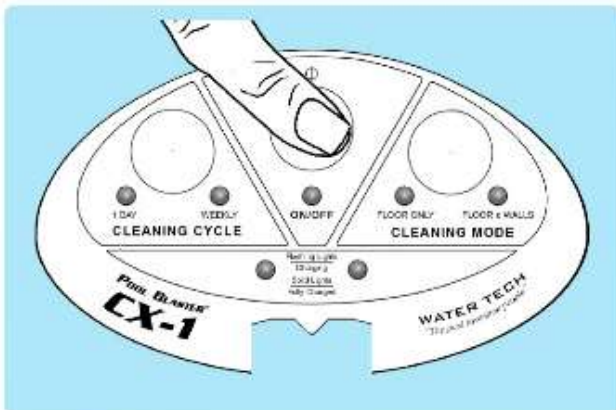

(Turning robot OFF)

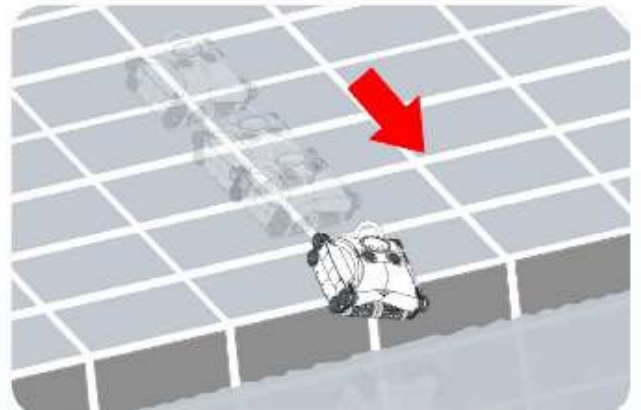

*(Aiming robot at pool)
(For above ground pools, drop the robot in)*



CX-1 Troubleshooting

- **“Floor Only” LED is flashing rapidly, and the robot is not moving.**
 1. Pump motor might be jammed:
 - Turn the power OFF; check the impellers for visible obstructions. If any obstruction can be seen, refer to page 17 for further instructions.
 2. Robot may need calibration. Follow the instructions on page 20 for calibration.
 3. If the problem persists, contact Water Tech Customer Service.
- **LED’s are flashing erratically and/or not changing properly after pressing buttons.**
 1. Contact Water Tech Customer Service regarding a “Control Box” issue.
 2. Do NOT attempt to charge batteries or use the cleaner.
- **If:**
 1. One or both battery LEDs are not turning on during use.
 2. One or both battery LEDs are not turning on during charging.
 3. One or both battery LEDs are not turning solid during charging.
 4. One or both battery LEDs are flashing immediately after a full charge.
 5. Robot is only running for 2 hours or less on a full charge.
 - Contact Water Tech Customer Service regarding a “Battery” issue.
- **Robot NOT Moving, power is ON, (and not in sleep mode).**
 1. Robot may need calibration.
 - See page 20 for calibration instructions.
 2. If the problem persists, contact Water Tech Customer Service regarding a “Control Box” issue.
- **Robot keeps cleaning after day 7 of the “Weekly” cycle.**
 1. Robot may need calibration.
 - See page 20 for calibration instructions.
 3. If the problem persists, contact Water Tech Customer Service regarding a “Control Box” issue.
- **Pump Motor or Drive Motor(s) stops working.**
 1. Contact Water Tech Customer Service regarding a “Replacement Motor”.
- **Robot appears to be slowing down.**
 1. Rinse / clean out the inside of the robot.
 2. Check alignment of brushes.
 - Rotate Brushes. The brushes, track belt and outer wheels should rotate in sync.
 3. If the problem persists, contact Water Tech Customer Service regarding a “Drive Motor” issue.
- **Robot appears to be losing suction.**
 1. Clean out the filter bag.
 2. Use a hose to rinse out the inside of the robot. Check the “Screen” for any debris, as shown in page 15 in the manual.
 3. Robot may need calibration.
 - See page 20 for calibration instructions.
 4. If the problem persists, contact Water Tech Customer Service regarding a “Replacement Motor”.
- **Robot is driving away during charging.**

Contact Water Tech Customer Service regarding a “Control Box” issue.



CX-1 Troubleshooting

- **Robot is not moving and “1-Day”, “Weekly”, “ON/OFF”, and Battery LEDS are all ON:**
 1. Turn the robot OFF and ON again using the Power (ON/OFF) Button.
 2. Refer to page 10 for more information.
- **Robot appears to be driving in circles or driving back and forth over the same area.**
 1. Robot may need calibration.
 - See page 20 for calibration instructions.
 2. If the problem persists, contact Water Tech Customer Service regarding a “Control Box” issue.
- **Robot is stuck upside-down in pool.**
 1. Flip the robot over – it should start back up immediately.
 2. Batteries may be fully discharged and the robot will not turn back ON.
 3. If the problem persists, clean out the filter bag and rinse the inside of the robot.
 4. Otherwise contact Water Tech Customer Service regarding a “Control Box” issue.
- **Robot is not covering the entire pool.**
 1. Try using different launch points: the robot has a tendency to spend more time in the deep end of most pools. We recommend launching the CX-1 in the shallow end.
- **Filter Bag is not staying secure to bottom cover during use.**
 - Clean out the filter bag and bottom cover thoroughly.
 - If the problem persists, contact Water Tech Customer Service regarding a “Replacement Bottom Cover”.
- **Robot is driving around with the pump turned OFF.**
 - It is perfectly normal if this happens just after the robot falls off a wall.
 - If this issue occurs more frequently, the robot may need calibration, See page 20 for instructions
 - If the problem persists, contact Water Tech Customer Service regarding a “Control Box Issue”.

CX-1 FAQs

- **Can I leave the robot in the pool?**
 - Yes, the robot can stay in the pool for up to 7 days, even with the battery fully depleted.
- **Can I leave the robot on the charger?**
 - Yes, the robot can stay plugged into the charger for up to 7 days. However, the robot **MUST** be charged in a DRY, SHADED AREA. Leaving the charger in water or direct sunlight **WILL** damage the charger and VOID the warranty.
- **Can I remove the robot before it has finished a full cycle?**
 - Yes, the robot can be removed from the pool at any time. Please remember to turn the robot OFF when removing from the pool, or leave it facing the pool when in “sleep mode”.
- **How do I remove the robot from the pool?**
 - The CX-1 includes a hook which can be mounted to any standard pool pole. Use the hook to pick the robot up by the rubber handle. Refer to page 14 of the manual for more information.



CX-1 FAQs

- **Can I unplug the charger before the robot is fully charged?**
 - Yes, just note that the runtime will be decreased.
- **Why won't it clean my carpet?**
 - Because your robot is a water filtering machine for pools.
- **Can I charge the robot in the pool?**
 - No, absolutely not! ALWAYS remove the robot from the pool and charge in a DRY, SHADED AREA.
- **Can I charge the robot immediately after taking it out of the pool?**
 - Yes, just make sure the pins of the unit's charging jack are dry.
 - Charge the robot in a dry, shaded location.
- **Can I turn the robot ON while charging?**
 - No, the robot has safety features to prevent it from turning ON while charging. If the robot does turn ON during charging, contact Water Tech Customer Service.
 - **DO NOT ATTEMPT TO SUBMERGE THE ROBOT IN WATER WHILE IT IS CHARGING!**
- **How do I know if the robot is fully charged?**
 - The two lights for the batteries will flash while charging and stay ON when fully charged.
 - A full charge will take roughly 6-8 hours.
- **How do I know if the battery is fully discharged?**
 - When all lights are OFF, the robot is fully discharged.
- **There are 2 lights blinking on the robot, what is wrong?**
 - When the 2 lights for the batteries are blinking, the battery power is low. Refer to page 6 for familiarization with the Control Panel.
- **Why is the robot climbing the walls in floor only mode?**
 - When in floor only mode, the CX-1 will climb the walls just enough to go parallel with the wall. This helps the robot better reach debris along the edge of the floor and wall.
- **How often should I clean the filter?**
 - Clean the filter after every use or more frequently as needed when you notice one of the following:
 - Difficulty picking up debris.
 - Difficulty flipping over when upside-down.
 - Clouds or small debris coming from the exhaust.
- **I put the robot in "Weekly" Cycle and now only 3 lights are ON, why is that?**
 - When in "Weekly" Cycle the robot will clean once a day for 7 days. When it is not cleaning, the robot is in "Sleep Mode" which is indicated by the 3 lights. See Pages 7-8 of manual for more information on "Weekly Cleaning Cycle".
- **I finished charging my robot and now it won't start, all the LEDs except for "Cleaning Mode" are ON.**
 - This a safety feature to prevent the robot from starting accidentally.
 - Turn the robot OFF and back ON using the Power (ON/OFF) Button.
 - Refer to page 10 for more information.



CX-1 FAQs

- **Why are most of these questions already addressed in the manual?**
 - Because nobody reads the manual.
- **How does the CX-1 drive itself into the pool?**
 - Place the robot with the FORWARD arrow pointing TOWARDS the pool. When the robot turns ON, it will drive forward over the edge and into the pool.
 - THIS FEATURE DOES NOT WORK FOR ABOVE GROUND POOLS!
- **What happens if I do not cover the charging jack with the rubber plug?**
 - The charging jack could interfere with the software of the robot and cause strange behavior.
 - Slow discharge of the batteries will occur and shorten the run time.
 - The charging pins will corrode and reduce the life of the robot.
- **How do I store my robot for the winter?**
 - Charge your robot for 1.5 to 2.5 hours before winter storage. Make sure the robot is stored in a cool, dry, indoor shelter. See page 19 for more information on long term storage.
- **Can I run the robot without the filter bag?**
 - No, not intended for use without a filter.
 - Unfiltered debris may jam or obstruct the impeller and/or integral components.
 - If pump motor jammed:
Turn power OFF; check the impellers for visible obstructions. Refer to page 17 for further instructions.
- **Can I leave the robot out in the rain?**
 - If the charger is NOT connected to the robot, it is safe to leave out in the rain.
 - Charge the robot in a dry, shaded location.
- **My robot is falling off the wall, is this normal?**
 - Yes, when the robot reaches the surface, it is designed to fall off the wall rather than drive back down.
 - This saves energy, and the robot reorients itself after submerging.
- **Can I use my robot to clean a commercial / olympic size pool?**
 - Please be aware, runtime on fully charged battery packs may not be sufficient for commercial / olympic sized pools.
- **Can I open the pool with my CX-1?**
 - The CX-1 is not intended for cleaning a pool just after opening.
 - Once the pool has been properly cleaned after opening, it is safe to use the CX-1.
- **If my robot is in sleep mode and I clean my bag, what will happen?**
 - When the robot is in sleep mode, it is safe to remove it from the pool. After cleaning the filter bag, the robot can be placed poolside and it will drive itself back into the pool when it wakes up. Please note that impeller maintenance should NOT be done when the robot is in sleep mode. Please refer to page 17 for more information on impeller maintenance.
- **What happens if I store my unit when fully charged?**
 - Li-Ion batteries are not meant to be stored for long periods of time at full charge. This can cause the battery to lose capacity which results in lower runtime of the robot.



**10 Alvin Ct., Suite 111
East Brunswick, NJ 08816 - USA
Tel: 732-967-9888 US, Canada & International
Fax: 732-967-0070 US & International
www.WaterTechCorp.com**



Register at www.watertechcorp.com/register

Water Tech's Customer Service

P: 800-298-8800 (U.S.A. / Canada)

Rev.: 512019