

Johny Vac
Xclusiv
series



USER GUIDE

XV-10

FILL IN AND RETAIN

The model and serial number are located on the bottom of the cleaner.

For your personal records, please enter the COMPLETE model and serial number in the spaces provided and retain this information.

Your cleaner is model
and has serial number

It is suggested that you attach your sales receipt to this owner's manual. Verification of date of purchase may be required for warranty service of your JohnnyVac product.

INDEX

| | | | |
|--|---|---------------------------------|----|
| 1. IMPORTANT SAFETY INSTRUCTIONS | 3 | 5. CLEANING TOOLS | 7 |
| 2. COMPONENTS & ACCESSORIES | 4 | 6. MAINTENANCE – How to replace | |
| 3. ASSEMBLY | 5 | 6.1. Filter bag | 8 |
| 4. OPERATION | | 6.2. Filters | |
| 4.1. ON/OFF switch | 6 | - Secondary filter..... | 9 |
| 4.2. Check bag indicator | 6 | - Exhaust filter | 9 |
| 4.3. Variable suction control | 6 | 7. TROUBLESHOOTING | 10 |
| 4.4. Wand storage clip | 6 | 8. WARRANTY | 11 |
| 4.5. Polarized plug | 6 | | |
| 4.6. Thermal protector | 6 | | |

1- IMPORTANT SAFETY INSTRUCTIONS

READ ALL INSTRUCTIONS BEFORE USING THIS APPLIANCE

GENERAL

- Use this appliance solely in accordance with these instructions.
- Use solely accessories recommended by the supplier. The use of other accessories may result in damage to the appliance, thereby creating hazards for the user.
- This appliance is not intended for use by persons (including children) with reduced physical, sensory or mental capabilities, or lack of experience and knowledge, unless they have been given supervision or instruction concerning use of the appliance by a person responsible for their safety.
- Children should be supervised to ensure that they do not play with the appliance.
- Have any repair carried out solely by a qualified electrician. Never try to repair the appliance yourself.

ELECTRICITY AND HEAT

- Verify that the mains voltage is the same as that indicated on the type plate on the appliance before use.
- Always remove the plug from the socket when the appliance is not in use.
- Always remove the plug from the wall socket by pulling on the plug, not the power cord.
- Check the appliance's power cord regularly to make sure it is not damaged. Do not use the appliance if the power cord is damaged. Have a damaged power cord replaced by a qualified service department.
- When using an extension lead always make sure that the entire cable is unwound from the reel.
- Use solely approved extension leads.
- Avoid stumbling over the extension lead or power cord.
- Make sure the air vent is not covered or blocked.
- Make sure that the appliance and the power cord do not come in contact with sources of heat, such as a hot hob or naked flames.
- Make sure that the power cord and the plug do not come in contact with water.

DURING USE

- Never use the appliance outdoors.
- Never use the appliance in a humid room.
- Make sure that your hands are dry before touching the appliance, power cord or plug.
- The power cord has a yellow and a red mark. Pull out the power cord to the yellow mark. Never pull out the power cord beyond the red mark.
- Guide the power cord whilst it rewinds onto the reel, since otherwise the cord could become tangled or the plug could strike back of the appliance. Take hold of the power cord near the mark, and allow it to gently slide through your fingers back into the appliance.
- Make sure that the dust bag does not become pinched between the cover and the motor unit. This could damage the appliance and/or the dust bag.
- Do not use the appliance to suck up: flowing or burning objects; glass splinters or other sharp objects; residues of plaster, cement, stone, soot and similar; liquids or moist dirt.
- These objects could cause serious damage to the appliance and the filter system, and make it unsafe to use.
- Do not use the vacuum cleaner on wet rugs and carpets.
- Never insert objects in the air-exhaust vent.
- Make sure that the suction and exhaust openings are opened, and that the filters are not blocked. Blockages will cause the appliance to overheat. Switch off the vacuum cleaner immediately! Once you have remedied the problem, wait 20 to 30 minutes to allow the vacuum cleaner to cool down completely. The vacuum cleaner will then be ready for use again.
- Keep the nozzle and the tubes away from the body while the vacuum cleaner is running. This could cause serious injury, for example to the eyes or ears.
- Never roll the appliance over the cord.
- Switch off the appliance and remove the plug from the wall socket in the event of a malfunction during use, and before filling or emptying the appliance, cleaning the appliance, fitting or removing an accessory, or storing the appliance after use.
- Do not pick up the appliance if it falls in to water. Remove the plug from the wall socket immediately. Do not use the appliance anymore.
- Never immerse the appliance, the power cord or the plug in water or other liquid. After washing the filters, make sure they are thoroughly dry before returning them to the appliance

2- COMPONENTS & ACCESSORIES

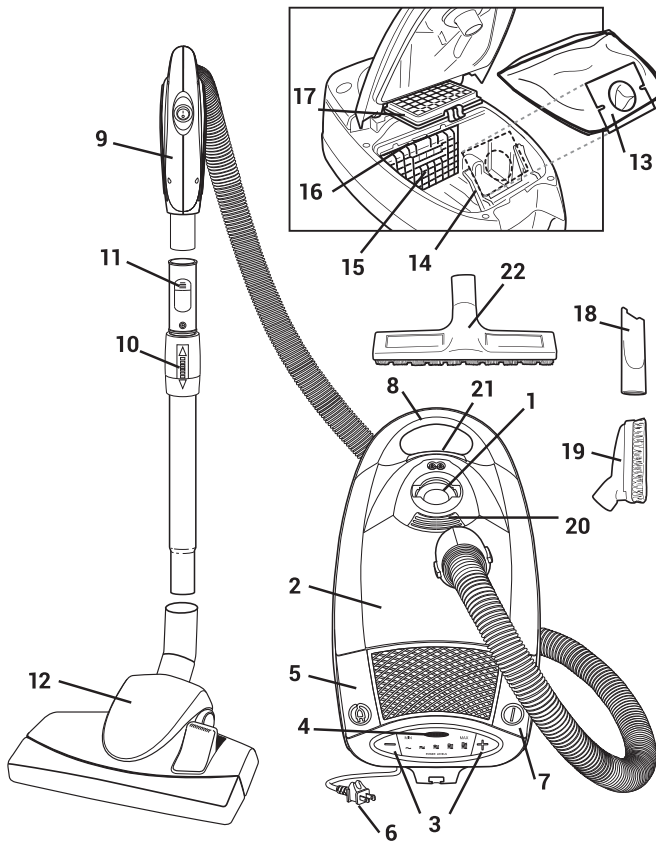

- | | |
|-----------------------------|---------------------------|
| 1. Intake | 13. Disposable Filter Bag |
| 2. Top Cover | 14. Bag Dock |
| 3. Variable Suction Control | 15. Motor Filter Grill |
| 4. Bag Full Indicator | 16. Motor Filter |
| 5. Cordwinder Pedal | 17. Hepa Media Filter |
| 6. Power Cord | 18. Crevice Tool |
| 7. Power ON/OFF Pedal | 19. Combination Tool |
| 8. Carrying Handle | 20. Tool Lid Latch |
| 9. Handle with Hose | 21. Bag Lid Latch |
| 10. Telescopic Wand | 22. Hard Floor Tool |
| 11. Wand Release Latch | |
| 12. Combo Brush | |

3- ASSEMBLY

1. Connect hose by firmly inserting end of hose into canister intake opening.
2. Firmly press handle nozzle into telescopic wand until it locks in place.
3. Insert telescopic wand into combo brush.
4. Extend telescopic wand by holding telescopic wand length adjustment and pulling power handle.

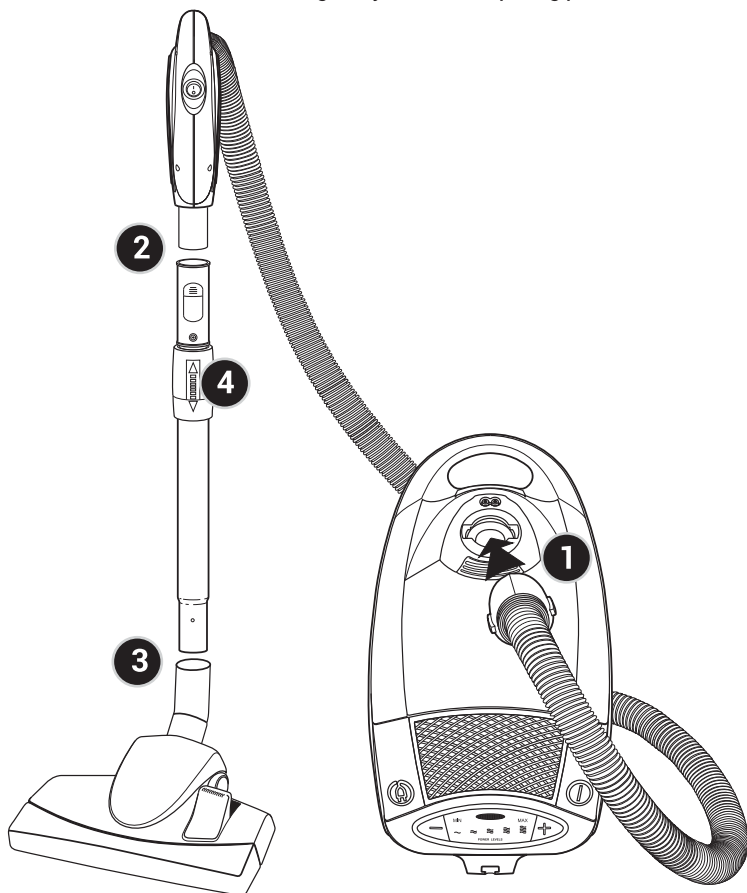

Note : Accessory tools can be used with the telescopic wand or handle alone.

4- OPERATION

4.1

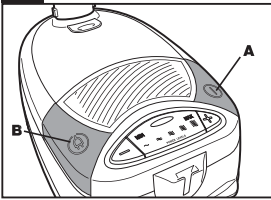

ON/OFF switch

• After assembling vacuum, plug the cord into an electrical outlet. Turn the vacuum ON by pressing the ON/OFF pedal (A). To turn vacuum OFF press the pedal again.

Note : The Cord Winder Pedal (B) is on the other side.

4.2

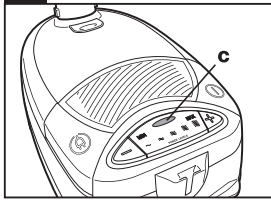

Check bag indicator

• When the indicator light comes on (C), open the canister and check the filter bag. See page 8 for details and instructions on how to replace a filter bag.

4.3

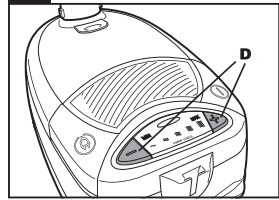

Variable suction control

• The variable suction control (D) is located on the top rear of the canister.

• Push the (-) button to reduce suction and to clean lightly soiled areas or delicate fabrics. Push the (+) button for maximum cleaning power in heavily soiled areas.

4.4

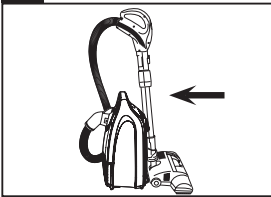

Wand storage clip

• To save storage space, stand the cleaner on end and hook wand storage clip on bottom of cleaner. The nozzle must be positioned down as shown.

• Lift up on wand to remove storage clip from cleaner.

4.5

Polarized plug

• To reduce the risk of electric shock, this appliance has a polarized plug (one blade is wider than the other). This plug will fit in a polarized outlet only one way. If the plug does not fit fully in the outlet, reverse the plug. If it still does not fit, contact a qualified electrician to install the proper outlet.

• DO NOT CHANGE THE PLUG IN ANY WAY.

4.6 **IMPORTANT :**

Thermal protector

• An internal thermal protector has been used in your cleaner to prevent overheating if a large item or clog gets caught in the nozzle or at the opening of the bag.

• When the blockage is not removed, the thermal protector will trip and cleaner will stop running.

• If this happens, turn cleaner OFF and disconnect cleaner from electrical outlet. Then disconnect nozzle and remove obstruction. Within 30 minutes the thermal protector will cool and automatically reset and cleaning may resume.

• If cleaner does not operate, allow additional time for thermal protector to reset.

Note: The canister must remain unplugged during the 30 minute cooling period.

5- CLEANING TOOLS

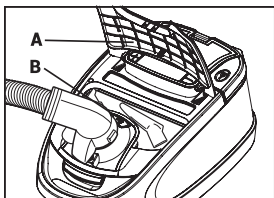

Cleaning tools

- The cleaning tools are conveniently stored in the cleaner underneath the tool lid (A). Push the tool lid release latch to open (B).
- The cleaning tools have many uses. Select the tool best suited for the cleaning task from the following descriptions.

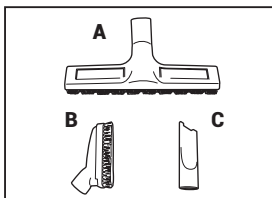

Select the proper tool

A. Hard floor tool may be used for walls and very irregular hard surface floors such as brick and slate.

B. Combination tool may be used for carved furniture, table tops, books, lamps, lighting fixtures, venetian blinds, baseboards, shutters and registers. May also be used for upholstered furniture, draperies, tapestries, mattresses and clothing.

C. Crevice tool may be used in tight spaces, corners, and along edges in such places as dresser drawers, upholstered furniture, stairs and baseboards.

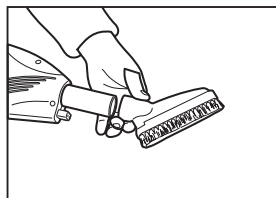

Attaching tools

- Tools may be attached directly to the hand grip or to the wand. Firmly push tool into the hand grip or wand. Twist tool slightly to tighten or loosen connection.

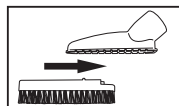

- Slide combination tool apart to reveal second tool.

6- MAINTENANCE

Familiarize yourself with these home maintenance tasks as proper use and care of your cleaner will ensure continued cleaning effectiveness.

6.1 Filter bag

When to replace

- Check the filter bag when the full bag indicator light shows red.
- When the filter bag is filled with dirt, the cleaner will not operate efficiently.
- Discard the used filter bag and replace with a new one.

Caution

The full bag indicator light may come on when picking up fine materials, such as face powder, flour, cornstarch, fireplace ashes or fireplace soot. These materials may seal the pores of the filter bag and may cause the filter bag to burst even though the filter bag is partially full of dirt. It is advised to change the filter bag often when removing material of this nature.

How to replace

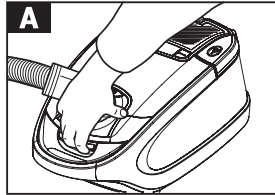

- Disconnect cleaner from electrical outlet.
- Rotate hose to the side, lift bag lid latch and open bag lid.

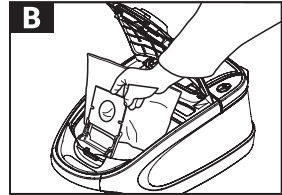

- Carefully pull out used bag.

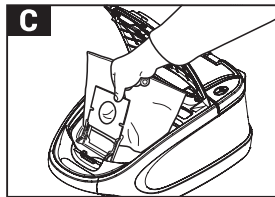

- Form new bag into a box-like shape.
- Slide bag collar **firmly** into holder.

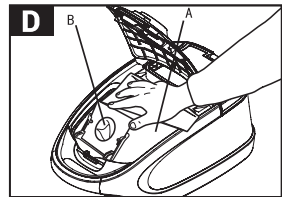

- Push rear edge of bag into bag cavity below seal (A).
- Clear bag opening (B) by pushing the pierced paper through opening toward bag interior.
- Close bag lid.

Note: The canister bag lid will not close without a filter bag in place.

6.2 Filters

Secondary filter

How to clean or replace

- Disconnect cleaner from electrical outlet.
- The **secondary filter**, located behind the grill in the bag compartment, protects the motor from dirt particles. If filter becomes dirty, pull off grill and lift out filter. Wash filter in warm water or replace it with a new one. A **dry filter** must be put back into cleaner.
- **Do not operate cleaner without secondary filter in place.**

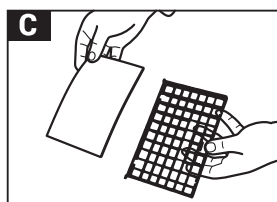
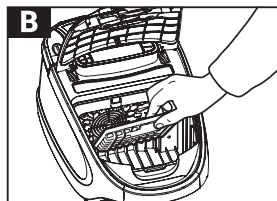
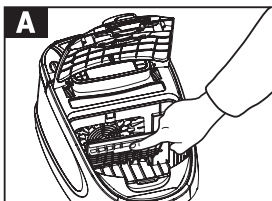

Exhaust filter

How to replace

- The high efficiency exhaust filter aids in the filtration process to return clean air to the room.
- To remove this filter, open the grill located at the back, unsnap the filter latch and pull the filter out.
- Replace with a new filter.

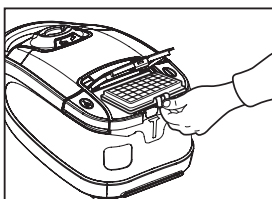

Note: The filter should be replaced annually.

7- TROUBLESHOOTING

CHECK THESE FIRST

Service problems that appear to be major can often be solved easily. You can be your own troubleshooter by reviewing this guide.

| Problem | Check | Solution |
|---|--|---|
| Vacuum does not turn ON | • Power cord | • Plug in power cord. Make sure it is firmly into the wall outlet. |
| | • Power source | • If no power to outlet, check power source, fuse or circuit breaker. |
| | • Hose connection | • Make sure the hose is securely connected. |
| | • Thermal protector | • Allow vacuum to cool per instructions (see page 6). |
| Vacuum has little or no suction | • Filter bag | • Filter bag may be clogged or full. Check and replace if necessary (see page 8). |
| | • Motor filter | • May be dirty or clogged. Clean or replace if necessary (see page 9). |
| | • Hose, wand or accessories may be clogged | • Clear obstruction. |
| | • Hose connection | • Make sure hose is properly connected. |
| Vacuum still does not operate properly | • Review all the above | • Contact your dealer for service. |



FOR
PARTS, ACCESSORIES & VACUUM BAGS

VISIT OUR WEBSITE AT
WWW.JOHNNYVAC.COM



www.johnnyvac.com