

CONFIGURAZIONI HOOP

FORMA E DIMENSIONI MINIME DEL FORO SOLAIO

Dimensione foro: diametro scala + 5 cm

Pianerottolo di arrivo universale con apertura di 60°: adattabile ad ogni foro durante il montaggio e fissato a livello del pavimento del piano superiore.

FORO QUADRATO

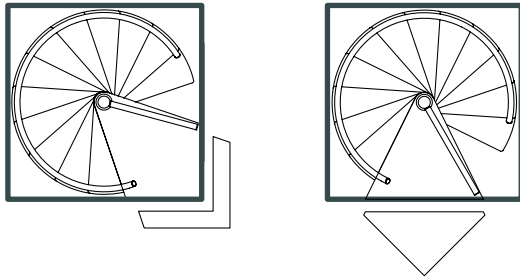

FORO TONDO

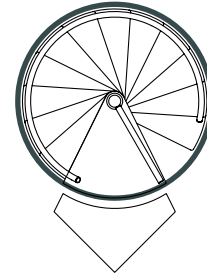

FORMA E MISURE DELLA SCALA

Diametro 118 cm

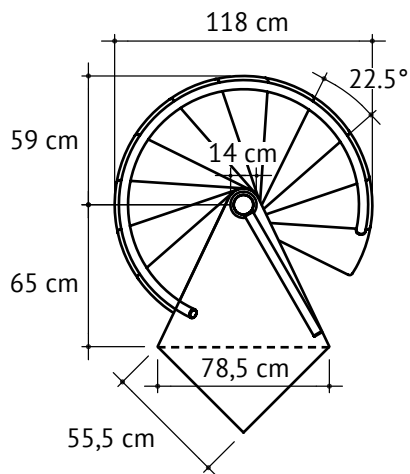

Diametro 138 cm

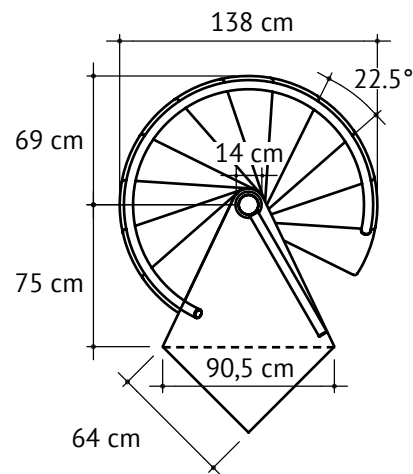

SCHEMA DI VERIFICA AREA ENTRATA E AREA USCITA RISPETTO ALLA POSIZIONE DELLE PARETI

NON
CORRETTO

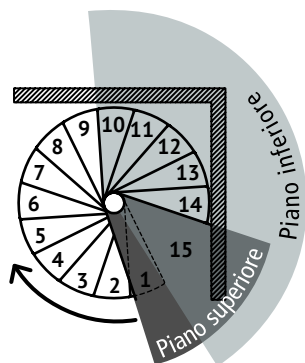

CORRETTO

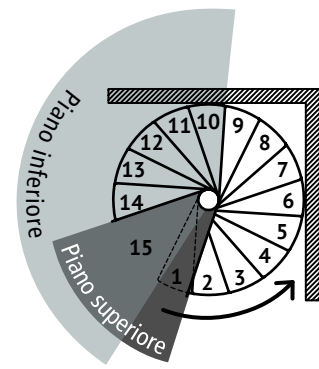

Nel caso in cui il primo gradino dal basso non sia accessibile prova, se possibile, a spostare il punto di arrivo, a invertire il senso di rotazione o ad aggiungere o togliere gradini.

POSSIBILI CONFIGURAZIONI DELLA SCALA

Attraverso le seguenti configurazioni è possibile determinare il senso di salita, l'accesso alla scala dal piano inferiore e dal piano superiore in base al numero di gradini.

10 GRADINI pianerottolo incluso (10 ALZATE)
Altezza tra i piani: Min. 205 cm - Max. 240 cm

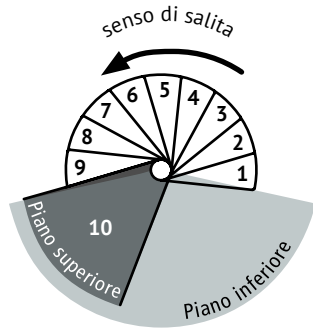
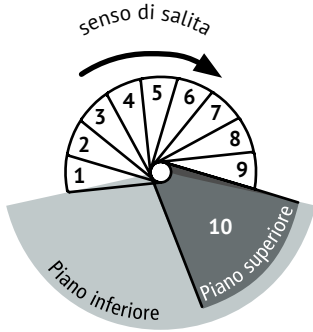

11 GRADINI pianerottolo incluso (11 ALZATE)
Altezza tra i piani: Min. 226 cm - Max. 264 cm

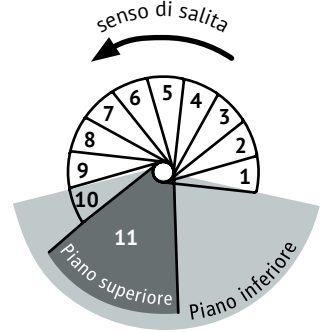
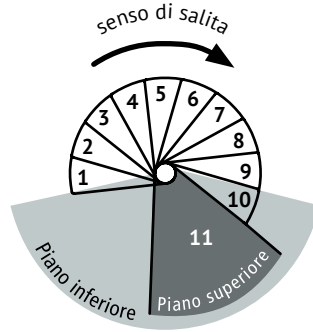

12 GRADINI pianerottolo incluso (12 ALZATE)
Altezza tra i piani: Min. 246 cm - Max. 288 cm

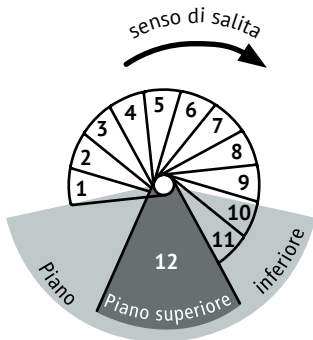

13 GRADINI pianerottolo incluso (13 ALZATE)
Altezza tra i piani: Min. 267 cm - Max. 312 cm

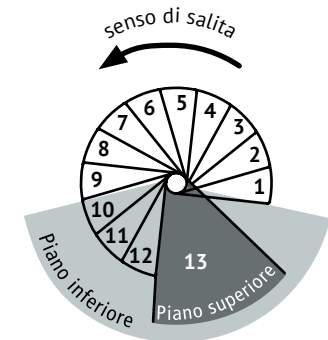
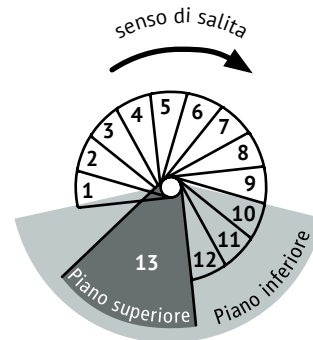

14 GRADINI pianerottolo incluso (14 ALZATE)
Altezza tra i piani: Min. 287 cm - Max. 336 cm

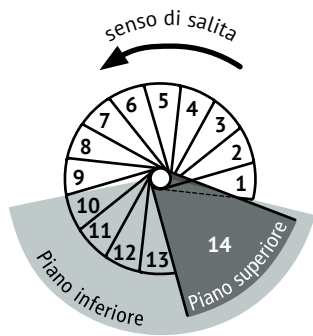
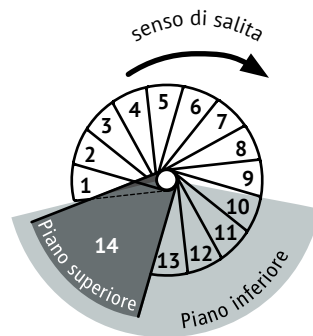

15 GRADINI pianerottolo incluso (15 ALZATE)
Altezza tra i piani: Min. 308 cm - Max. 360 cm

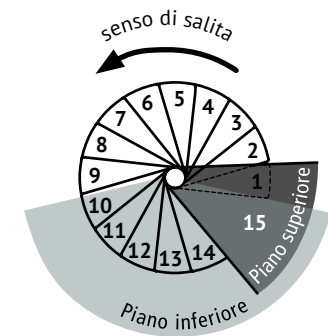
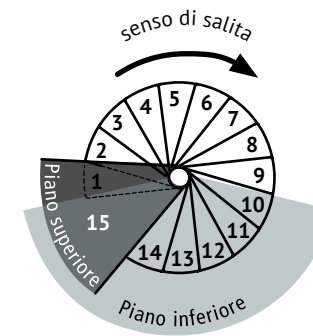

16 GRADINI pianerottolo incluso (16 ALZATE)
Altezza tra i piani: Min. 328 cm - Max. 384 cm

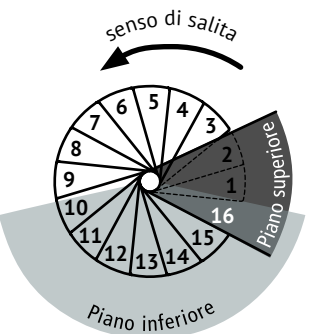
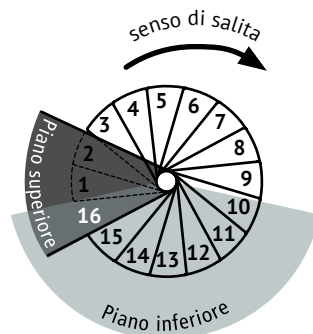

17 GRADINI pianerottolo incluso (17 ALZATE)
Altezza tra i piani: Min. 349 cm - Max. 408 cm

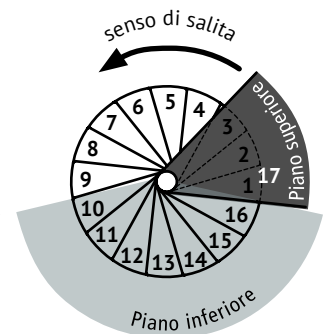
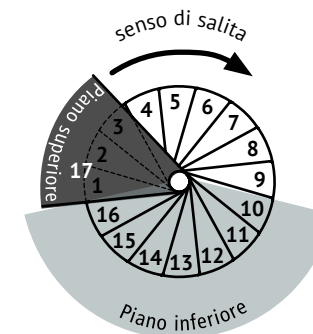

Per raggiungere altezze maggiori aggiungere gradini.

CONFIGURAZIONI HOOP (SENZA PIANEROTTOLO)

FORMA E DIMENSIONI MINIME DEL FORO SOLAIO

ARRIVO DIRETTO AL SOLAIO O SOPPALCO

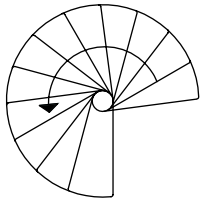

FORO A "L"

Dimensione foro: diametro scala + 5 cm

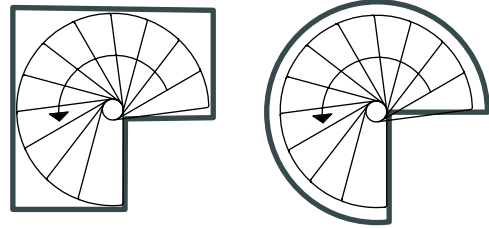

FORMA E MISURE DELLA SCALA

Diametro 118 cm

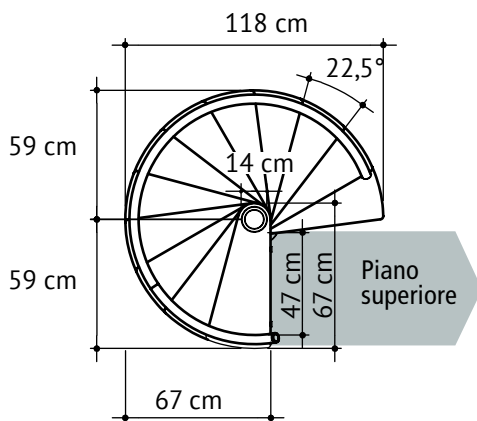

Diametro 138 cm

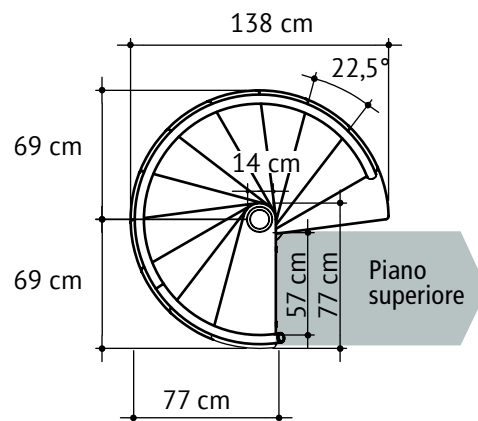

POSSIBILI CONFIGURAZIONI DELLA SCALA

Attraverso le seguenti configurazioni è possibile determinare il senso di salita, l'accesso alla scala dal piano inferiore e dal piano superiore in base al numero di gradini.

9 GRADINI (10 ALZATE)

Altezza tra i piani (cm): Min. 205 - Max 240

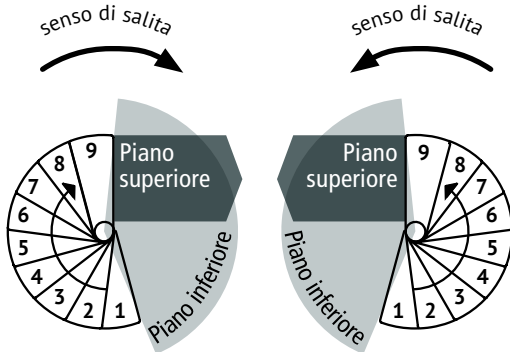

10 GRADINI (11 ALZATE)

Altezza tra i piani: Min. 226 cm - Max. 264 cm

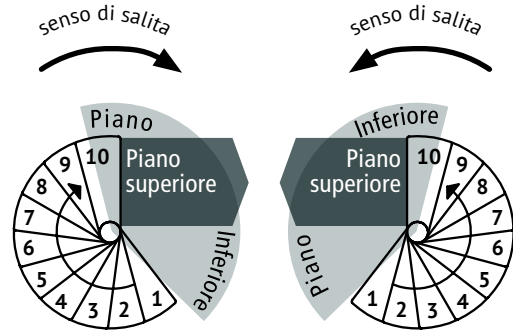

11 GRADINI (12 ALZATE)

Altezza tra i piani: Min. 246 cm - Max. 288 cm

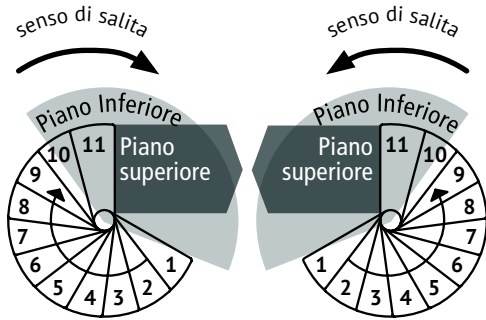

12 GRADINI (13 ALZATE)

Altezza tra i piani: Min. 267 cm - Max. 312 cm

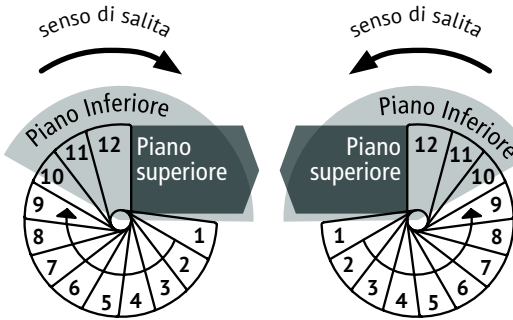

13 GRADINI (14 ALZATE)

Altezza tra i piani: Min. 287 cm - Max. 336 cm

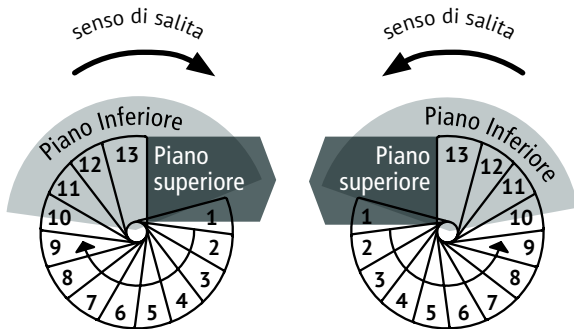

14 GRADINI (15 ALZATE)

Altezza tra i piani: Min. 308 cm - Max. 360 cm

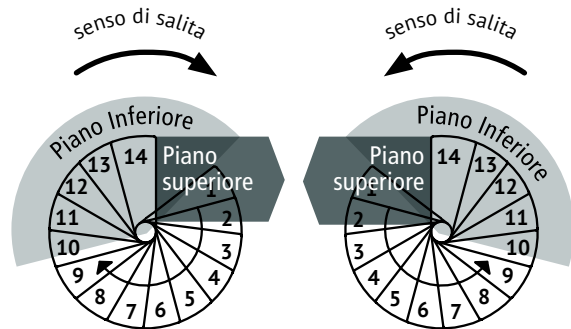

15 GRADINI (16 ALZATE)

Altezza tra i piani: Min. 328 cm - Max. 384 cm

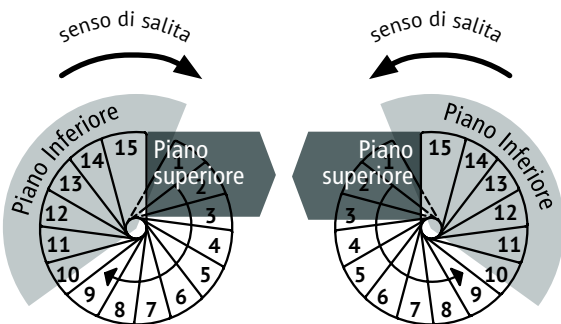

16 GRADINI (17 ALZATE)

Altezza tra i piani: Min. 349 cm - Max. 408 cm

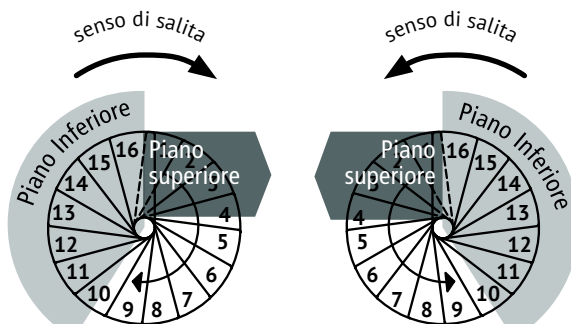

Per raggiungere altezze maggiori aggiungere gradini.