

**GARDEN  
HIGHPRO**



# **BORN**   
TO BE A  
**GROWER**

**GARDEN  
HIGHPRO** 

[WWW.GARDENHIGHPRO.COM](http://WWW.GARDENHIGHPRO.COM)    



# BORN  
TO BE A  
GROWER

# INDEX

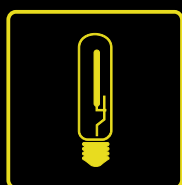

**LIGHTING**

**04**

---



**GROWTENTS**

**24**

---

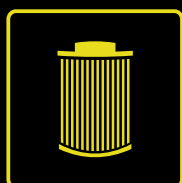

**FILTERS**

**40**

---



**VENTILATION**

**42**

---



**ACCESORIES**

**52**

---

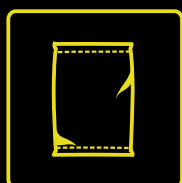

**SOIL**

**74**

---



**POTS**

**76**

---



**SEEDS**

**80**

---

# MAXLIGHT

HIGH PERFORMANCE REFLECTOR



PATENT PENDING



## AIR COOLED RECTANGULAR BASE REFLECTOR

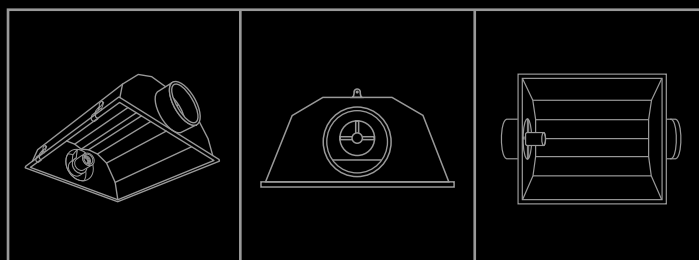
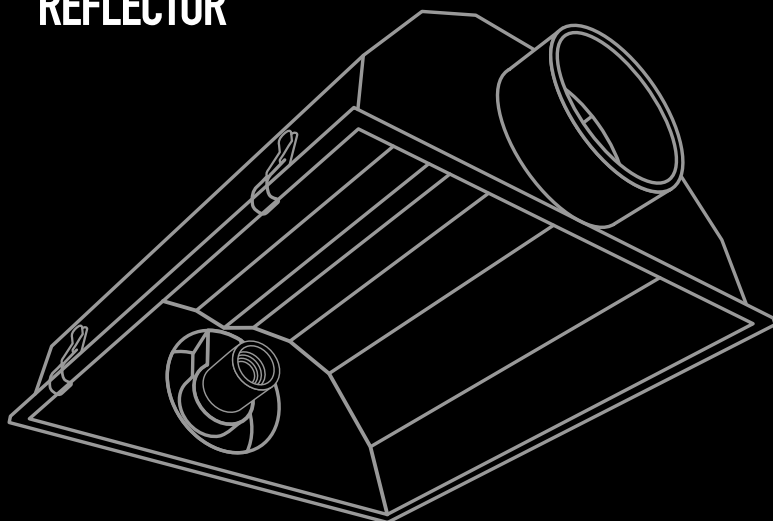

## MAXLIGHT

### Specifications

Length x width x height	60.5 x 48 x 21.5 cm
Diameter air in/extraction	∅ 15 cm
Aluminium	Pearl Technology marked aluminium
E40	250W - 600W HPS bulbs
Extra	Hinged Glass Secure wire connection case



# PROTUBE

HIGH PERFORMANCE REFLECTOR



PATENT PENDING

## AIR COOLED TUBULAR REFLECTOR

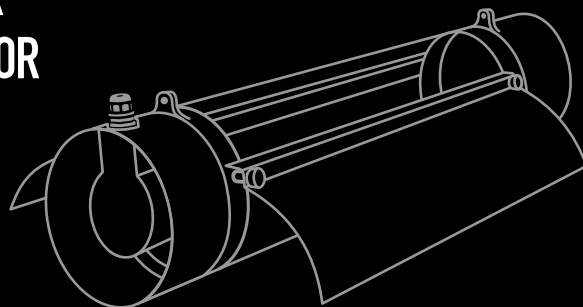

PROTUBE 125S	
PROTUBE 125M	
PROTUBE 125L	
PROTUBE 150L	
PROTUBE 150XL DOUBLE ENDED	

## PROTUBE

Specifications		
Diameter air in/extraction	PROTUBE 125 S/M/L	∅ 12.5 cm
	PROTUBE 150 L/XL	∅ 15 cm
Aluminium	Pearl Technology marked aluminium	
E40	250W - 600W HPS bulbs	
Extra	Plastic flanges for less heat build-up Secure wire connection case	



# INDOORMATRIX

LUMEN EVOLUTION





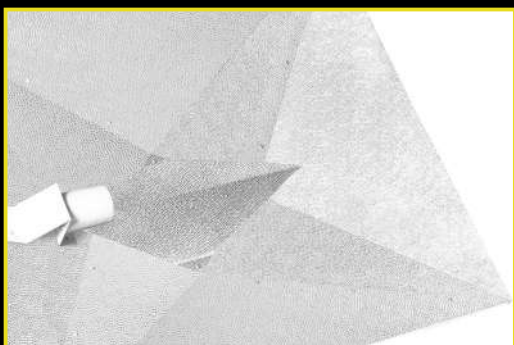

## SWISS DESIGN PYRAMIDAL REFLECTOR

Natural extraction of the heat

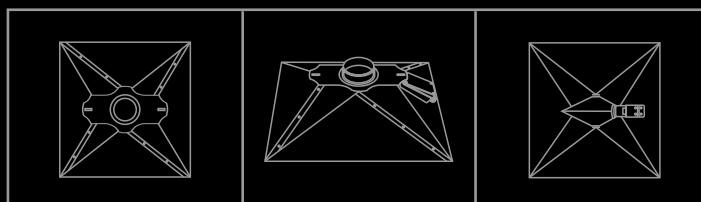
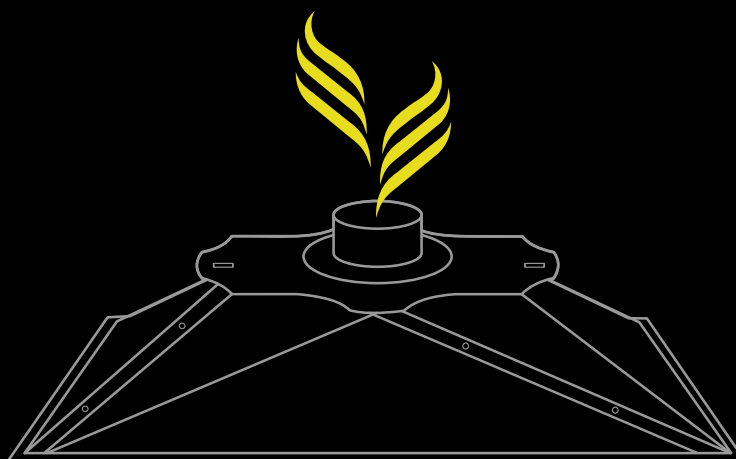

## INDOORMATRIX

### Specifications

Length x width x height	68 x 62 x 15 cm
Diameter air extraction	∅12.5 cm
Aluminium	Pearl Technology marked aluminium
E40	250W - 600W HPS bulbs
Extra	Flange for natural extraction of the heat Secure wire connection case



# PEARLPROXL

HIGH PERFORMANCE REFLECTOR



# LIGHTING

# PEARLPROXL+ HIGH PERFORMANCE REFLECTOR



## REGULABLE XL REFLECTOR

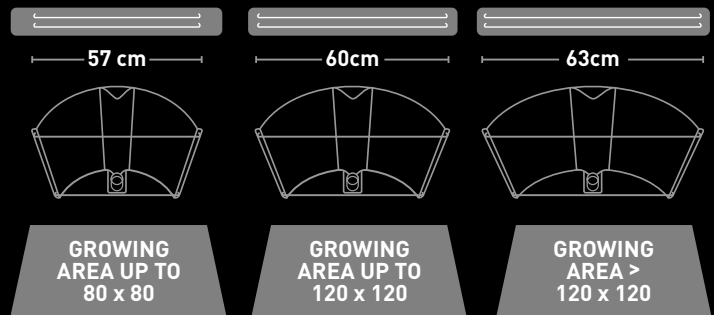
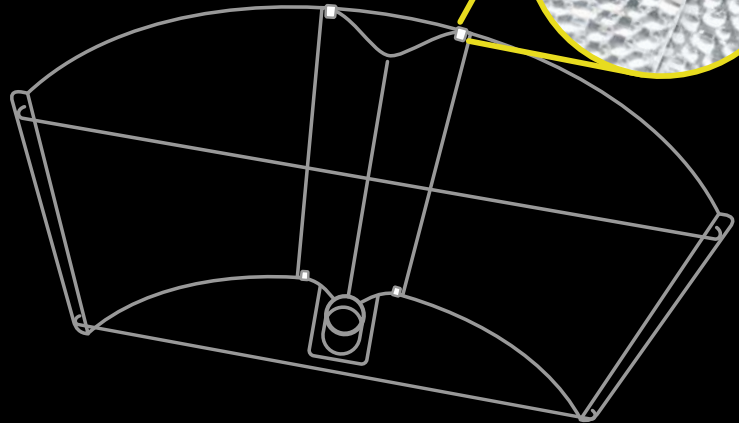
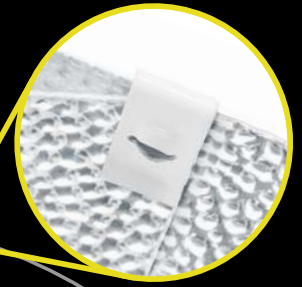

PEARLPRO XL is provided with 3 different sizes of spreader sticks allowing to maximize the light distribution depending on the size of the growing areas.

## PEARLPRO XL

Specifications	
Length x width	Option #1 55 x 57 cm Option #2 55 x 60 cm Option #3 55 x 63 cm
Aluminium	Pearl Technology marked aluminium
E40	250W - 600W HPS bulbs
Extra	Removable E40 spreader Secure wire connection case



# PEARLPRO+

HIGH PERFORMANCE REFLECTOR

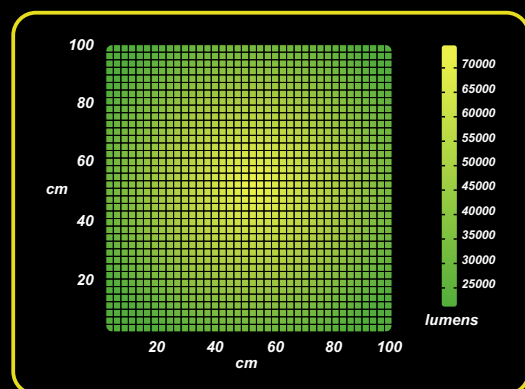
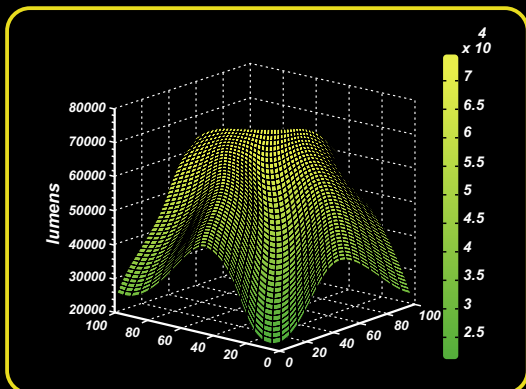



## PRIME STUCO REFLECTOR

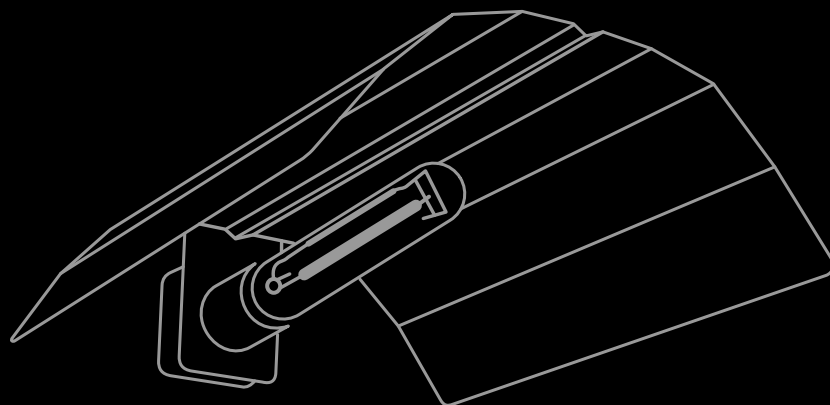

More luminous emittance (+5.1%) than a conventional Stuco. With the same power consumption it provides a higher light output over the area of interest. PEARLPRO simply has higher efficiency. The same power intake gets better outputs.

Significant better light distribution (+10%) than a conventional Stuco. It decreases the size of hotspots, and distributes light more homogeneously. Thanks to its greater light distribution and intensity, the PEARLPRO has better coverage. Consequently, crop uniformity will be also higher, providing and expected yield increase.

## PEARLPRO

### Specifications

Length x width x height	47 x 39 x 11 cm
Aluminium	Pearl Technology marked aluminium
E40	250W - 600W HPS bulbs
Extra	Secure wire connection case



# DOUBLEPRO

HIGH PERFORMANCE REFLECTOR



## DOUBLE ENDED REFLECTOR

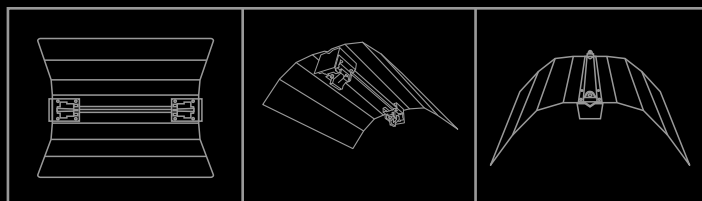
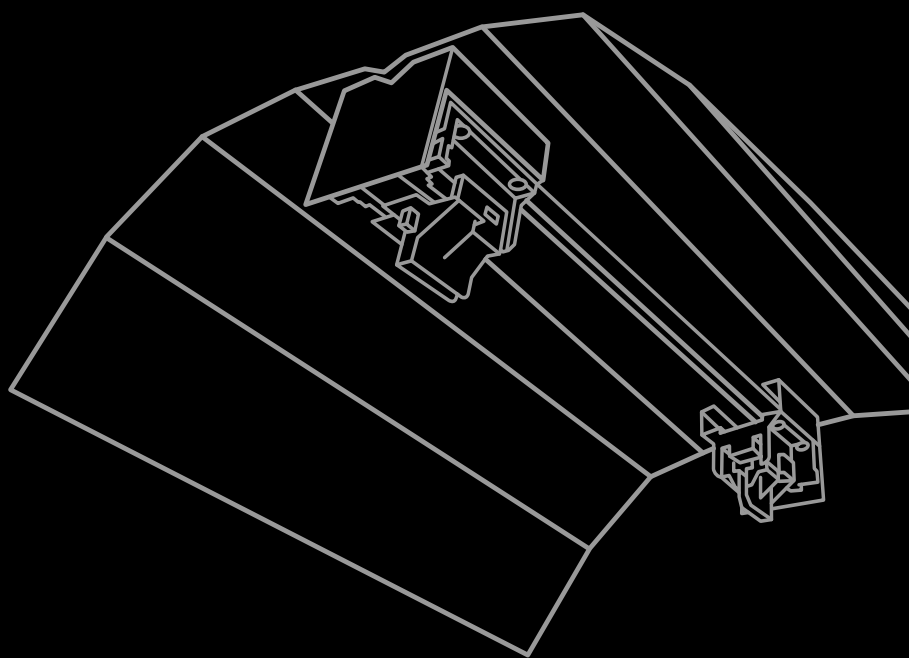
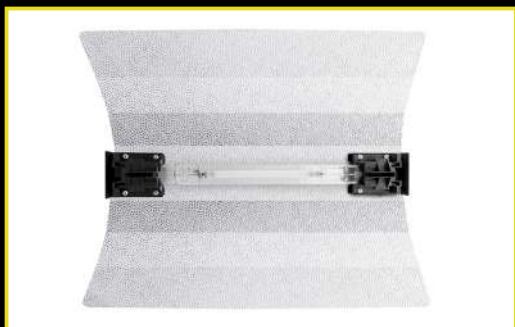

## DOUBLEPRO

### Specifications

Length x width x height	47 x 39 x 18 cm
Aluminium	Pearl Technology marked aluminium
Lamp holder	600W - 1000W double ended HPS bulbs
Extra	4m cable 3x1.5mm/IEC plug incl.



# LUMAXPRO+

PROFESSIONAL SODIUM LAMPS







## PROFESSIONAL MIXED SODIUM LAMPS

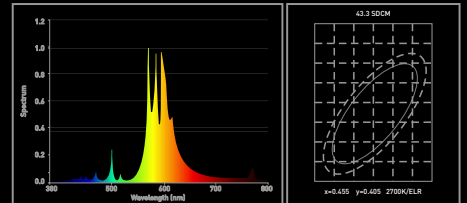

**250W**

**Color Parameters:** Chromaticity Coordinate:  $x=0.5341$   
 $y=0.4244/u'=0.3041$   $v'=0.5438$   $T_c=2008K$  Dominant  
 WL:Ld=587.8nm Purity=87.7% Centroid WL:595.0nm  
 Ratio:R=27.3% G=72.2% B=0.5% Peak WL:Lp=570.0nm  
 HWL:8.7nm Render Index: Ra= 19.5 **Photo Parameters:**  
 Flux: 33774 lm Fe:87.388 W Efficacy:126.2lm/W

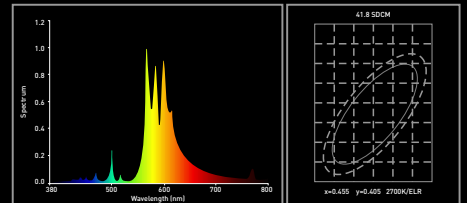

**400W**

**Color Parameters:** Chromaticity Coordinate:  $x=0.5326$   
 $y=0.4265/u'=0.3020$   $v'=0.5442$   $T_c=2033K$  Dominant  
 WL:Ld=587.5nm Purity=87.9% Centroid WL:597.0nm  
 Ratio:R=29.0% G=70.5% B=0.6% Peak WL:Lp=570.0nm  
 HWL:22.5nm Render Index: Ra= 25.4 **Photo Parameters:**  
 Flux: 55542 lm Fe:148.41 W Efficacy:134.9 lm/W

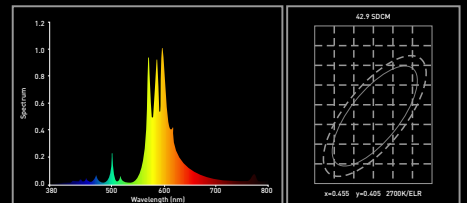

**600W**

**Color Parameters:** Chromaticity Coordinate:  $x=0.5349$   
 $y=0.4276/u'=0.3030$   $v'=0.5450$   $T_c=2020K$  Dominant  
 WL:Ld=587.5nm Purity=88.9% Centroid WL:594.0nm  
 Ratio:R=25.1% G= 74.4% B=0.5% Peak WL:Lp= 595.0nm  
 HWL: 15.7nm Render Index: Ra= 15.7 **Photo Parameters:**  
 Flux: 92811 lm Fe:233.53 W Efficacy:147.0 lm/W

## PROFESSIONAL MIXED SODIUM LAMPS

Power	Luminance	Efficiency	Colour T°	Rated Life
250W	32000/lm	128 LM/W	2000 K	32000 hours
400W	55000/lm	138 LM/W	2000 K	32000 hours
600W	90000/lm	150 LM/W	2000 K	32000 hours



# LUMAXPRO

ELECTROMAGNETIC BALLAST





## ELECTROMAGNETIC BALLAST

250W – 400W – 600W

Built-in thermal protection PTC and benefiting from an electronic start, LUMAXPRO Electromagnetic Ballasts ensure secure and fast connections guaranteeing lower electrical losses and higher light output. The well vented metal-case ensures the ballasts run cool and quiet. LUMAXPRO Electromagnetic Ballasts are supplied with a flying IEC lead which enables you to add any reflector fitted with a universal IEC socket.

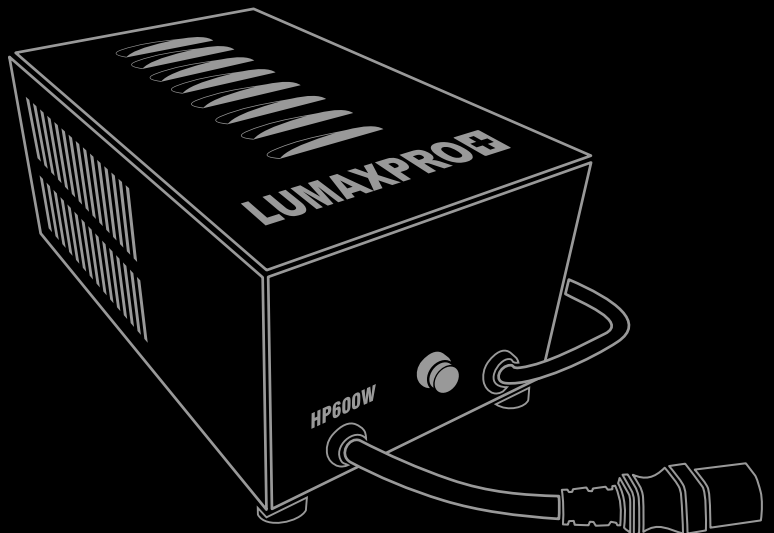

### ELECTROMAGNETIC BALLAST

Power	Lamp	Input
ELECTROMAGNETIC BALLAST 250W	250W HPS/MH	220-240V 50/60Hz I <sub>max</sub> 1.5A PF ≥ 0.95 THD ≤ 10% T <sub>a</sub> = -25-50°C T <sub>c</sub> = 70°C
ELECTROMAGNETIC BALLAST 400W	400W HPS/MH	220-240V 50/60Hz I <sub>max</sub> 2.2A PF ≥ 0.95 THD ≤ 10% T <sub>a</sub> = -25-50°C T <sub>c</sub> = 70°C
ELECTROMAGNETIC BALLAST 600W	600W HPS/MH	220-240V 50/60Hz I <sub>max</sub> 3.1A PF ≥ 0.92 THD ≤ 10% T <sub>a</sub> = -25-50°C T <sub>c</sub> = 70°C



# LUMAXPRO

DIMMABLE DIGITAL BALLAST





## DIMMABLE DIGITAL BALLAST 400W - 600W

LUMAXPRO dimmable digital ballasts are the most advanced lighting solution for modern horticulture. Small, compact, and completely silent these E-Ballasts are able to provide a precise controlled output voltage to the lamp ensuring optimum PAR levels are achieved.

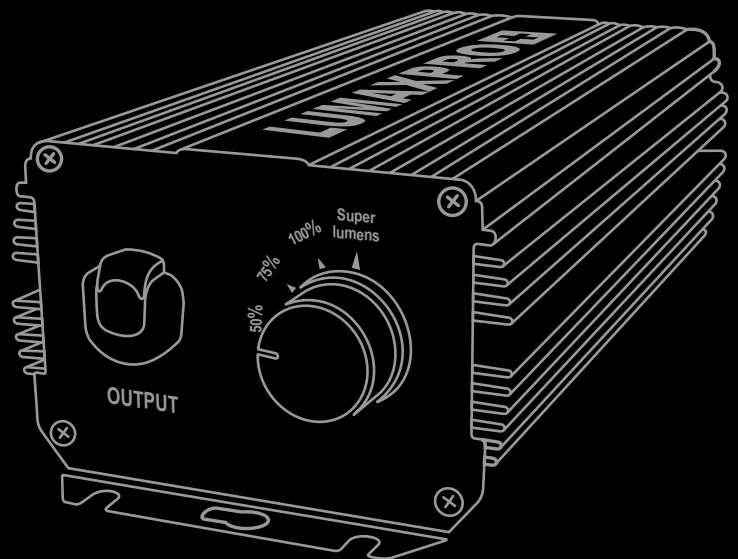

### DIMMABLE DIGITAL BALLAST

Power	Lamp	Input	Output Frequency
<b>ELECTRONIC BALLAST 400W</b>	400W HPS/MH	220-240V, 50/60Hz I <sub>max</sub> =2.0A, CF ≤ 1.6, PF > 0.98 O.C.V.=250V, THD ≤ 8% T <sub>a</sub> =40°C/104°F, T <sub>c</sub> = 70°C/158°F	90KHz
<b>ELECTRONIC BALLAST 600W</b>	600W HPS/MH	220-240V, 50/60Hz I <sub>max</sub> =3.0A, CF ≤ 1.6, PF > 0.98 O.C.V.=250V, THD ≤ 8% T <sub>a</sub> =40°C/104°F, T <sub>c</sub> = 70°C/158°F	90KHz



# TEMPRO

DIGITAL & ANALOGUE TIMER

**LED Display**  
Green LED Display  
for not stressing  
the plants



# LIGHTING

# TEMPRO+ DIGITAL & ANALOGUE TIMER



## ANALOGUE TIMER

24-hour daily scheduler  
Setting time 30min.

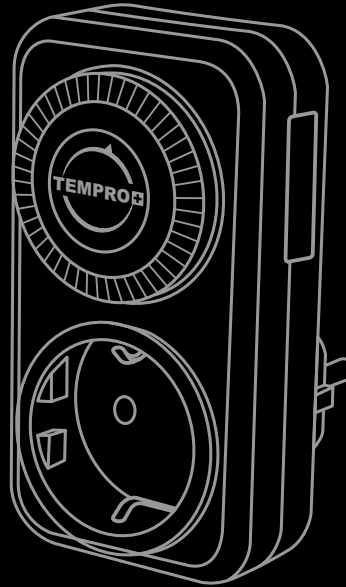

UK 13A / max 2.990W	US 16A / max 3.680W
FR/CZ 16A / max 3.680W	EU 16A / max 3.680W
CL/IT 10A / max 2.500W	AR 16A / max 3.680W

## DIGITAL TIMER

24-hour daily scheduler  
Setting time: 1minute



UK 13A / max 3.120W	US 15A / max 1.800W
FR/CZ 13A / max 3.120W	EU 16A / max 3.680W
CL/IT 10A / max 2.200W	AR 15A / max 1.800W



# PROBOX

GROWTENT ECOPRO VERSION







## PROBOX ECOPRO VERSION

Strong and resistant fabric Nylon 420D  
Patented, strong and stable structure  
Premium mylar reflectivity 97%



PROBOX ECOPRO	Size (LxWxH)	Capacity kg	Side Doors	Windows Air Inlet	Round Extraction Socks	Electrical Cable Socks
PROBOX ECOPRO 40	40x40x140cm	23kg	0 units	1 unit	2 units	0 units
PROBOX ECOPRO 60	60x60x140cm	23kg	0 units	1 unit	2 units	0 units
PROBOX ECOPRO 80	80x80x160cm	23kg	0 units	1 unit	2 units	0 units
PROBOX ECOPRO 100	100x100x200cm	23kg	0 units	1 unit	2 units	0 units
PROBOX ECOPRO 120	120x120x200cm	23kg	0 units	1 unit	2 units	0 units
PROBOX ECOPRO 150	150x150x200cm	23kg	0 units	1 unit	2 units	0 units
PROBOX ECOPRO 240L	240x120x200cm	28kg	0 units	1 unit	3 units	1 unit

# PROBOX

## GROWTENT BASIC VERSION





## PROBOX BASIC VERSION

- Strong and resistant fabric Nylon 420D
- Patented, strong and stable structure
- Premium mylar reflectivity 97%
- Resistant and lightproof zippers
- Doubled and soft fabric sockets



PROBOX BASIC	Size (LxWxH)	Capacity kg	Side Doors	Windows Air Inlet	Round Extraction Socks	Electrical Cable Socks
PROBOX BASIC 40	40x40x160cm	28kg	0 units	1 units	5 units	1 units
PROBOX BASIC 60	60x60x160cm	28kg	0 units	1 units	5 units	1 units
PROBOX BASIC 80	80x80x160cm	28kg	0 units	1 units	5 units	1 units
PROBOX BASIC 100	100x100x200cm	28kg	0 units	1 units	5 units	1 units
PROBOX BASIC 120	120x120x200cm	28kg	0 units	1 units	5 units	1 units
PROBOX BASIC 150	150x150x200cm	28kg	0 units	1 units	5 units	1 units
PROBOX BASIC 240L	240x120x200cm	36kg	0 units	2 units	8 units	2 units
PROBOX BASIC 240	240x240x200cm	52kg	2 units	2 units	10 units	2 units

# PROBOX

## GROWTENT MASTER VERSION



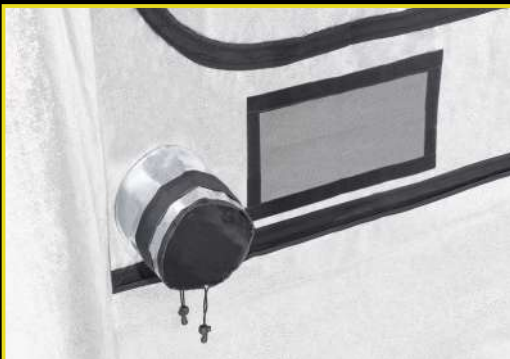

## PROBOX MASTER VERSION

- Strong and resistant fabric Nylon 600D
- Jumbo side windows for easy access
- Patented, strong and stable structure
- Doubled and strong extraction socks
- Premium mylar reflectivity 97%
- Certified mylar plants friendly
- Resistant and lightproof zippers
- Air entrance windows

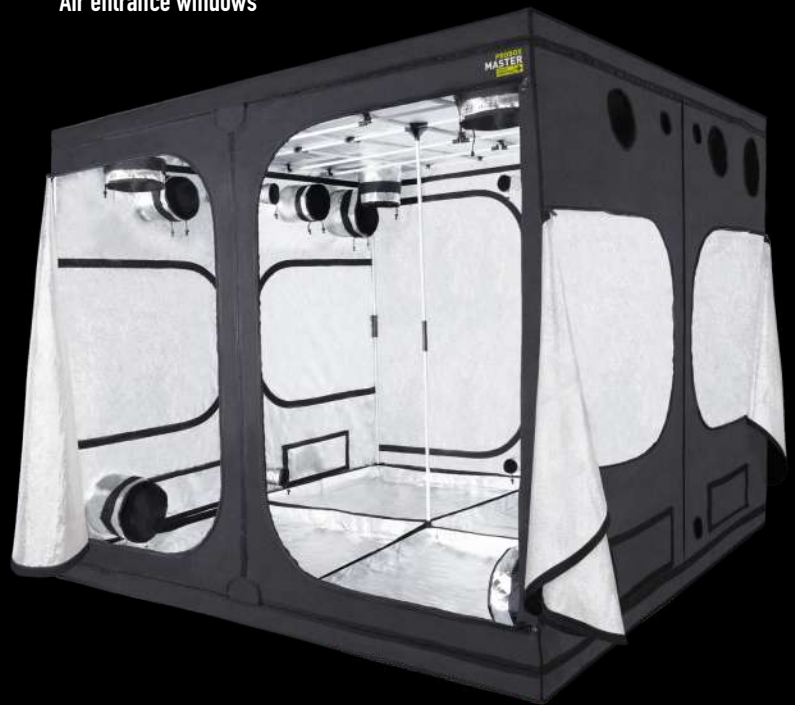

PROBOX MASTER	Size (LxWxH)	Capacity kg	Side Doors	Windows Air Inlet	Round Extraction Socks	Electrical Cable Socks
PROBOX MASTER 80	80x80x160cm	36kg	2 ud	3 ud	5 ud	3 ud
PROBOX MASTER 100	100x100x200cm	36kg	2 ud	3 ud	5 ud	3 ud
PROBOX MASTER 120	120x120x200cm	36kg	2 ud	3 ud	5 ud	3 ud
PROBOX MASTER 150	150x150x200cm	36kg	2 ud	3 ud	5 ud	3 ud
PROBOX MASTER 200	200x200x200cm	72kg	4 ud	4 ud	10 ud	6 ud
PROBOX MASTER 240L	240x120x200cm	54kg	2 ud	2 ud	8 ud	4 ud
PROBOX MASTER 240	240x240x200cm	72kg	4 ud	4 ud	10 ud	6 ud
PROBOX MASTER 300L	300x150x200cm	54kg	2 ud	2 ud	8 ud	4 ud

# PROBOX

GROWTENT MAGNUM VERSION



Pearl  
Technology  
Quality  
Aluminium



**220**  
cm  
HIGH



## PROBOX MAGNUM

- Strong and resistant fabric Nylon 600D
- Patented, strong and stable structure
- Premium and certified mylar reflectivity 97%
- Resistant and lightproof zippers
- Doubled and soft fabric sockets

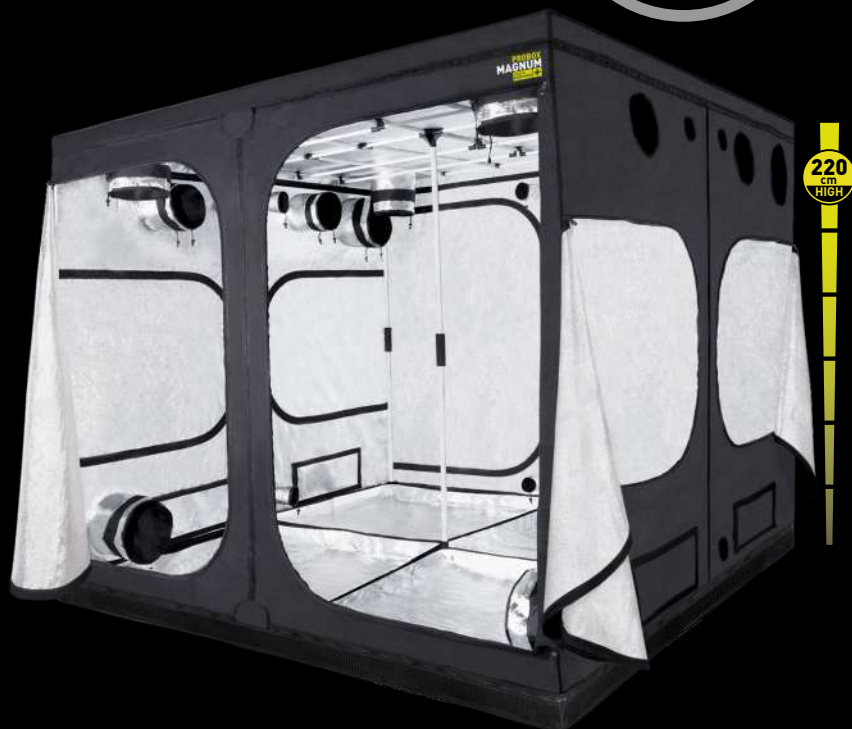
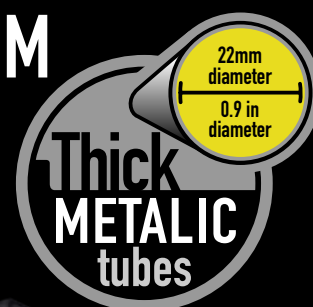

PROBOX MAGNUM	Size (LxWxH)	Capacity kg	Side Doors	Windows Air Inlet	Round Extraction Socks	Electrical Cable Socks
PROBOX MAGNUM 80	80x80x180cm	54kg	2 ud	3 ud	5 ud	3 ud
PROBOX MAGNUM 100	100x100x220cm	54kg	2 ud	3 ud	5 ud	3 ud
PROBOX MAGNUM 120	120x120x220cm	54kg	2 ud	3 ud	5 ud	3 ud
PROBOX MAGNUM 150	150x150x220cm	54kg	2 ud	3 ud	5 ud	3 ud
PROBOX MAGNUM 240L	240x120x220cm	79kg	2 ud	2 ud	8 ud	4 ud
PROBOX MAGNUM 240	240x240x220cm	99kg	4 ud	4 ud	10 ud	6 ud
PROBOX MAGNUM 300L	300x150x220cm	79kg	2 ud	2 ud	8 ud	4 ud
PROBOX MAGNUM 300XL	300x200x220cm	99kg	4 ud	4 ud	10 ud	6 ud
PROBOX MAGNUM 300XXL	300x300x220cm	99kg	4 ud	4 ud	10 ud	6 ud

# PROBOX

## GROWTENT BUNKER VERSION







## PROBOX BUNKER

- Strong and resistant fabric Nylon 1600D
- Patented, strong and stable structure
- Premium and certified mylar reflectivity 97%
- Resistant and lightproof zippers
- Doubled and soft fabric sockets

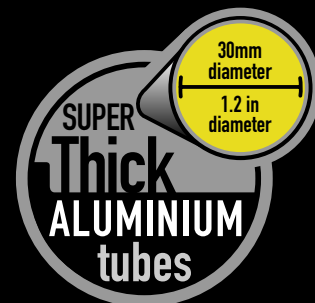

240  
cm  
HIGH



PROBOX BUNKER	Size (LxWxH)	Capacity kg	Side Doors	Windows Air Inlet	Round Extraction Socks	Electrical Cable Socks
PROBOX BUNKER 240	240x240x240cm	129kg	4 ud	4 ud	10 ud	6 ud
PROBOX BUNKER 300L	300x150x240cm	129kg	2 ud	2 ud	8 ud	4 ud
PROBOX BUNKER 300XL	300x200x240cm	119kg	4 ud	4 ud	10 ud	6 ud
PROBOX BUNKER 300XXL	300x300x240cm	129kg	4 ud	4 ud	10 ud	6 ud

# PROBOX

GROWTENT PL VERSION

  
Pearl  
Technology  
Quality  
Aluminium



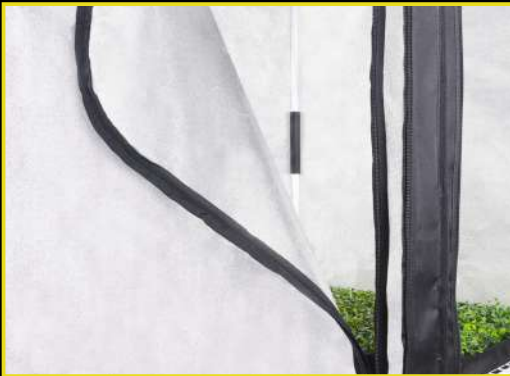

## PROBOX PL

- Strong and resistant fabric Nylon 600D
- Patented, strong and stable structure
- Premium and certified mylar reflectivity 97%
- Resistant and lightproof zippers
- Doubled and soft fabric sockets

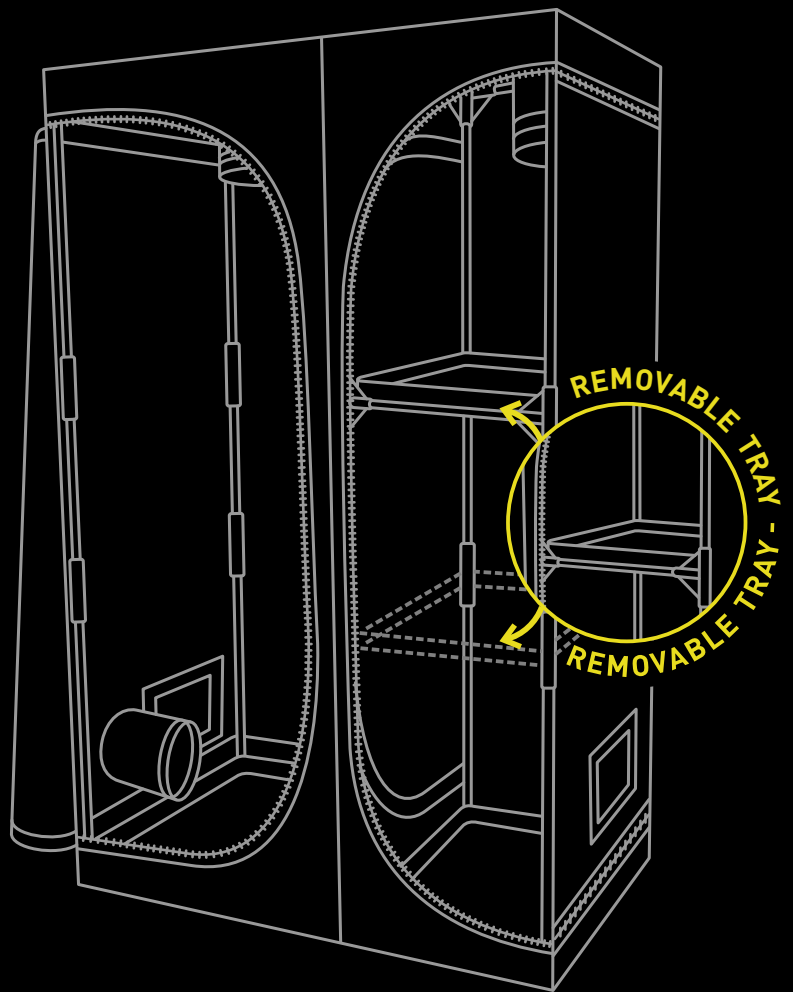

PROBOX PL	Size (LxWxH)	Capacity kg	Front Doors	Windows Air Inlet	Round Extraction Socks	Electrical Cable Socks
PROBOX PL	100 x 60 x 160 cm	36kg	2 ud	2 ud	3 ud	2 ud

# PROPAGATOR

PROFESSIONAL PROPAGATION SYSTEM



# GROWTENTS

# PROPAGATOR+

PROFESSIONAL PROPAGATION SYSTEM

## XL Size

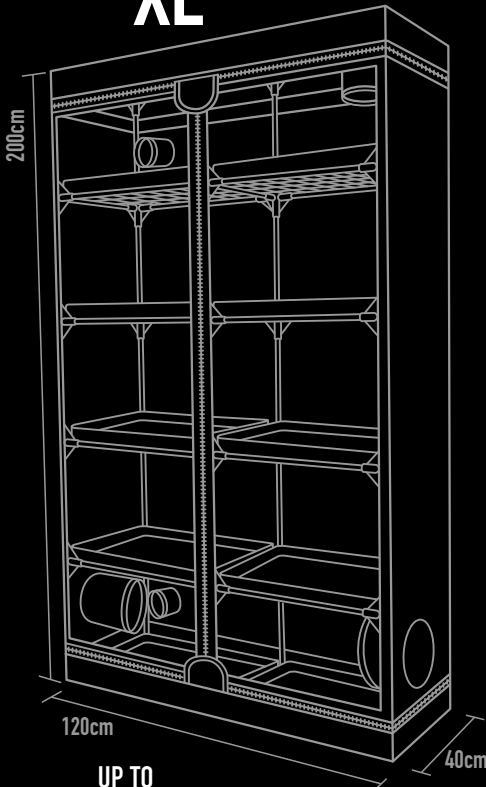

UP TO  
**1.440 CUTTINGS\***

* 10 TRAYS OF 144 UNITS <b>1.440 UNITS</b>	10 TRAYS OF 104 UNITS <b>1.040 UNITS</b>
10 TRAYS OF 84 UNITS <b>840 UNITS</b>	10 TRAYS OF 60 UNITS <b>600 UNITS</b>



### Specifications

Front Door	2 units	55 x 190 cm
Windows Air Inlet	2 units	30 x 20 cm
Round Extraction Socks	3 units	∅ 13,5 cm
Electrical Cable Socks	4 units	∅ 8 cm

## L Size

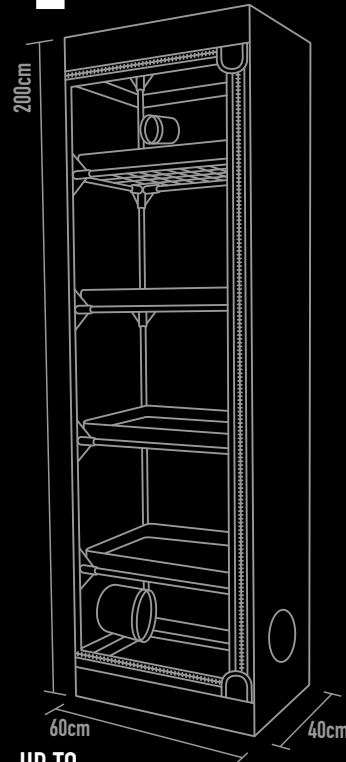

UP TO  
**720 CUTTINGS\***

* 5 TRAYS OF 144 UNITS <b>720 UNITS</b>	5 TRAYS OF 104 UNITS <b>520 UNITS</b>
5 TRAYS OF 84 UNITS <b>420 UNITS</b>	5 TRAYS OF 60 UNITS <b>300 UNITS</b>



### Specifications

Front Door	1 units	55 x 190 cm
Windows Air Inlet	1 units	30 x 20 cm
Round Extraction Socks	3 units	∅ 13,5 cm
Electrical Cable Socks	2 units	∅ 8 cm

## M Size

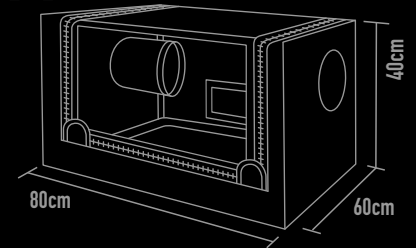

UP TO  
**208 CUTTINGS\***

* 2 TRAYS OF 144 UNITS <b>288 UNITS</b>	2 TRAYS OF 104 UNITS <b>208 UNITS</b>
2 TRAYS OF 84 UNITS <b>168 UNITS</b>	2 TRAYS OF 60 UNITS <b>120 UNITS</b>

### Specifications

Front Door	1 units	75 x 30 cm
Windows Air Inlet	1 units	50 x 15 cm
Round Extraction Socks	2 units	∅ 13,5 cm
Electrical Cable Socks	1 units	∅ 8 cm

## S Size

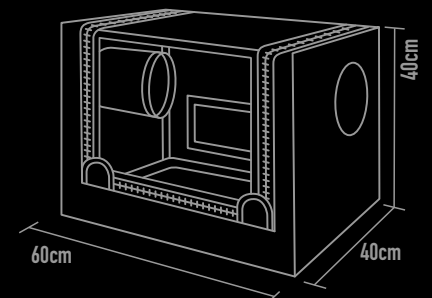

UP TO  
**104 CUTTINGS\***

* 1 TRAY OF 144 UNITS <b>144 UNITS</b>	1 TRAY OF 104 UNITS <b>104 UNITS</b>
1 TRAY OF 84 UNITS <b>84 UNITS</b>	1 TRAY OF 60 UNITS <b>60 UNITS</b>

### Specifications

Front Door	1 units	55 x 30 cm
Windows Air Inlet	1 units	50 x 15 cm
Round Extraction Socks	2 units	∅ 13,5 cm
Electrical Cable Socks	1 units	∅ 8 cm

# LEDMAXPRO+

PROPAGATION LIGHTING SYSTEM

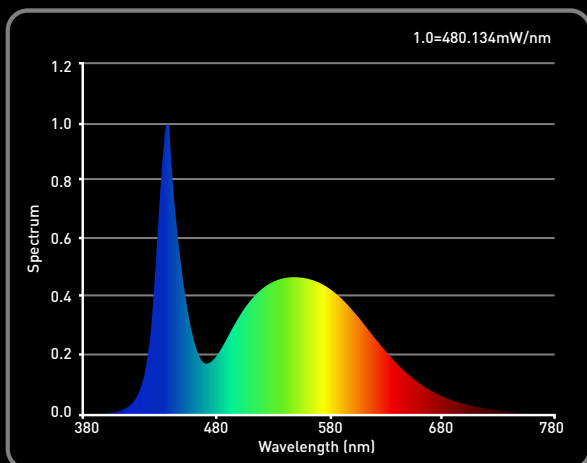
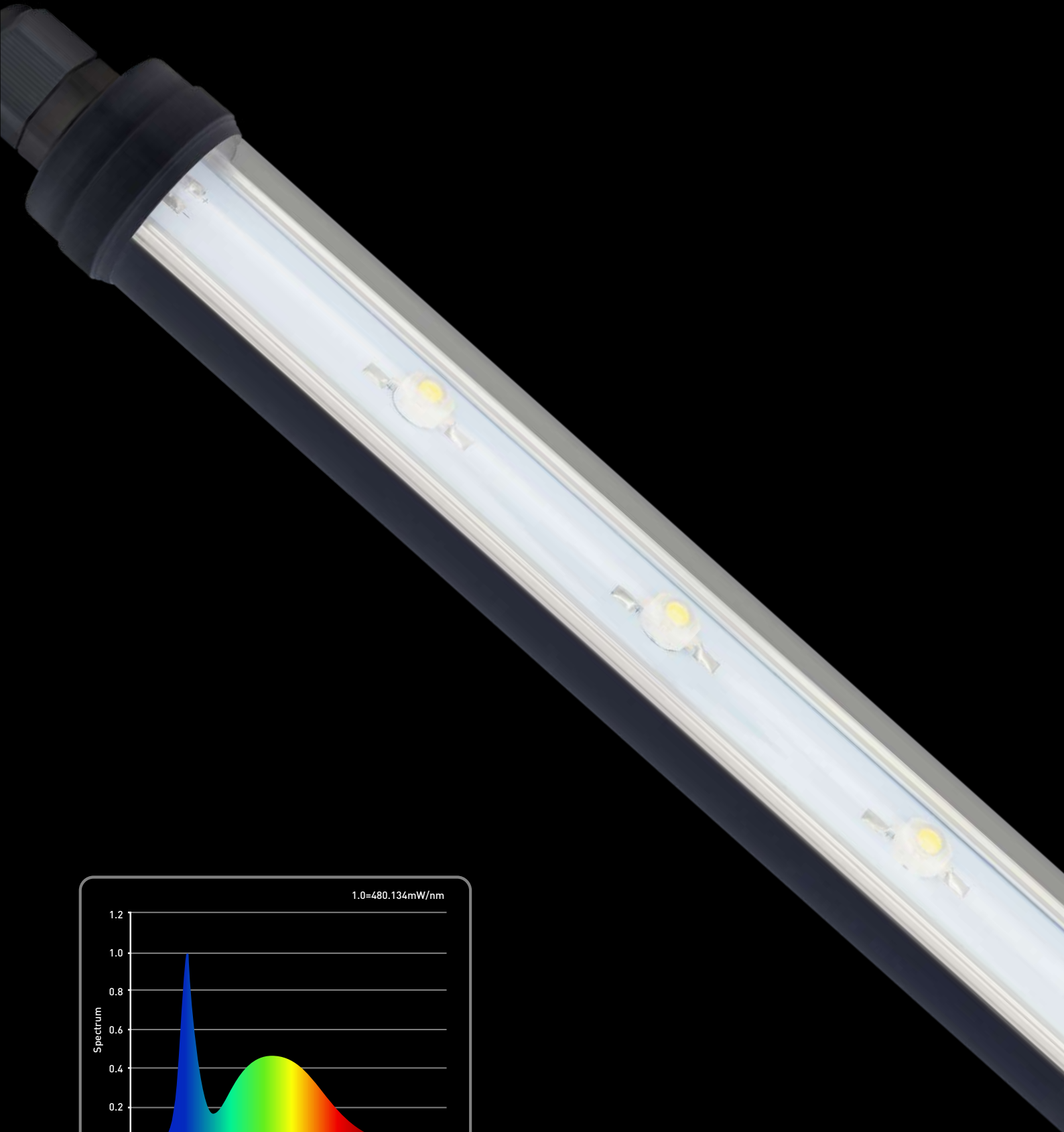

# LIGHTING

# LEDMAXPRO+

PROPAGATION LIGHTING SYSTEM

## PROPAGATION LIGHTING SYSTEM

Exclusive use for cuttings

No excess heat generated for the plants

100% humidity proof

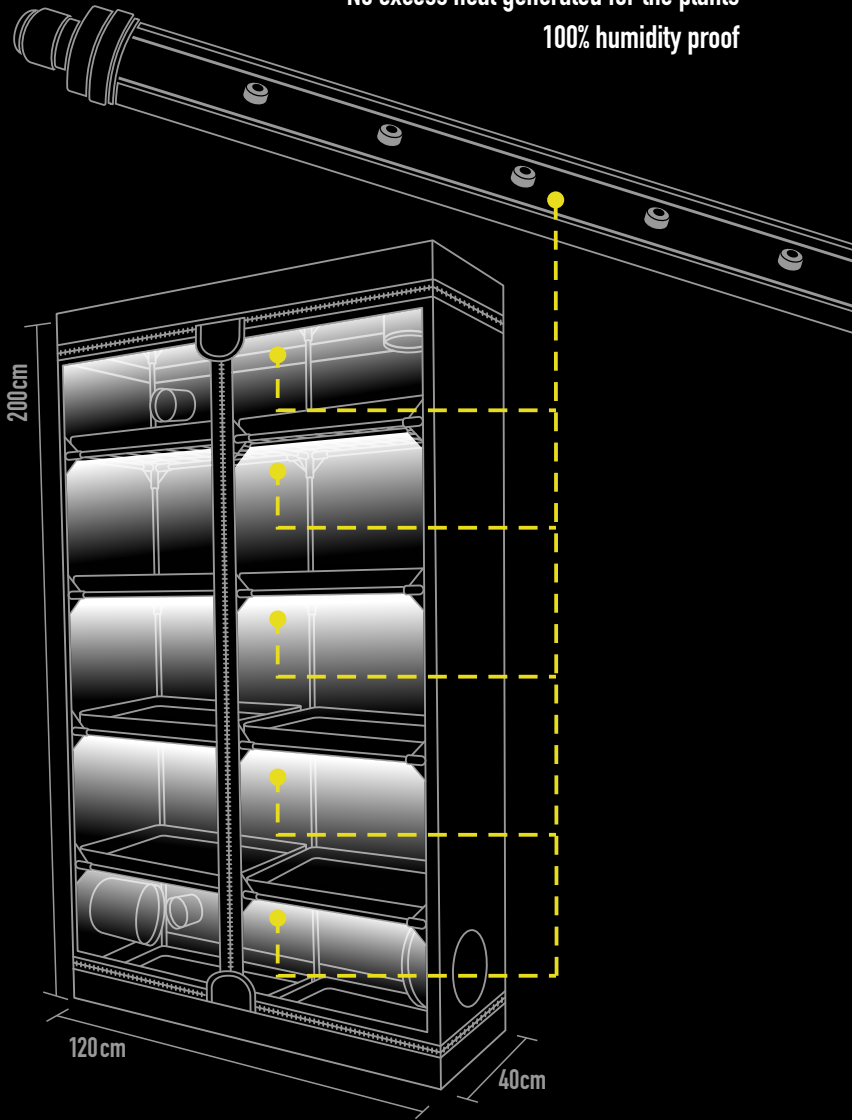

## PROPAGATION LIGHTING SYSTEM

Size	Power	Voltage	Frecuency	Durability
S - 55cm	1x 10W	110-240V	50 - 60 Hz	20.000 hours
M - 55cm	2x 10W	110-240V	50 - 60 Hz	20.000 hours
L - 55cm	5x 10W	110-240V	50 - 60 Hz	20.000 hours
XL - 110cm	5x 20W	110-240V	50 - 60 Hz	20.000 hours



# PROACTIV

ACTIVATED CARBON FILTER





# FILTERS

# PROACTIV+

ACTIVATED CARBON FILTER



100%



food grade virgin  
**coconut**  
activated carbon

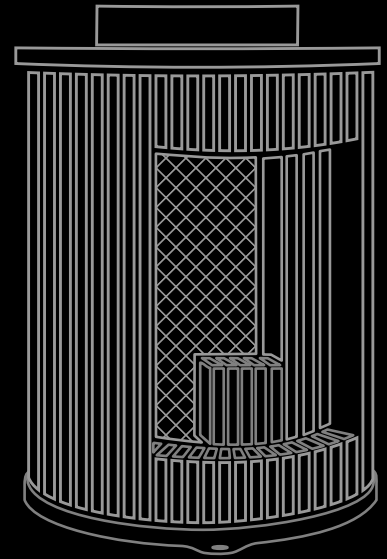

PROACTIV activated carbon filters are extremely reliable to remove any undesirable odours in the air. They are lighter, smaller, more efficient and safer than conventional carbon filters alternatives. PROACTIV filters use only food grade virgin coconuts activated carbon which is considered the best carbon to remove organic smell. The multilayer fleece mats are sealed air-tight in the base and cover, preventing any accidental intake of (unfiltered) air. The innovative design of the flange and the base of PROACTIV filters simplify their use. They can be hanged directly from their extremity without having to surround the filter with chains or girths.

## PROACTIV

Diameter	m3/h	Length
∅ 100 mm	250 m3/h	190 mm
∅ 125 mm	250 m3/h	190 mm
∅ 125 mm	460 m3/h	300 mm
∅ 125 mm	600 m3/h	450 mm
∅ 150 mm	460 m3/h	300 mm
∅ 150 mm	690 m3/h	450 mm
∅ 150 mm	840 m3/h	550 mm
∅ 200 mm	800 m3/h	450 mm
∅ 200 mm	1.000 m3/h	550 mm

# PROFAN

STANDARD CLIP FAN





## STANDARD CLIPFAN

### 15cm - 15W

15W AC engine  
 2 speeds + stop  
 100% copper engine for longer life  
 Strong clip for more stability

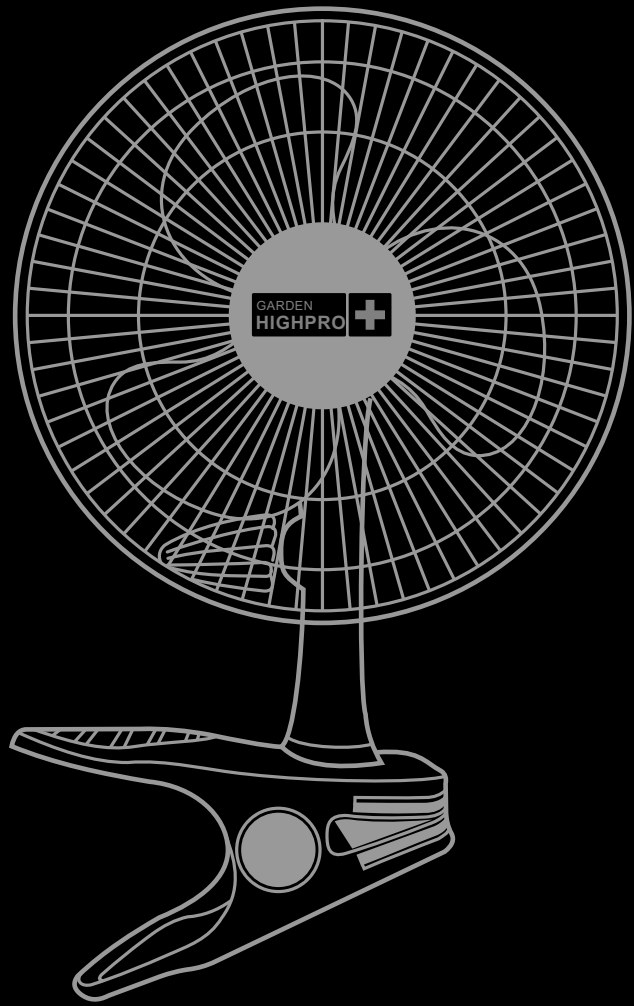

## STANDARD CLIPFAN

Diameter	Power	Speed	Air Flow
15 cm	15W	2.100 T/min	200 m3/h

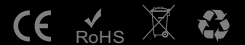

# PROFAN

PROFESSIONAL CLIP FAN



Direct  
**Drive**  
Magnetic  
Engine

GARDEN  
HIGHPRO 

# VENTILATION

# PROFAN

PROFESSIONAL CLIP FAN

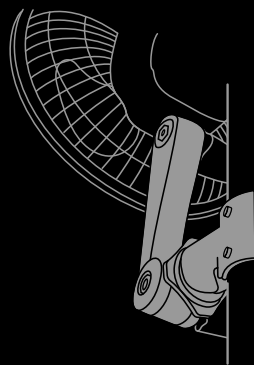
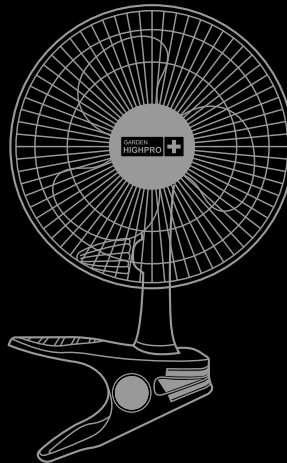

## PREMIUM CLIPFAN 15cm – 5W

Direct drive magnetic engine  
1 speed + stop  
Extremely silent  
Lighter and more stable

Diameter	Power	Speed	Air Flow
∅ 15 cm	5W	2.100 T/min	215 m3/h

### Additional Patented Fixing System

Adaptable to tubes up to 3cm diameter

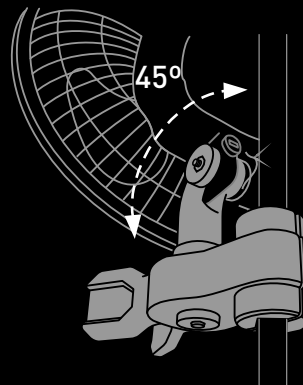
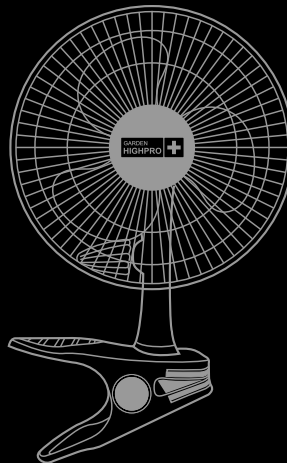

## PREMIUM CLIPFAN 20cm – 12W

Direct drive magnetic engine  
1 speed + stop  
Extremely silent  
Lighter and more stable

Diameter	Power	Speed	Air Flow
∅ 20 cm	12W	1.800 T/min	325 m3/h

### Additional Fixing System

Adaptable to tubes up to 3cm diameter

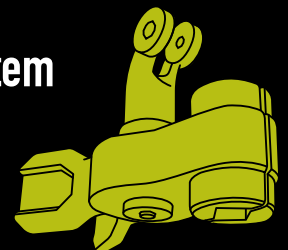

# PROFAN

PROFESSIONAL OSCILLATING CLIP FAN





## OSCILLATING CLIP FAN

20W AC engine  
2 speeds + stop  
100% copper engine  
Strong clip

360° rotating grid for greater air distribution

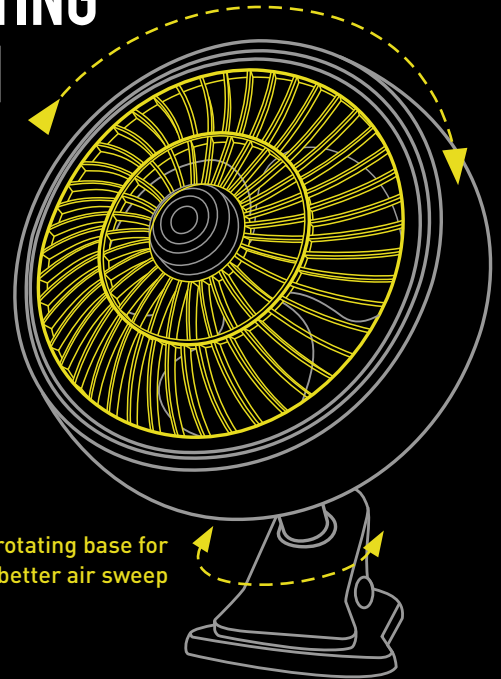

90° rotating base for better air sweep

## Additional Fixing System

Adaptable to tubes up to 3cm diameter

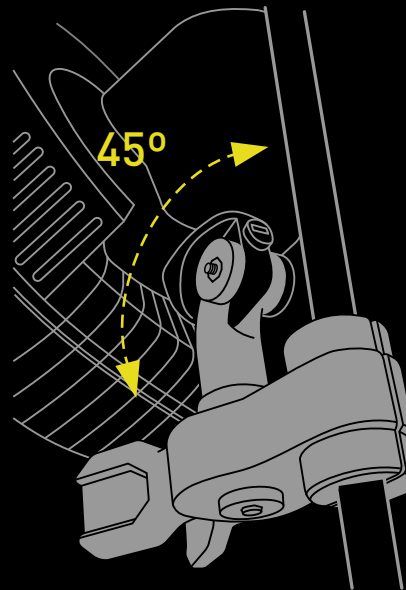

## PROFESSIONAL OSCILLATING CLIP FAN

Diameter	Power	Speed	Air Flow
∅ 25 cm	20W	2.100 T/min	305 m3/h



# PROFAN

TT EXTRACTOR FAN



**2 Speeds**  
**MaxPower**





Cable Included +  
2 speeds



High  
Performance  
Guaranteed



3 Sizes  
available

150

125

100

## AXIAL TT EXTRACTOR FAN

Super Power

2 speeds + stop

100% copper engine

Cable included

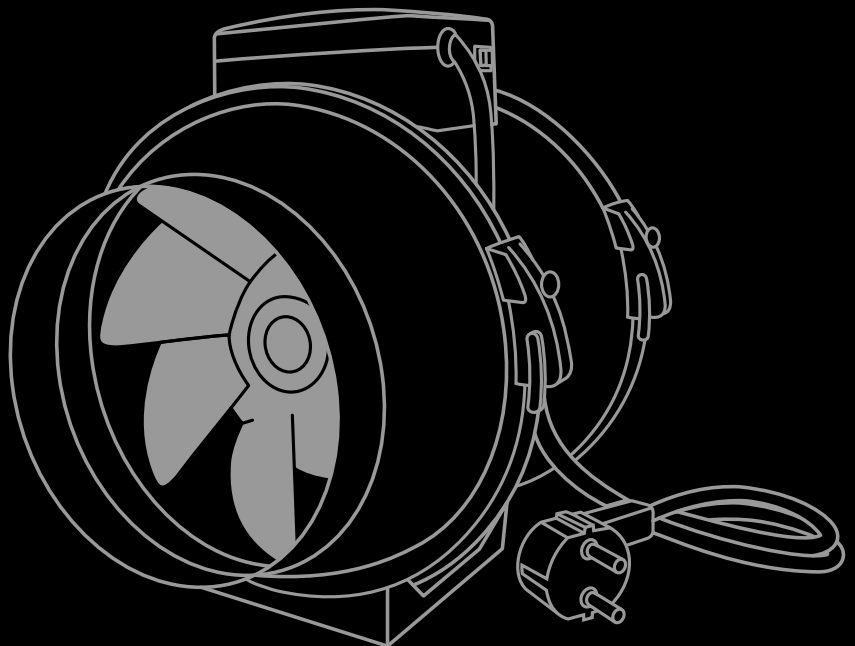

### TT EXTRACTOR FAN

Diameter	Power	Speed	Air Flow
TTMAX 100	21W	2.180 r/min	145 m3/h
∅ 100 mm	33W	2.385 r/min	187 m3/h
TTMAX 125	23W	1.950 r/min	220 m3/h
∅ 125 mm	37W	2.455 r/min	280 m3/h
TTMAX 150	30W	1.680 r/min	405 m3/h
∅ 150 mm	60W	2.460 r/min	520 m3/h



# PROFAN

AXIAL INLINE FAN



*MaxPower*



## AXIAL INLINE FAN

Super Power  
100% copper engine

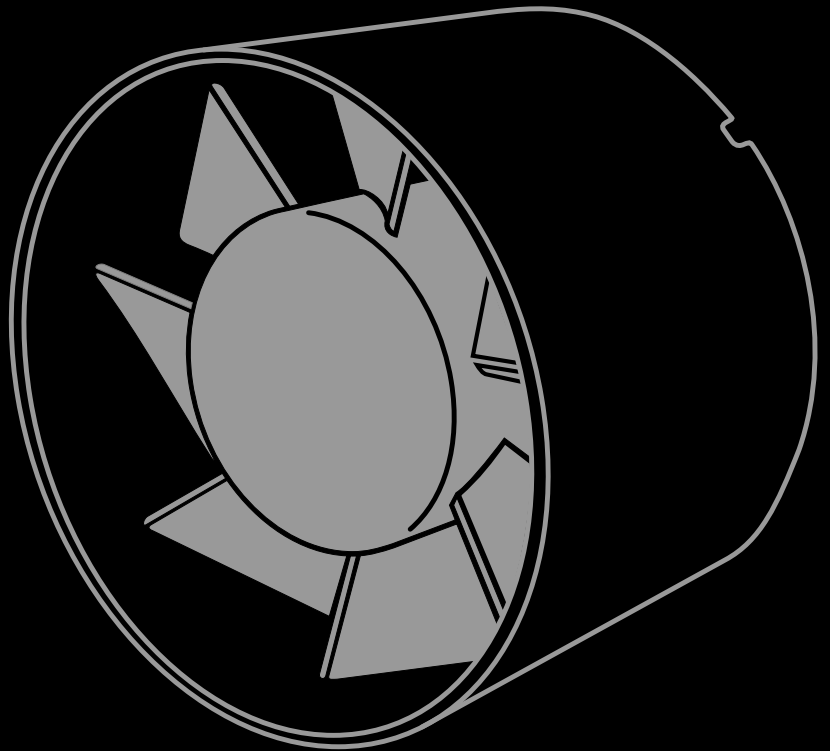

3 Sizes  
available



150

125

100

### AXIAL INLINE FAN

Diameter	Power	Speed	Air Flow
∅ 100 mm	15W	2.300 r/min	107 m3/h
∅ 125 mm	20W	2.400 r/min	190 m3/h
∅ 150 mm	30W	2.400 r/min	305 m3/h



# PUMPRO

PROFESSIONAL SPRAYER



# ACCESORIES

# PUMPRO+

PROFESSIONAL SPRAYER



## PROFESSIONAL SPRAYER

- 2 liters capacity
- Ergonomic handle
- Resistant pumping system
- Anticorrosive inox nozzle

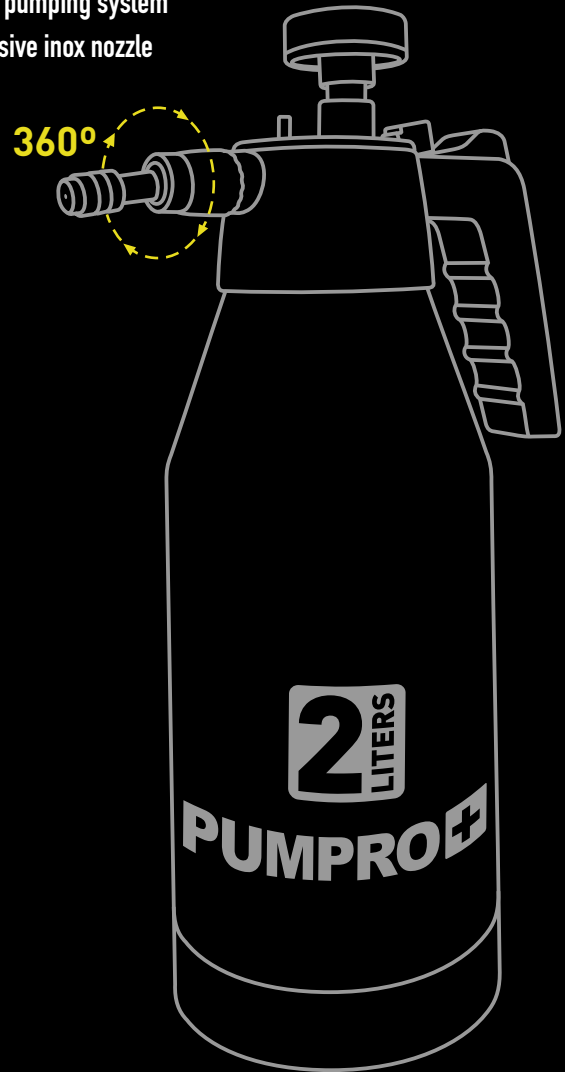

 ergonomic handle	<b>2L</b>	 resistant pumping system	 360° nozzle rotation
---	-----------	---	---

# HUMIPRO

DIGITAL HUMIDIFIER



# ACCESORIES



# HUMIPRO

DIGITAL HUMIDIFIER

## DIGITAL HUMIDIFIER

Digital panel LED control  
 Double Nozzle rotation 360°  
 4 liters capacity



 easy use	<b>4L</b>	 DIGITAL PANEL	 Rotate 360°
---	-----------	--	--

## HUMIPRO

Size	Capacity	Autonomy	Voltage/Frecuency
16x16x31.5cm	4 liters	24 hours	110V-220V 50/60Hz



# MEDIPRO+

INNOVATIVE PLANT GUARDIAN

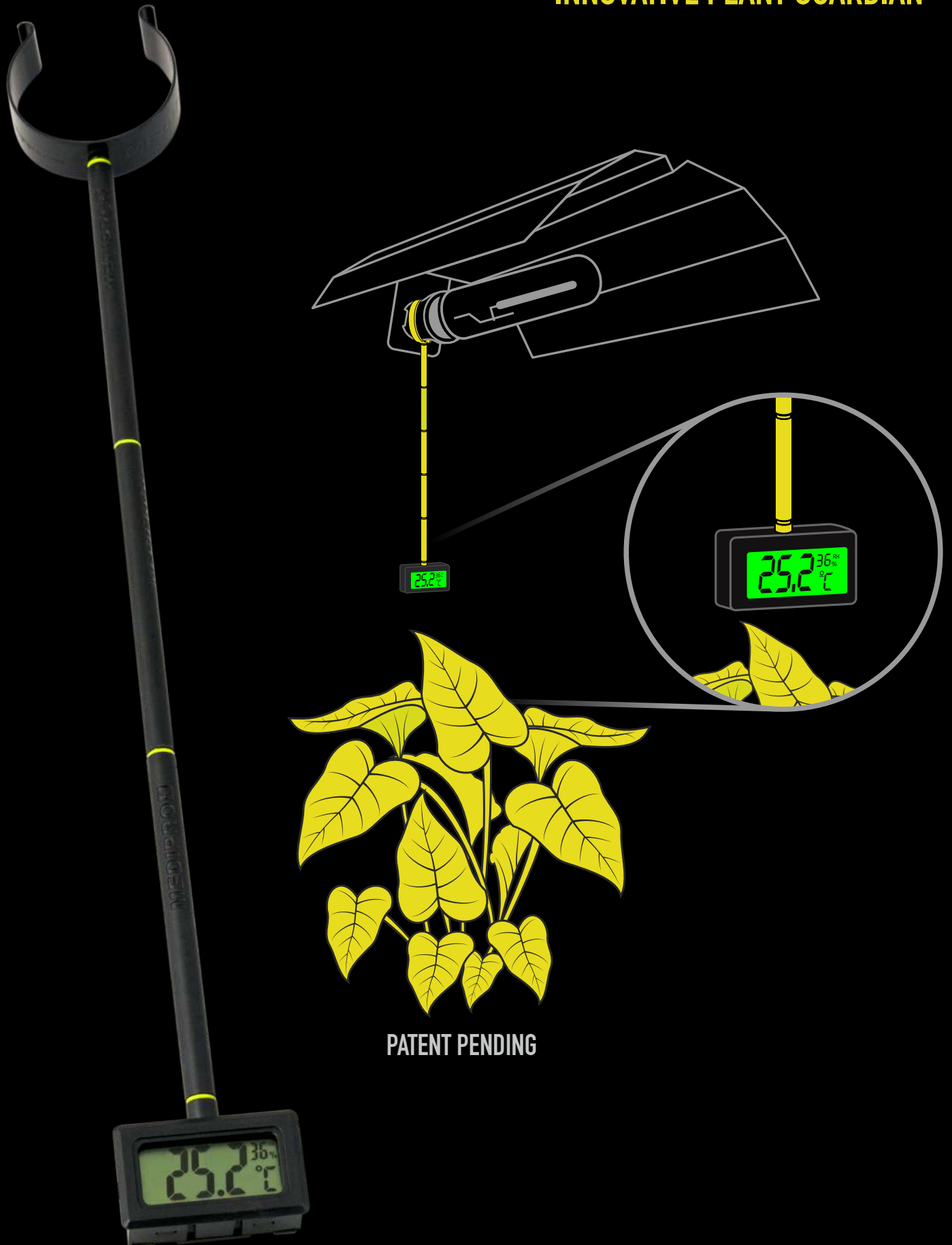

PATENT PENDING





## INNOVATIVE PLANT GUARDIAN

The best plants guardian of the industry  
 Fit all lamp holder - heat resistant  
 Modular system from 10cm up to 50cm

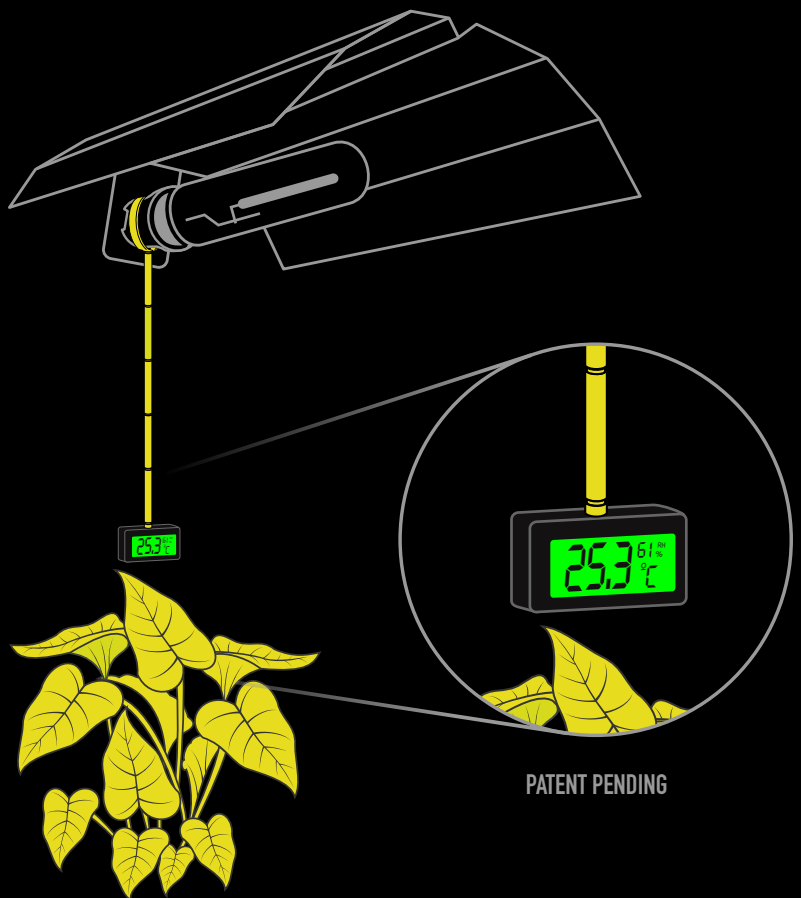

MEDIPRO Indicates the height between the top part of the plants and the bulb of the lamp, reducing the risk for the plants to get damaged for being too close to the heat generated by the bulb. Modular system: height can be modified from 10 up to 50cm (4in/20in). The incorporated hygrothermo indicates the temperature and humidity at the level of the plants.



# CLEARPRO+

PROTECTIVE GLASSES



sodium lamps



protection

# ACCESORIES



## THE BEST VISION FOR INDOOR GROWING

Sodium lamps rays eyes protector

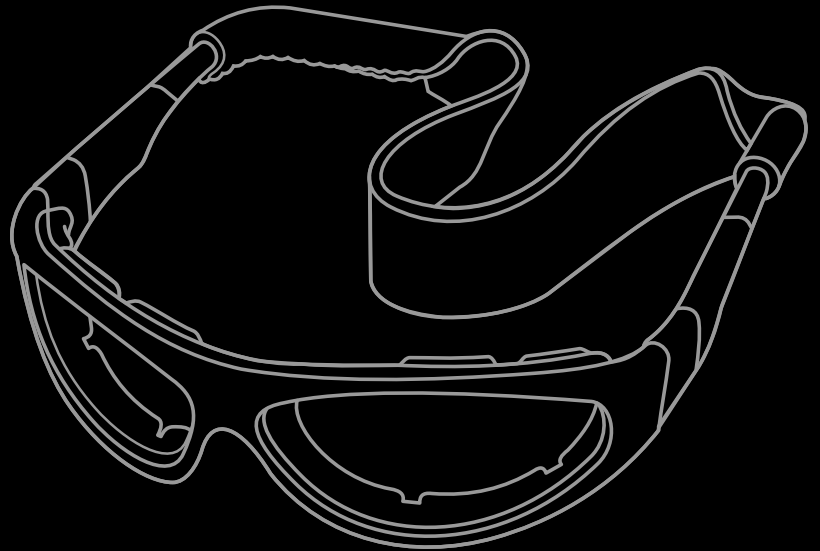

Clear View

**BQH**  
Best Quality HighPro



Light Proof



# PROHYGRO

HYGROTHERMO PRO



**LED Display**  
Green LED Display  
for not stressing  
the plants

**PROHYGROTHERMO **  
GARDEN HIGHPRO PREMIUM

MAX

CLEAR

GREEN  
LIGHT

MIN

°C/F



## HYGROTHERMO PRO



### HYGROTHERMO PRO

Accuracy	Battery incl.	Specifications
Precise Japanese Components	1.5 volt AAA	Indoor Thermometer with hygrometer Recording max./min. values every day Indoor-hygro range: 25% RH to 90% Temperature range: 0° - 50° / 32° - 122°F



# PROHYGRO

## HYGROTHERMOS





## HYGROTHERMO BASIC

Indoor Thermometer with hygrometer

Accuracy  $\pm 1^\circ\text{C}$  RH  $\pm 5\%$

Indoor-hygro range 25% RH to 90%

Temperature range:  $0^\circ - 50^\circ\text{C} / 32^\circ - 122^\circ\text{F}$



## HYGROTHERMO MEDIUM

Indoor Thermometer with hygrometer

Accuracy  $\pm 1^\circ\text{C}$  RH  $\pm 5\%$

Indoor-hygro range 25% RH to 90%

Temperature range:  $0^\circ - 50^\circ\text{C} / 32^\circ - 122^\circ\text{F}$

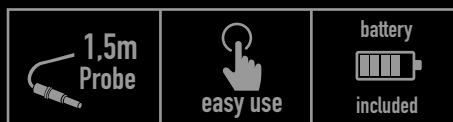

## HYGROTHERMO PREMIUM

Indoor Thermometer with hygrometer

Accuracy  $\pm 1^\circ\text{C}$  RH  $\pm 5\%$

Indoor-hygro range 25% RH to 90%

Temperature range:  $0^\circ - 50^\circ\text{C} / 32^\circ - 122^\circ\text{F}$



# PROCUFS

ROPE RATCHETS COMPLEMENT

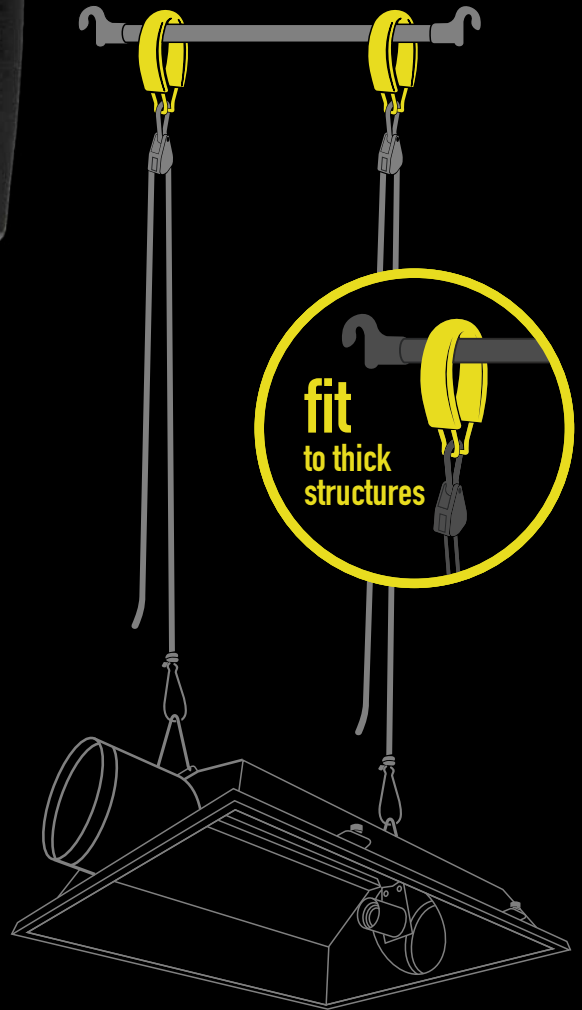





## PROCUFS ROPE RACHETS COMPLEMENT

Fit all type of tubes up to 5cm diameter

Ultra strong hanging capacity up to 84kg/pair

Ideal to secure heavy reflectors and carbon filters

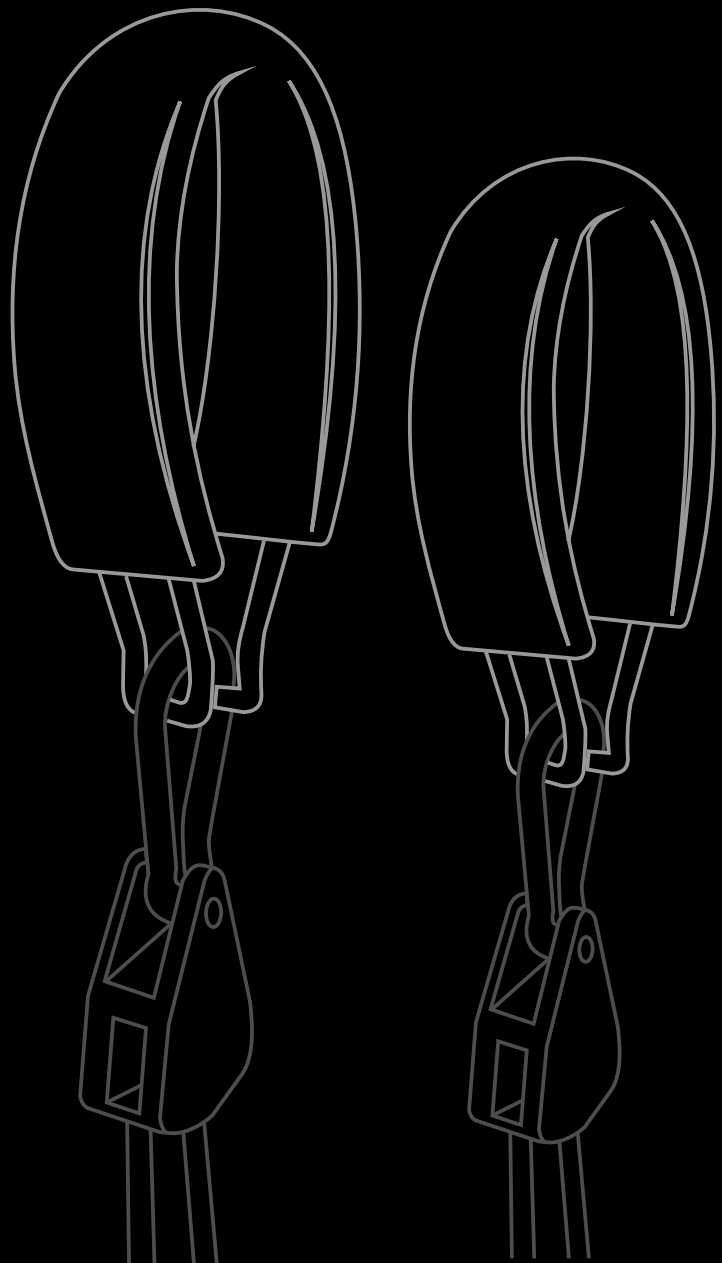

# PROHANGER

HIGH QUALITY ROPE RATCHET



# ACCESORIES

# PROHANGER+ HIGH QUALITY ROPE RATCHET



## PROHANGER LIGHANGER

Easier to use than conventional pulleys  
Regulate to the minimeter the height  
Fixing pulleys up to 5kg capacity  
1.05m rope lenght (3.4ft)

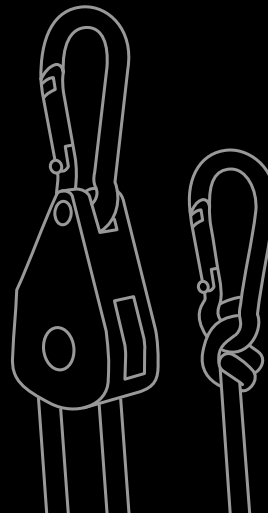
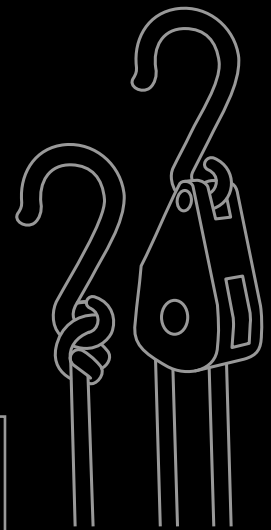

## PROHANGER REGULAR ROPE RATCHET

Strong and ultra resistant pulleys  
Ideal to sustain heavy carbon filters  
Fixing pulleys up to 68kg capacity  
1.5m rope lenght (4.3ft)

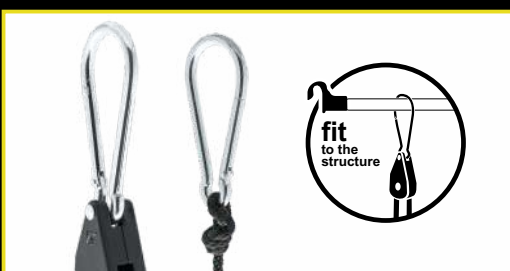

## PROHANGER XL CARABINER

Strong and ultra resistant pulleys  
XL carabiners that fit to the structure  
Fixing pulleys up to 68kg capacity  
1.5m rope lenght (4.3ft)

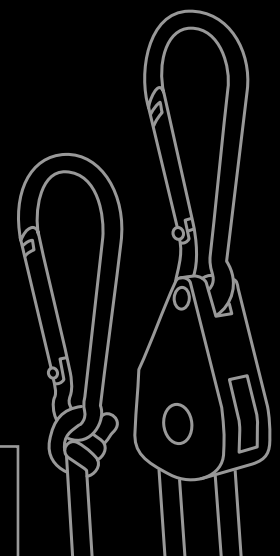
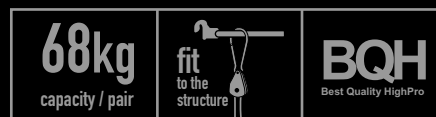

# PROCUTE

PRUNING SCISSORS





## PROCUT PRUNING SCISSORS

100% inox and extra sharp blades  
Specially designed for comfortable use  
Straight and curved blades versions available

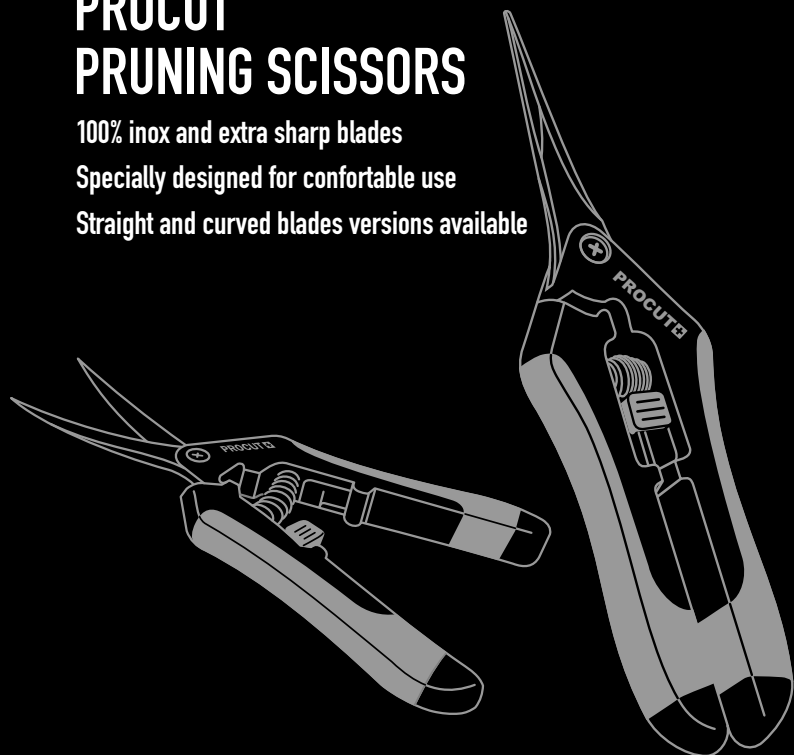

## PROCUT ONE EYE SCISSORS

100% inox and extra sharp blades  
Metalic edge for long lasting use  
Specially designed for comfortable use

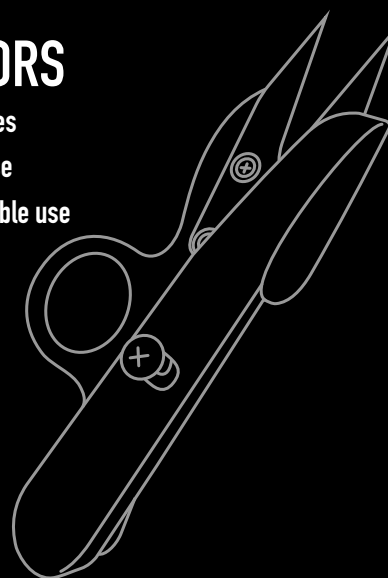
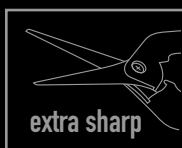

# PRO DRY

PROFESSIONAL DRYING SYSTEM



# ACCESORIES



## PRODRY MASTER PRIME DRYING SYSTEM

Drying net with removable racks  
Stabilizer band connecting each rack  
Strong clips for longer lasting  
High quality microperforated fabric

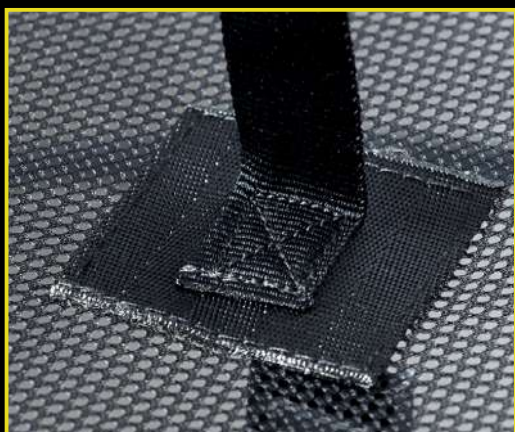
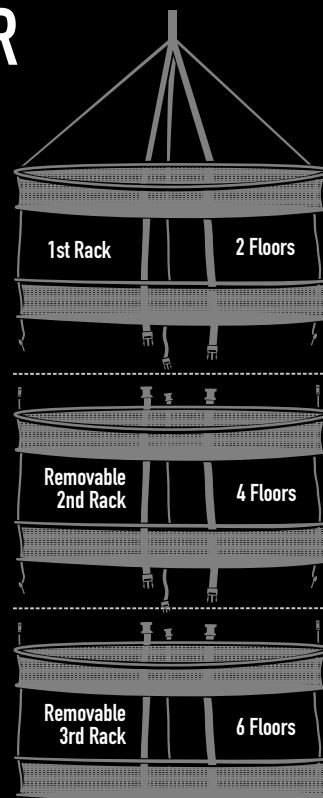

## PRODRY MASTER

Diameter	# Racks
∅ 55 cm	4 Racks
∅ 75 cm	6 Racks
∅ 95 cm	6 Racks



## PRODRY BASIC DRYING SYSTEM

High quality  
microperforated fabric



## PRODRY BASIC

Diameter	# Racks
∅ 55 cm	8 Racks
∅ 90 cm	8 Racks



# PRONET

MODULABLE ELASTIC NET

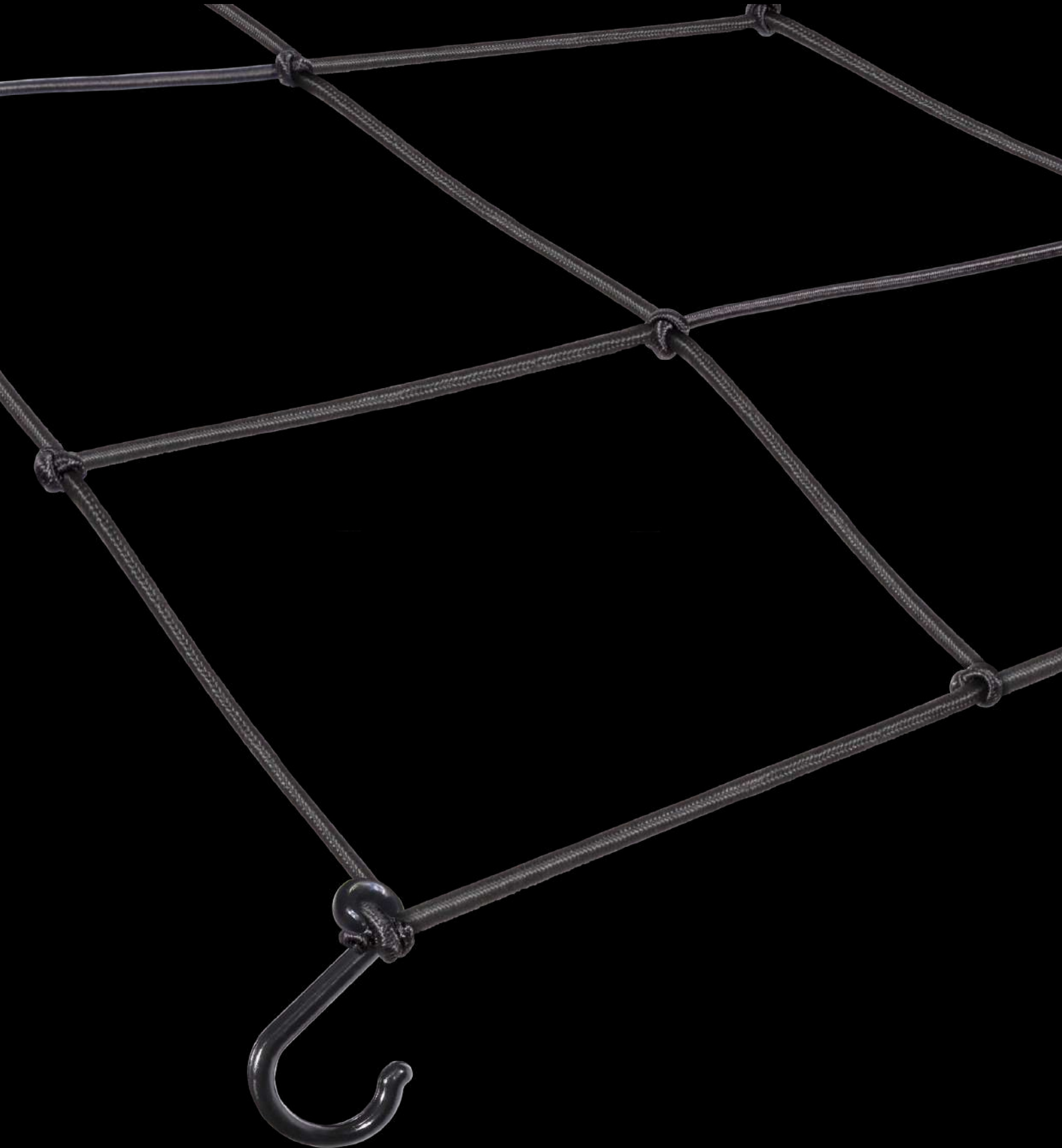



# ACCESORIES

# PRONET

MODULABLE ELASTIC NET

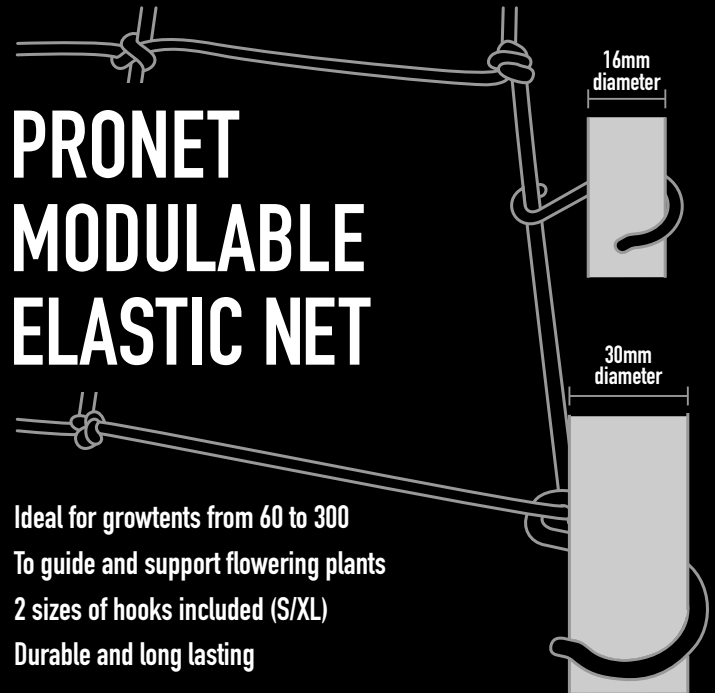
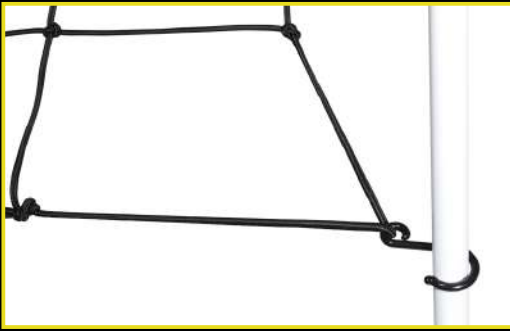

**64 Spaces**

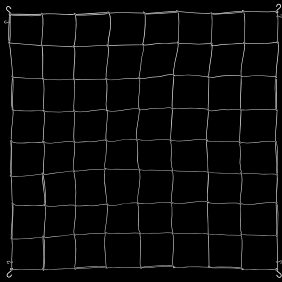

GROWING  
AREA UP TO  
150 x 150

**36 Spaces**

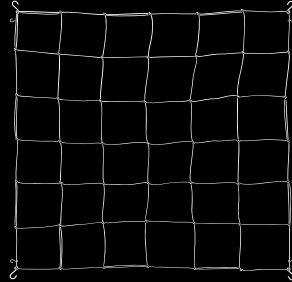

GROWING  
AREA UP TO  
120 x 120

**25 Spaces**

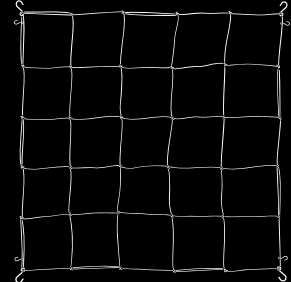

GROWING  
AREA UP TO  
100 x 100

**16 Spaces**

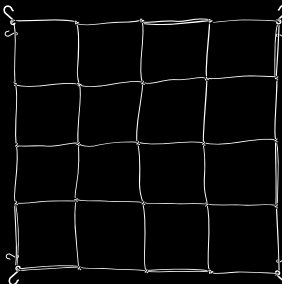

GROWING  
AREA UP TO  
80 x 80

**09 Spaces**

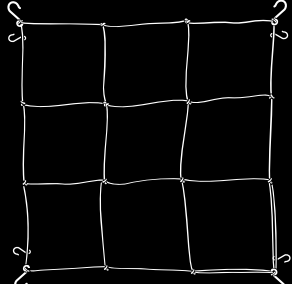

GROWING  
AREA UP TO  
60 x 60

## PRONET

References	Size	Grow Spaces
Pronet 120	60 x 60 cm	09 spaces
	80 x 80 cm	16 spaces
	100 x 100 cm	25 spaces
	120 x 120 cm	36 spaces
Pronet 150	150 x 150 cm	64 spaces

# SOILPRO+

PROFESSIONAL SUBSTRATE

**5L FREE**  
**50+5=55L**



## SOILPRO+

PROFESSIONAL SUBSTRATE

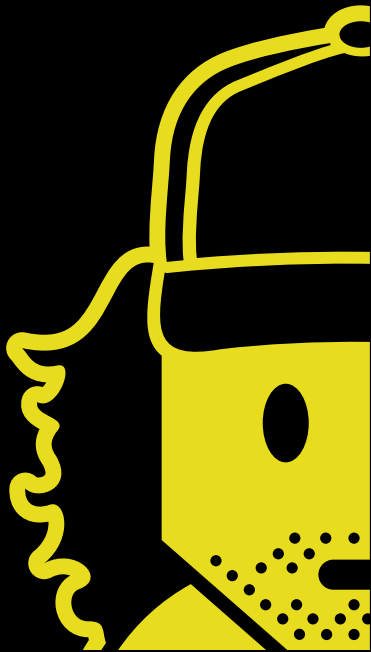

### LIGHTMIX SUBSTRATE



GARDEN  
HIGHPRO



PH 6.2

EC 1.2

GARDEN  
HIGHP

# POTS

# SOILPRO+

PROFESSIONAL SUBSTRATE



## LIGHTMIX SUBSTRATE

SOILPRO PROFESSIONAL SUBSTRATE from GARDEN HIGHPRO comprises top quality peat and a high percentage of coconut, which boosts root development and favours water retention. SOILPRO PROFESSIONAL SUBSTRATE is a fine particle substrate that does not contain heavy metals for indoor and outdoor plants. Recommended for all types of plants, flowers, vegetables and herbs.



PH 6.2

EC 1.2



### PROFESSIONAL SUBSTRATE

#### Main Components

- Dark peat
- Moss peat
- Coconut fibre
- Perlite
- Humic and fulvic acids

NPK 14/12/18 / EC: 1.2 / pH: 6.2



# PROPOT

ACTIVE FABRIC POTS



# POTS

# PROPOT+ ACTIVE FABRIC POTS



## FABRIC POTS

Very strong and reusable

Square based to optimise the growing space

Ideal for indoor and outdoor growing

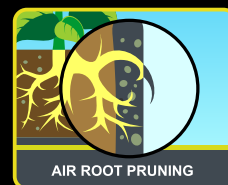
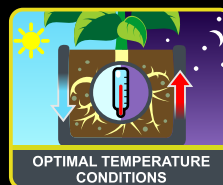
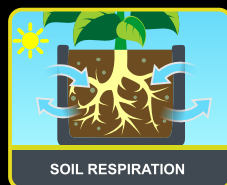

## ACTIVE FABRIC POTS

Capacity	Sizes	Handles
1.5 Liters	10 x 10 x 21 cm	no
4 Liters	15 x 15 x 20 cm	no
7 Liters	18 x 18 x 23 cm	no
11 Liters	23 x 23 x 25 cm	no
15 Liters	23 x 23 x 28 cm	2 units
20 Liters	26 x 26 x 30 cm	2 units
30 Liters	30 x 30 x 33 cm	2 units
50 Liters	33 x 33 x 46 cm	2 units

# PROPOT

ACTIVE FABRIC POTS

## PROPOT WALL



# POTS

# PROPOT+

ACTIVE FABRIC POTS

## PROPOT WALL 12

90x100 cm

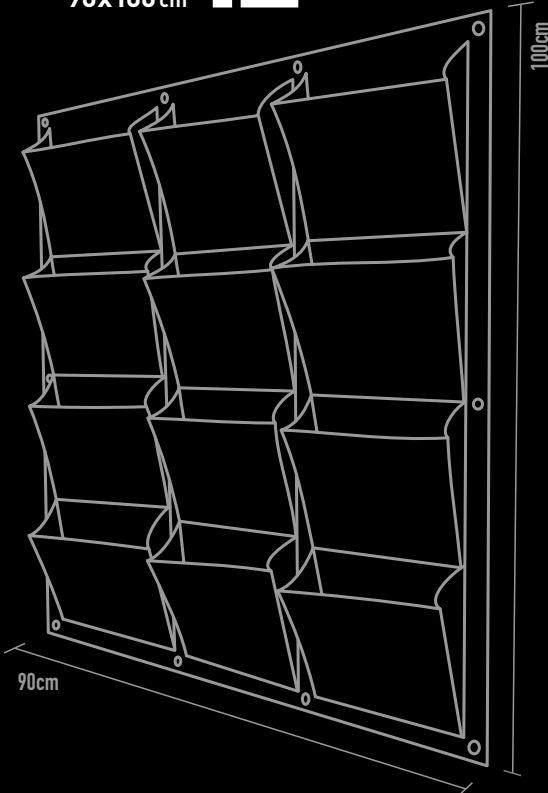

## PROPOT WALL 8

60x100 cm

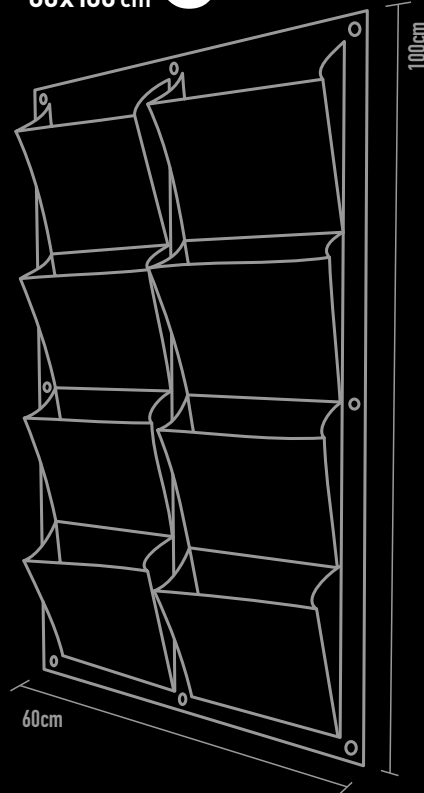

## PROPOT WALL 4

30x100 cm

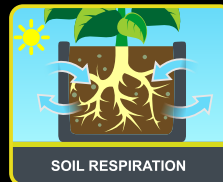
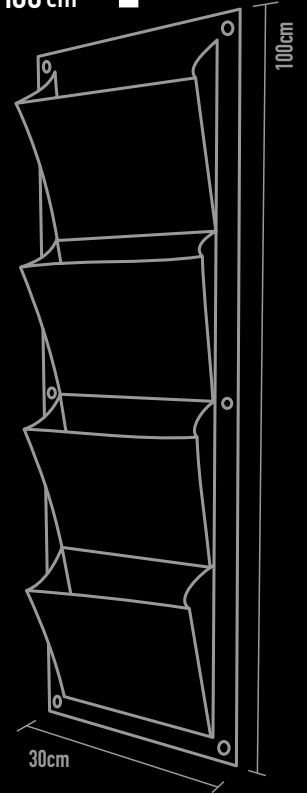

SOIL RESPIRATION

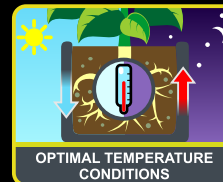

OPTIMAL TEMPERATURE CONDITIONS

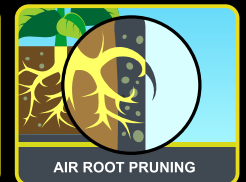

AIR ROOT PRUNING

## PROPOT WALL

Very strong and reusable

Variety of plant pockets 4 / 8 / 12

Ideal for indoor and outdoor growing

The roots can breath properly

### Specifications

Propot Wall 4 - width x hight	30 x 100 cm
Propot Wall 8 - width x hight	60 x 100 cm
Propot Wall 12 - width x hight	90 x 100 cm

# PANZERKUSH

## FEMINIZED SEEDS

8-9 SEMANAS



FEMINIZED SEEDS

70% ÍNDICA  
30% SATIVA



90% KOSHERKUSH &  
ORANGE BLOSSOM

450 A 550 G/M<sup>2</sup>



SWEET ANISATED CITRIC



SPECIAL MENTION FOR **PANZERKUSH** IN MAUA GREEN CUP



GARDEN  
HIGHPRO





# DUDAS DE CULTIVO? / GROWING DOUBTS?

HABLA CON UN EXPERTO

CHAT WITH AN EXPERT

## DR GROWMAN LIVE CHAT GRATUITO / FREE

01. ENTRA EN NUESTRA WEB Y REGÍSTRATE ...  
ENTER IN OUR WEBSITE AND REGISTER ...

[WWW.GARDENHIGHPRO.COM](http://WWW.GARDENHIGHPRO.COM)



02. ...CHATEA CON  
EL DOCTOR...  
...CHAT WITH  
THE DOCTOR ...

... ADEMÁS PUEDES PEDIRLE  
DIAGNÓSTICOS ENVIANDO FOTOS  
...YOU CAN ALSO ASK FOR  
DIAGNOSIS BY  
SENDING PICTURES



# TE GUSTA CULTIVAR? / DO YOU LIKE TO GROW?

DESCUBRE LOS MEJORES TRUCOS

DISCOVER THE BEST TIPS



DESCARGA  
NUESTRA GUÍA GRATIS  
DOWNLOAD  
OUR FREE GUIDE

DISPONIBLE EN 9 IDIOMAS  
AVAILABLE IN 9 LANGUAGES



# **BORN**  
TO BE A  
**GROWER**



**GARDEN  
HIGHPRO**



[WWW.GARDENHIGHPRO.COM](http://WWW.GARDENHIGHPRO.COM)



**NOT FOR RESALE**  
PROMOTIONAL USE ONLY

GH-Z-193-EN

