

SY206-SF4SNM(E) Yagi directional, 9.5 dBd, end mount, 162-169 MHz

Also referred as: SRL206EBNM*4

- Six element extended boom yagi
- Outstanding durability and performance
- DC ground potential for lightning protection

The SY206 antenna consists of a six-element yagi of outstanding durability and performance. All elements including the folded dipole are maintained at DC Ground potential for lightning protection. All elements on this antenna are attached to the boom with solid cast aluminum clamps.

This highly versatile antenna is supplied as a standard mount yagi, or, as an end-boom mounted unit.

As with other yagis, this VHF antenna is available in multiple-unit arrays for added gain. Horizontally or vertically parallel kits of 'H' frames can readily be supplied to mount two or four yagis with a common feed.

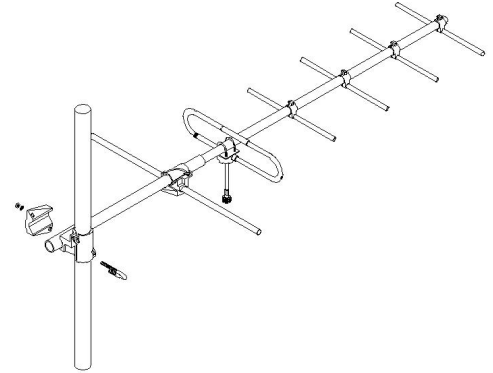

www.sinctech.com

Region	United States	Europe, Middle East and Africa	Caribbean and Latin America	Canada and rest of the world
Telephone	USA: 1 800 263 3275	International: +44 (0) 1487 84 28 19	International: +1 905 726 7676	Canada: 1 800 263 3275 International: +1 905 727 0165
E-mail	salesusa@sinctech.com	salesuk@sinctech.com	salesla@sinctech.com	salescan@sinctech.com

Product Specification Sheet
EPR 017687

SY206-SF4SNM(E)

Issue: 6

Dated: 14-12-16
Dated: 17-01-14

Electrical Specifications

Frequency Range	MHz	162 to 169
Bandwidth	MHz	7
Connector		N-Male
Gain (nominal)	dBd (dBi)	9.5 (11.6)
Input VSWR (max)		1.5:1
Polarization		vertical or horizontal
Pattern		Directional
Horizontal beamwidth (typ)	degrees	56
Vertical beamwidth (typ)	degrees	46
Average Power Input (max)	W	200
Lightning protection		DC ground
Front-to-back ratio (typ)	dB	17

Mechanical Specifications

Width	in (mm)	42 (1067)
Depth	in (mm)	6.1 (155)
Length/ Height	in (mm)	113.38 (2880)
Radiating element material		aluminum
Reflector material		aluminum
Weight	lbs (kg)	12.5 (5.68)
Weight iced (1/2" ice)	lbs (kg)	43.5 (19.75)
Mounting Hardware (Included)		Clamp001
Actual shipping weight	lbs (kg)	45 (20.43)
Shipping dimensions	in (mm)	127x8x7 (3226x203x178)

Environmental Specifications

Temperature range	°F (°C)	-40 to +140 (-40 to +60)
Wind Loading Area (Flat Plate Equivalent)	ft² (m²)	1.92 (0.18)
Wind Loading Area (1/2" ice)	ft² (m²)	3.75 (0.35)
Rated wind velocity (no ice)	mph (km/h)	130 (209)
Rated wind velocity (1/2" radial ice)	mph (km/h)	85 (137)
Lateral thrust (100 mph No Ice)	lbs (N)	72 (320.3)
Bending moment (100 mph No Ice)	ft-lbs (Nm)	333 (449.6)

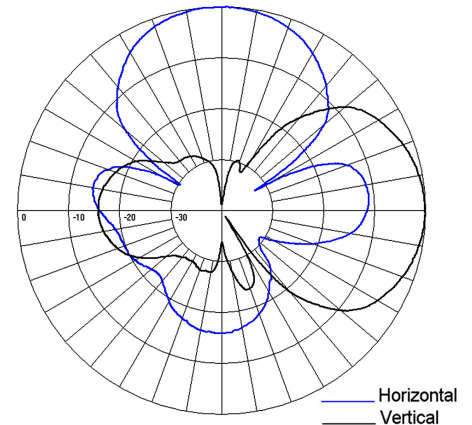

Region	United States	Europe, Middle East and Africa	Caribbean and Latin America	Canada and rest of the world
Telephone	USA: 1 800 263 3275	International: +44 (0) 1487 84 28 19	International: +1 905 726 7676	Canada: 1 800 263 3275 International: +1 905 727 0165
E-mail	salesusa@sinctech.com	salesuk@sinctech.com	salesla@sinctech.com	salescan@sinctech.com