

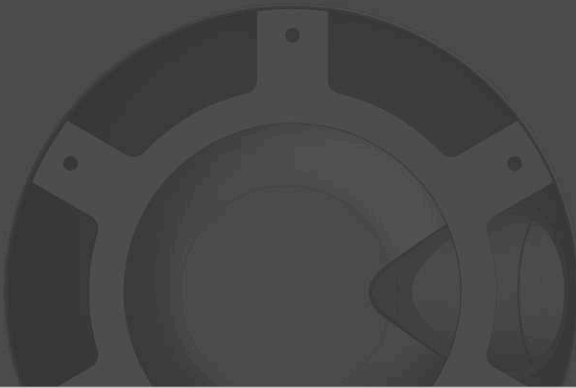

# THUNDERBIRD PRODUCTS



**DRAINS - VENTS - EDGE METAL - PRESS BRAKE - WATERJET**





# THUNDERBIRD PRODUCTS

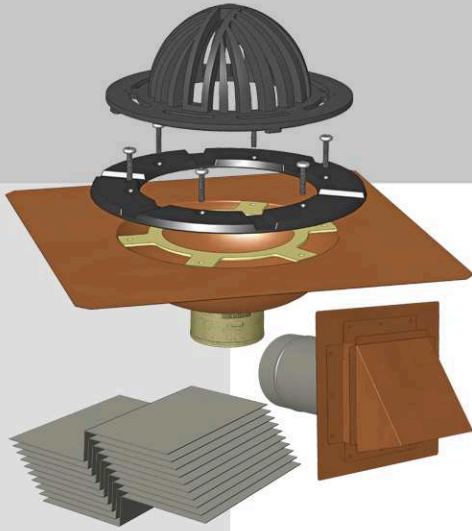

For over 35 years our company has manufactured roof drains, deck drains, and vents in the USA. We strive to provide our customers with a high-quality American-made product while maintaining a level of customer service and satisfaction that will garner repeat business.

Offering a wide variety of residential and commercial products and services including:

- + The original seamless drain basin roof drains
- + Parapet wall, scupper, deck and balcony drains
- + Custom sheet metal fabrication including edge metal and flashings
- + Now carrying TPO/PVC-clad stainless steel



Many of our roof and deck drains are listed by ICC-ES PMG.

## Press Brake Services

Thunderbird's press brake services cater to San Diego county's sheet metal and job shop needs, using leading edge computer-aided methods for our metal bending and design services.

At our disposal are:

- 130 ton, 12' Accurpress press brake
- 10' Roper Whitney folding machine and shear

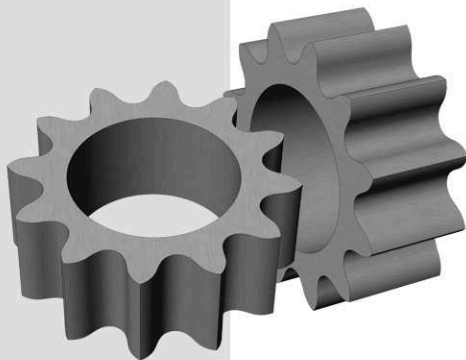
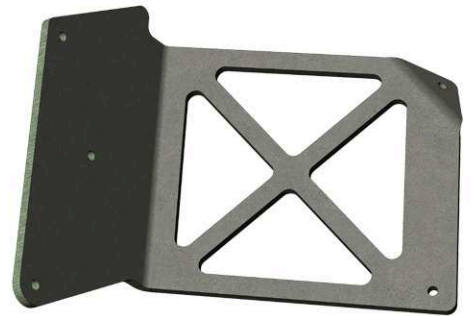

## Waterjet Services

Thunderbird Products Waterjet Services has one of the largest waterjet cutting capacities not just in San Diego, but all of Southern California with three Omax waterjet cutting machines and dedicated technicians.

Our experienced staff is very knowledgeable in using CAD/CAM technology, and can import just about any type of file. Finished parts are verified to meet tolerances required.

With over 35 years of experience, great customer service and competitive pricing, we truly are a one-stop shop.

If you are interested in a free quote or would like to speak to any of our technicians, call us at **(800) 658-2473** or email us at **sales@tbirdusa.com**.

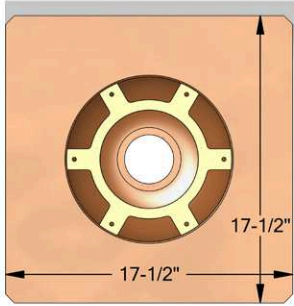

**Bottom Outlet Roof Drain**  
ICC-ES PMG-1212

- |       |                |
|-------|----------------|
| RD2TA | 2" male thread |
| RD2NH | 2" no-hub      |
| RD3NH | 3" no-hub      |
| RD4NH | 4" no-hub      |

Add CR to part # for membrane clamp

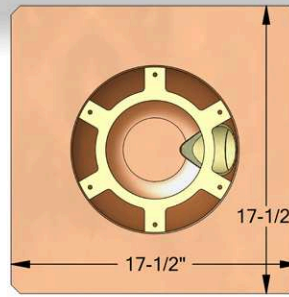

**Side Outlet Roof Drain**  
ICC-ES PMG-1212

- |         |                |
|---------|----------------|
| RDHZ2TA | 2" male thread |
| RDHZ2NH | 2" no-hub      |
| RDHZ3NH | 3" no-hub      |
| RDHZ4NH | 4" no-hub      |

Add CR to part # for membrane clamp

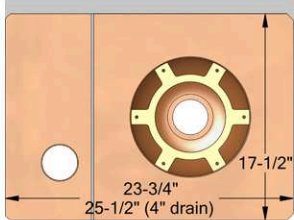
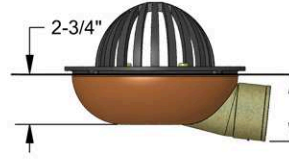

**Bottom Outlet Roof Drain w/ Overflow**  
ICC-ES PMG-1212

- |         |                |
|---------|----------------|
| RDCB2TA | 2" male thread |
| RDCB2NH | 2" no-hub      |
| RDCB3NH | 3" no-hub      |
| RDCB4NH | 4" no-hub      |

Add CR to part # for membrane clamp

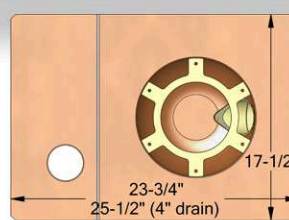

**Side Outlet Roof Drain w/ Overflow**  
ICC-ES PMG-1212

- |           |                  |
|-----------|------------------|
| RDCBHZ2TA | * 2" male thread |
| RDCBHZ2NH | 2" no-hub        |
| RDCBHZ3NH | 3" no-hub        |
| RDCBHZ4NH | 4" no-hub        |

Add CR to part # for membrane clamp

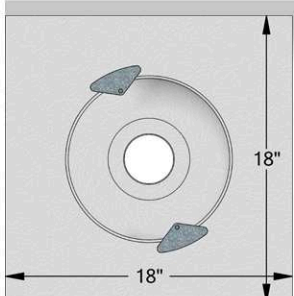

**TPO/PVC-Clad Bottom Outlet Roof Drain**

- |           |                |
|-----------|----------------|
| TPO-RD2TA | 2" male thread |
| TPO-RD2NH | 2" no-hub      |
| TPO-RD3NH | 3" no-hub      |
| TPO-RD4NH | 4" no-hub      |

For PVC part # replace TPO with PVC

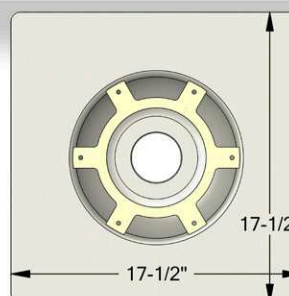
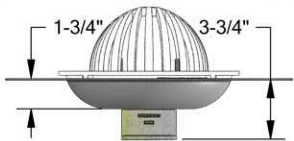

**Stainless Steel Bottom Outlet Roof Drain**

- |         |                |
|---------|----------------|
| S-RD2TA | 2" male thread |
| S-RD2NH | 2" no-hub      |
| S-RD3NH | 3" no-hub      |
| S-RD4NH | 4" no-hub      |

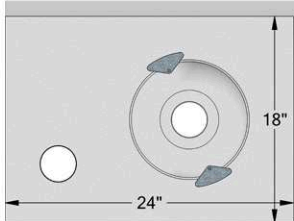

**TPO/PVC-Clad Bottom Outlet Roof Drain w/ Overflow**

- |             |                |
|-------------|----------------|
| TPO-RDCB2TA | 2" male thread |
| TPO-RDCB2NH | 2" no-hub      |
| TPO-RDCB3NH | 3" no-hub      |
| TPO-RDCB4NH | 4" no-hub      |

For PVC part # replace TPO with PVC

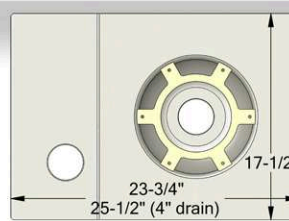

**Stainless Steel Bottom Outlet Roof Drain w/ Overflow**

- |           |                |
|-----------|----------------|
| S-RDCB2TA | 2" male thread |
| S-RDCB2NH | 2" no-hub      |
| S-RDCB3NH | 3" no-hub      |
| S-RDCB4NH | 4" no-hub      |



\* excluded from ICC-ES listing

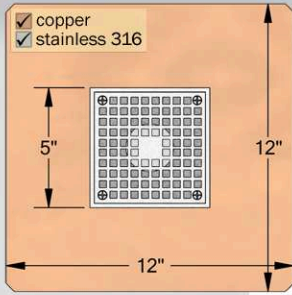

**Tile Deck Drain**

- BDCD3NH 3" no-hub
- BDCD3NH90 3" no-hub w/ 90°
- BDCD42NH 4" bowl to 2" no-hub
- BDCD42NH90 4" bowl to 2" w/ 90°
- BDCD43NH 4" bowl to 3" no-hub
- BDCD43NH90 4" bowl to 3" w/ 90°

Add CR to part # for membrane clamp

- Add for grate type/material:
- SQ square, nickel-bronze
  - RN round, bronze
  - TI square tile insert, stainless

- Grate finish options:
- CG polished chrome
  - ORB oil-rubbed bronze

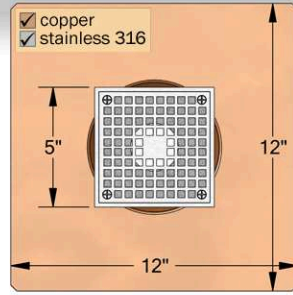
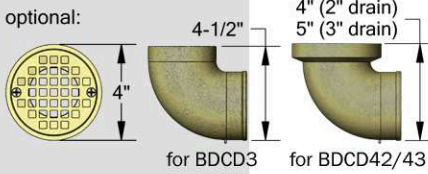
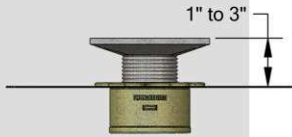

**Recessed Tile Deck Drain**

- BDCDR3NH 3" no-hub
- BDCDR3NH90 3" no-hub w/ 90°

Add for grate type/material:

- SQ square, nickel-bronze
- RN round, bronze

Grate finish options:

- CG polished chrome
- ORB oil-rubbed bronze

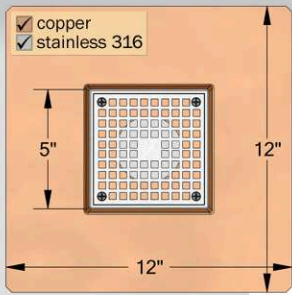
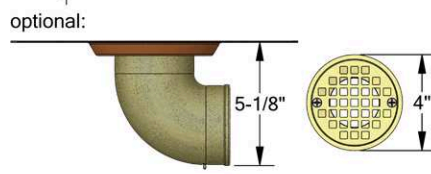
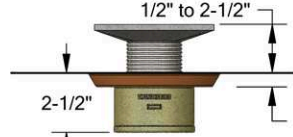

**Square Top Bowl Deck Drain**

- BDSQ2NH 2" no-hub
- BDSQ2NH90 2" no-hub w/ 90°
- BDSQ3NH 3" no-hub
- BDSQ3NH90 3" no hub w/ 90°

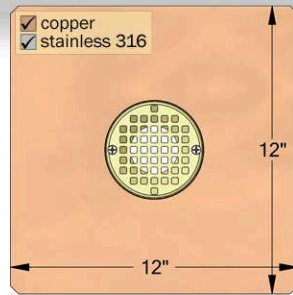
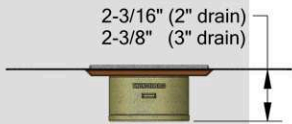
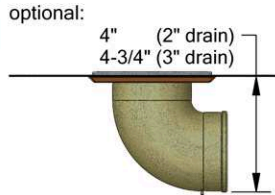

**Bowl Deck Drain**

- BD42NH 4" bowl to 2" no-hub
- BD42NH90 4" bowl to 2" no-hub w/ 90°
- BD43NH 4" bowl to 3" no-hub
- BD43NH90 4" bowl to 3" no-hub w/ 90°

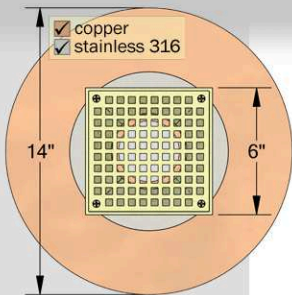
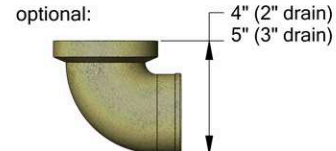

**Commercial Tile Deck Drain w/ Adjustable Grate**  
ICC-ES PMG-1212

- BD62A 2" no-hub
- BD63A 3" no-hub
- BD64A \* 4" no-hub

Add CR to part # for membrane clamp

- Add for grate type:
- SQ square, brass
  - RN \* round, brass
  - RNHV round, high volume, brass

- Grate finish options:
- CG polished chrome
  - ORB oil-rubbed bronze

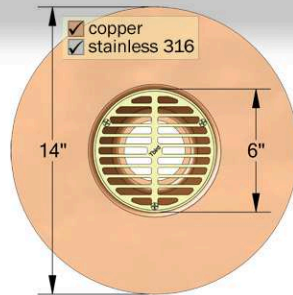
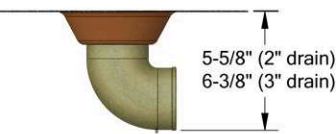
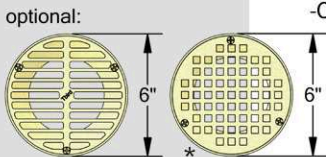

**Commercial Thin Membrane Drain**  
ICC-ES PMG-1212

- BD62F 2" no-hub
- BD63F 3" no-hub
- BD64F \* 4" no-hub

- Add for grate type:
- RN \* round, brass
  - RNHV round, high volume, brass

- Grate finish options:
- CG polished chrome
  - ORB oil-rubbed bronze

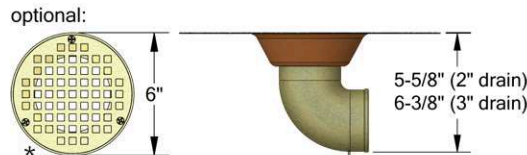
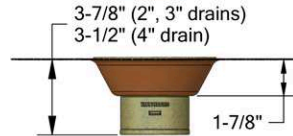

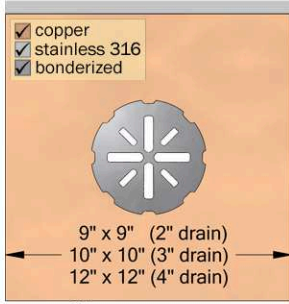

**Balcony Deck Drain**  
ICC-ES PMG-1212

- BD2TA 2" male thread
- BD2NH 2" no-hub
- BD2NH90 2" no-hub w/ 90°
- BD3NH 3" no hub
- BD3NH90 3" no-hub w/ 90°
- BD4NH \* 4" no-hub

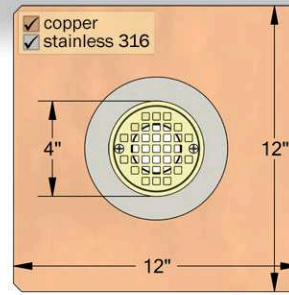
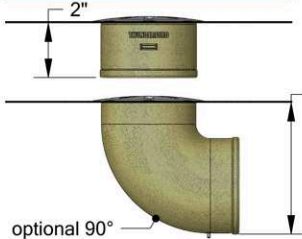

**Shower Drain**  
ICC-ES PMG-1335

- SD2NH 2" no-hub
- SD2NH90 2" no-hub w/ 90°
- SD3NH \* 3" no-hub
- SD3NH90 \* 3" no-hub w/ 90°

Add for grate type/material:  
-SQ square, nickel-bronze  
-SQTG square, tile-in, stainless  
-RN round, bronze

Grate finish options:  
-CG polished chrome  
-ORB oil-rubbed bronze

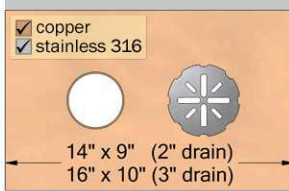
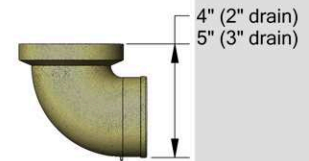
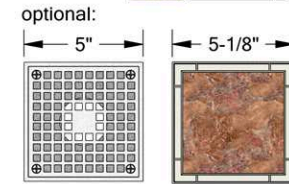
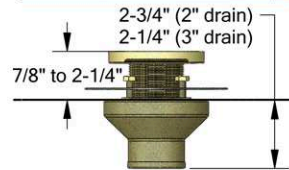

**Balcony Deck Drain w/ Overflow**

- BDCB2TA 2" male thread
- BDCB2NH 2" no-hub
- BDCB2NH90 2" no-hub w/ 90°
- BDCB3NH 3" no hub
- BDCB3NH90 3" no hub w/ 90°

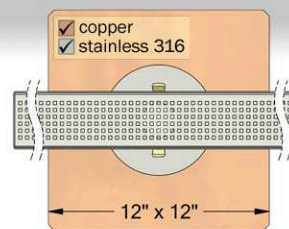
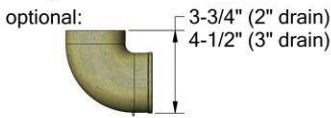

**Linear Shower Drain**  
ICC-ES PMG-1335

- SDLN30 2" no-hub, 30" grate
- SDLN36 2" no-hub, 36" grate
- SDLN48 2" no-hub, 48" grate
- SDLN60 2" no hub, 60" grate

Add for grate type:  
-SG perforated, stainless  
-TG tile-in, stainless

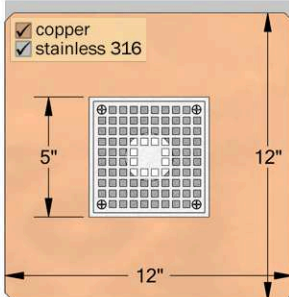
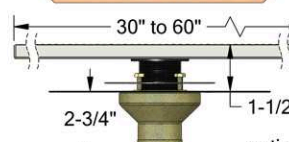

**Dual Membrane Deck Drain**

- BDDM3NH 3" no-hub
- BDDM3NH90 3" no-hub w/ 90°

Add for grate type/material:  
-SQ square, nickel-bronze  
-RN round, bronze

Grate finish options:  
-CG polished chrome  
-ORB oil-rubbed bronze

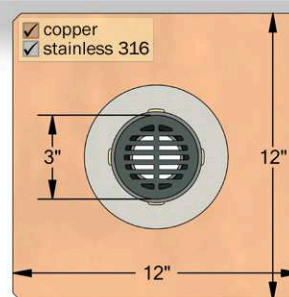
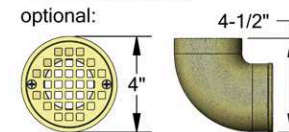
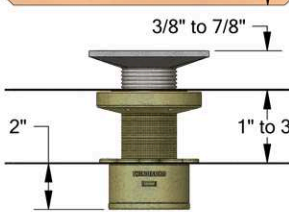

**Planter Box Drain**

- BDPB2NH 2" no-hub
- BDPB3NH 3" no-hub

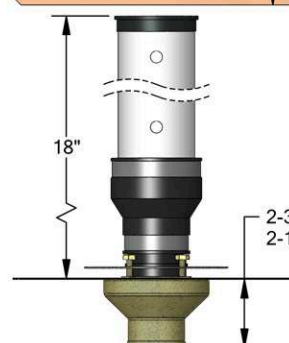

\* excluded from ICC-ES listing

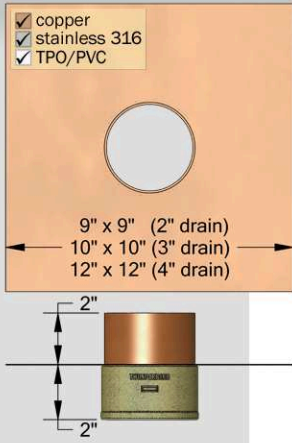

**Separate Overflow Drain**  
ICC-ES PMG-1212

- OF2TA \* 2" male thread
- OF2NH 2" no-hub
- OF2NH90 2" no-hub w/ 90°
- OF3NH 3" no hub
- OF3NH90 3" no-hub w/ 90°
- OF4NH 4" no-hub

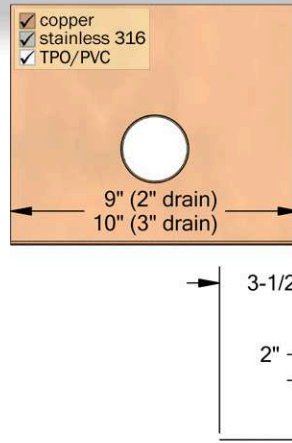
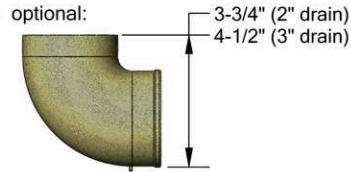

**Parapet Overflow Drain**

- OF-PP2NH 2" no-hub
- OF-PP3NH 3" no-hub

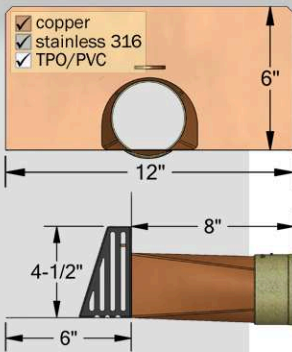
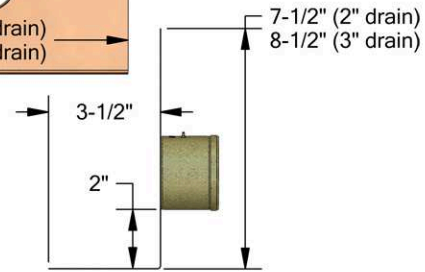

**Through-Wall Parapet Drain**  
ICC-ES PMG-1212

- PDSR2NH 2" no-hub
- PDSR3NH 3" no-hub
- PDSR4NH \* 4" no-hub

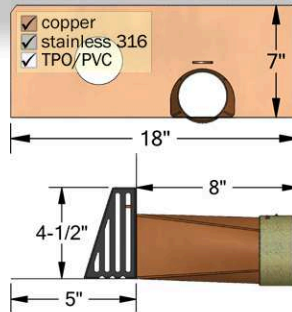

**Through-Wall Parapet Drain w/ Overflow**  
ICC-ES PMG-1212

- PDSRCB2NH 2" no-hub
- PDSRCB3NH 3" no-hub
- PDSRCB4NH \* 4" no-hub

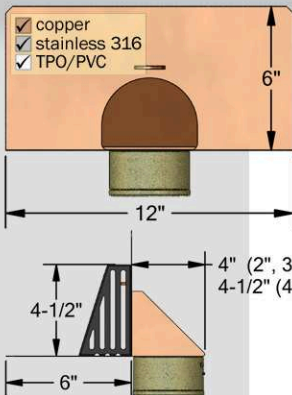

**Inside-Wall Parapet Drain**  
ICC-ES PMG-1212

- PDND2NH 2" no-hub
- PDND3NH 3" no-hub
- PDND4NH \* 4" no-hub

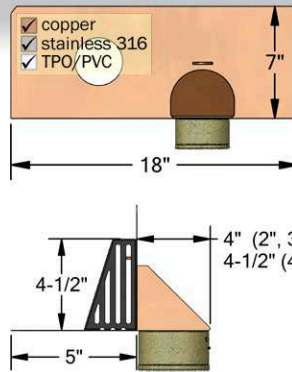

**Inside-Wall Parapet Drain w/ Overflow**  
ICC-ES PMG-1212

- PDNDCB2NH 2" no-hub
- PDNDCB3NH 3" no-hub
- PDNDCB4NH \* 4" no-hub

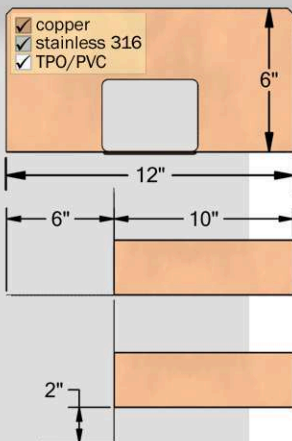

**Scupper**

- PS32 3" wide x 2" high
- PS43 4" wide x 3" high
- PS44 4" wide x 4" high
- PS64 6" wide x 4" high
- PS66 6" wide x 6" high

Add for alternative configurations:  
OF- overflow configuration  
-C corner configuration

Custom sizes and lengths available

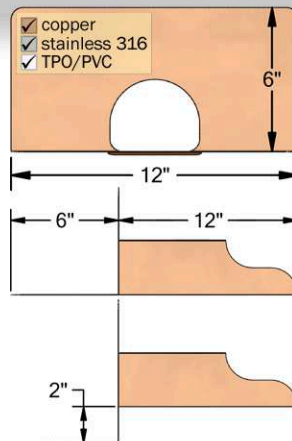

**Decorative Scupper**

- PSD32 3" wide x 2" high
- PSD43 4" wide x 3" high
- PSD44 4" wide x 4" high
- PSD64 6" wide x 4" high
- PSD66 6" wide x 6" high

Add for alternative configurations:  
OF- overflow configuration  
-C corner configuration

Custom sizes and lengths available



**Cast Aluminum Dome**  
Fits all Thunderbird Roof Drains

A-1-DOME-AL      strainer, black

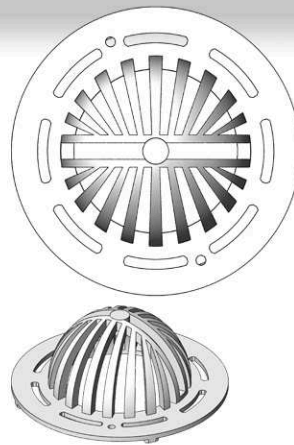

**ABS Dome**  
Fits all Thunderbird Roof Drains

A-1-DOME      strainer, black  
A-1-DOME-W      strainer, white

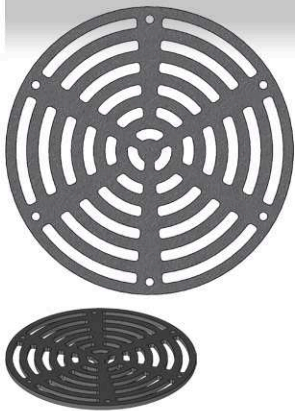

**Flat Grate**  
Fits all Thunderbird Roof Drains

A-FLAT-GRATE      plastic, black  
A-FLAT-GRATE-C      copper  
A-FLAT-GRATE-S      stainless steel

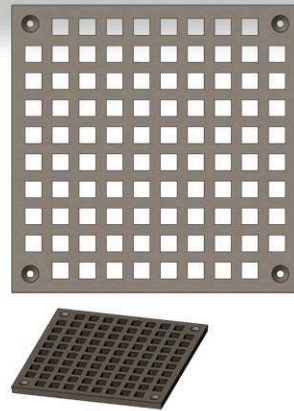

**Square Grate**  
Fits BD6A Deck Drain

14.38 in<sup>2</sup> of grate-free area  
  
Available in the following finishes:  
brass  
polished chrome  
oil-rubbed bronze (as shown)

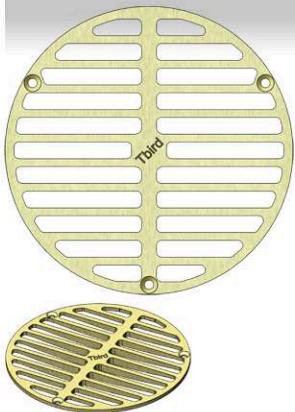

**High Volume Round Grate**  
Fits BD6A/F Deck Drain

14.15 in<sup>2</sup> of grate-free area  
  
Available in the following finishes:  
brass (as shown)  
polished chrome  
oil-rubbed bronze

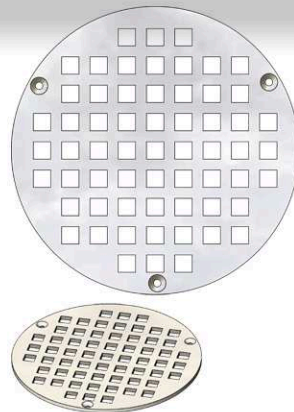

**Round Grate**  
Fits BD6A/F Deck Drain

10.94 in<sup>2</sup> of grate-free area  
  
Available in the following finishes:  
brass  
polished chrome (as shown)  
oil-rubbed bronze

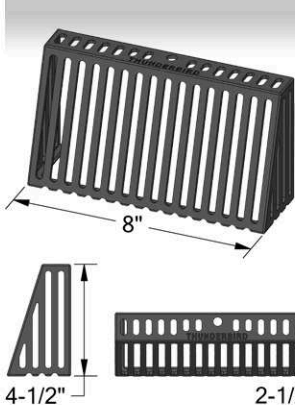

**Cast Aluminum Parapet Grate**  
Fits all Thunderbird Parapet Drains

A-PDGRATE      strainer, black

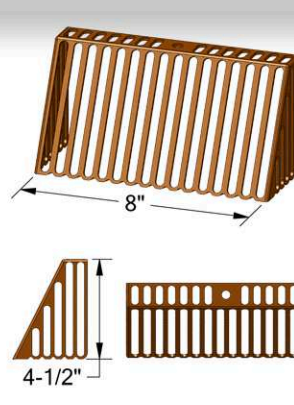

**Copper Parapet Grate**  
Fits all Thunderbird Parapet Drains

A-PDGRATE-C      strainer, copper

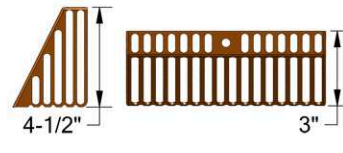
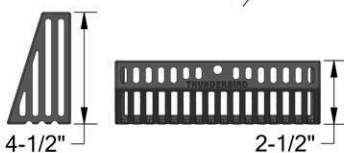

**Half-Round Louvered Dormer Vent**

RM-DHR18 18" wide  
RM-DHR24 24" wide

Detailed dimensions at [tbirdusa.com](http://tbirdusa.com)

- copper
- hammered copper
- stainless 316

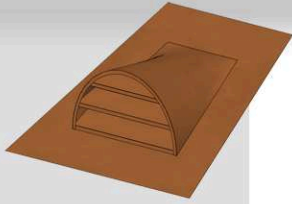

**Peak Top Louvered Dormer Vent**

RM-DPT18 18" wide x 14" high

Detailed dimensions at [tbirdusa.com](http://tbirdusa.com)

- copper
- hammered copper
- stainless 316

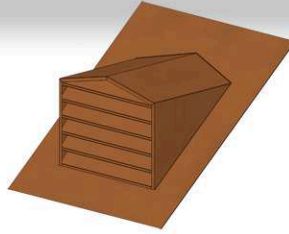

**Rooftop Dryer/Exhaust Vent**

RM-DV4 4" connection  
RM-DV6 6" connection  
RM-DV8 8" connection  
RM-DV10 10" connection

Detailed dimensions at [tbirdusa.com](http://tbirdusa.com)

- copper
- hammered copper
- stainless 316

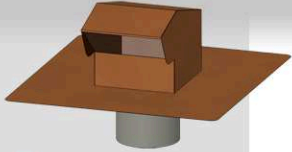

**Low Profile Roof Exhaust Vent**

RM-EV4 4" connection  
RM-EV6 6" connection  
RM-EV8 8" connection  
RM-EV10 10" connection

Detailed dimensions at [tbirdusa.com](http://tbirdusa.com)

- copper
- hammered copper
- stainless 316

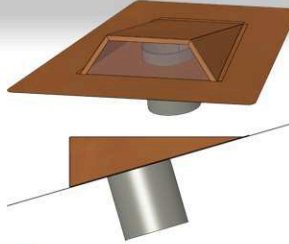

**Low Profile Attic Roof Vent**

RM-LPAV for flat or pitched roofs

Detailed dimensions at [tbirdusa.com](http://tbirdusa.com)

- copper
- hammered copper
- stainless 316

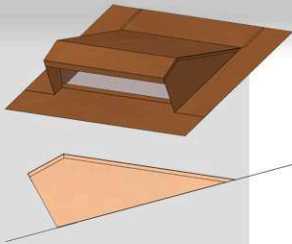

**Rectangular Attic Roof Vent**

RM-RTAV for flat or pitched roofs

Detailed dimensions at [tbirdusa.com](http://tbirdusa.com)

- copper
- hammered copper
- stainless 316

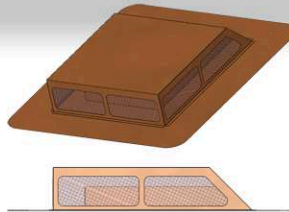

**Standing Seam Vent**

RM-MRV16 for flat or pitched roofs

Detailed dimensions at [tbirdusa.com](http://tbirdusa.com)

- copper
- hammered copper
- stainless 316

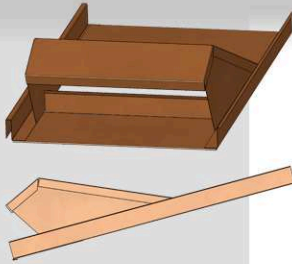

**Copper Gutter Coil**

G-11.875 11-7/8" wide  
G-15 15" wide

Cut to any length.

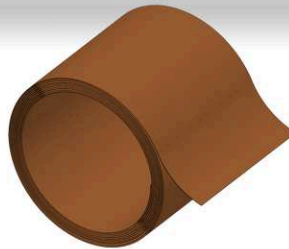

**Post Cap**

Standard and custom sizes.

Made to order.

- copper
- hammered copper
- stainless 316

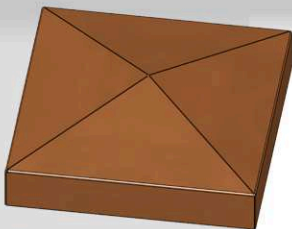

**Copper Nails**

A-NAIL1 1 lb bag  
A-NAIL5 5 lb bag  
A-NAIL50 50 lb box





### Base Flashing

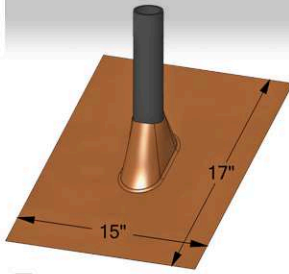

- VBA05 1/2" flashing
- VBA1 1" flashing
- VBA15 1-1/2" flashing
- VBA2 2" flashing
- VBA3 3" flashing
- VBA4 4" flashing

Available as a T-Top.

- copper
- stainless 316
- TPO-clad

### Roof Jack Flashing

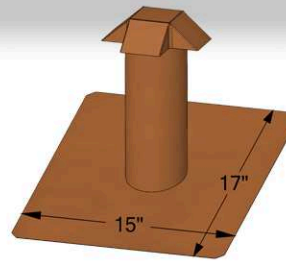

- VRJ3
- VRJ4

for pipe size up to 3"  
for pipe size up to 4"

- copper
- stainless 316

### Vent Stack Flashing

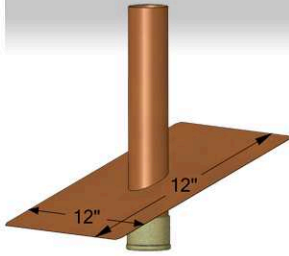

- VS15TA 1-1/2" threaded
- VS2 2" no-hub
- VS3 3" no-hub
- VS4 4" no hub

- copper
- stainless 316

### Solar Panel Mount Flashing

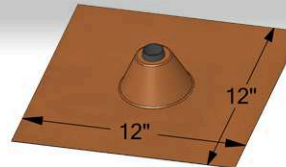

- SF1 1", copper
- S-SF1 1", stainless steel 316
- G-SF1 1", galvanized steel
- B-SF1 1", bonderized steel
- AL-SF1 1", aluminum

Includes EPDM rubber grommet (for 1" size).

Other sizes available (w/o grommet).

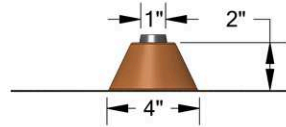

### TPO/PVC T-Top Flashing

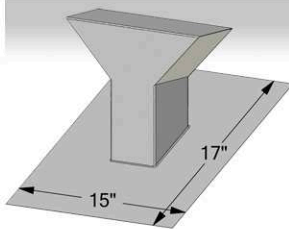

- TPO-TT4 4" t-top
- TPO-TT7 7" t-top

For PVC part # replace TPO with PVC.

### Pitch Pocket Flashing

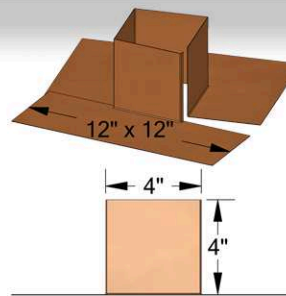

- PP44 4" x 4" flashing
- PP66 6" x 6" flashing

- copper
- galvanized steel

### Edge Metal/Roof Flashing

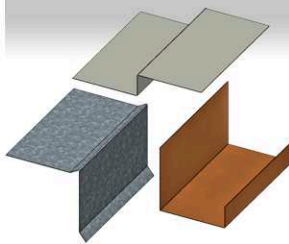

- 10 foot sections in:
- copper
  - stainless steel
  - galvanized steel
  - bonderized steel
  - paintd metal
  - TPO/PVC-clad metal

Standard and custom configurations.

### Stair Flashing

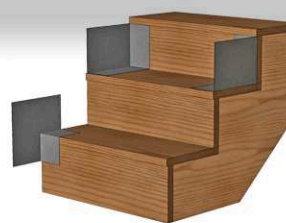

- STICL
- STICR
- STOU

inside left  
inside right  
outside universal

- copper
- bonderized steel

### Door/Window Pan Flashing

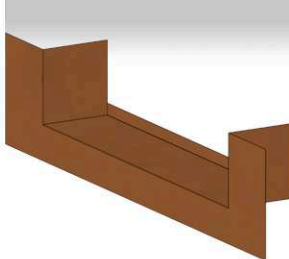

Up to 10 foot long sections in various materials.

Made to order.

### Chimney/Skylight Cricket

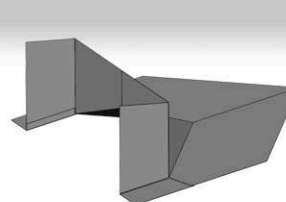

Custom configurations in various materials.

Made to order for any pitch.

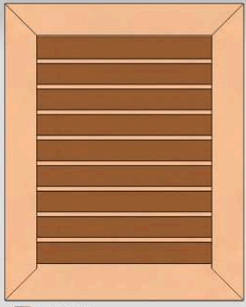

- copper
- hammered copper
- stainless 316

**Louvered Gable Vent**

Flush or Stucco Mount

WLV1212	12" wide x 12" high
WLV1418	14" wide x 18" high
WLV2448	12" wide x 24" high

Other standard sizes available.

Custom sizes made to order.

Detailed dimensions at [tbirdusa.com](http://tbirdusa.com)

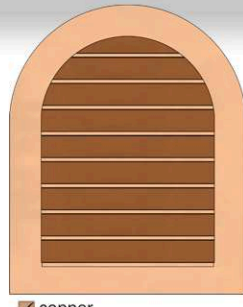

- copper
- hammered copper
- stainless 316

**Tombstone Louvered Gable Vent**

Flush or Stucco Mount

WLVT1218	12" wide x 18" high
WLVT1418	14" wide x 18" high
WLVT2448	12" wide x 24" high

Other standard sizes available.

Custom sizes made to order.

Detailed dimensions at [tbirdusa.com](http://tbirdusa.com)

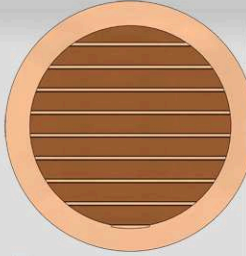

- copper
- hammered copper
- stainless 316

**Round Louvered Gable Vent**

Flush or Stucco Mount

WLVR12	12" round
WLVR18	18" round
WLVR24	24" round

Custom sizes made to order.

Detailed dimensions at [tbirdusa.com](http://tbirdusa.com)



- copper
- hammered copper
- stainless 316

**Foundation/Basement Vent**

Flush or Stucco Mount

WV1405	14" wide x 5" high, flush
WV1608	16" wide x 8" high, flush

Custom sizes made to order.

Detailed dimensions at [tbirdusa.com](http://tbirdusa.com)

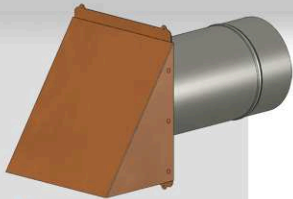

- copper
- hammered copper
- stainless 316

**Dryer/Exhaust Vent**

Flush or Stucco Mount

WDV4	4" connection
WDV6	6" connection
WDV8	8" connection
WDV10	10" connection
WDV12	12" connection

Detailed dimensions at [tbirdusa.com](http://tbirdusa.com)

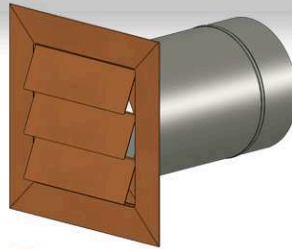

- copper
- hammered copper
- stainless 316

**Low Profile Louvered Dryer/Exhaust Vent**

Flush or Stucco Mount

WLPDV4	4" connection
WLPDV6	6" connection
WLPDV8	8" connection
WLPDV10	10" connection
WLPDV12	12" connection

Detailed dimensions at [tbirdusa.com](http://tbirdusa.com)

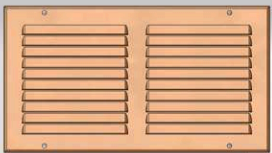

- copper

**Rectangular Vent Grid**

w/ screen

WVGR1106	11-1/8" wide x 6" high
WVGR1606	16-3/8" wide x 6" high

Detailed dimensions at [tbirdusa.com](http://tbirdusa.com)

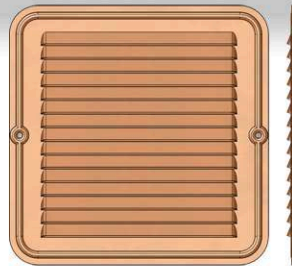

- copper

**Square Vent Grid**

w/ screen

WVGS0505	5" wide x 5" high
WVGS0909	9" wide x 9" high

Detailed dimensions at [tbirdusa.com](http://tbirdusa.com)

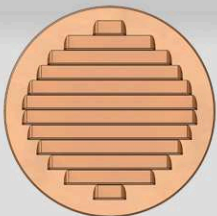

- copper

**Round Soffit Vent**

w/ screen

WSOF1.5	1.5" vent
WSOF2	2" vent
WSOF3	3" vent
WSOF4	4" vent
WSOF5	5" vent
WSOF6	6" vent
WSOF8	8" vent

Detailed dimensions at [tbirdusa.com](http://tbirdusa.com)

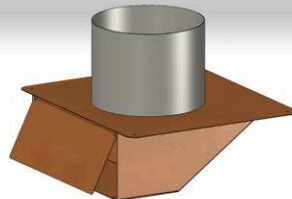

- copper
- hammered copper
- stainless 316

**Under Eave/Soffit Dryer/Exhaust Vent**

WUEDV4	4" connection, dryer
WUEDV6	6" connection, dryer
WUEDV8	8" connection, dryer

WUEEV4	4" connection, exhaust
WUEEV6	6" connection, exhaust

Detailed dimensions at [tbirdusa.com](http://tbirdusa.com)



# LINEAR SHOWER DRAIN

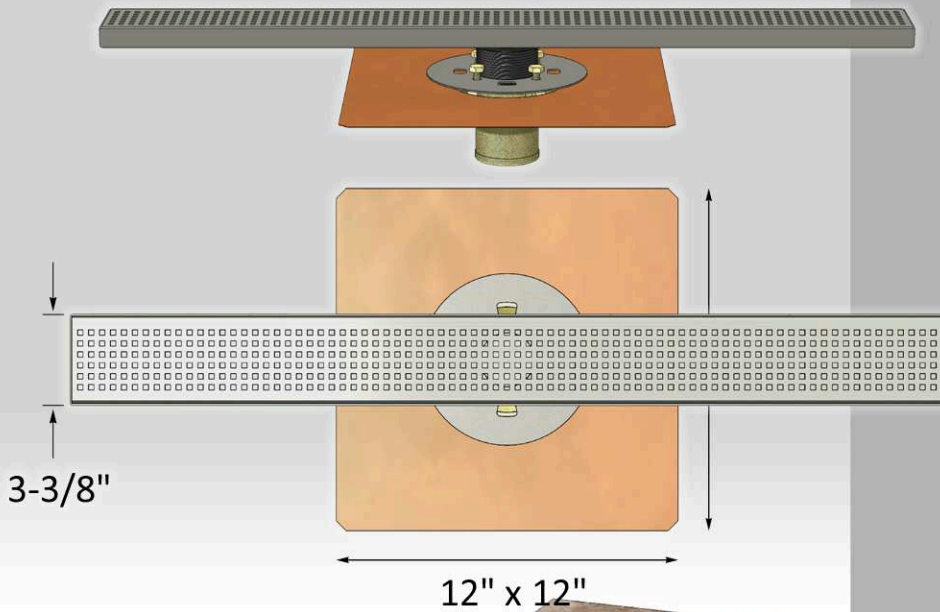

ICC  
ES<sup>®</sup>  
C PMG  
1335

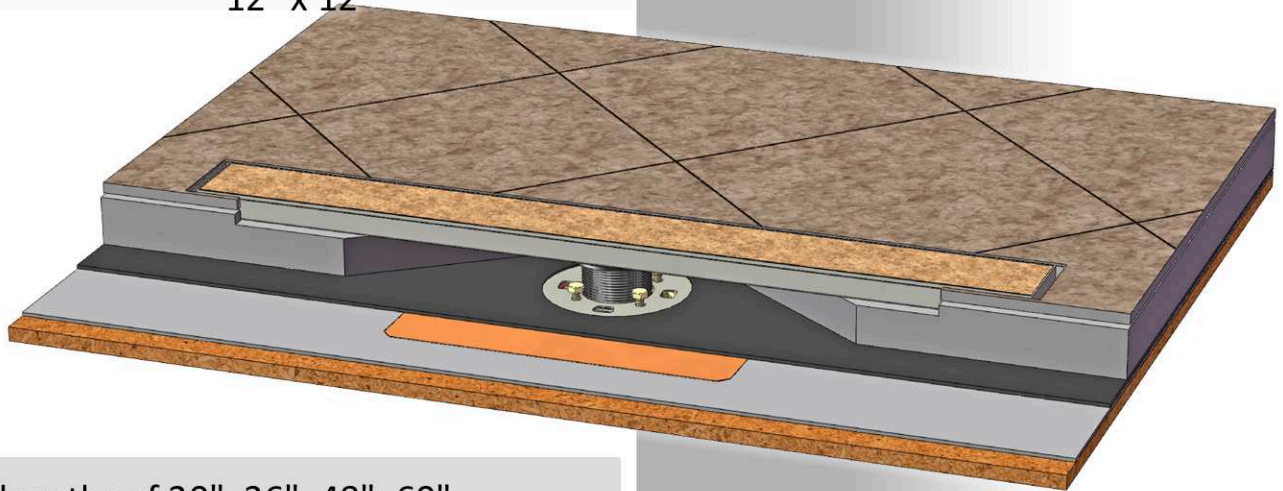

- + Available in lengths of 30", 36", 48", 60"
- + Adjustable height from 1-1/2" to 2-9/16"
- + Copper flashing with stainless clamping ring
- + Drop-in stainless steel grate or tile-in grate
- + 2" or 3" no-hub connection

TBIRDUSA.COM

TEL: (619) 448-3567  
FAX: (619) 448-9072

1148 N MARSHALL AVE.  
EL CAJON, CA 92020

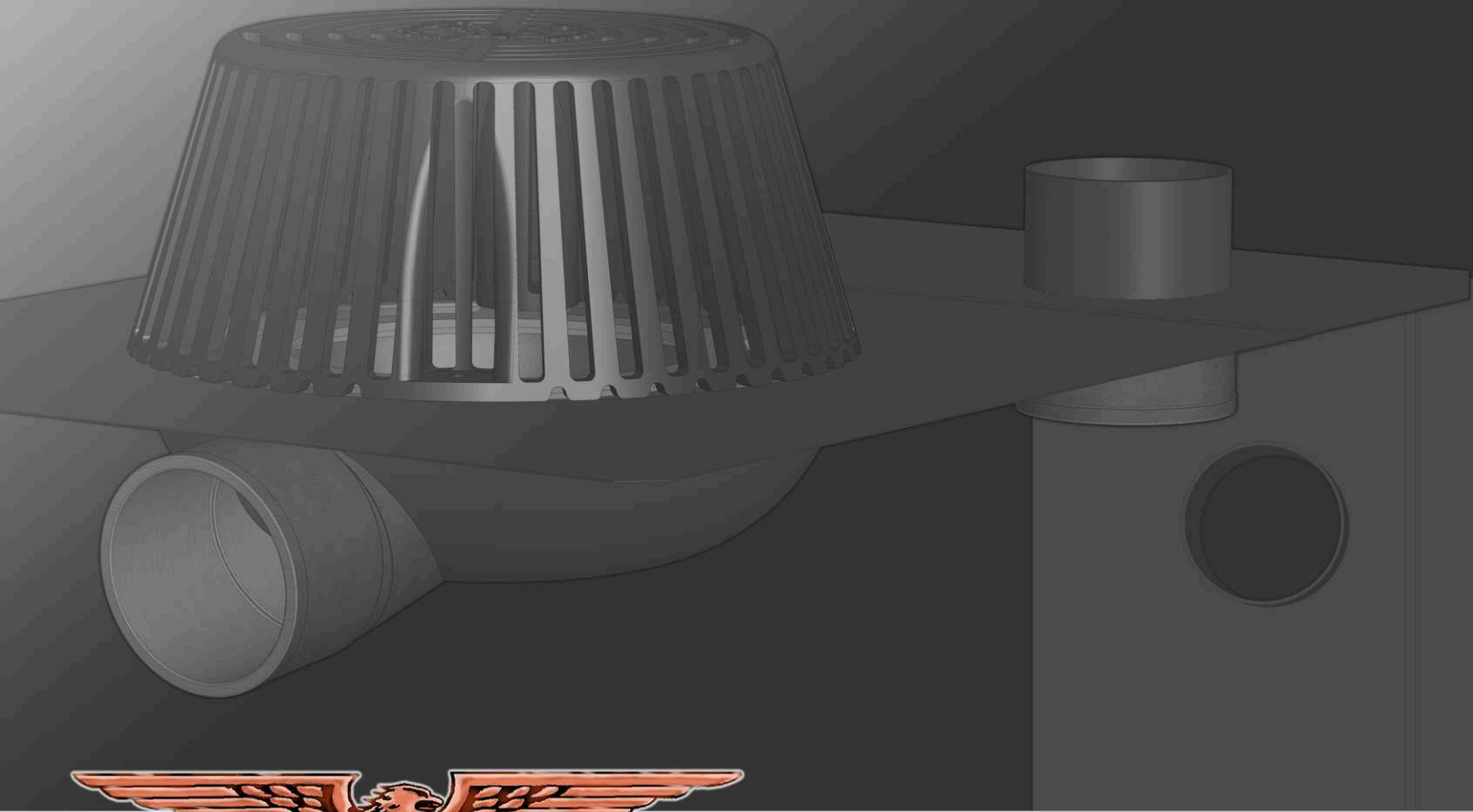

**THUNDERBIRD PRODUCTS**

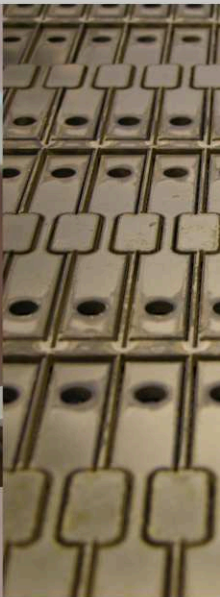



# COMMERCIAL DECK DRAIN

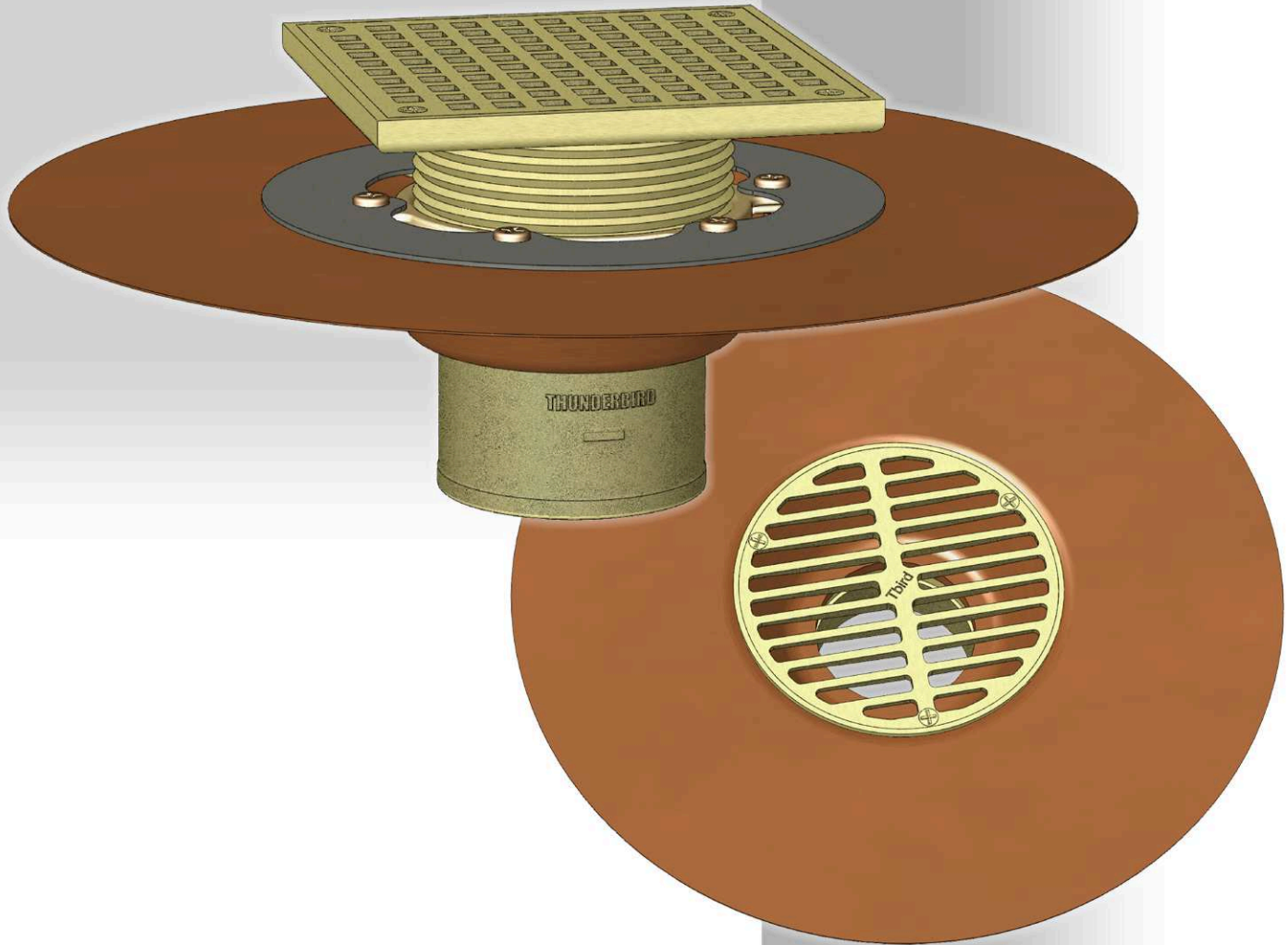

- + 6" adjustable or flush mount grate, 6" bowl
- + spun 14" flashing: 20 oz copper or 24 ga stainless
- + withstands extreme weather conditions
- + optional stainless steel clamping ring
- + 2", 3", or 4" no-hub connection

**TBIRDUSA.COM**

**TEL: (619) 448-3567**

**FAX: (619) 448-9072**

**1148 N MARSHALL AVE.  
EL CAJON, CA 92020**



# SOLAR PANEL MOUNT FLASHING



+ Available in copper, stainless, aluminum, galv steel

+ Standard size for 1" diameter post

+ Low profile height

+ Includes EPDM rubber grommet

+ Custom sizes and configurations available

**TBIRDUSA.COM**

**TEL: (619) 448-3567**

**FAX: (619) 448-9072**

**1148 N MARSHALL AVE.**

**EL CAJON, CA 92020**



# STAIR FLASHINGS

*Reduce your on-site labor!*



In stock: fully soldered stair flashings in bonderized or copper. Our flashings fit all standard stairs. Custom sizes also available.

Inside Left

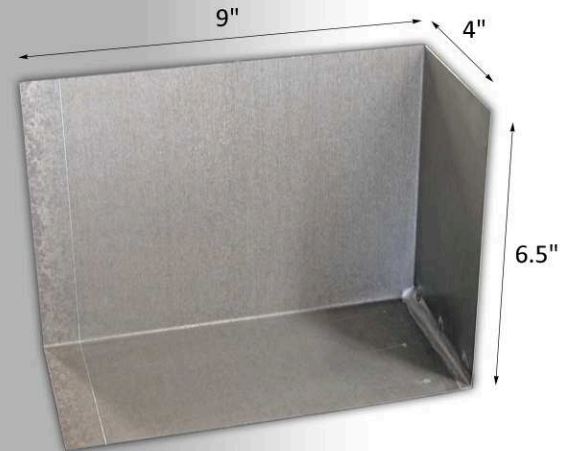

Inside Right

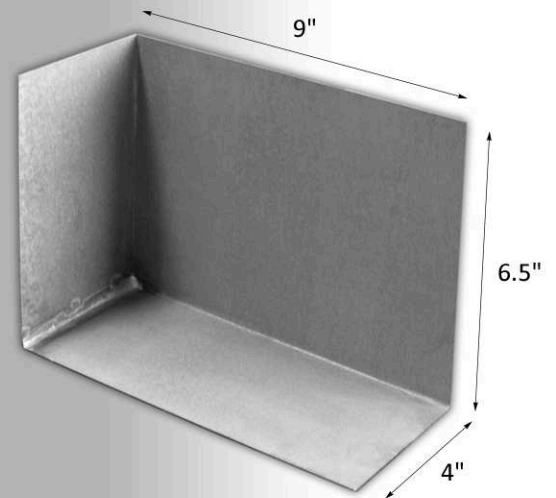

Outside Universal

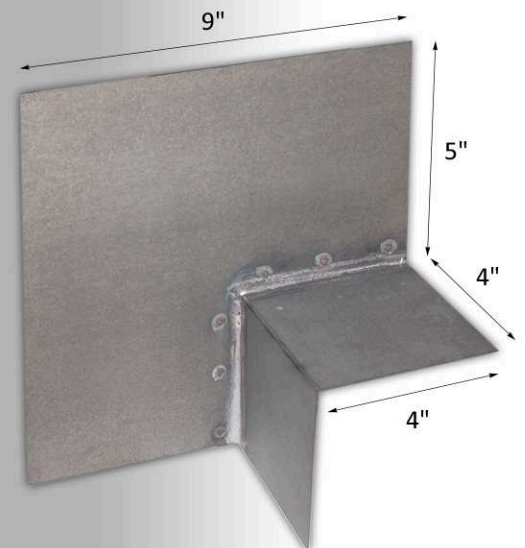



# COPPER GUTTER COIL



Now in stock: 16 ounce copper gutter coils in two sizes, 15" wide or 11-7/8" wide. Sold by the foot or as a roll. Competitive pricing. Call for quote.

[TBIRDUSA.COM](http://TBIRDUSA.COM)

TEL: (619) 448-3567  
FAX: (619) 448-9072

1148 N MARSHALL AVE.  
EL CAJON, CA 92020