



SMART SENSORS

MEASURE MONITOR CONFIGURE PREDICT



**HIGH-RESOLUTION
MEASUREMENT**



TEACHABLE



DUAL OUTPUTS



**PREDICTIVE
MAINTENANCE**

SMART MEASUREMENT SENSORS

- Highly Precise Distance Measurement
- Inductive and Photoelectric
- Digital and Analog Measurement
- Smart Sensor Profile 4.1.1  IO-Link V1.1
-  IO-Link





SMART SENSORS

UNLOCK NEW SENSING POTENTIAL

Contrinex Smart Sensors, designed with the needs of smart factories in mind, have all the answers when it comes to reducing complexity and cost. By implementing multiple sensing modes in a single sensor, Contrinex has given designers the freedom they've always dreamed about, offering exceptional versatility and simplified integration.

Let Contrinex Smart Sensors supercharge your IoT strategy; enjoy all the advantages of the industry-standard IO-Link interface, plus the option of high-speed sensor-based decision-making using SIO. The only limit is your imagination...



Multi-Mode High-Resolution Measurement



Embedded Predictive-Maintenance Features

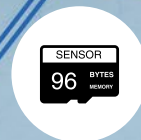

User-Defined Memory

PRODUCT ADVANTAGES SMART INDUCTIVE SENSORS

- ✓ Multiple sensing modes in a single sensor
- ✓ Two sensor output channels enable usage for IIoT applications
- ✓ Extensive options for user configuration ensure exceptional versatility
- ✓ Continual high-resolution DMS Smart Sensors measure distance to sensing targets
- ✓ IO-Link smart profile with analog or digital output simplifies control-system integration
- ✓ Condition-based alarms minimize maintenance costs
- ✓ Full-inox versions offer increased protection with exceptional sensing ranges on aluminum, brass and copper targets

PRODUCT ADVANTAGES SMART PHOTOELECTRIC SENSORS

- ✓ Multiple sensing modes in a single sensor
- ✓ Two sensor output channels enable usage for IIoT applications
- ✓ Extended measurement range vs Smart Inductive Sensors
- ✓ Advanced switching logic encompasses more applications
- ✓ Enhanced triple-mode teach capability for increased flexibility
- ✓ IO-Link smart profile with digital output simplifies control-system integration
- ✓ Condition-based self-monitoring minimizes maintenance costs
- ✓ Localized D2D process logic enables sensor-based decision-making



User-Configurable
Outputs



Direct Device-
to-Device
Communication



Dual Channel

1 POSITION SENSING + UTILIZATION REPORTING

An inductive DMS Smart Sensor, embedded within the spindle of a CNC machining center, senses the position of the spindle drawbar after a tool change, reporting an incomplete engagement via IO-Link to a PLC and triggering an intervention.

The sensor also logs cumulative utilization data for the spindle, reporting at pre-set intervals to a process engineer via a wireless hub and enabling machine optimization to be effected in real time.

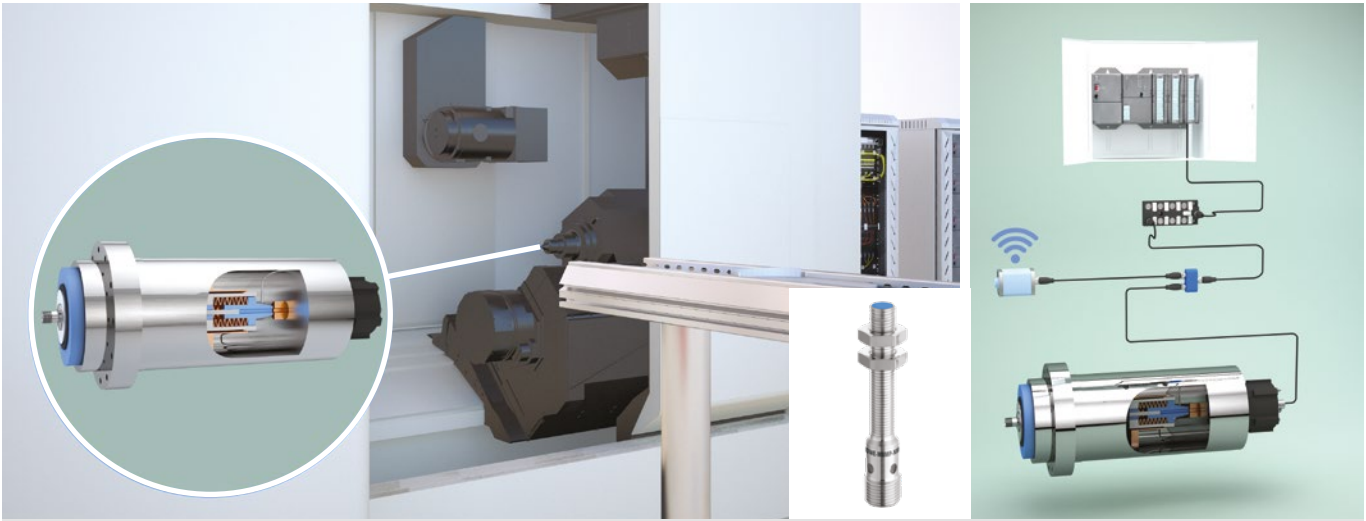

Multi-mode Smart sensor helps maximize productivity and reduce overhead costs

- ✓ Embedded Smart sensor detects incomplete tool engagement in CNC spindle
- ✓ Real-time IO-Link alarm inhibits machine cycle before damage occurs
- ✓ Sensor also reports cumulative utilization data wirelessly to local process engineer
- ✓ Machine optimization to eliminate under-utilization is effected in real time

2 PRESENCE DETECTION + OUTPUT MONITORING

An inductive DMS Smart Sensor, positioned at the end of an output conveyor, detects the presence of a component and reports to the central PLC via IO-Link, triggering a robot to transport the part to the next stage.

The sensor also stores output data, reporting wirelessly to a maintenance technician. Any preventive maintenance or set-up adjustments can be actioned on a use-based schedule, rather than a time-based schedule.



Overall equipment effectiveness (OEE) is maximized at no additional cost

- ✓ Prompt detection of parts at transfer station supports continuous material flow
- ✓ Industry-standard IO-Link interface supports localized decision making
- ✓ Smart Sensor also maintains cumulative production data in background
- ✓ Preventive-maintenance schedule is use-based, rather than time-based

3 DIMENSIONAL MEASUREMENT + STATISTICAL ANALYSIS/REPORTING

An inductive DMS Smart Sensor, mounted immediately above a conveyor, measures a critical dimension on each component as it passes below the sensor, triggering an alarm if an out-of-tolerance condition is detected.

The sensor also logs the cumulative measurement data and calculates the real-time deviation of the mean dimension from the norm. In the event of an unacceptable shift in the deviation, it reports wirelessly to a process engineer so that set-up adjustments can be made before an out-of-tolerance condition arises.

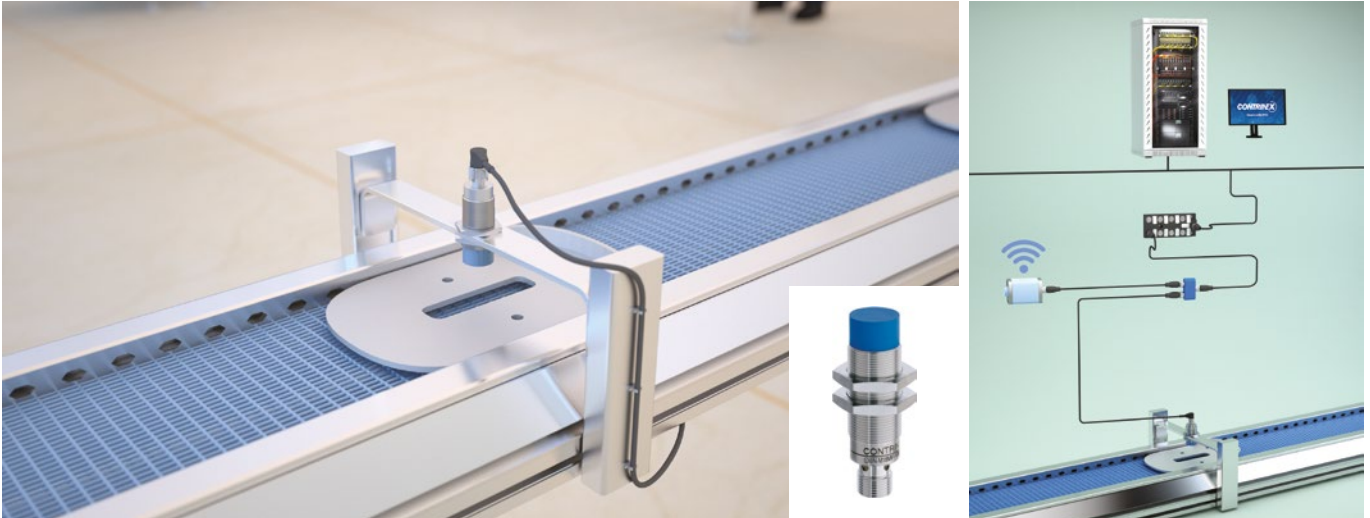

Local process engineers adjust set-up before unacceptable quality costs arise

- ✓ High-resolution DMS Smart sensor measures critical dimension on components
- ✓ Event-based IO-Link signal triggers alarm on detection of out-of-tolerance condition
- ✓ Sensor also collects cumulative measurement data for real-time statistical analysis
- ✓ Any increase of standard deviation from the norm is reported wirelessly

4 OVER- AND UNDER-HEIGHT DETECTION + CONFIGURATION CONTROL

A photoelectric DMS Smart Sensor, positioned above the output conveyor of a PCB reflow oven, detects an over- or under-height condition in a critical area of each PCB, and reports via IO-Link to a PLC, triggering an intervention if required.

The sensor also logs the cumulative throughput of PCBs, and sends an SIO signal directly to the PLC when a pre-set quantity is completed, in turn triggering an upload of a new sensor configuration via IO-Link.

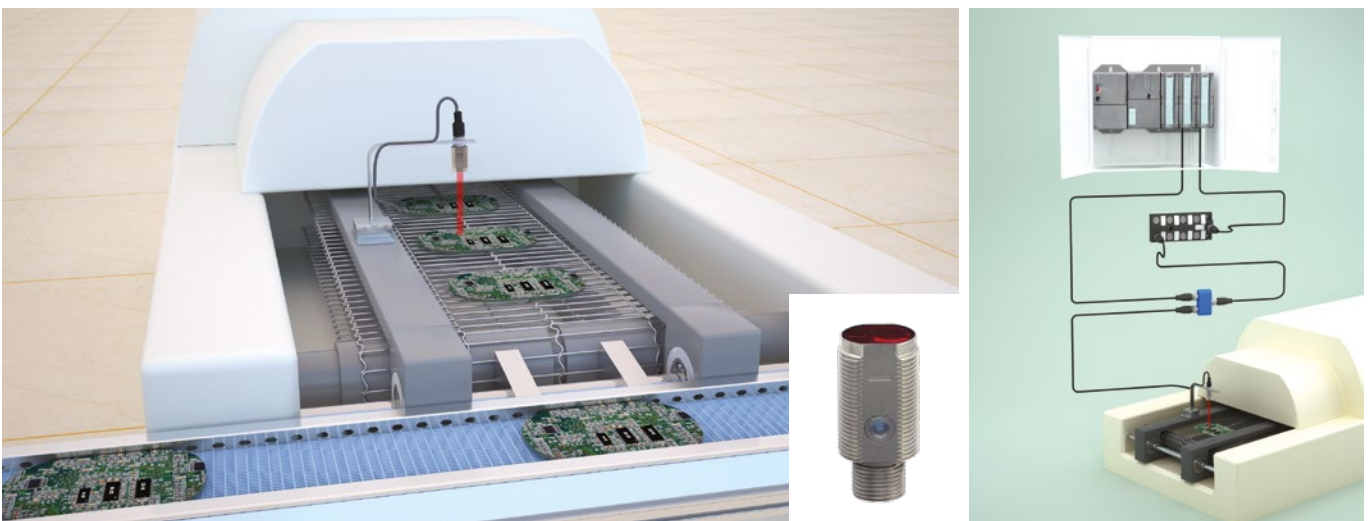

Dynamic set-up changes are not reliant on manual intervention, reducing downtime

- ✓ Non-contact recognition of over- or under-height PCBs eliminates downstream scrap
- ✓ Prompt notification of defective assemblies triggers rapid local intervention
- ✓ Cumulative-throughput data-collection allows sensor to report batch completions
- ✓ Secondary SIO output triggers upload of new sensor configurations via IO-Link

5 THROUGHPUT MONITORING + LOW-UTILIZATION DETECTION

A photoelectric Smart Sensor, located beside a conveyor immediately after shrink-wrapping, monitors carton throughput for stock-control purposes, reporting via IO-Link to a central server.

If a pre-set period of time elapses without a carton being detected, the sensor sends a high-speed SIO signal to a local machine-controller for the next process, triggering a standby condition that reduces energy consumption.

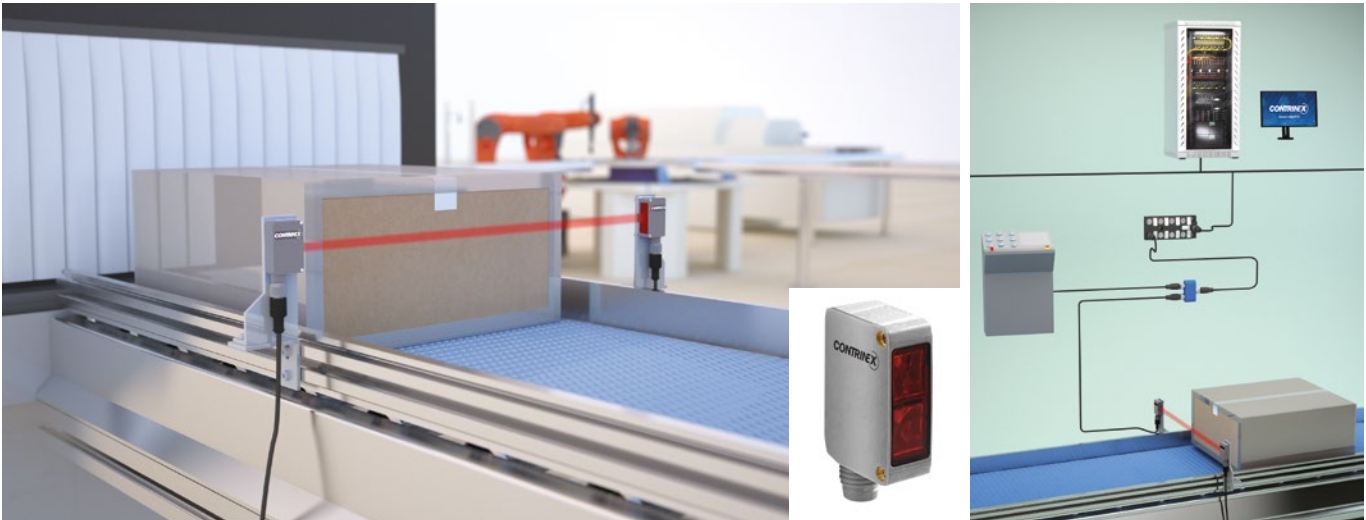

Dual-mode sensor minimizes energy costs during periods of low utilization

- ✓ Smart photoelectric sensor monitors throughput for production-control purposes
- ✓ Regular IO-Link reporting ensures real-time accuracy of inventory-control systems
- ✓ Sensor also detects inactivity by monitoring elapsed time between detections
- ✓ High-speed SIO signal triggers standby mode on inactive equipment, saving energy

6 OVER-HEIGHT DETECTION + THROUGHPUT MONITORING

A photoelectric DMS Smart Sensor, positioned directly above a conveyor transporting sealed cartons, detects an over-height carton and reports via IO-Link to a central server, triggering an intervention if required.

The sensor also maintains a count of throughput, reporting separately when a pre-set quantity is reached and sending an alert to the warehouse in preparation for the arrival of an AGV. This may also trigger an upload of path data to the AGV for its journey to a specific warehouse location.



Smart Sensor enables integration of discrete operational systems

- ✓ Sensor with extended sensing distance ensures non-contact over-height detection
- ✓ IO-Link communication triggers timely intervention if required
- ✓ Smart Sensor also maintains cumulative throughput count at no extra cost
- ✓ Secondary output alerts warehouse systems to expect arrival of an AGV

7 POSITION CONTROL + OVER-TEMPERATURE REPORTING

An embedded DMS inductive Smart Sensor uses inclined-plane principles to sense the precise position of the push-rod in a pneumatic cylinder, halting travel when it is fully extended. Routine process data is transmitted to the PLC via IO-Link.

The sensor also monitors temperature within the cylinder and sends a high-speed SIO alarm signal directly to the PLC if an over-temperature event is detected.

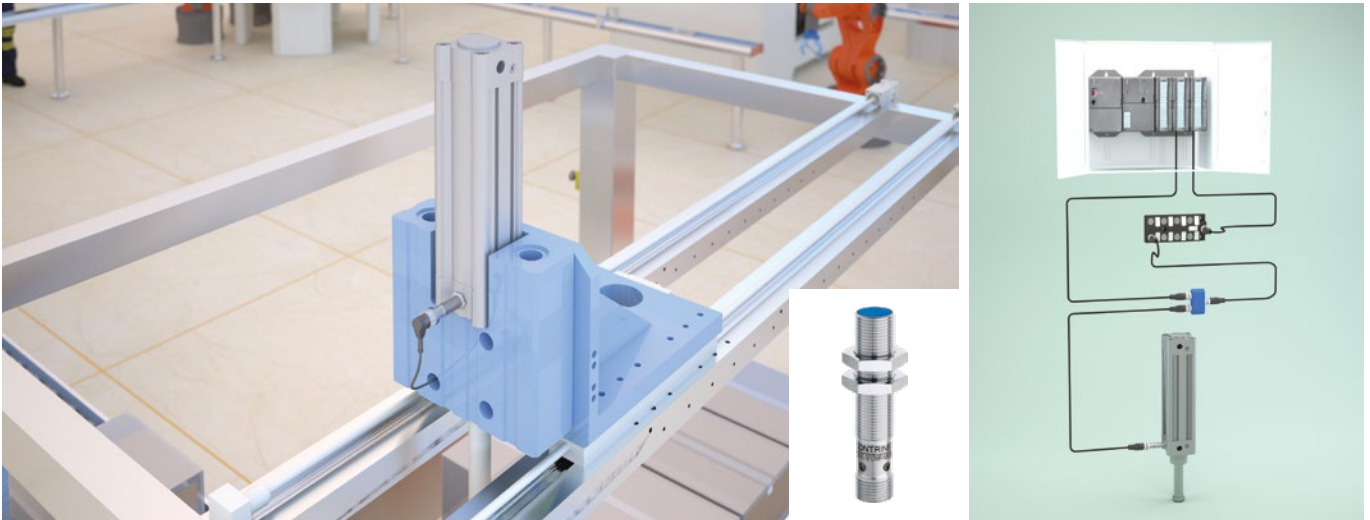

Dual-function sensor ensures productivity is maximized at optimal cost

- ✓ High-resolution position control of pneumatic cylinder ensures accurate placement
- ✓ Real-time process data drives routine machine-position functions
- ✓ Dual-channel operation allows secondary monitoring of cylinder temperature
- ✓ High-speed serial input/output (SIO) triggers rapid action before criticality occurs

8 AGV POSITIONING + MACHINE OPTIMIZATION

An inductive Basic Smart Sensor, positioned in the docking bay of a pick-and-place loading machine, senses the approach of an AGV and communicates via IO-Link with a central PLC, ensuring safe two-speed docking.

Using its second output, the sensor also communicates with a local control system via a wireless hub, initiating start-up for the pick-and-place machine, which has been on stand-by since completion of the previous loading cycle.















Local optimization of machine utilization and energy usage optimizes effectiveness

- ✓ Smart inductive sensor supports two-speed AGV docking to reduce cycle time
- ✓ Simple IO-Link routines trigger low-speed final approach at pre-set distance
- ✓ Secondary output communicates wirelessly with local control systems
- ✓ Machine standby is initiated and ended based on demand, reducing energy needs

SMART INDUCTIVE SENSOR



SMART SENSOR BASIC 	SMART DIGITAL MEASUREMENT SENSORS (DMS) 	SMART ANALOG MEASUREMENT SENSORS (AMS) 
---	--	---

		Operating Distance (mm)		Operating Distance (mm)		Operating Distance (mm)	
M8	emb.	 3	 4	-	-	-	-
	non emb.	-	 6	-	-	-	-
M12	emb.	 4	 6	 6	-	-	-
	non emb.	-	 10	-	-	-	-
P12	emb.	-	 2	-	-	-	-
M18	emb.	 8	 10	 10	-	-	-
	non emb.	-	 20	-	-	-	-

Dual-channel configurable outputs
Stretch, delay or one-shot timers
Digital teach function
Event-based alarms
Temperature monitoring
Counter functions

Dual-channel configurable outputs
Stretch, delay or one-shot timers
Digital teach function
Event-based alarms
High-resolution distance measurement
Linear digital output
Data Storage
Pin 2 configurable as input for wire-teach or D2D
Temperature monitoring
Counter functions

Dual-channel configurable outputs
Stretch, delay or one-shot timers
Digital teach function
Event-based alarms
High-resolution distance measurement
Linear analog or digital output
Voltage output
Data Storage
Temperature monitoring
Counter functions

 **IO-Link**
SSP 2.7 V 1.1

 **IO-Link**
SSP 4.1.1 V 1.1

 **IO-Link**
SSP 4.1.1 V 1.1

Dual Output

Dual Output

Dual Output

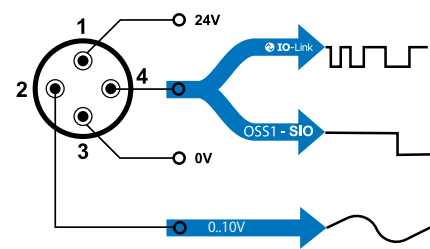
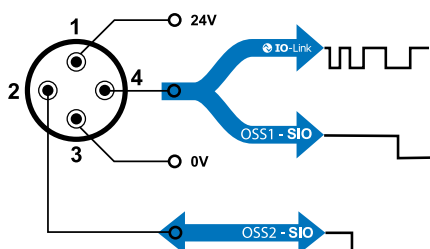
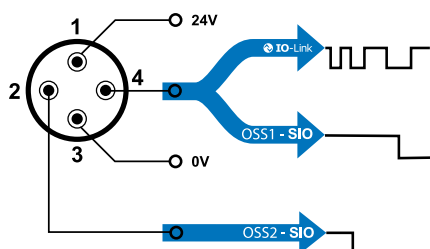

SMART PHOTOELECTRIC SENSOR



SMART SENSOR BASIC



C23	Operating Distance (mm)
Background suppression	0...300
Diffuse	0...1 500
Reflex	0...8 000
Through beam	0...30 000

M18	Operating Distance (mm)
Background suppression	0...250
Diffuse	0...1 200
Reflex	0...7 000
Through beam	0...30 000

- Dual-channel configurable outputs
- Stretch, delay or one-shot timers
- Data storage
- Digital teach function
- Temperature monitoring
- Counter functions
- Event-based alarms



Dual Output

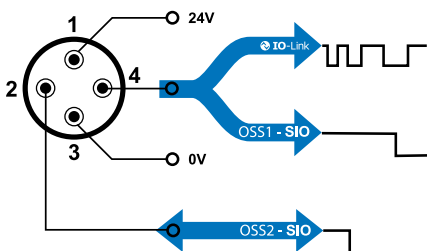

SMART DIGITAL MEASUREMENT SENSORS (DMS)



C23	Operating Distance (mm)
Distance	25 - 150

M18	Operating Distance (mm)
Distance	25 - 150

- Dual-channel configurable outputs
- High-resolution distance measurement with linear digital output
- Stretch, delay or one-shot timers
- Data storage
- Digital teach function
- Pin 2 configurable as input for wire-teach or D2D
- IO-Link smart profile with on-board data storage
- Temperature monitoring
- Counter functions
- Data recording and statistical computation
- Event-based alarms



Dual Output

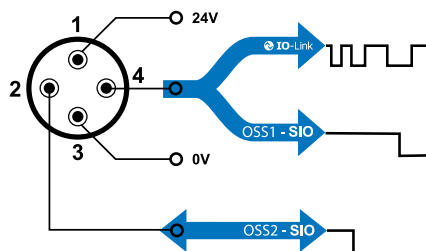

SMART ANALOG MEASUREMENT SENSORS (AMS)



C23	Operating Distance (mm)
Distance	25 - 150

M18	Operating Distance (mm)
Distance	25 - 150

- Dual-channel configurable outputs
- High-resolution distance measurement with linear analog output
- Data storage
- Voltage output
- Stretch, delay or one-shot timers
- Digital teach function
- IO-Link smart profile with on-board data storage
- Temperature monitoring
- Data recording and statistical computation
- Counter functions
- Event-based alarms



Dual Output

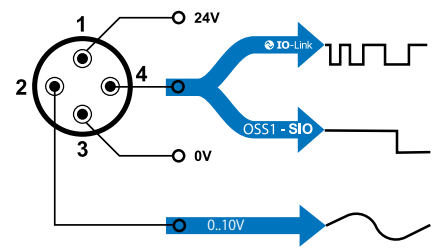

SMART INDUCTIVE SENSOR SEGMENTATION

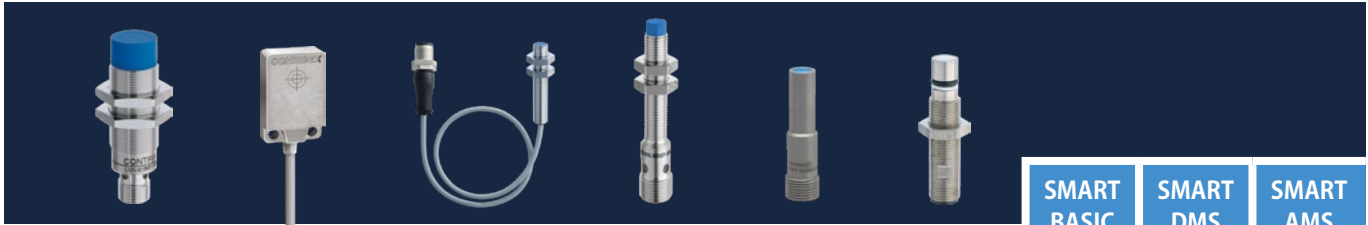

	SMART BASIC	SMART DMS	SMART AMS
Single-channel Output Switching Signal (OSS1) on Pin 4 NO/NC operation via IO-Link or SIO	✓	✓	✓
Boolean process-data variables via IO-Link User-defined thresholds trigger true/false outputs	✓	✓	✓
Event counter User-defined, configurable counter modes	✓	✓	✓
Signal timer Stretch, delay or one-shot timer functions	✓	✓	✓
Temperature monitoring and alarms Real-time or maximum temperature monitoring	✓	✓	✓
Event-based diagnostics Exception reporting, including undervoltage and EMC disturbances	✓	✓	✓
Advanced teach function with configurable switching distances Three teaching modes plus two teachable setpoints	✓	✓	✓
Advanced switching logic Single-point, window and two-point (hysteresis) modes	✓	✓	✓
Configurable alarm source(s) and threshold(s) Alarm triggered on user-defined value of any measured parameter	✓	✓	✓
Assignment of outputs on Pin 4 and Pin 2 fully user-configurable Several variables may be assigned to either OSS1 or OSS2	✓	✓	✓*
Reserved memory space for user-defined data tags Three 32-byte locations for application, function and location tags	✓	✓	✓
Advanced data recording and statistical analysis Configurable histogram of cumulative data values		✓	✓
Calibrated high-resolution distance measurement Highly accurate linear digital output		✓	✓
Pin 2 configurable to accept external input signal Optional SIO input allows teach-by-wire or external trigger signal		✓	
High-resolution linear analog output on Pin 2 Distance measurement with current (4-20 mA) or voltage (0-10 V) output signal			✓

*only on pin 4 (oss1)

SMART PHOTOELECTRIC SENSOR SEGMENTATION

	SMART BASIC	SMART DMS	SMART AMS
Single-channel Output Switching Signal (OSS1) on Pin 4 Light ON/Dark ON operation via IO-Link or SIO	✓	✓	✓
Boolean process-data variables via IO-Link User-defined thresholds trigger true/false outputs	✓	✓	✓
Event counter User-defined, configurable counter modes	✓	✓	✓
Signal timer Stretch, delay or one-shot timer functions	✓	✓	✓
Temperature monitoring and alarm Real-time or maximum temperature monitoring	✓	✓	✓
Event-based diagnostics Exception reporting, including undervoltage and EMC disturbances	✓	✓	✓
User-configurable sensitivity and sequencing Three sensitivity modes plus cross-talk immunity for through-beam variants	✓	✓	✓
Standard teach function via IO-Link Dual-mode teach function with single teachable setpoint	✓	✓	✓
Advanced teach function with configurable switching distances Three teaching modes plus two teachable setpoints	✓	✓	✓
Advanced switching logic Single-point, window and two-point modes	✓	✓	✓
Configurable alarm source(s) and threshold(s) Alarm triggered on user-defined value of any measured parameter	✓	✓	✓
Assignment of outputs on Pin 4 and Pin 2 fully user-configurable Several variables may be assigned to either OSS1 or OSS2	✓	✓	✓*
Reserved memory space for user-defined data tags Three 32-byte locations for application, function and location tags	✓	✓	✓
Advanced data recording and statistical analysis Configurable histogram of cumulative data values		✓	✓
Calibrated and precise distance measurement Highly accurate linear digital output		✓	
Calibrated and precise distance measurement Highly accurate linear analog output			✓
External SIO Input, Wire Teach PIN2 can be used to work with external signals	✓	✓	
Output signal linearization per target type (white/black) Linearization output depending on the target color		✓	✓
User-configurable signal inversion and scaling function Choose domain (window) for signal scaling		✓	✓
Help for the alignment of the light beam Only for through-beam and reflex, via IO-Link, 2 modes	✓		
Working domain configuration For diffuse only, to avoid saturation	✓		

*only on pin 4 (oss1)



PocketCodr

NO-CODE SENSOR CONFIGURATION

- Innovative PocketCodr configurator streamlines configuration and commissioning of Smart Sensors and IO-Link sensors
- PocketCodr app uses live data graphs to present sensor parameters on-screen and in real time
- PocketCodr's unique Action Widgets for Contrinex Smart Sensors guide users through key configuration processes in a code-free environment
- PocketCodr enables remote sharing of sensor configurations among team members, simplifying multi-site collaboration

TEAM COLLABORATION

Let engineers share sensor configurations remotely with technicians and other team members, keeping full control of every process in all factories across the globe.



APPLICATION ENGINEER

- Configure sensors
- Back-up configurations
- Share with team members remotely



PRODUCT OPERATIONS

- Install or replace sensors
- Load shared configurations to sensors
- Digitally teach setpoints and thresholds





LIVE INTERACTIVE DATA GRAPHS

PocketCodr and its multi-functional companion app allow you to interact directly with sensors, presenting real-time parametric changes in-app on live data graphs. Configurable multi-channel monitoring makes it easy to view either routine process data or event-driven changes of state – as and when they occur.

Routines for digitally teaching set-points, setting alarm thresholds or simply viewing process data are simplified; displaying real-time target distance, switching status or time-phased digital output becomes a trivial task. Simply use the Live Data Chart function with your Contrinex Smart Sensor and see exactly how your sensor is behaving – keeping the answers at your fingertips at all times.



USER-FRIENDLY ACTION WIDGETS

PocketCodr's Action Widgets let the user configure compatible Smart Sensors without the need for programming skills.

Tapping a widget icon in the PocketCodr app initiates an easy-to-understand configuration process, stepping through a series of intuitive, graphics-based screens. Users will find themselves at home with familiar controls that include sliders, toggle buttons, and checkboxes, with helpful prompts to guide them through the process. With PocketCodr, you can wave your programming manuals goodbye!



PocketCodr



SMART SENSORS



CONNECTING YOUR POCKETCODR

Ensure your PocketCodr is powered up. Open the PocketCodr app on your mobile device and log in to your account. The app will detect your PocketCodr automatically. Then connect the sensor directly to the PocketCodr using a compatible connecting cable. The sensor details will be displayed in the app and you're ready to configure it.



USE ACTION WIDGETS TO CONFIGURE SETPOINTS AND OUTPUTS



Manual configuration:
Select the desired switching mode – Single-Point, Two-Point or Window.
Enter the desired setpoint value(s) and level of hysteresis. Alternatively tap 'Teach' to configure the setpoint(s).



Teach:
Use the desired teaching procedure – Single-Value, Two-Value or Dynamic.
Position the target at each switchpoint, using the live graph as a guide, then tap "Teach".

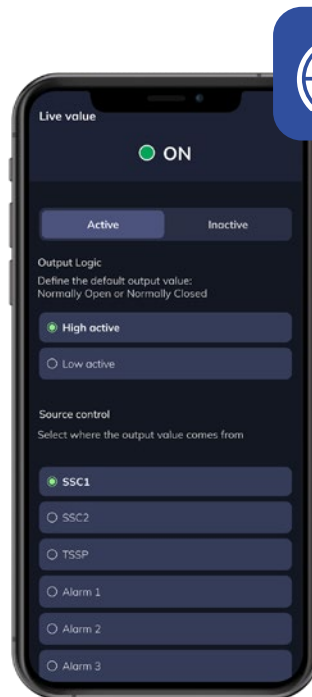

Output(s):
Set output(s) as Active or Inactive and select output logic – High Active or Low Active.
Select the output source – SSC1/2, TSSP or Alarm 1/2/3.

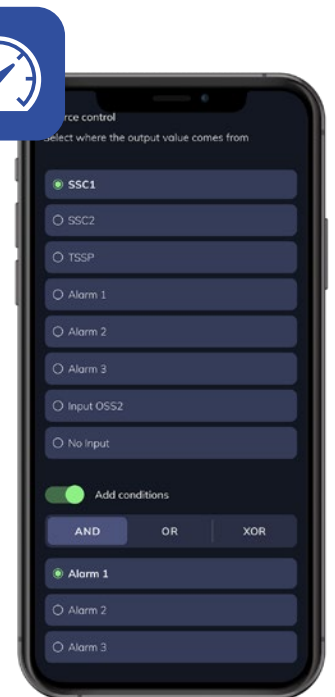

Conditional output logic:
Optionally combine internal signals and alarms and/or an external signal from OSS2 input.
Use AND, OR or XOR functions to define conditional output logic.

CONFIGURING ALARMS, TIMERS AND COUNTERS



Alarms:

Designate multiple alarms as active/inactive. Select the parameter(s) to be monitored
Set alarm threshold(s) and optionally trigger corresponding IO-Link events.

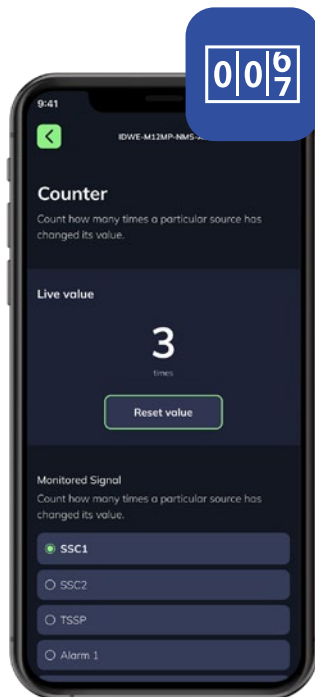

Counter:

Select the internal signal to be counted and designate if counted on the rising or falling edge of the signal.
Display and optionally reset the live count value.
Select the signal to reset the counter.



Timer:

Select the internal signal that triggers the timer.
Set the timer value in milliseconds.
Select the timer mode – Stretch On, Delay On, Delay & Stretch On or One-Shot mode.

SENSOR DATA VISUALIZATION IN REAL-TIME



Monitor live process data in real time.
Display measurement value (Sn) over time in graphic format.
Optionally display multiple Process Data Inputs as digital values.
Select multiple signals, outputs and alarms for display.



SAVING AND SHARING YOUR CONFIGURATIONS



Use the PocketCodr Configuration Library to store and retrieve configurations across your organisation.

Display available configurations and grant user-specific permissions to allow individually tailored upload, retrieval and modification of configurations.

LATERAL DOUBLE-SHEET DETECTION

POCKETCODR MINIMIZES SET-UP COST FOR SMART-SENSOR DOUBLE-SHEET DETECTION

VIEW APPLICATION GUIDE



As global demand for pressed-metal panels in the automotive and other sectors increases, suppliers are under increasing pressure to increase productivity and reduce cost. Using ever-thinner gauges of steel and aluminum, double-sheet errors are harder to detect, heightening the risk of tool damage. Contrinex Smart Sensors sense the presence of individual sheets and also detect unwanted double-sheet conditions, triggering an alarm before damage occurs. During set-up, the innovative PocketCodr sensor configurator simplifies every aspect of configuration via the code-free companion app.

SMART TASKS

- High-resolution digital measurement ensures reliable identification of single- and double-sheet conditions
- User-configured setpoints accommodate multiple sheet thicknesses between batches
- Rapid installation and configuration with PocketCodr no-code sensor configurator
- High-speed notification of time-critical events
- On-board counter function triggers alarm if multiple failure events occur

Self-test function guards against sensor failure

CUSTOMER BENEFITS

- ✓ Robust inductive Smart Sensors eliminate avoidable interruptions to production
- ✓ Early detection of unwanted double-sheet conditions prevents costly tool damage occurring
- ✓ Innovative PocketCodr no-code sensor configurator simplifies configuration and minimizes costs of set-up
- ✓ Individual device configurations are stored locally, allowing plug-and-play replacement of sensors when needed
- ✓ Industry-standard IO-Link connectivity enables quick, easy integration to the machine control system for process data
- ✓ Full-Inox versions with one-piece V2A (AISI 304) stainless-steel housings are available for exceptionally harsh environments

NUT DETECTION

SMART SENSORS AND POCKETCODR COMBINE TO ELIMINATE AVOIDABLE SCRAP COSTS DURING NUT DETECTION

VIEW APPLICATION GUIDE



In assembly operations, defective parts result in costly production scrap. Commonly, manufacturers use weld nuts to provide threaded mounting points in sheet-metal parts, but without robust sensing systems, missing weld nuts go undetected. Contrinex DMS Inductive Smart Sensors confirm the presence or absence of individual nuts in real time, reliably and repeatably. Using the hand-held PocketCodr configurator, configuring sensors for multiple panel variants is simple, requiring no coding expertise and no detailed knowledge of IO-Link.

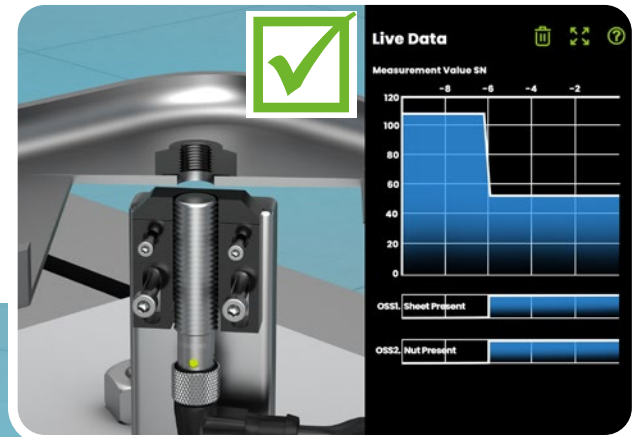

SMART TASKS

- High-resolution digital measurement ensures reliable detection of nut presence or absence
- Cumulative measurement-data log allows statistical analysis and reporting
- In-built counter function supports throughput monitoring, event counting and associated alarms
- Rapid installation and configuration with PocketCodr no-code sensor configurator
- Window switching mode enables workpiece-position monitoring and out-of-range measurement reporting
- User-defined setpoints and alarms allow easy set-up for differing panel sizes and geometries

CUSTOMER BENEFITS

- ✓ Robust DMS inductive Smart Sensors eliminate costly downstream scrap
- ✓ Early detection of incomplete assemblies prevents avoidable interruptions to production
- ✓ Built-in delay and timer functions prevent false positives from triggering the rejection of good parts
- ✓ Innovative PocketCodr no-code sensor configurator simplifies configuration and minimizes costs of set-up
- ✓ Individual device configurations are stored locally, allowing plug-and-play replacement of sensors when needed
- ✓ Industry-standard IO-Link connectivity enables quick, easy integration to the machine control system for process data
- ✓ Full-Inox sensors with one-piece V2A (AISI 304) stainless-steel housings are ideal for harsh environments

HEAVY MACHINERY

REAL-TIME ECCENTRICITY MEASUREMENT DURING STEEL ROLLING OPERATIONS

When bending and forming heavy steel or aluminum plates and strips, monitoring roller deformation and eccentricity is essential to avoid significant scrap costs. Taking machines out of service to inspect rollers causes unacceptable levels of downtime, driving designers to identify real-time solutions. An inductive DMS Smart Sensor from Swiss manufacturer Contrinex deliver actionable information about the condition of a roller, on demand and in real time – including during rolling operations.

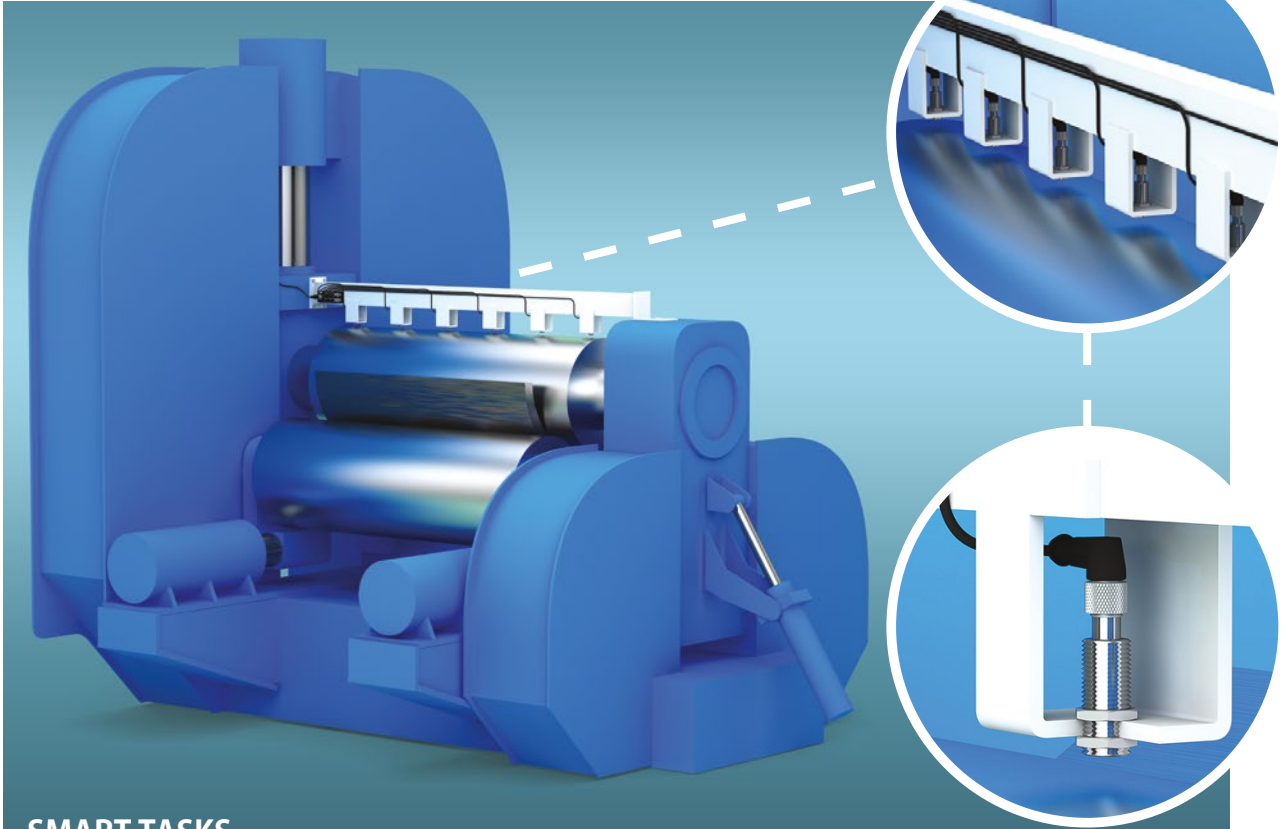

SMART TASKS



- * High-resolution measurement of radial roller displacement
- * Sensor collects cumulative measurement data for real-time statistical analysis



- * Monitors eccentricity, temperature and operational cycle count for maintenance purposes
- * Local storage of sensor configurations, allowing plug-and-play replacement when needed



- * Configurable dual-channel output allows high-speed event-based reporting in background

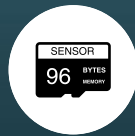

- * Unique embedded sensor ID eliminates installation errors

CUSTOMER BENEFITS

- ✓ Rugged inductive DMS Smart Sensors eliminate downtime, delivering actionable information about roller condition in real time
- ✓ Availability of on-demand data removes time pressure on maintenance teams, making it possible to correct faults before product defects occur
- ✓ V2A (AISI 303) stainless-steel M18 DMS sensors provide a robust, cost-effective solution to the problem
- ✓ Industry-standard IO-Link connectivity enables quick, easy integration to the machine control system for process data
- ✓ Cumulative data, including temperature and operating-cycle count, is recorded in on-board data storage
- ✓ Individual device configurations are stored locally, allowing plug-and-play replacement of sensors when needed
- ✓ The Smart Sensor's dual-channel capability enables a high-speed binary SIO output to be triggered by an event-based exception
- ✓ Proven technology ensures highly reliable fit-and-forget operation with no manual intervention

PNEUMATICS

MULTI-MODE MEASUREMENT OF PISTON DISPLACEMENT AND SPEED

Industrial equipment designers continually seek ways to reduce cycle times without compromising safety or performance, and require a monitoring capability for pneumatic cylinders that identifies deviations from the optimal deceleration profile without increasing complexity or cost. Rugged, multi-mode Smart Sensors from Contrinex, embedded in each cylinder, identify adverse trends in the deceleration profile, providing a cost-effective, unobtrusive fit-and-forget solution.

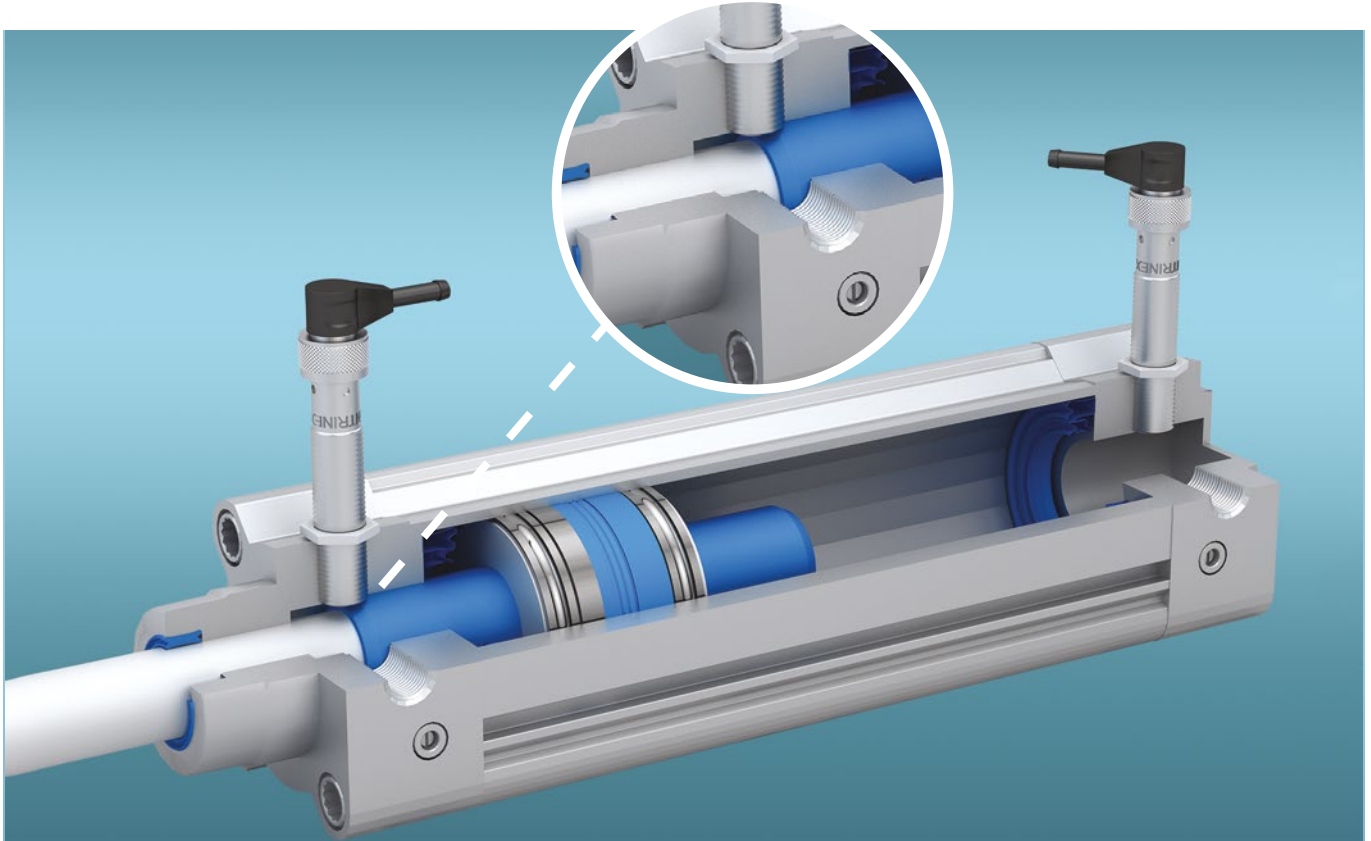

SMART TASKS



- High-resolution measurement of lateral piston displacement
- Repeated high-speed displacement measurement at timed intervals



- Monitor temperature, vibration and process cycle count for maintenance purposes
- Local storage of sensor configurations, allowing plug-and-play replacement when needed



- Generation of velocity gradient using on-board cumulative data store



- High-speed communication with central control system for time-critical events

CUSTOMER BENEFITS

- ✓ Embeddable inductive Smart Sensors offer multiple sensing modes in a single device, eliminating increased complexity and cost
- ✓ One-shot timer feature allows process engineers to identify deviations from the optimal deceleration profile, minimizing maintenance expense
- ✓ Dual-channel capability enables a local alarm to be triggered by an event-based exception, avoiding a plant-wide shut-down
- ✓ Industry-standard IO-Link connectivity provides a single interface to the machine control system
- ✓ Cumulative operating data for predictive maintenance, including temperature and operating-cycle count, is recorded in on-board data storage
- ✓ Sensor configurations are stored locally, allowing plug-and-play replacement of sensors when needed
- ✓ Proven technology ensures highly reliable fit-and-forget operation with no manual intervention

LINEAR GUIDE

PERFECT LOCATION AND POSITIONING OF LINEAR STAGE

Automation engineers designing high-speed assembly equipment with multiple linear transfers between workstations need to maximize speed and accuracy while keeping cost down. They require a single-sensor positional-control solution that delivers a high-speed approach to the critical areas and a slower, high-precision final positioning. An inductive Smart Sensor from Contrinex with IO-Link connectivity and multiple user-configurable outputs performs both the required tasks in a highly cost-effective manner.

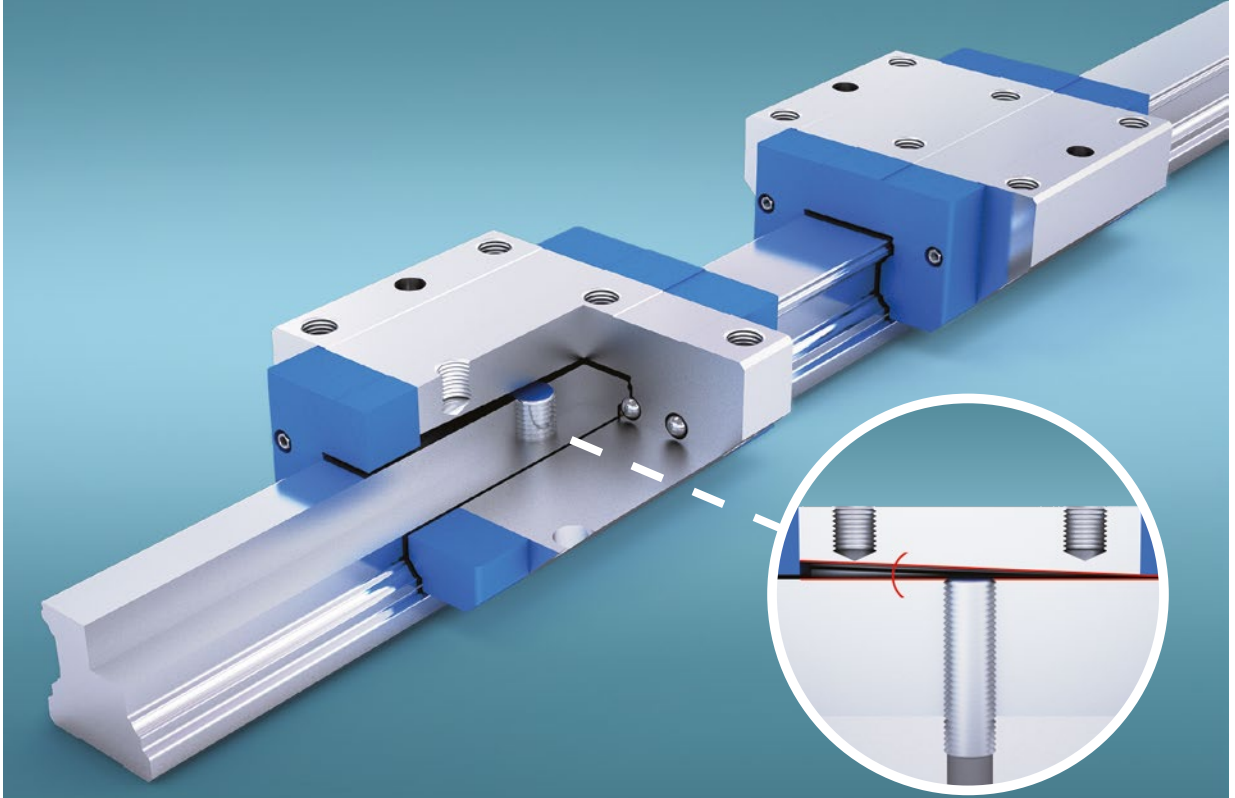

SMART TASKS



- Reliable position sensing on high-speed approach
- High-accuracy lateral position measurement during final stage positioning



- User-configured setpoints ensure precise window-mode positioning



- IO-Link smart profile simplifies control-system integration



- Sensor configuration is backed-up automatically on the local IO-Link Master

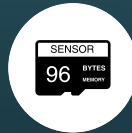

- Unique embedded sensor ID eliminates installation errors

CUSTOMER BENEFITS

- ✓ Rugged inductive Smart Sensors ensure accurate positioning of linear stages without compromising operational speed
- ✓ Single-sensor positional-control system is non-complex and highly affordable
- ✓ Compact embeddable M12 sensors fit unobtrusively and easily into off-the-shelf linear guide rails
- ✓ Industry-standard IO-Link connectivity provides a single interface to the machine control system
- ✓ Sensor configurations are stored locally, allowing plug-and-play replacement of sensors when needed
- ✓ Proven technology ensures highly reliable fit-and-forget operation with no manual intervention



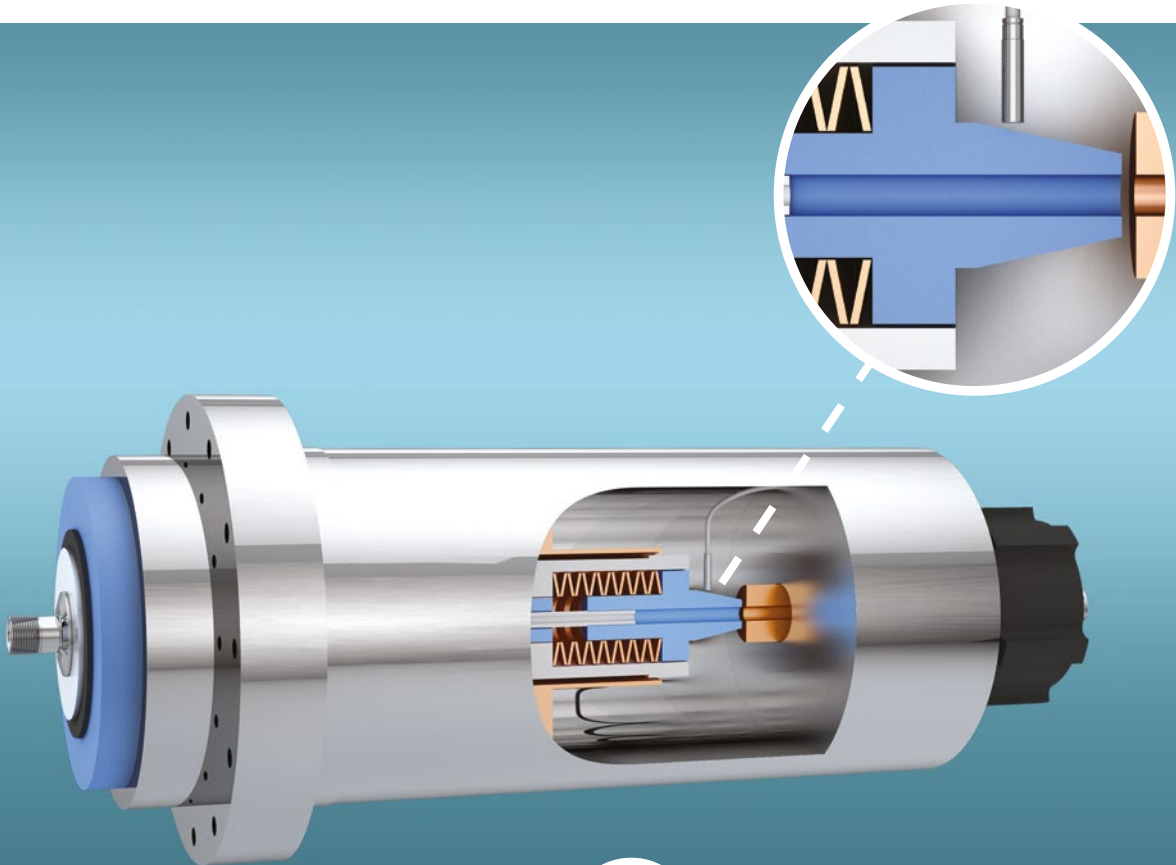

SPINDLE

CHECKING TOOL PRESENCE AND POSITION IN A CONFINED SPACE

Modern CNC machining centers cope with ranges of materials, workpieces and cutting speeds that require different tool characteristics; spindles with automatic tool-changing are key to optimizing throughput. If a new tool fails to engage completely, damage to the tool, the workpiece or the spindle results. Smart Sensors from Contrinex, embedded in the body of the spindle, monitor the position of the drawbar during changes; any non-compliant measurements stop the process, triggering an alarm.



SMART TASKS

-  Precision real-time measurement of drawbar position
-  User-configured setpoints ensure accurate end-of-travel position sensing
-  High-speed notification of time-critical events
-  Threshold alarms identify over-temperature and end of service life
Sensor configuration is backed-up automatically on the local IO-Link Master
-  Self-test function guards against sensor failure

CUSTOMER BENEFITS





- ✓ Embeddable inductive Smart Sensor monitors drawbar position, detecting incomplete tool engagement and inhibiting further motion before damage occurs
- ✓ Single-sensor positional-control system is non-complex and highly affordable
- ✓ Embeddable M12 sensor fits snugly in the limited space available
- ✓ Industry-standard IO-Link connectivity provides a single interface to the machine control system
- ✓ Cumulative operating data for predictive maintenance, including temperature and operating-cycle count, is recorded in on-board data storage
- ✓ Sensor configurations are stored locally, allowing plug-and-play replacement of sensors when needed
- ✓ Proven technology ensures highly reliable fit-and-forget operation with no manual intervention.

RECYCLING

RELIABLE DETECTION OF DIFFERENT METALLIC MATERIALS

The global recycling industry continually seeks to reduce the cost of sorting and separating mixed-metal scrap. With the introduction of induction sorting, designers require sensors that operate accurately and at high speed to identify and separate fast-moving streams of ferrous and non-ferrous material in a single pass. Rugged inductive Smart Sensors from Contrinex, embedded immediately below the delivery belt, provide continuous high-speed detection across the full width of a conveyor.

SMART TASKS

- 
 - Multi-mode target recognition at constant target distance
- 
 - Unique embedded sensor ID eliminates installation error
- 
 - High-speed localized communication with air-knife actuators
- 
 - Cumulative cycle/target counting in each of two modes
 - Threshold alarms identify over-temperature and end of service life
 - Sensor configuration is backed-up automatically on the local IO-Link Master

CUSTOMER BENEFITS

- ✓ Embeddable inductive Smart Sensors detect ferrous and non-ferrous metal and trigger separation accurately and reliably
- ✓ A single array of sensors provides continuous detection across the full width of a conveyor
- ✓ Smart Sensors are easily able to identify material on fast-moving conveyors
- ✓ Industry-standard IO-Link connectivity provides a single interface to the machine control system
- ✓ Cumulative operating data for predictive maintenance, including temperature and operating-cycle count, is recorded in on-board data storage
- ✓ Sensor configurations are stored locally, allowing plug-and-play replacement of sensors when needed
- ✓ Proven technology ensures highly reliable fit-and-forget operation with no manual intervention



SECTION
/N 212793

LOCATION ZONE
710
SUZZONE - LANDING GEAR

CEC 9313

SYSTEM NO	SENSOR NO	LOCATION
1	5848	LEFT
2	7845	RIGHT

MANUALS

Production Capacity: 400/day
Uptime: 99%
Energy State: Active
Pressure: 42/3
Auto Errors: 0

CONNECTED

LOCATION

ONLINE-LAB-359

- BRASS PIVOT HING (M)
- OHM METER (M)
- 12 VOLT TEST BATTERY (M)
- 1.25" PVC ELBOW (M)
- 1.5" ACCH (M)

MAXData

CONTROLLER TYPE: PLC
SENSOR NAME: INDUCTIVE
SENSOR: 1000000000
LAST ERROR CALL: 4/10/2023 10:00 AM

74%
99%

- RULES**
- Enable automation using supporting systems
 - Report critical safety conditions immediately
 - Use appropriate PPE when working in this area to lift
 - Remember to lock, tag, and ground
 - Stay out of safety area, unless you are operating the machines

8/N 212793

Diagram

3

2

Errors in the past weeks



MULTI-MODE HIGH-RESOLUTION MEASUREMENT

✓ **Multiple sensing modes in a single sensor**

DIRECT AND INDIRECT MEASUREMENT

By adopting both direct and indirect measurement techniques, Contrinex has implemented multiple sensing modes in a single Smart Sensor. Depending on the user-defined mode of operation, measurements may be output as either process data (routine, cyclical parametric values) or event data (exceptions generated on the occurrence of a critical event).

Using the Smart Sensor's underlying capability for high-resolution distance measurement, direct measurements include axial distance (1) and lateral position (2). The sensor's exceptional sensitivity also allows it to detect non-uniform features (for example, holes) present in a target (4).

Other physical properties whose application can be translated into a displacement are also suitable for Smart Sensing. Non-contact examples include: continuous angular measurement using a cam mounted on a rotating shaft (3), lateral position measurements of larger targets using an inclined plane surface on the target (5), force measurement using a transfer element that deforms elastically (6), as well as vibration measurement (amplitude and frequency) in the axial direction (7).

Step counting – either linear or rotational (8) – is another proven application for Smart Sensors. The sensitivity of these devices allows them to replace traditional encoders, which are often bulkier and more costly.

1. Distance measurement

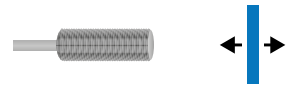

2. Lateral position measurement (constant distance)

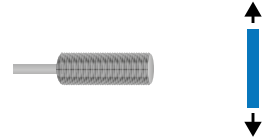

3. Angular measurement

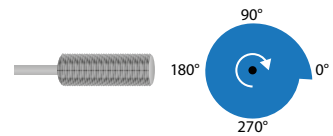

4. Feature detection

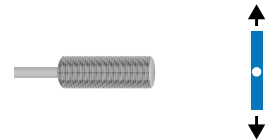

5. Lateral position measurement (inclined plane)

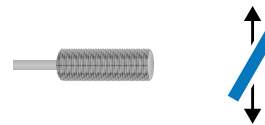

6. Force measurement

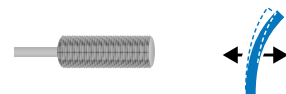

7. Vibration measurement

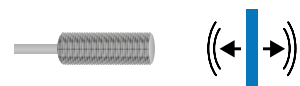

8. Step counting

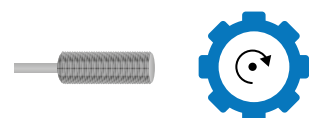

SMART FEATURES



USER CONFIGURABLE OUTPUTS

✓ Exceptional versatility optimizes spares inventory

SWITCHING SIGNAL CHANNELS (SSC)

The Smart Sensor's internal signals are referred to as Switching Signal Channels (SSC); the external input and output signals that result from an SSC are designated Output Switching Signals (OSS). By default, a Smart Sensor has a single-point threshold SSC enabled on Pin 4 (OSS1) of its connector, which operates in either IO-Link mode or Standard-IO (SIO) mode. On power-up, a Smart Sensor defaults to SIO mode; once the sensor is connected to an IO-Link master, a "wake-up" pulse from the master switches it to IO-Link mode. Thereafter, bidirectional communication operates between the master and the sensor.

PIN ASSIGNMENT

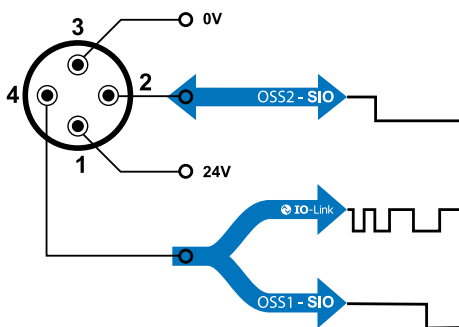

A second SSC may optionally be configured on Pin 2 (OSS2) of the Smart Sensor connector. If enabled, SSC2 operates solely in SIO mode and may be designated as an input or an output channel. The presence of a second IO channel gives integrators access to powerful additional features of the Smart Sensor, including Device-to-Device communication, Teach functions and Built-in Test functions.

DYNAMIC SWITCHING LOGIC

When specifying Contrinex Smart Sensors, designers assign their chosen switching logic to any of the available sensing modes – either as a one-time choice at the time of installation, or dynamically as the equipment operating sequence dictates. A single sensor provides all the options needed to monitor multiple parameters, with the flexibility to make real-time changes over IO-Link or via the built-in Teach function.

SINGLE-POINT MODE

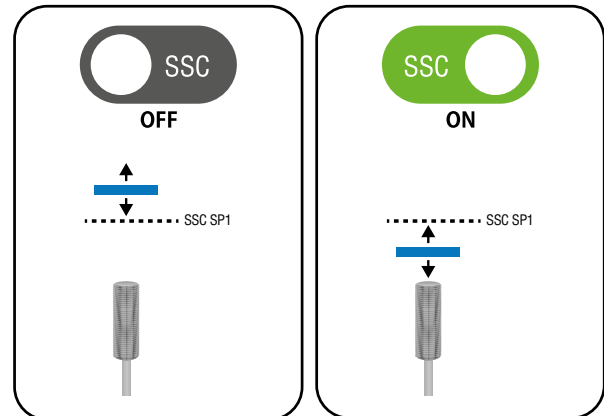

With single-point mode selected, Smart Sensors behave as conventional two-state devices. The default logic (which may be inverted if the application requires it) sets the switching signal to "high" (SSC ON), if a threshold level or setpoint (target sensing distance, for example) has been reached. Either side of the switching point, the signal simply switches between "high" and "low" accordingly.

WINDOW MODE

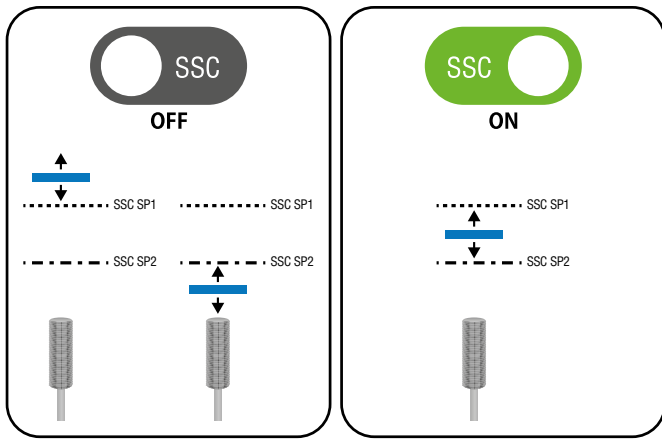

Window mode allows designers to monitor a range of values, which may be defined by two discrete switching setpoints. As the example shows, the default logic sets the switching signal to “high” (SSC ON) if the measured value lies between the two setpoints. In all other cases, once the measured value moves outside the defined range, the switching signal is set to “low”.

TWO-POINT (HYSTERESIS) MODE

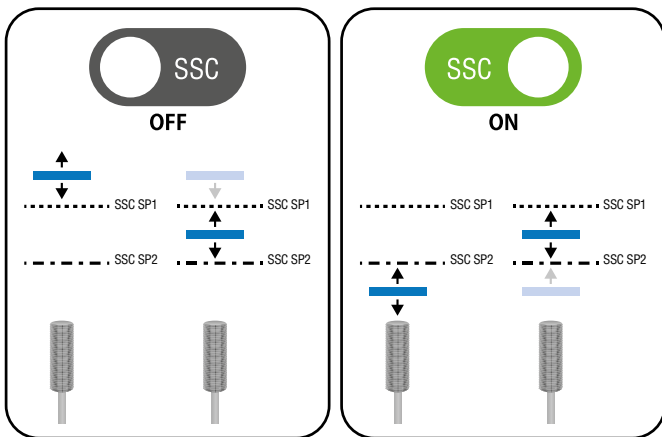

Two-point (hysteresis) mode showcases the Smart Sensor’s ability to respond to setpoints or threshold values that trigger a change in the SSC only when the measured value is moving in a specified direction (rising or falling). In the example shown, as the measured value falls and passes SP1, the SSC remains set to “low” (SSC OFF). Only when the measured value reaches SP2 is the SSC set to “high”. As the measured value rises again, passing SP2 has no effect on the SSC, which is only set to “low” once the measured value reaches SP1 again.

TIMING MODES

Modifying the timing of a change in the SSC allows designers to nullify the effect of common process events that give rise to false triggers. Such events include (i) momentary changes in measurement value for non-process-related reasons and (ii) momentary loss of signal for known reasons.

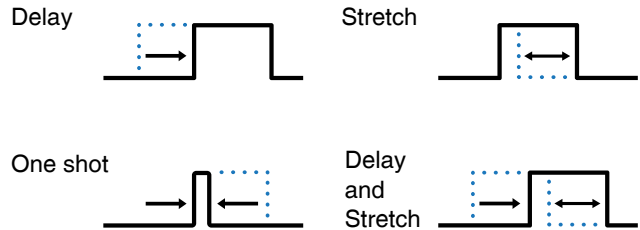

DELAY

Introducing a specified delay before changing the status of the OSS in either direction prevents the sensor responding to a short-duration change in measurement value for reasons that include localized variability in the environment. Adopting a switching delay also helps prevent signal “bounce”, where the transition from one state to another may not be clearly defined. Delay may optionally be combined with stretch (see below).

STRETCH

Stretching the OSS output pulse ensures that the signal has a minimum duration – often desirable for control purposes or to compensate for a measurement value that varies non-linearly over time. For example, communication with a “slow” PLC may require a minimum-duration pulse to ensure proper synchronization. Similarly, in the absence of a minimum-duration pulse, a measurement value that is not clearly defined during the transition from one state to another might otherwise give rise to multiple false triggers.

ONE-SHOT MODE

Smart Sensors also have the capability to generate a “one-shot” pulse on either the leading edge or the trailing edge of a change in the measurement value. One-shot pulses, also known as “differential up” and “differential down” may be required for secondary control functions that are implemented in a connected PLC.

SMART FEATURES

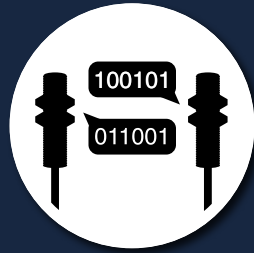

DIRECT DEVICE-TO-DEVICE COMMUNICATION

- ✓ Localized D2D process logic enables sensor-based decision-making

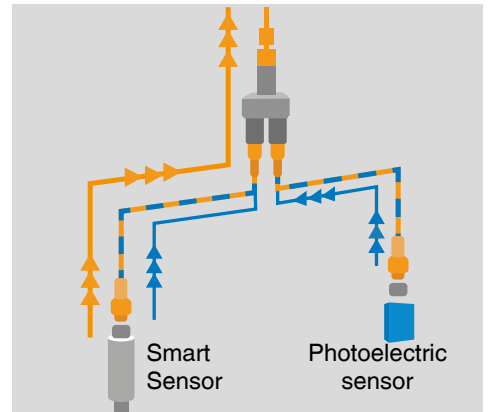

BOOLEAN LOGIC

Designating a second SSC as an input channel allows designers to implement Boolean logic by combining an internal switching signal of the Smart Sensor (SSC1) together with that of a second two-state sensor (OSS2) operating in SIO mode. In the example shown, the Smart Sensor monitors the presence of an aluminum-foil closure on a bottle, while the secondary photoelectric sensor checks the fill level.

BOOLEAN AND (SENSOR ENABLE/DISABLE ON PIN 2)

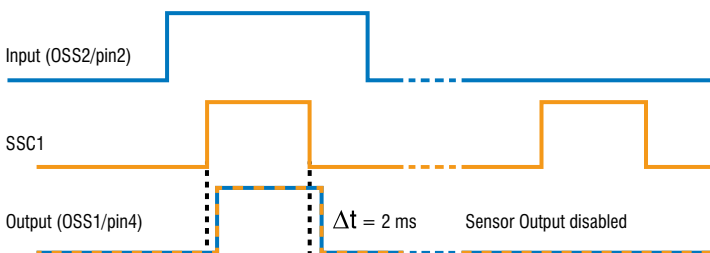

BOOLEAN "AND"

Operating in Boolean "AND" mode, the signal from the secondary sensor is used to enable or disable the Smart Sensor, resulting in the Smart Sensor output (OSS1) being set to "high" only when both sensors are triggered. The output signal on OSS1 is delayed by two milliseconds.

BOOLEAN OR (SENSOR BYPASS ON PIN 2)

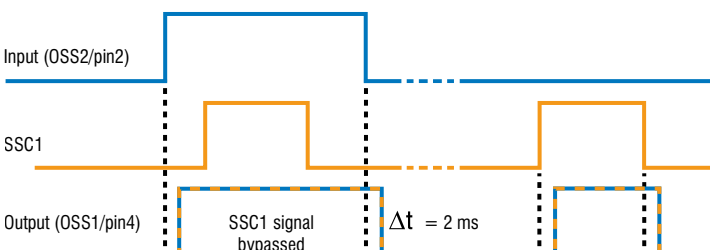

BOOLEAN "OR"

Alternatively, when a Boolean "OR" function is required, a "high" signal from the secondary sensor is set to bypass the Smart Sensor signal, overwriting the SSC1 output. The Smart Sensor otherwise continues to operate normally, and consequently, its output (OSS1) is set to "high" when either sensor is triggered. Again, a two-millisecond delay is introduced.

BUILT-IN TEST (BITE) FUNCTION

The SSC2 input channel serves an additional purpose when a self-test function is required. A BITE signal on SSC2 from a connected PLC or microcontroller is used (i) to determine whether the Smart Sensor is functioning correctly and (ii) to establish the presence or absence of a target.

A BITE handshake pulse returned by the sensor confirms its working state, while the polarity of the pulse indicates the presence or absence of a target. Failure by the sensor to return a handshake pulse signifies a defective device.

BOOLEAN XOR (BITE FUNCTION ON PIN 2)

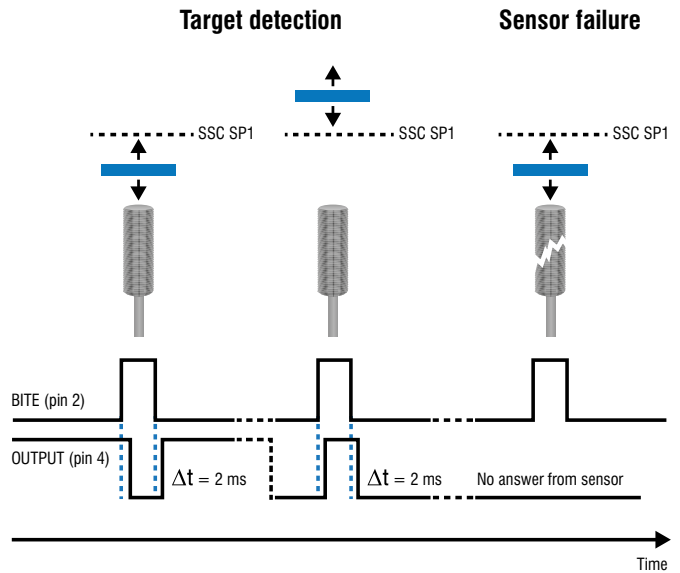

TEACH FUNCTION

Teaching the sensor externally to recognize one or more setpoints is another D2D function. Smart Sensors are supplied with default (factory-set) values for SP1 and SP2; during commissioning, engineers use either a locally connected teach device or a remote PLC to communicate with the Smart Sensor via OSS2.

EXTERNAL TEACH (HIGH/LOW SIGNAL ON PIN 2)

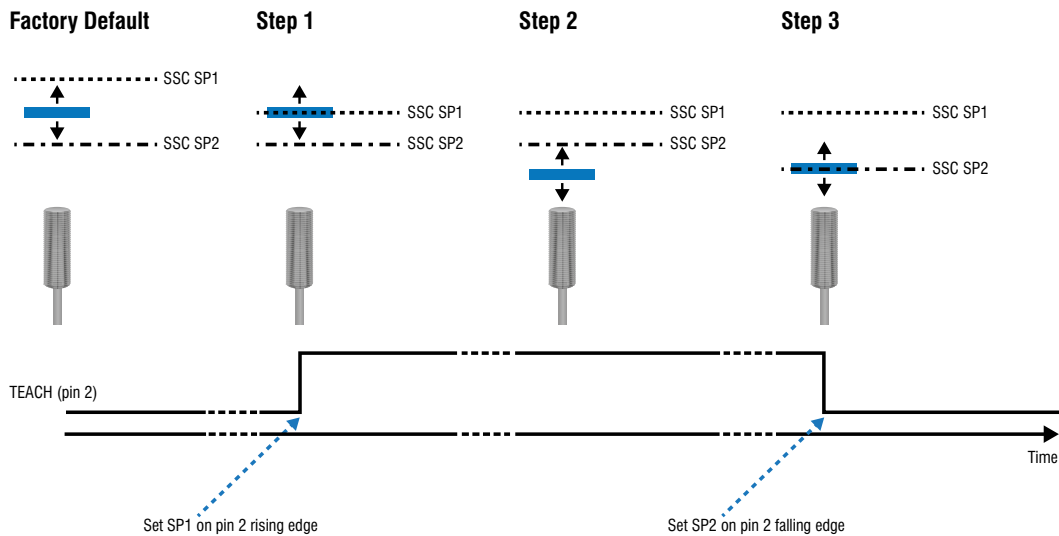

Positioning the target at the first setpoint and triggering the teach pulse sets SP1 on the rising edge of the pulse. Repositioning the target to the second setpoint and removing the teach pulse then sets SP2 on the falling edge of the pulse.

SMART FEATURES



DUAL CHANNEL

- ✓ IO-Link smart profile simplifies control-system integration
- ✓ High-speed sensor-based decision-making using SIO

LOCALIZED HIGH-SPEED CONTROL

Enabling OSS2 on Pin 2 of the Smart Sensor connector gives system integrators access to localized high-speed control options; as already noted, OSS2 operates solely in SIO mode and may be designated as an input or an output channel. In addition to D2D communication, two specific advantages stand out.

REPORTING TIME-CRITICAL EVENTS

Should a remote sensor identify an out-of-range parameter that requires immediate intervention (for example, overheating), an event-based output signal is generated to notify the central control system – in the example shown, a PLC – that a system-wide shut-down is essential. In this instance, the IO-Link output (OSS1) may not respond quickly enough to prevent the problem escalating.

Using the SIO output on OSS2, the sensor delivers a high-speed notification directly to the PLC, bypassing the IO-Link channel and initiating the shut-down sequence immediately. The Smart Sensor's dual-channel capability ensures that further, costly damage is avoided and that subsequent process down-time is minimized.

DECENTRALIZED CONTROL

Smart Sensors are also ideally suited to non-critical, decentralized process tasks under local control. In the example shown, a local SIO input signal on OSS2 enables or inhibits the operation of the sensor without the need to route the command via the PLC. This configuration consumes little or no system-wide resource, requiring only a confirmatory IO-Link signal on OSS1 to update the sensor status in due course.

With OSS2 signal alternatively configured in output mode, the Smart Sensor may, for example, control the operation of a local sub-system, again without the need to route the command via the PLC. Using the signal to switch a simple two-state device allows the sensor to control the operation of any associated non-intelligent equipment, for example an actuator or an electrical circuit.

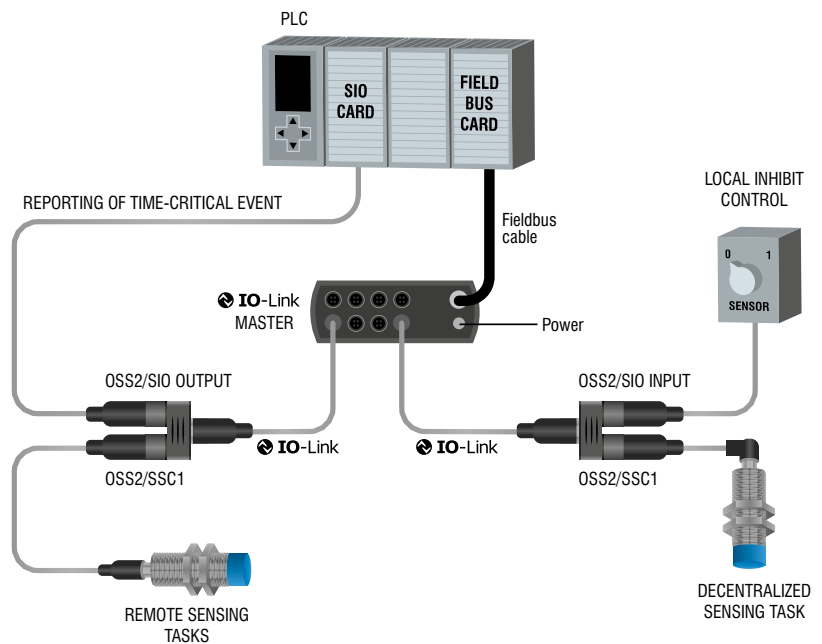



PREDICTIVE MAINTENANCE FEATURES

- ✓ **Condition-based self-monitoring minimizes maintenance costs**
- ✓ **Plug-and-play sensor replacement**

SAVING TIME BY DESIGN

In a fast-moving process-manufacturing environment, down-time is a major cost factor. While some interruptions to production are inevitable, minimizing lost time is a priority, and Smart Sensors offer big benefits here, saving time by design.

PLUG-AND-PLAY REPLACEMENT

Once initial commissioning is completed, each sensor's configuration is stored automatically on the local IO-Link Master; this allows plug-and-play replacement of sensors should the need arise, without any loss of functionality and without any need for recalibration. Down-time and the associated maintenance cost is kept to a minimum.

CYCLICAL AND EVENT-BASED REPORTING

The Smart Sensor's predictive-maintenance capabilities rely on its ability to collect both process data and event data, as well as making use of its on-board cumulative-data stores. Not only can maintenance engineers monitor long-term equipment behavior, they also have confidence in the sensor's ability to flag any one-off threshold exceptions that require attention.

THRESHOLD EXCEPTIONS

The sensor's records cumulative data for distance, cycle count and temperature, with alarm thresholds set for each. Cumulative cycle-count limits for the expected life of the equipment being monitored are programmed into the sensor memory, and a threshold alarm is triggered when the set value is exceeded, typically via IO-Link, although a high-speed SIO output may be used instead.

In the case of distance and temperature, a single, ultimate limit for each parameter is set, and any measurement that exceeds either limit is sufficient to trigger an alarm; in this instance, a high-speed SIO signal is almost certainly the preferred option. Cumulative temperature measurements may also trigger a parametric-shift alarm, as explained below.

Distance

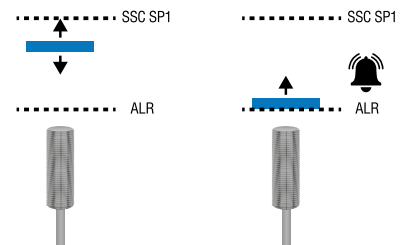

Counter



Temperature

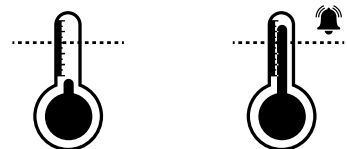

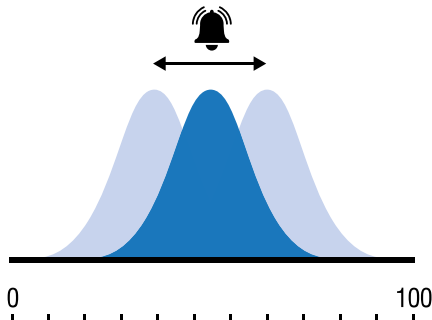

PARAMETRIC SHIFT

Stored measurements from a prolonged period of operation provide maintenance engineers with a pattern of data over time; typically, the data will form a normal distribution centered around the expected mean value for the parameter in question. Examples include, but are not limited to, equipment temperature (as above) and amplitude of vibrations.

The comprehensive data patterns allow engineers to recognize any parametric shifts that occur over time. These may include a shift in the mean value, where, for example, a sustained rise in temperature occurs at a level that isn't high enough to trigger a threshold alarm. Alternatively, an increase in the standard deviation of measurements, for example, when vibrations become unstable, may result. In either case, a parametric-shift alarm is triggered, allowing engineers to take remedial action.

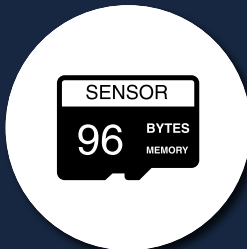

USER-DEFINED MEMORY

✓ **Unique embedded sensor ID eliminates installation errors**

EMBRACING THE INTERNET OF THINGS

The advent of the Internet of Things (IoT) has changed the way engineers look at integrated processes in manufacturing and logistics. No longer do system designers consider production lines and distribution centers to be made up of discrete components – conveyors, actuators, motors, sensors, controllers and other similar hardware – but instead they consider more complex Functional Units.

Working with a functional unit, the need to identify individual components remains as important as ever; installing the wrong sensor could have far-reaching consequences. Contrinex Smart Sensors make it simple to get the right device in the right place, eliminating errors and avoiding costly interventions.

CUSTOMIZED SENSOR-DATA TAGS

Within each Smart Sensor, three read-write data tags are reserved for user-defined information. Designated the function tag, the location tag and the application-specific tag, respectively, they link individual sensors to specific applications or tasks, allowing process engineers to locate a discrete device quickly and easily. This simplifies installation and maintenance when more than one sensor is used in a single functional unit.

TAG NAME	SIZE [BYTE]	EXAMPLES
Function Tag	32	"Drive", "Feed", "Forward"
Location Tag	32	"AQ3.1", "S45-2"
Application-Specific Tag	32	"end of motion", "piston #1", "fwd stroke"



**MULTI-MODE
HIGH-RESOLUTION
MEASUREMENT**



**EMBEDDED PREDICTIVE-
MAINTENANCE FEATURES**

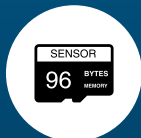

**USER-DEFINED
MEMORY**



**USER-CONFIGURABLE
OUTPUTS**



**DIRECT DEVICE-TO-DEVICE
COMMUNICATION**



DUAL CHANNEL

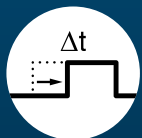

DELAY



STRETCH



ONE SHOT



TEMPERATURE



BITE



**DETECTION
COUNTER**

We attempt to ensure that the information in this brochure is accurate, however, this information may contain technical errors, typographical errors, and inaccuracies. We reserve the right to correct these errors and decline any liability in relation with this brochure. Furthermore, the smart factory use cases described in this brochure are for illustrative purposes only. We decline any liability related the feasibility or efficiency gains of these example cases applied to real applications.

Terms of delivery and right to change design reserved.

HEADQUARTERS

CONTRINEX AG Industrial Electronics
Route du Pâqui 3 – PO Box – CH-1720 Corminboeuf
Switzerland
Tel: +41 26 460 46 46 – **Fax:** +41 26 460 46 40
Internet: www.contrinex.com – **E-mail:** info@contrinex.com



© **CONTRINEX AG** 2023
900-310-002 – 04.23 – 1000