

HOUSING	OPERATING DISTANCE	MOUNTING
M8	0 ... 4/6 mm	Embeddable/ Non-embeddable

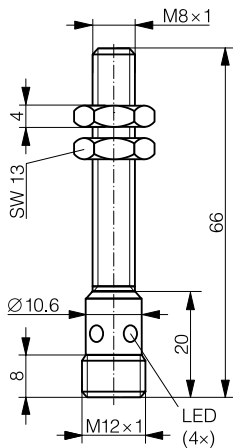

IDWE-M8MP-NMS-A0

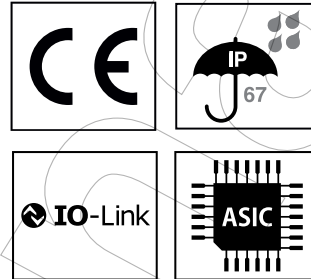
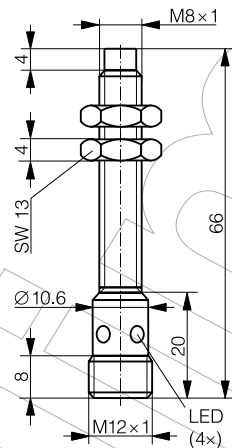

IDWN-M8MP-NMS-A0

DETECTION DATA		INTERFACE	
Sensing distance	110% S_d	Output on pin 4	SIO Selectable / IO-Link
Operating distance (S_d)	See table "Available types" (p. 2)	Output on pin 2	SIO Selectable
Temperature drift (0 ... 0.8 S_d)	$\leq 10\% S_d$	Output Polarity	PNP
		IO-Link	✓
		MTTF (@40°C)	-

ELECTRICAL DATA		MECHANICAL DATA	
Supply voltage range (U_b)	18...30 VDC (IO-Link) / 10...30 VDC (SIO)	Mounting	See table "Available types" (p. 2)
Residual ripple	$\leq 20\% U_b$	Housing material	Chrome-plated Nickel Silver
Output current	≤ 200 mA	Sensing face material	PBTP
Output voltage drop	≤ 2.0 VDC	Max. tightening torque	See "Installation conditions" (p. 2)
Power consumption (no-load)	≤ 20 mA	Ambient operating temperature	-25 ... +70°C ¹
Residual current	≤ 0.1 mA	Enclosure rating	IP67
Max. sampling rate	1,000 Hz	Weight (cable/connector)	See table "Available types" (p. 2)
Short-circuit protection	✓	Shock and vibration	IEC 60947-5-2/7.4
Voltage reversal protection	✓		
Cable length max.	≤ 20 m (IO-Link) / ≤ 300 m (SIO)		

Note: all data measured according to IEC 60947-5-2 standard with $U_b = 20 \dots 30$ VDC, $T_A = 23^\circ\text{C} \pm 5^\circ\text{C}$.

¹ Maximum temperature according to UL: 70°C.

CORRECTION FACTORS

	Steel FE 360	Copper	Aluminum	Brass	Stainless steel V2A
IDWE-M8MP-NMS-A0	1	0.34	0.4	0.5	0.76
IDWN-M8MP-NMS-A0	-	-	-	-	-

Note: the operating distance of the sensor must be multiplied by the correction factor of the material. For example, the operating distance on Aluminum is $S_{n, Al} = S_n \times CF_{Al}$. In case of embeddable mounting, the distance is multiplied by the additional correction factor of the support, thus $S_{n, Al} = S_n \times CF_{Al} \times CF_{emb, Al}$.

INSTALLATION CONDITIONS / MAXIMUM TIGHTENING TORQUE

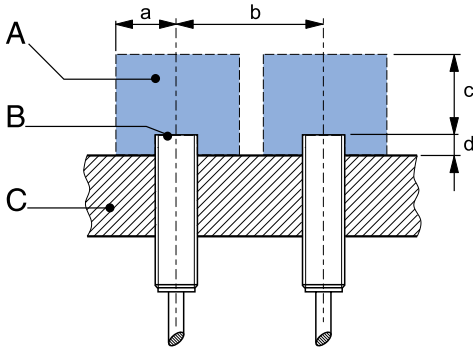

A : metal free zone
B : sensing face
C : support

	a	b	c	d	Max. Tightening Torque
IDWE-M8MP-NMS-A0	8	12	12	1	8 Nm (2.5 Nm first 10 mm)
IDWN-M8MP-NMS-A0	-	-	-	-	8 Nm

Note: additional installation information can be found in the glossary of the Contrinex General Catalog.

WIRING DIAGRAM

PIN ASSIGNMENT

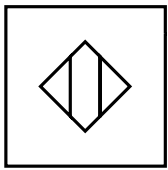

bn
bk
wh
bu

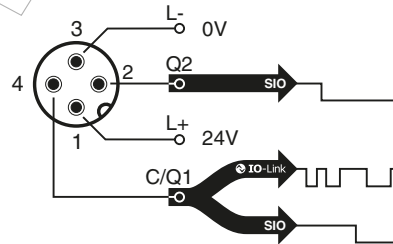
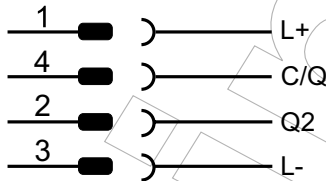

IO-LINK CHARACTERISTICS VALUE FOR IDWx-MxxMP-NMS-A0

Vendor ID	0156 _h
Device ID	320101 _h
IO-Link Protocol	1.1
SIO-Mode	Supported
Process data	4 bytes input / 1 bytes output
Baudrate	COM2 (38.4 kBaud)
Minimum cycle time	4 ms



IODD files may be downloaded from
www.contrinex.com/product-range/inductive-sensors/
Select the product name to display the product page with corresponding downloads.
Alternatively, just click/scan the QR code on the left.

AVAILABLE TYPES All the below specifications were obtained with a 3-S_d × 3-S_d × 1 mm³, FE 360 standard target

Part number	Part reference	S _d	Mounting	Repeat accuracy	Resolution (@0.67-S _d)		Linearity	Weight
					Static	Dynamic		
330-020-494	IDWE-M8MP-NMS-A0	0... 4 mm	Embeddable	< 6 μm ⁽¹⁾ / 50 μm ⁽²⁾	< 5 μm ⁽³⁾	< 15 μm ⁽³⁾	± 30 μm ⁽⁴⁾	20 g
330-020-495	IDWN-M8MP-NMS-A0	0... 6 mm	Non-embeddable	-	-	-	-	20 g

⁽¹⁾ measured under 3σ confidence level (99.7%) at 0.33 S_d, constant temperature and constant voltage supply

⁽²⁾ measured under 3σ confidence level (99.7%) at 0.67 S_d, constant temperature and constant voltage supply

⁽³⁾ measured under σ confidence level (RMS value) at 0.67 S_d, constant temperature and constant voltage supply

⁽⁴⁾ measured under a range condition from 5% to 95% S_d, constant temperature and constant voltage supply

Note: part reference may include additional suffix to indicate a revision version or special version. Further information is available on request.

CONFIGURATION PARAMETER (IO-LINK / SIO MODE)

Index	Sub Hex	Name	Access	Data Type	Value	Default
SYSTEM						
02 _h	00 _h	Standard Command ⁽¹⁾	W	uint8	05 _h = ParamDownloadStore, 40 _h = Teach Apply, 41 _h = Single Value Teach SP1, 42 _h = Single Value Teach SP2, 43 _h = Two Value Teach for SP1 → TP1, 44 _h = Two Value Teach for SP1 → TP2, 45 _h = Two Value Teach for SP2 → TP1, 46 _h = Two Value Teach for SP2 → TP2, 47 _h = Dynamic Start SP1, 48 _h = Dynamic Stop SP1, 49 _h = Dynamic Start SP2, 4A _h = Dynamic Stop SP2, 4F _h = Teach Cancel, 80 _h = Device Reset, 82 _h = Restore Factory Settings, A0 _h = Locate Device, A1 _h = Clear MHM BIN	N/A
DATA STORAGE						
03 _h	01 _h	DS_Command ⁽¹⁾	R/W	uint8	00 _h : Reserved 01 _h : DS_UploadStart 02 _h : DS_UploadEnd 03 _h : DS_DownloadStart 04 _h : DS_DownloadEnd 05 _h : DS_Break 06 _h – FF _h : Reserved	N/A
	02 _h	State_Property ⁽¹⁾	R	uint8	Bit 0: Reserved Bit 1 and 2: State of Data Storage (00 _h : Inactive, 01 _h : Upload, 02 _h : Download, 03 _h : Data Storage Locked) Bit 3 to 6: Reserved Bit 7: DS_UPLOAD_FLAG (00 _h : no DS_UPLOAD_ FLAG, 01 _h : DS_UPLOAD_REQ pending)	N/A
	03 _h	Data_Storage_Size	R	uint32	FFh	N/A
	04 _h	Parameter_Checksum	R	uint32	–	N/A
	05 _h	Index_List	R	array of byte	–	N/A
DEVICE ACCESS LOCKS						
0C _h	–	Device Access Lock	R/W	uint16	Parameter Access, Data Storage, Local Parametrization and Local User Interface Locks	0000 _h
PROFILE PARAMETER						
0D _h	–	Profile Characteristic	R	uint16	<ProfileID1>, <ProfileID2>, <ProfileID3>, <FCID> [0018] _h , [800A] _h , [800C] _h , [800D] _h (Type 4.3.1) (DMSS)	–
PD DESCRIPTOR						
0E _h	–	PD Input Descriptor	R	array	<DataType><TypeLength><BitOffset> – [1] _h [8] _h [0] _h [2] _h [8] _h [8] _h [2] _h [10] _h [10] _h	–
0F _h	–	PD Output Descriptor	R	array	<DataType><TypeLength><BitOffset> – [1] _h [1] _h [0] _h	–
FUNCTION CLASS – IDENTIFICATION (8000_h)						
10 _h	–	Vendor Name	R	char [16]	“Contrinex”	–
11 _h	–	Vendor Text	R	char [32]	“www.contrinex.com”	–
12 _h	–	Product Name	R	char [32]	“IDWx-M8MP-NMS-A0”	–
13 _h	–	Product ID	R	char [16]	330-020-4xx	–
14 _h	–	Product Text	R	char [32]	DMSS series inductive sensor	–
15 _h	–	Serial Number	R	char [16]	123456	–
16 _h	–	Hardware Revision	R	char [16]	1.0.0	–
17 _h	–	Firmware Revision	R	char [16]	1.0.0	–
18 _h	–	Application Specific Tag	R/W	char [32]	<user string, 32 bytes (variable length)>	<vendor specific>
FUNCTION CLASS – DIAGNOSIS (8003_h)						
24 _h	00 _h	Device Status ⁽¹⁾	R	uint8	0 = Device is OK, 1 = Maintenance required, 2 = Out of specification, 3 = Functional check, 4 = Failure, 5...255 Reserved	–
25 _h	00 _h – 03 _h	Detailed Device Status ⁽¹⁾	R	uint8 [3]	–	–

⁽¹⁾This parameter is stored in a volatile memory

FUNCTION CLASS – TEACH-IN CHANNEL SELECT (8004 _h)						
3A _h	–	Teach Select ⁽¹⁾	R/W	uint8	00 _h : Default (SSC1) 01 _h : SSC1 02 _h : SSC2 FF _h : ALL	00 _h
FUNCTION CLASS – TEACH STATUS (8007 _h TO 8009 _h)						
3B _h	01 _h	Teach State ⁽¹⁾	R	bool[4]	00 _h : Idle 01 _h : SP1 Success 02 _h : SP2 Success 03 _h : SP12 Success 04 _h : Wait for command 05 _h : Busy 06 _h : Reserved 07 _h : Error 08 _h ...12 _h : Reserved	00 _h
	02 _h	Flag SP1 → TP1 ⁽¹⁾	R	bool	00 _h : Teach point not taught or not successful 01 _h : Teach point successfully taught	00 _h
	03 _h	Flag SP1 → TP2 ⁽¹⁾	R	bool	00 _h : Teach point not taught or not successful 01 _h : Teach point successfully taught	00 _h
	04 _h	Flag SP2 → TP1 ⁽¹⁾	R	bool	00 _h : Teach point not taught or not successful 01 _h : Teach point successfully taught	00 _h
	05 _h	Flag SP2 → TP2 ⁽¹⁾	R	bool	00 _h : Teach point not taught or not successful 01 _h : Teach point successfully taught	00 _h
SCU – SENSOR CONFIGURATION UNIT						
40 _h	01 _h	Sensor Startup Time	R/W	uint16	0 ... 65535 ms	0000 _h
	02 _h	Sensor Value Source	R/W	uint8	00 _h : Distance (VTARGET) 01 _h : Counter 02 _h : Temperature	00 _h
	03 _h	Sensor Mode	R/W	uint8	00 _h : Fast (1 kHz) 02 _h : Standard (250 Hz) 20 _h : Fine (14 Hz)	02 _h
SSC1 PARAMETER						
3C _h	01 _h	Setpoint 1	R/W	uint32	Recommended value: (2234 ... 14894 = 15% S _d to 100% S _d)	100% S _d
	02 _h	Setpoint 2	R/W	uint32	Recommended value: (2234 ... 14894 = 15% S _d to 100% S _d), but must be lower than Setpoint 1. N/A if Single-Point mode is selected.	0% S _d
SSC1 CONFIGURATION						
3D _h	01 _h	Logic	R/W	uint8	00 _h : High active 01 _h : Low active	00 _h
	02 _h	Mode	R/W	uint8	00 _h : Deactivated 01 _h : Single Point 02 _h : Window Mode 03 _h : Two Points	01 _h
	03 _h	Hysteresis Width	R/W	uint32	0 ... 16383 (e.g. If SSC1 Configuration Mode = Single Point, SP1 = 50% S _d = 7447, Hysteresis Width = 10% of SP = 745)	8% of SP
SSC2 PARAMETER						
400C _h	01 _h	Setpoint 1	R/W	uint32	Recommended value: (2234 ... 14894 = 15% S _d to 100% S _d)	80% S _d
	02 _h	Setpoint 2	R/W	uint32	Recommended value: (2234 ... 14894 = 15% S _d to 100% S _d), but must be lower than Setpoint 1. N/A if Single-Point mode is selected.	0% S _d

⁽¹⁾ This parameter is stored in a volatile memory

SSC2 CONFIGURATION						
400D _h	01 _h	Logic	R/W	uint8	00 _h : High active 01 _h : Low active	00 _h
	07 _h	Mode	R/W	uint8	00 _h : Deactivated 01 _h : Single Point 02 _h : Window Mode 03 _h : Two Points	01 _h
	08 _h	Hysteresis Width	R/W	uint32	0 .. 16383 (e.g. If SSC1 Configuration Mode = Single Point, SP1 = 50% S _d = 7447, Hysteresis Width = 10% of SP = 745)	8% of SP

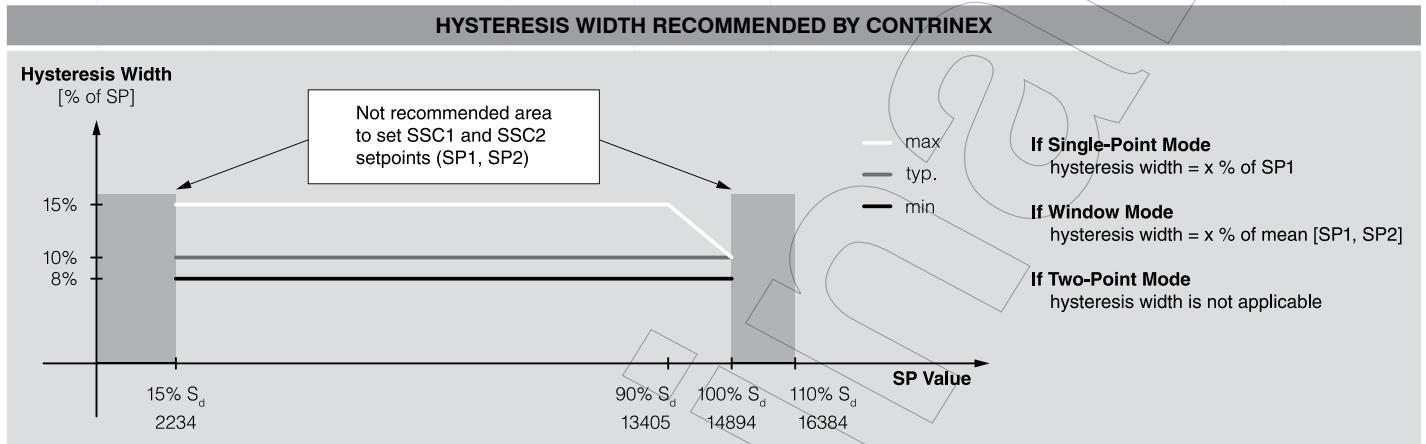

OSS CONFIGURATION						
42 _h	01 _h	OSS1 Logic – Sensor Physical Output 1 Logic (PIN4) when used in SIO mode	R/W	uint8	0 = OUTPUT: High active (NO) 1 = OUTPUT: Low active (NC) 2 = OUTPUT: ON 3 = OUTPUT: OFF	00 _h
	02 _h	OSS2 Logic – Sensor Physical Output 2 Logic (PIN2) when used in SIO mode	R/W	uint8	0 = OUTPUT: High active (NO) 1 = OUTPUT: Low active (NC) 2 = OUTPUT: ON 3 = OUTPUT: OFF 4 = INPUT 5 = INPUT-TRIGGER Single Value Teach	00 _h
	03 _h	OSS1 Condition – Sensor Physical Output 1 Condition (PIN4) when used in SIO mode	R/W	uint8	0 = OSS1_A1 1 = OSS1_A1 AND OSS1_A2 2 = OSS1_A1 OR OSS1_A2 3 = OSS1_A1 XOR OSS1_A2	00 _h
	04 _h	OSS2 Condition – Sensor Physical Output 2 Condition (PIN2) when used in SIO mode	R/W	uint8	0 = OSS2_A1 1 = OSS2_A1 AND OSS2_A2 2 = OSS2_A1 OR OSS2_A2 3 = OSS2_A1 XOR OSS2_A2	00 _h
	05 _h	OSS1 Source A1 – Sensor Physical Output 1 Source A1 (PIN4) when used in SIO mode	R/W	uint8	0 = SSC1 1 = SSC2 2 = TSSP 3 = ALR1 4 = ALR2 5 = ALR3 6 = INPUT ⁽¹⁾ 7 = Not INPUT ⁽¹⁾	00 _h
	06 _h	OSS1 Source A2 – Sensor Physical Output 1 Source A2 (PIN4) when used in SIO mode	R/W	uint8	0 = SSC1 1 = SSC2 2 = TSSP 3 = ALR1 4 = ALR2 5 = ALR3 6 = INPUT ⁽¹⁾ 7 = Not INPUT ⁽¹⁾	00 _h
	07 _h	OSS2 Source A1 – Sensor Physical Output 2 Source A2 (PIN2) when used in SIO mode	R/W	uint8	0 = SSC1 1 = SSC2 2 = TSSP 3 = ALR1 4 = ALR2 5 = ALR3	00 _h

⁽¹⁾ Only available if OSS2 Logic = 4 = INPUT

	08 _h	OSS2 Source A2 – Sensor Physical Output 2 Source A2 (PIN2) when used in SIO mode	R/W	uint8	0 = SSC1 1 = SSC2 2 = TSSP 3 = ALR1 4 = ALR2 5 = ALR3	00 _h
TMU – SENSOR TIMER UNIT						
43 _h	01 _h	Timer Mode	R/W	uint8	0 = No Timer 1 = Stretch ON 2 = Delay ON 3 = Delay and Stretch ON 4 = One Shot	00 _h
	02 _h	Timer Value	R/W	uint16	0 ... 65535 ms	0000 _h
	03 _h	Timer Source	R/W	uint8	0 = SSC1 1 = SSC2 2 = ALR1 3 = ALR2 4 = ALR3	00 _h
CTU – SENSOR COUNTER UNIT						
44 _h	01 _h	Counter Mode	R/W	uint8	0 = Falling Edge 1 = Rising Edge 2 = Both	00 _h
	02 _h	Counter Value	R/W	uint16	0 ... 65535	0000 _h
	03 _h	Counter Source	R/W	uint8	0 = SSC1 1 = SSC2 2 = TSSP 3 = ALR1 4 = ALR2 5 = ALR3	00 _h
	04 _h	Counter Reset Source	R/W	uint8	0 = ALR1 1 = ALR2 2 = ALR3	01 _h
SMU – SENSOR MONITOR UNIT						
46 _h	01 _h	Current Temperature ⁽¹⁾	R	uint16	–	0000 _h
	02 _h	Max. Lifetime Temperature	R	uint16	–	0000 _h
	03 _h	Min. Lifetime Temperature	R	uint16	–	0000 _h
	04 _h	Lifetime Temperature Cycle Count	R	uint8	–	00 _h
	05 _h	Lifetime Operating Hours	R	uint32	–	00000000 _h
	06 _h	Lifetime Power-On Cycles	R	uint32	–	00000000 _h
	07 _h	Lifetime EMC Disturbances	R	uint32	–	00000000 _h
	08 _h	EVENT FLAG ⁽¹⁾⁽²⁾	R	uint8	0 = B0 (Coil failure) 1 = B1 (Short circuit on output) 2 = B2 (EMC disturbances) 3 = B3 (Collision on output) 4 = B4 (Over temperature) 5 = B5 (Under voltage)	00 _h
SMAU – SENSOR MEASUREMENT ALARM UNIT						
47 _h	01 _h	Sensor Alarm 1 Threshold	R/W	uint16	0 ... 110% S _d	10% S _d
	02 _h	Sensor Alarm 1 Hysteresis	R/W	uint16	–	5%
	03 _h	Sensor Alarm 1 Configuration	R/W	uint8	0 = Always OFF 1 = Active 2 = Active / IO-Link Event Generation	01 _h
	04 _h	Sensor Alarm 1 Source	R/W	uint8	0 = Distance (VTARGET) 1 = Counter 2 = Temperature 3 = MHM Median 4 = MHM Deviation 50% 5 = MHM Deviation To Target Value	00 _h
	05 _h	Sensor Alarm 2 Threshold	R/W	uint16	0 ... 65535	0000 _h
	06 _h	Sensor Alarm 2 Hysteresis	R/W	uint16	–	0000 _h
	07 _h	Sensor Alarm 2 Configuration	R/W	uint8	0 = Always OFF 1 = Active 2 = Active / IO-Link Event Generation	01 _h

⁽¹⁾ This parameter is stored in a volatile memory

⁽²⁾ A read on this subindex clear all flags

	08 _h	Sensor Alarm 2 Source	R/W	uint8	0 = Distance (VTARGET) 1 = Counter 2 = Temperature 3 = MHM Median 4 = MHM Deviation 50% 5 = MHM Deviation To Target Value	01 _h
	09 _h	Sensor Alarm 3 Threshold	R/W	uint16	-25 ... 70°C	70°C
	10 _h	Sensor Alarm 3 Hysteresis	R/W	uint16	-	0000 _h
	11 _h	Sensor Alarm 3 Configuration	R/W	uint8	0 = Always OFF 1 = Active 2 = Active / IO-Link Event Generation	01 _h
	12 _h	Sensor Alarm 3 Source	R/W	uint8	0 = Distance (VTARGET) 1 = Counter 2 = Temperature 3 = MHM Median 4 = MHM Deviation 50% 5 = MHM Deviation To Target Value	02 _h

FUNCTION AND LOCATION TAG

48 _h	01 _h	Function Tag	R/W	char []	<user string, 32 bytes (variable length)>	“***”
	02 _h	Location Tag	R/W	char []	<user string, 32 bytes (variable length)>	“***”

DEVICE CHARACTERISTIC

49 _h	01 _h	Profile Compatibility	R	char []	“SSP 4.3.1 DMSS”	-
	02 _h	Detection Range Max.	R	char []	Depends on sensor type	-
	03 _h	Supply Voltage Range (U _b)	R	char []	“10...30 VDC”	-
	04 _h	Max. Output Current	R	char []	“≤ 200 mA”	-
	05 _h	Ambient Temperature Range (T _A)	R	char []	“-25 ... 70°C”	-
	06 _h	Storage Temperature Range (T _S)	R	char []	“-25 ... 70°C”	-
	07 _h	Enclosure Rating	R	char []	“IP67”	-

MHM – MEASUREMENT HISTOGRAM MODULE

4A _h	01 _h	MHM Source	R/W	uint8	0 = Distance 1 = Temperature	00 _h
	02 _h	MHM Trigger	R/W	uint8	0 ⁽²⁾ = When Input = 1 1 = When TSSP = 1	00 _h
	03 _h	Range Start	R/W	uint16	0 ... 110% S _d	0% S _d
	04 _h	Range End	R/W	uint16	0 ... 110% S _d	100% S _d
	05 _h	BIN 1 ⁽¹⁾	R	uint32	First bin of value defined by “(Range End” – “Range Start”)/16	4 × 00 _h
	06 _h	BIN 2 ⁽¹⁾	R	uint32	...	4 × 00 _h
	07 _h	BIN 3 ⁽¹⁾	R	uint32	...	4 × 00 _h
	08 _h	BIN 4 ⁽¹⁾	R	uint32	...	4 × 00 _h
	09 _h	BIN 5 ⁽¹⁾	R	uint32	...	4 × 00 _h
	10 _h	BIN 6 ⁽¹⁾	R	uint32	...	4 × 00 _h
	11 _h	BIN 7 ⁽¹⁾	R	uint32	...	4 × 00 _h
	12 _h	BIN 8 ⁽¹⁾	R	uint32	...	4 × 00 _h
	13 _h	BIN 9 ⁽¹⁾	R	uint32	...	4 × 00 _h
	14 _h	BIN 10 ⁽¹⁾	R	uint32	...	4 × 00 _h
	15 _h	BIN 11 ⁽¹⁾	R	uint32	...	4 × 00 _h
	16 _h	BIN 12 ⁽¹⁾	R	uint32	...	4 × 00 _h
	17 _h	BIN 13 ⁽¹⁾	R	uint32	...	4 × 00 _h
	18 _h	BIN 14 ⁽¹⁾	R	uint32	...	4 × 00 _h
	19 _h	BIN 15 ⁽¹⁾	R	uint32	...	4 × 00 _h
	20 _h	BIN 16 ⁽¹⁾	R	uint32	Last bin of value defined by “(Range End” – “Range Start”)/16	4 × 00 _h
	21 _h	Median ⁽¹⁾	R	uint16	-	2 × 00 _h
	22 _h	Deviation 50% ⁽¹⁾	R	uint16	-	2 × 00 _h
	23 _h	Target Value	R/W	uint16	-	2 × 00 _h
	24 _h	Deviation ⁽¹⁾	R	uint16	Deviation = Median – Target Value	2 × 00 _h

⁽¹⁾This parameter is stored in a volatile memory

⁽²⁾Option 0 only available if OSS2 Logic = 4 = INPUT

FUNCTION CLASS – MDC DESCRIPTION PARAMETER (8005_h)

4080 _h	01 _h	Lower Limit	R	int32	Lower value measurement range, see range definition in table A.5. According to SSP ⁽¹⁾ , table C.8 page 39.	0
	02 _h	Upper Limit	R	int32	Upper value measurement range, see range definition in table A.5. According to SSP ⁽¹⁾ , table C.8 page 39.	0
	03 _h	Unit Code	R	uint16	See Unit table defined in table A.7. According to SSP ⁽¹⁾ , table C.8 page 39.	0
	04 _h	Scale	R	int8	See Table B.2. According to SSP ⁽¹⁾ , table C.8 page 39.	0

⁽¹⁾ https://io-link.com/share/Downloads/Smart-Sensor-Profile/IOL-Smart-Sensor-Profile-2ndEd_V10_Mar2017.pdf

PROCESS DATA REPRESENTATION

PROCESS DATA STRUCTURE – DISTANCE, COUNTER, TEMPERATURE SENSING MODE

PROCESS DATA INPUT

Bitoffset

Byte	7	6	5	4	3	2	1	0
0	ALR3	ALR2	ALR1	SSC2	SSC1	TSS	OSS2	OSS1
1	Scale Value							
2	Measurement value (LSB)							
3	Measurement value (MSB)							

Name	Value	Description
ALR3	0	Alarm 3 is OFF
	1	Alarm 3 is ON
ALR2	0	Alarm 2 is OFF
	1	Alarm 2 is ON
ALR1	0	Alarm 1 is OFF
	1	Alarm 1 is ON
SSC2	0	Switching signal 2 is OFF
	1	Switching signal 2 is ON
SSC1	0	Switching signal 1 is OFF
	1	Switching signal 1 is ON
TSS	0	Timered selected signal is OFF
	1	Timered selected signal is ON
OSS2	0	Output switching signal 2 is OFF
	1	Output switching signal 2 is ON
OSS1	0	Output switching signal 1 is OFF
	1	Output switching signal 1 is ON

PROCESS DATA OUTPUT

Bitoffset

Byte	7	6	5	4	3	2	1	0
0	RFU							DIS

Name	Value	Description
DIS	0	Sensor is enabled
	1	Sensor is disabled

SMART SENSOR SIGNAL FLOWS

Smart sensor signal flow chart

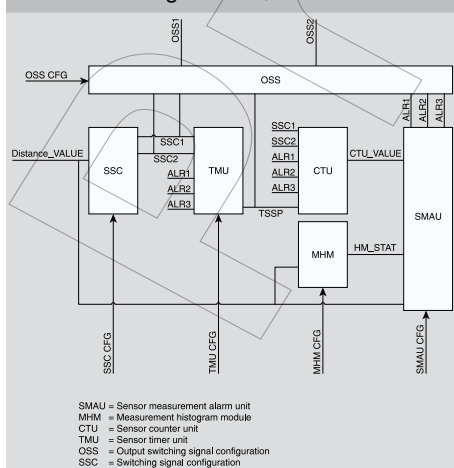

Sensor timer unit (TMU) parameter examples

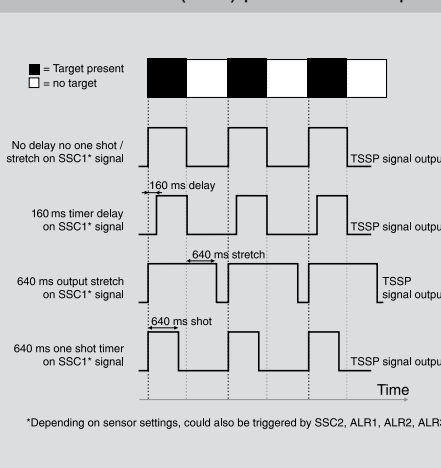

Event counter (pulse divider) example

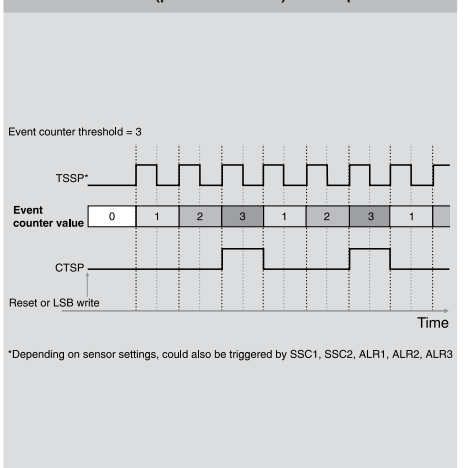

ERROR TYPES

Code	Additional code	Name	Description
80 _h	11 _h	Index Not Available	Access occurs to a not existing index
80 _h	12 _h	Subindex Not Available	Access occurs to a not existing subindex
80 _h	20 _h	Service Temporarily Not Available	Parameter is not accessible due to the current state of the device application
80 _h	21 _h	Service Temporarily Not Available – Local Control	Parameter is not accessible due to an ongoing local operation at the device
80 _h	22 _h	Service Temporarily Not Available – Device Control	Parameter is not accessible due to a remote triggered state of the device application
80 _h	23 _h	Access Denied	Write access on a read-only parameter
80 _h	30 _h	Parameter Value Out Of Range	Written parameter value is outside its permitted value range
80 _h	31 _h	Parameter Value Above Limit	Written parameter value is above its specified value range
80 _h	32 _h	Parameter Value Below Limit	Written parameter value is below its specified value range
80 _h	33 _h	Parameter Length Overrun	Written parameter length is above its predefined length
80 _h	34 _h	Parameter Length Underrun	Written parameter length is below its predefined length
80 _h	35 _h	Function Not Available	Written command is not supported by the device application
80 _h	36 _h	Function temporarily Not Available	Written command is not available due to the current state of the device
80 _h	40 _h	Invalid Parameter Set	Written single parameter collides with other actual parameter settings
80 _h	41 _h	Inconsistent Parameter Set	Parameter inconsistencies were found at the end of the block parameter transfer, device plausibility check failed
81 _h	01 _h	MHM Trigger not available	First select OSS2 Logic = INPUT

EVENTS

Code	Type	Name	Description
1800 _h	Warning	EMC Disturbances	EMC Disturbances detected by sensor
1801 _h	Warning	Under IOL Voltage	Under IOL Voltage detected by sensor
1802 _h	Error	Emitter Failure	Emitter Failure detected by sensor
1803 _h	Warning	Short Circuit	Short Circuit detected by sensor
1804 _h	Error	Under Voltage	Under Voltage detected by sensor
1805 _h	Warning	Disturbances on Receiver	Disturbances on Receiver detected by sensor
1806 _h	Warning	LED Regulation Limit	LED Regulation Limit detected by sensor
1807 _h	Error	Ferrite, Coil, PCB Failure	Ferrite, Coil, PCB Failure detected by sensor
1808 _h	Notification	Alarm 1	Alarm 1 Threshold reached
1809 _h	Notification	Alarm 2	Alarm 2 Threshold reached
180A _h	Notification	Alarm 3	Alarm 3 Threshold reached
180B _h	Notification	Trigger Teach	New SSC value is taught
5010 _h	Error	Component malfunction	Repair or exchange
7710 _h	Error	Short circuit	Check installation