

5'000 mm

- ✓ Time-of-flight (TOF)
- ✓ Laser emission
- ✓ High precision
- ✓ Digital distance measurement thanks to IO-Link

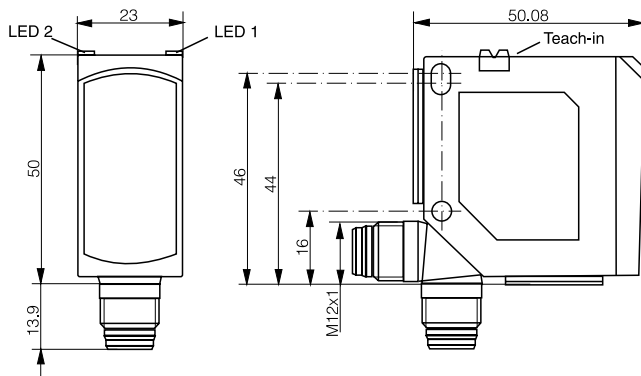
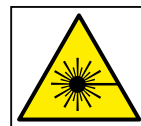

OPTICAL DATA		INTERFACE	
Measurement range	60...5'000 mm ¹	Adjustment	Teach button/input or IO-Link
Resolution	< 5 mm	Indicator LED, green	Supply voltage state
Linearity	± 30 mm ¹	Indicator LED, yellow	Sensing state
Repeatability	see diagram	IO-Link	✓
Light source	Laser class 1, red 655 nm		
Light spot size (distance)	5 x 4 mm ² (3'000 mm)		

¹Object with 18%...90% reflectance (standard gray to white paper)

ELECTRICAL DATA		MECHANICAL DATA	
Supply voltage range (U _b)	18...30 VDC	Enclosure rating	IP67 & IP69K
Output current	≤ 100 mA	Ambient temperature operation	-40...+60°C (UL: max +45°C)
Signal PNP high/low	≤ (U _b -2.0 V)/ approx. 0 V	Shock and vibration	IEC 60947-5-2
Signal NPN high/low	Approx. U _b / ≤ 2.0 V	Weight (connector version)	42 g
Power consumption (no load)	≤ 60 mA	Weight (cable version)	-
Response time (analog)	1 ms	Housing material	ABS
Switching frequency	≤ 500 Hz	Window material	PMMA
Short circuit protection	✓	Connection cable	-
Voltage reversal protection	✓	Connector type	M12 4-pin

MEASUREMENT RANGE

IO-LINK FUNCTIONALITIES

Target	Measurement range
90%	60...5'000 mm
18%	60...5'000 mm
6%	60...3'000 mm

IO-Link version	1.1
SIO mode	Supported
Data storage	Supported
Baudrate	COM2 (38.4 kBaud)
Process data	Measurement value, switching outputs 1 & 2, signal quality
Parameters	According to IO-Link "Smart Sensor Profile", teach functions, etc.
Special functions	Counter operating hours & switch cycles, filter, signal quality level control, etc.

IO-Link specifications and IODD files may be downloaded from www.contrinex.com (Download section)

REPEATABILITY¹

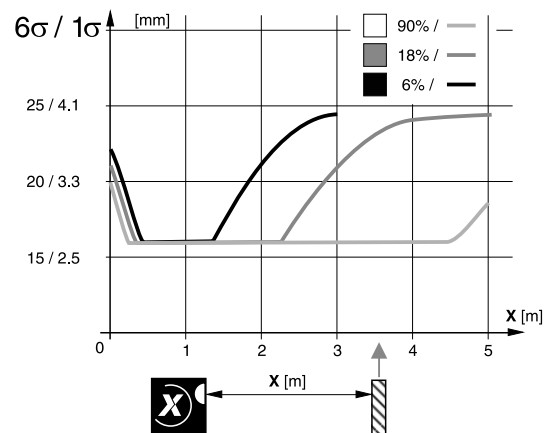
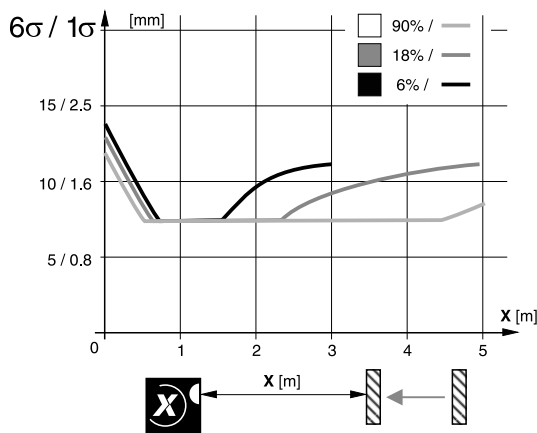

¹At constant ambient conditions

WIRING DIAGRAM

PIN ASSIGNMENT

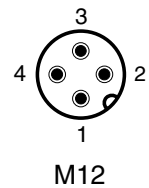
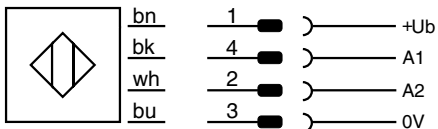

AVAILABLE TYPES

Part number	Part reference	Polarity	Connection	Output (A1)	Input (A2)
628-000-702	DTL-C55PA-TMS-407-505	PNP/NPN auto-detect	Connector M12 4-pin	Light/Dark-on/IO-Link	Teach

Note: additional suffix can appear to indicate a revision version or a special version.

Operators of the products we supply are responsible for compliance with measures for the protection of persons. The use of our equipment in applications where the safety of persons might be at risk is only authorized if the operator observes and implements separate, appropriate and necessary measures for the protection of persons and machines. Terms of delivery and rights to change design reserved.

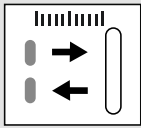

5'000 mm

- ✓ Time-of-flight (TOF)
- ✓ Émission laser
- ✓ Haute précision
- ✓ Mesure de distance numérique grâce à IO-Link

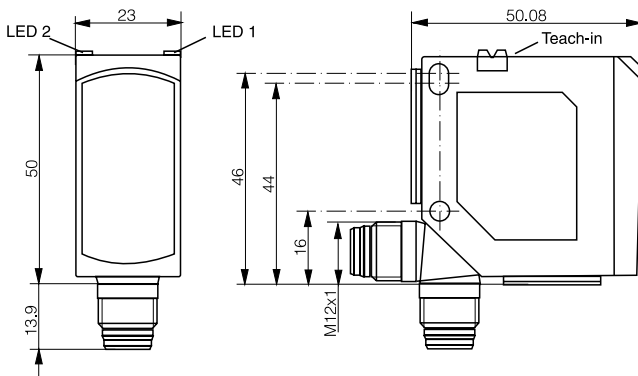
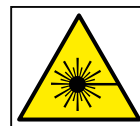

DONNÉES OPTIQUES		INTERFACE	
Domaine de mesure	60...5'000 mm ¹	Réglage	Bouton/entrée 'teach' ou IO-Link
Résolution	< 5 mm	Indicateur LED, vert	État de la tension d'alimentation
Linéarité	± 30 mm ¹	Indicateur LED, jaune	État de détection
Répétabilité	voir schéma	IO-Link	✓
Source lumineuse	Laser classe 1, rouge 655 nm		
Taille tache lumineuse (distance)	5 x 4 mm ² (3'000 mm)		

¹Objet avec 18%...90% de réflectance (papier gris...blanc standard)

DONNÉES ÉLECTRIQUES		DONNÉES MÉCANIQUES	
Tension d'alimentation (U _b)	18...30 VDC	Indice de protection	IP67 & IP69K
Courant de sortie	≤ 100 mA	Temp. ambiante d'utilisation	-40...+60°C (UL: max +45°C)
Signal PNP high/low	≤ (U _b -2.0 V)/ env. 0 V	Chocs et vibrations	IEC 60947-5-2
Signal NPN high/low	env. U _b / ≤ 2.0 V	Poids (version connecteur)	42 g
Consommation (hors charge)	≤ 60 mA	Poids (version câble)	-
Temps de réponse (analogique)	1 ms	Matériau du boîtier	ABS
Fréquence de commutation	≤ 500 Hz	Matériau de la fenêtre	PMMA
Protection contre les courts circuits	✓	Câble de raccordement	-
Protection contre les inversions	✓	Type de connecteur	M12 4 pins

DOMAINE DE MESURE

FONCTIONNALITÉS IO-LINK

Cible	Domaine de mesure
90%	60...5'000 mm
18%	60...5'000 mm
6%	60...3'000 mm

Version IO-Link	1.1
Mode SIO	Disponible
Data storage	Disponible
Baudrate	COM2 (38.4 kBaud)
Process data	Valeur de la mesure, état des sorties 1 et 2, qualité du signal
Paramètres	Selon IO-Link "Smart Sensor Profile", fonctions teach, etc.
Fonctions spéciales	Compteur des heures d'opération et de détections, filtre, contrôle de la qualité du signal

Les spécifications IO-Link et les fichiers IODD peuvent être téléchargés depuis www.contrinex.com (onglet Télécharger)

RÉPÉTABILITÉ¹

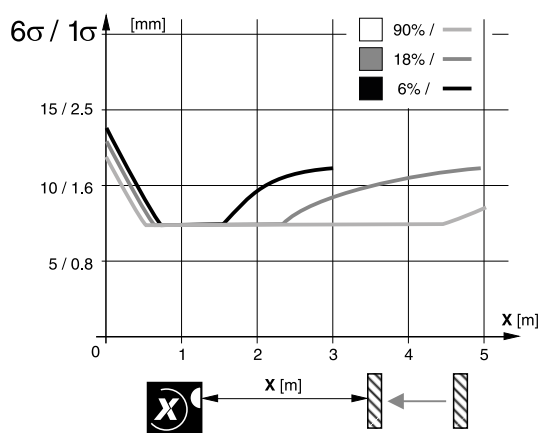

¹Dans des conditions ambiantes constantes



SCHÉMA DE RACCORDEMENT

ATTRIBUTION DES PINS

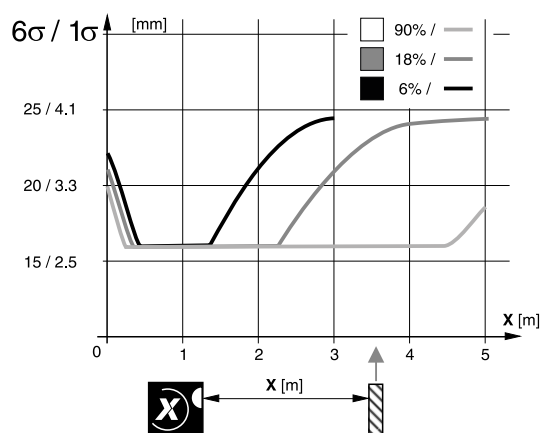
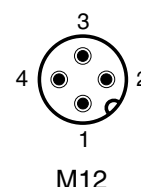
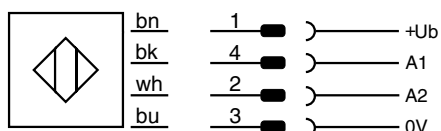

TYPES DISPONIBLES

No. d'article	Désignation	Polarité	Raccordement	Sortie (A1)	Entrée (A2)
628-000-702	DTL-C55PA-TMS-407-505	PNP/NPN détect. auto	Connect. M12 4 pins	en/sans récept./IO-Link	Teach

Remarque: la présence d'un suffixe supplémentaire indique une version révisée ou une version spéciale.

Les exploitants des produits que nous fournissons sont tenus d'assurer des mesures adéquates de protection des personnes. L'utilisation de nos appareils dans des applications comportant un risque possible pour la sécurité des personnes n'est admissible que si l'exploitant observe et met en œuvre des mesures séparées, appropriées et nécessaires pour la protection des personnes et des machines. Sous réserve de modifications et de possibilités de livraison.

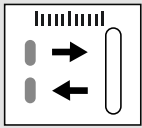

5'000 mm

- ✓ Time-of-flight (TOF)
- ✓ Laseremission
- ✓ Hohe Präzision
- ✓ Digitale Abstandsmessung dank IO-Link

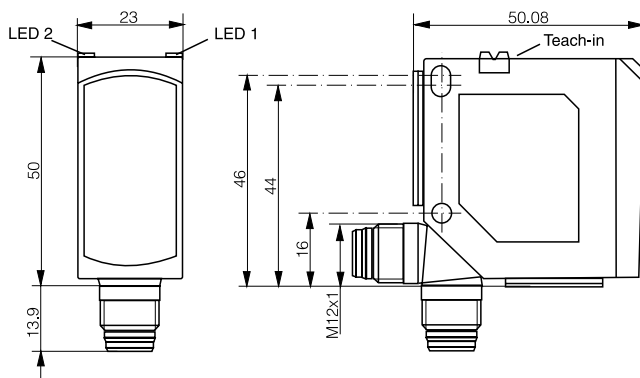
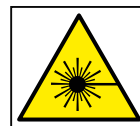
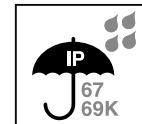

OPTISCHE DATEN		INTERFACE	
Messbereich	60...5'000 mm ¹	Einstellung	Teach-Taste/Eingang oder IO-Link
Auflösung	< 5 mm	Anzeige-LED, grün	Versorgungsspannungs-Status
Linearität	± 30 mm ¹	Anzeige-LED, gelb	Erfassungsstatus
Wiederholgenauigkeit	siehe Schema	IO-Link	✓
Lichtquelle	Laserklasse 1, rot 655 nm		
Lichtfleckgrösse (Entfernung)	5 x 4 mm ² (3'000 mm)		

¹Objekt mit 18...90% Reflexion (standardgraues...-weisses Papier)

ELECTRISCHE DATEN		MECHANISCHE DATEN	
Versorgungsspannungsber. (Ub)	18...30 VDC	Schutzart	IP67 & IP69K
Ausgangsstrom	≤ 100 mA	Umgebungstemperatur Betrieb	-40...+60°C (UL: max +45°C)
PNP-Signal high/low	≤ (Ub-2.0 V)/ ca. 0 V	Schocks und Vibrationen	IEC 60947-5-2
NPN-Signal high/low	ca. Ub/ ≤ 2.0 V	Gewicht (Steckerversion)	42 g
Stromaufnahme (ohne Last)	≤ 60 mA	Gewicht (Kabelversion)	-
Ansprechzeit (analog)	1 ms	Gehäusematerial	ABS
Schaltfrequenz	≤ 500 Hz	Fenstermaterial	PMMA
Kurzschlusschutz	✓	Anschlusskabel	-
Verpolungsschutz	✓	Anschlusstecker	M12 4-Pin

MESSBEREICH IO-LINK-FUNKTIONALITÄTEN

Objekt	Messbereich
90%	60...5'000 mm
18%	60...5'000 mm
6%	60...3'000 mm

IO-Link-Version	1.1
SIO-Modus	Unterstützt
Data Storage	Unterstützt
Baudrate	COM2 (38.4 kBaud)
Prozessdaten	Messwert, Schaltpunkte 1 & 2, Signalqualität
Parameter	Gemäss IO-Link "Smart Sensor Profile", Teach Funktionen, usw.
Sonderfunktionen	Betriebsdauer, Aktuelle Schaltzyklen, Filter, Kontrolle Signalqualität, usw.

IO-Link-Spezifikationen und IODD-Dateien werden von www.contrinex.com heruntergeladen (Register Download)

WIEDERHOLGENAUIGKEIT¹

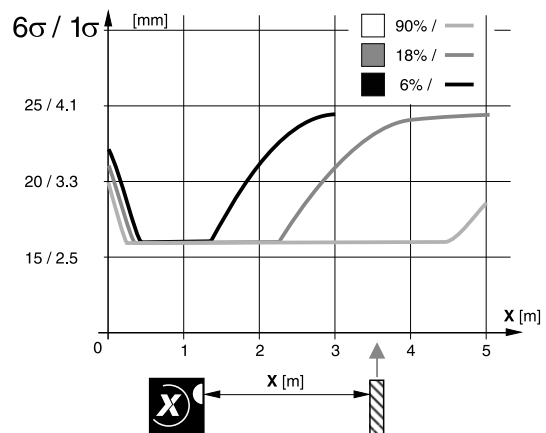
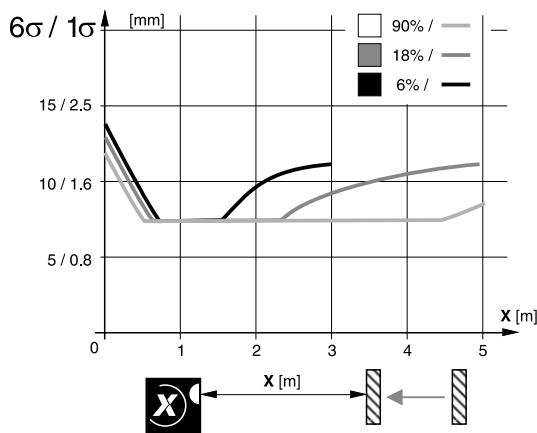

¹Bei konstanten Umgebungsbedingungen

ANSCHLUSSSCHEMA STECKERBELEGUNG

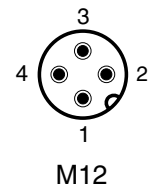
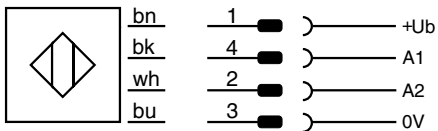

VERFÜGBARE TYPEN

Art.-Nummer	Bezeichnung	Polarität	Anschluss	Ausgang (A1)	Eingang (A2)
628-000-702	DTL-C55PA-TMS-407-505	PNP/NPN Auto-Detect	Stecker M12 5-Pin	hell-/dunkelsch./IO-Link	Teach

Hinweis: Im Fall einer überarbeiteten Version oder Sonderausführung kann die Bezeichnung auch durch eine Endung ergänzt werden.

Die Einhaltung der Personenschutzmaßnahmen obliegt dem Betreiber der von uns gelieferten Produkte. Der Einsatz unserer Geräte in Anwendungen, bei welchen die Sicherheit von Personen gefährdet sein könnte, ist nur dann zulässig, wenn der Betreiber gesonderte geeignete und notwendige Maßnahmen für die Personen- und Maschinensicherheit einhält und vornimmt. Änderungen und Liefermöglichkeiten vorbehalten.