

**User Manual for Mearth S PRO  
E- Scooter 2022-2025**

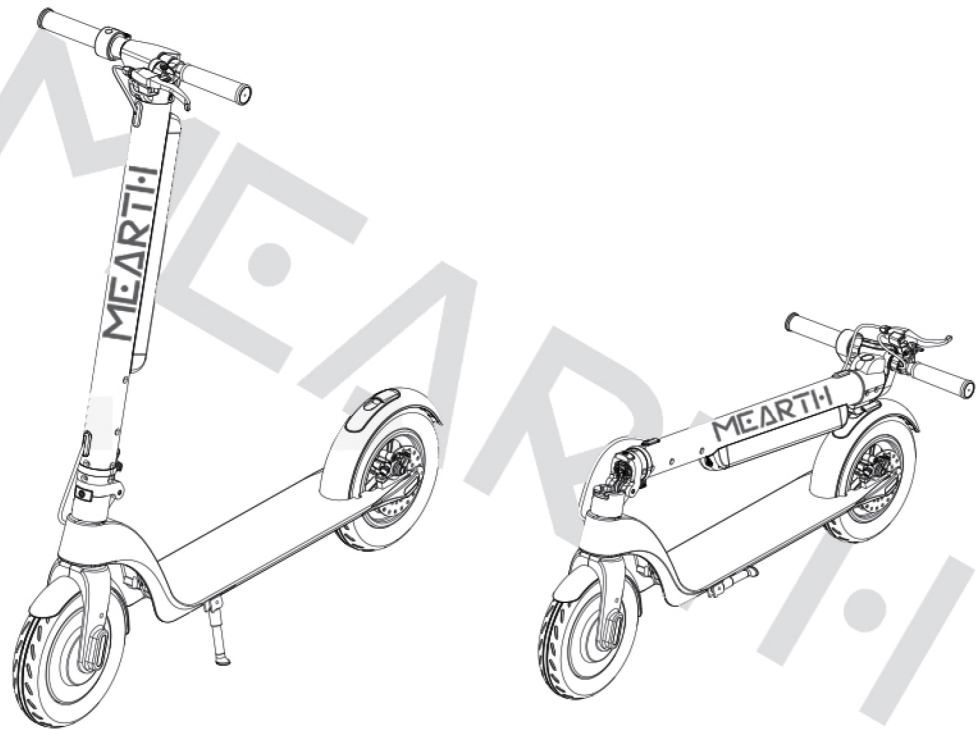

## About the manual

- Congratulations on your purchase of the E-scooter.
- For your driving Safety, please read this user manual carefully before using and ensure to be able to ride the scooter under correct guidance. Learning all the safety warning and tips listed in this manual that will be helpful for you to better control the scooter.
- Please note "warnings" and "tips" in this manual particularly.  
**Warnings:** Improper operation may result in personal injury.  
**Tips:** Helpful advice & clues for the usage of E-scooter.
- Should you have any inquiries, please contact the supplier immediately.

### Tips:

- A. Children below 14 years old shall be accompanied by an adult.
- B. The people without experience, poor ability to accept & physical coordination, should learn to ride with accompanys. Please read this manual carefully before you ride the electric scooter, make sure that you can riding with correct guide.
- C. No parents Accompanied, children are prohibited from cleaning and maintenance of the product.

### WARNING!

**IMPROPER USE OF THE scooter AND/OR FAILURE TO READ THIS USER MANUAL MAY LEAD TO SERIOUS BODILY INJURY .SELLER WILL TAKE NO RESPONSIBILITY FOR ANY INJURIES CAUSED BY IMPROPER USE WITHOUT FOLLOWING THE MANUAL.**

## Content

1.Safety Notes.....	3-5
2.Product Introduction .....	6-10
3.How to ride.....	11-12
4.Battery Instruction.....	13-14
5.Parameter .....	15
6.Maintenance.....	16
7.Trouble shooting.....	17
8.Packing List .....	17

# 1 Safety Notes

## 1.1 About safety

There's risk for any vehicle, including e-scooter. For your safety, please learn to ride safely and obey the local rules and enjoy the riding.

- Please check if the tire is damaged or the spare parts are tight before riding. Please contact local distributor for any unexpected situation.
- Please do not do anything that may harm other people or their properties with e-scooter.
- Any conversion of the e-scooter is prohibited as it will change its performance or damage the structure, which may bring serious injury.
- Please do not put the electric scooter in the water, which will not only damage the electric scooter, but also cause a safety accident.

## 1.2 Safety Precautions

Please note that you may lose balance, crash or fall down when you ride an e-scooter. To avoid injury, you should be familiar with this manual and keep the e-scooter in good condition.

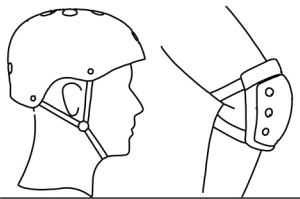

- ⚠ Safety measurements should be taken before riding, eg: wear sportswear, helmet, kneecap, elbow pads and so on.



- ⚠ DO NOT ride when it rains.

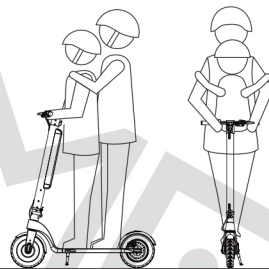

- ⚠ DO NOT ride with loading. DO NOT ride with two people or more, only for one rider.



- ⚠ People between 14 and 60 years old may use the product, pregnant is not allowed to ride the e-scooter.

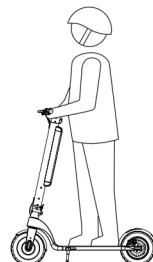

- ⚠ Max Loading: 100 kg



- ⚠ DO NOT ride after drinking or taking medicine.

## 2 Production Introduction

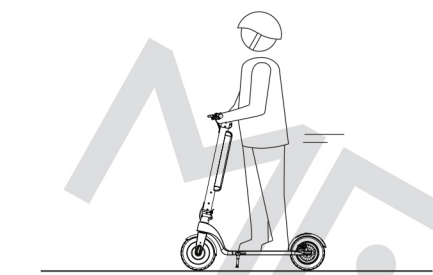

DO NOT call or listen to music when you ride the e-scooter.

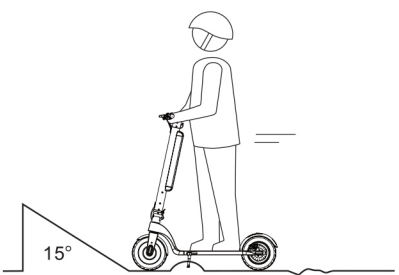

Be careful of the road with roadblock, sandstone, ponding, mud, wet, ice and snow, slope (angle >15°) stairs, dark area when you are riding.



DO NOT park in the building foyer, evacuation corridor or safety exit.

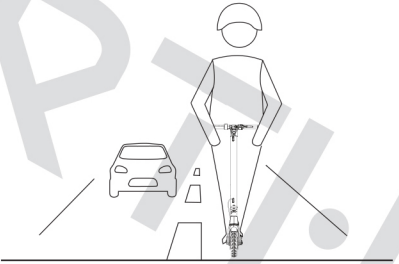

DO NOT ride on Vehicle road.

### 2.1 Overall View

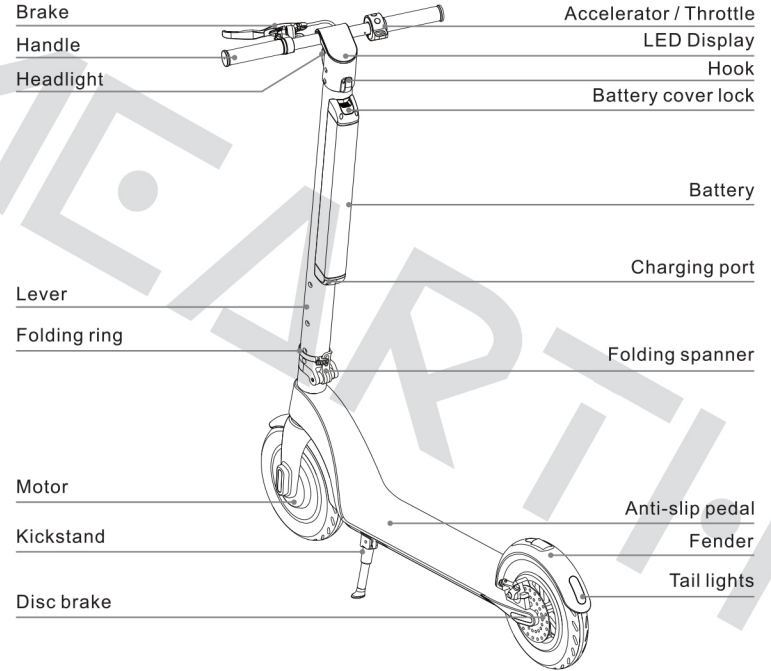

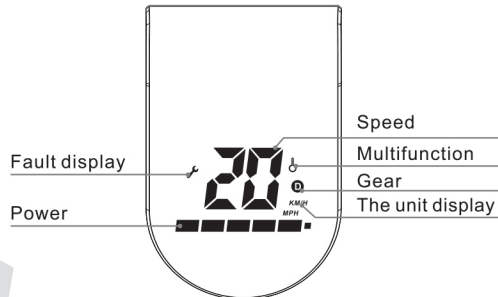
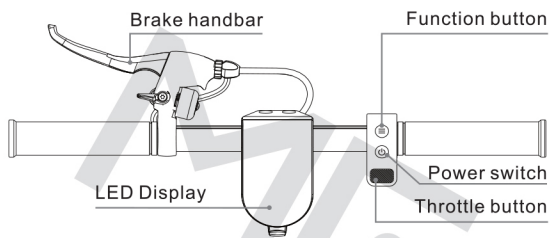

## Instructions of Buttons

- 1. Power Switch:** Long press the power button to turn on/off.
- 2. Function key:**
  - A:** Short press function key: Cycle to switch gears.  
 Beginner mode: Gear indicator is not displayed.  
 Normal mode: Gear indicator shows white.  
 Sports mode: Gear indicator shows red.
  - B:** Shortly press the function key twice to turn on/off the headlights, and the taillights are always on.
- 3. Accelerator:** Press the acceleration button to start and accelerate.
- 4. Brake:** Hold the brake handle to brake. Lightly step on the rear fender to assist the brakes.
- 5. Cruise mode:** Keep the current speed for 6 seconds to enter the cruise mode;  
 Exit the cruise mode when pressing accelerator again or brake.

## LED display

## 2.2 Pre-assembly instructions

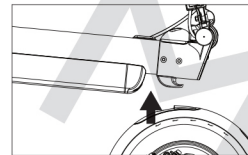

1. Pull up the lever while pressing down the rear wheel fender.

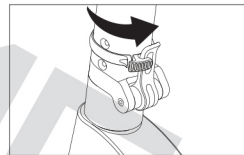

2. Fasten the folding spanner and use the folder fixing ring to fix the folder wrench.

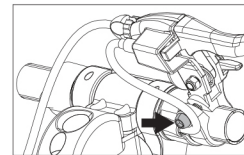

3. Fix the brake lever with M5 hex wrench.

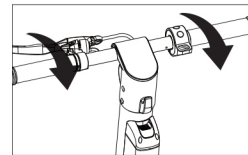

4. Tighten handlebars (Pay attention to the direction of rotation when tighten).

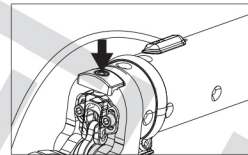
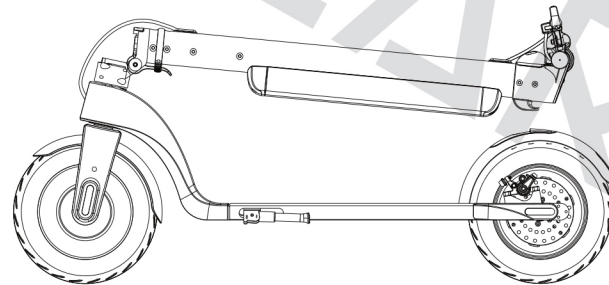

5. Adjusting the folding nut properly according to the shaking situation of lever.

## 2.3 Folding chart

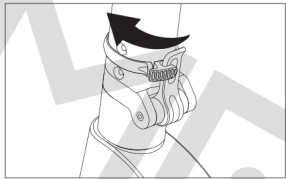

1. Loosen the folder fixing ring.

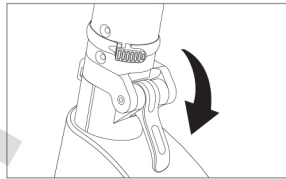

2. Open the folder wrench.

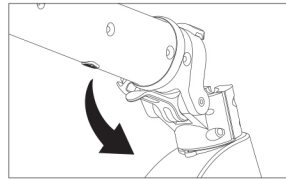

3. Fold the pole and fix the wrench.

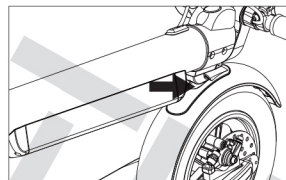

4. Gently press down to hook.

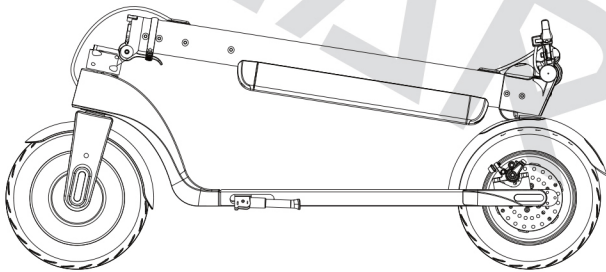

## 2.4 How to uninstall / install the battery

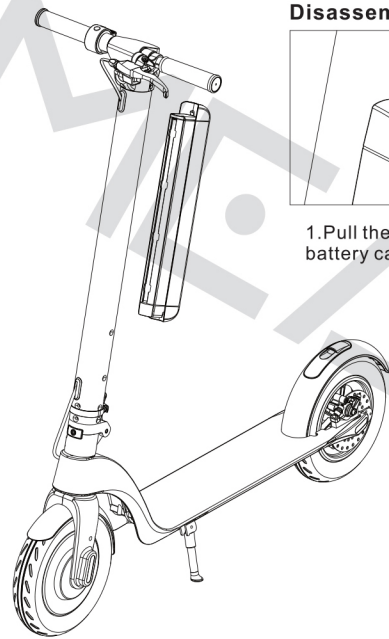

### Disassembly

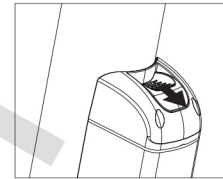

1. Pull the lock on the battery case.

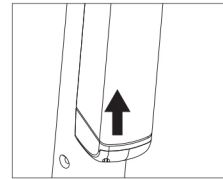

2. Push the battery up from the bottom.

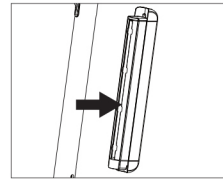

3. After pushing the battery up, then pull it out horizontally.

### Install

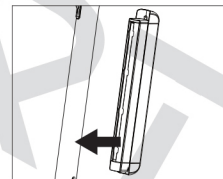

1. Insert the battery horizontally into the pole.

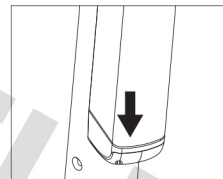

2. Push down until the lock latch of the battery box is tightened.

### 3 How to ride the scooter

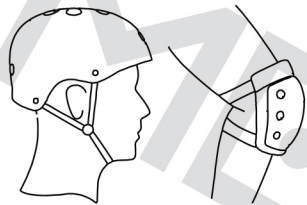

Wear helmets and other protective equipment before riding;

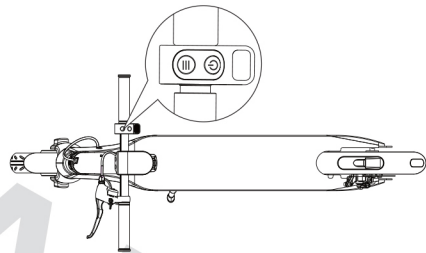

1. Press the POWER button for 2 seconds.



2. Put one foot on the pedal,  
Push off the ground with your strong leg.

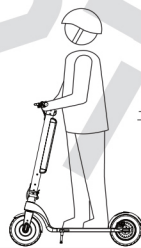

3. Balance both feet on your scooter  
when you have enough momentum.

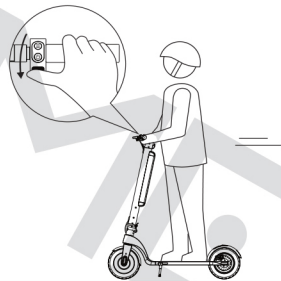

4. Press the throttle button slightly on your right  
hand to start and rotate the handle to turn.

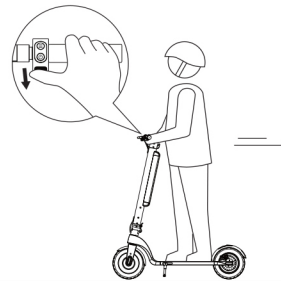

5. Continuously press throttle to  
speed up.

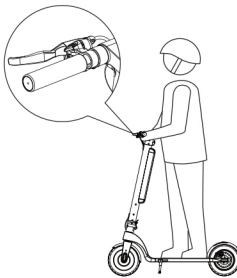

6. Grasp the brake handle to slow  
down or stop.



7. When the scooter stops or run at  
a slow speed, you can get off.



## 4 Battery Instruction

The instruction shows how to charge and maintain the battery, some safety notices and the specification. Please use the battery properly according to this instruction to prolong the battery life and its performance.

### 4.1 Battery Parameters

Name	Parameter	Name	Parameter	Name	Parameter
Type	Li-ion battery	Working Temperature	0°C-35°C	Store Time (-10°C-40°C)	3 months (full charge)
Charging Time	5-7 hours	Charging Temperature	0°C-35°C	Initial Volume	7.8Ah/10Ah
Voltage	36V	Max Charging Voltage	42V	Max Charging Current	2A

### 4.2 Battery Safety

**Do not continue to use the battery when the following conditions occur:**

- The battery of the electric scooter should be used only with local law. Only for professionals to disassemble and maintain the battery.
- Odor or excessive heat; leak any substance; do not touch anything leaking from the battery.
- Do not let children and animals touch the battery. Must unplug the charger before installing the battery or riding. In the case of charging, it is very dangerous to do anything related to electric vehicles.
- If you want the electric scooter to run most efficiently, the battery must be charged and used within the temperature range indicated in the battery specifications.
- Lithium batteries are considered dangerous and require local law to allow transportation.
- The battery contains dangerous substances. Please do not open the battery. Do not insert anything into the battery.
- It is forbidden to charge a lithium battery that has been over-discharged. A battery that has been over-discharged has a safety hazard and can only be scrapped.

**Tip: When the internal temperature of the battery exceeds 45 °C, the battery is protected.**

⚠ Do not charge the battery at high temperature (45 ° C) or Charge the battery in a high temperature (40 ° C) environment.

⚠ Only use the original charging equipment to charge the electric scooter.

### 4.3 Charging step

- Open the charging port cover, Make sure the charging port is clean and dry.
- Connect the charger with the battery and the other end with power(100V-240V;50/60Hz), make sure the charging indicator is on.
- When the charger indicator is red, it will charge normally. Otherwise, please check if the plug is connected properly.
- When the charger indicator is green, charging is complete.

#### Charging method:

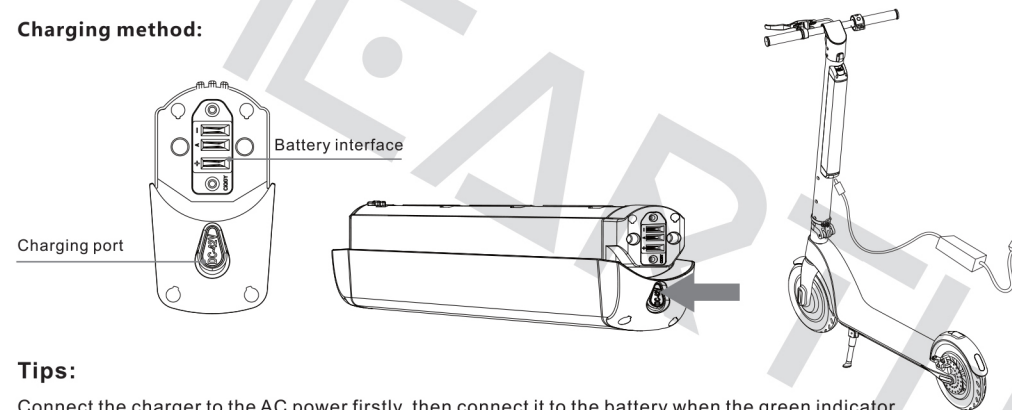

#### Tips:

Connect the charger to the AC power firstly, then connect it to the battery when the green indicator light is normally on.

**After charging, cover the dustproof rubber to prevent something from entering the charging port and causing battery failure.**

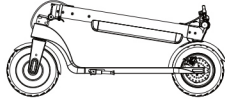
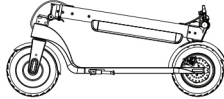

## 5 Specification

Item	8.5 inch	10 inch
<b>Product</b>		
<b>Scooter Specification</b>		
Unfolded size	1073*401*1176mm	1083*401*1186mm
Folded size	1073*401*450mm	1083*401*460mm
Height from pedal to ground	110mm	115mm
Net weight	14.5kg	15kg
<b>Basic Information</b>		
Capacity	36V/7.8Ah or 10Ah	36V/7.8Ah or 10Ah
Moto power	36V/350W	36V/350W
Mileage per charge	30-45km	30-45km
Max speed	20km/h	20km/h
Max loading	100kg	100kg
Climbing angle	15°	15°
<b>Charger Specification</b>		
Input voltage	100-240Vac	100-240Vac
Frequency	50-60Hz	50-60Hz
Output voltage	42V	42V
Output current	2A	2A
Store temperature	-10°C-35°C	-10°C-35°C

## 6 Maintenance

### Maintenance considerations :

- Make sure the electric scooter charger and charging line are disconnected and ensure that the electric scooter is off.
- Wipe the shell with a soft cloth to clean the electric scooter. Please don't put more lubricating oil on bearing when you do the maintenance for it.

### ⚠ Warning

- It is forbidden to clean electric scooters by using water cannon or soaking in liquid. This will cause permanent damage of the electronic devices in the host.

### Storage

- Please charge your electric scooter before storage, for preventing the battery from discharging too long time. Please ensure charge at least once every three months.
- If the storage environment temperature is lower than 0 °C, please don't charge electric scooter. Please put it in inside environment temperature (above 10 °C) and then charge, storage temperature is - 10 °C to 35 °C.
- Please keep the electric scooter in a suitable place indoor, dry and appropriate temperature. You can mask the electric scooter to prevent from the dust.

### ⚠ Warning

- In order to protect the user's safety, the user can not take apart the electric scooter, otherwise, the user will give up the maintenance warranty rights of the product automatically.
- Rider must do regular maintenance and servicing for the electric scooter at least every three months. Every time before riding, rider must make sure all the screws are tight and secured, no parts are loose and must make sure the scooter is functioning as it should be before you ride.

## 7 Trouble shooting

Please contact the sales office or the dealer with no hesitate for repair when the electric scooter fails to ride normally.

Description of adverse phenomena	Solution
unable starting up	Check to see if the battery is powered
can not charge	1.Check whether the plugboard has electricity ; 2.Check the charger whether connect AC plug (the light whether is on); 3.Check the plug of the charger and the charging port of the whole scooter have been inserted correctly.
No horn, no blue tooth signal	Check the bluetooth switch whether turn on.

## 8 Packing List

### Electric scooter packing list:

E-scooter: 1PC

Charger: 1PC

Manual: 1PC

Screws & Wrench: 1set

Please contact us with no hesitate if there is any breakage or missing when you open package. We will replace it for you as soon as possible.

**Have a nice day!**