

novita

BH90

Instruction and Installation Manual



Contents

Safety Instructions	2 ~ 6
Grounding Instructions	7
Operational Instructions	8
Parts and Accessories	9 ~ 11

Before using the product

Installation Instructions	12 ~ 14
Installation Checklist	15
How to install remote controller	16
How to install in a public toilet	17

How to install

Using the Remote Controller	18 ~ 24
Using the Main Unit Control Panel	25 ~ 26

How to use

Product Care	27 ~ 28
Cleaning the Nozzle	29 ~ 30
Preventing Freezing	31 ~ 32
Flashing Warning Lamp	32
Troubleshooting	33 ~ 34
Specifications	35

Before making a service call & How to take care of the product

Imported by:
Hygiene For Health®
71 Ruths Place, Suite 8
Sequim, WA 98382
800-681-0753 Fax 360-681-4029
www.advancedtoiletseat.com

Safety Instructions

Be sure to observe the following

- To prevent injury and/or property damage from using the product, be sure to read the following safety instructions carefully and use the product only as instructed.
- Fully understand each of the following symbols (marks and graphical signs). Read and observe all associated instructions and precautions.

 WARNING Failure to observe the following warnings might result in serious injury or death.	 CAUTION Failure to observe caution information might result in minor injury and/or product damage.
 Strictly prohibited actions.	 Be sure to unplug the electric power plug.
 Never disassemble or modify this product.	 Do not place in or drop into water.
 Be sure to ground the unit properly to prevent electric shock.	 Required actions.
 Never use the product with wet hands.	

- ⊠1: Serious injury includes loss of eyesight, severe wound, burn (high, low temperature), electric shock, bone fracture, poisoning, etc. leaving after effects which may require hospitalization or regular long term care.
- ⊠2: Injury means a minor wound, burn or electric shock that does not require hospitalization or regular long term care.
- ⊠3: Property damage refers to extensive damage to dwelling, furniture and other possessions, livestock or pets, etc.

Exemption from liability

- Manufacturer takes no responsibility for any damages resulting from natural disasters such as earthquakes, lightning and wind damage and flooding, fires not caused by the manufacturer or the bidet product covered by this manual, other accidents, consumer mistakes and/or misuse and abuse of the product or the use of the product under abnormal condition.
- Manufacturer takes no responsibility for any incidental damages resulting from the use of the product or inability to use the product (lost profits or suspension of business, etc.).
- Manufacturer takes no responsibility for any damages resulting from the failure to observe the contents contained in this manual.

WARNING

Set the seat temperature adjustment button to OFF when the product is used by a child, the elderly, or persons with applicable disabilities.

Kids, the elderly, people with sensitive skin, people incapable of adjusting temperature on their own, people who have taken sleep-inducing medicine (sleeping pill or cold medicine, etc.) or people with hangover or severe weariness may sustain a low temperature burn or injury.

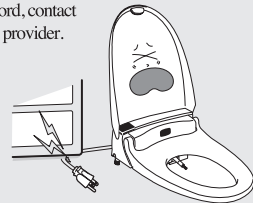

Do not damage or excessively bend, twist, or pull on the electrical power cord. Do not expose it to heat or place heavy objects on the cord.

A damaged power cord could cause fires or electrical shock. Do not attempt to replace a damaged power cord. To replace a power cord, contact an authorized service provider.

This product should only be used with 220 V 10 A electrical current and plugged into a stationary power outlet. Use of a multi-prong outlet adapter or extension cord with this product may lead to overheating or fire.

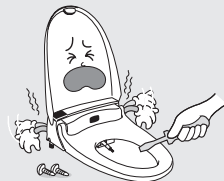

Never disassemble, repair or modify the product. Doing so may cause fire, electrical shock or injury. Contact an authorized service provider for repairs.

Never use a damaged power cord, damaged power plug, or a loose electrical outlet.

Doing so may result in fire, electric shock, short circuit, smoke generation or ignition.

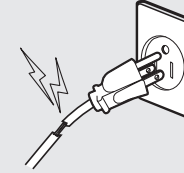

Plug the power cord securely into a wall outlet.

Failure to do so may result in electric short circuit, electric shock, smoke generation or ignition.

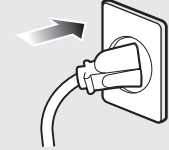

Disconnect the power cord from the wall outlet and drain water from water reservoir before extended period of disuse.

If not drained, the water may be contaminated.

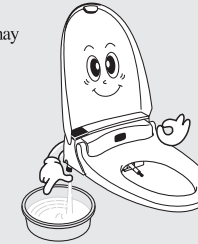

Do not get water on the product. Do not install the product in wet or damp locations. (This product is intended for use on toilets only.)

Using the product for any other purpose could result in electric shock, short circuit, or fire.

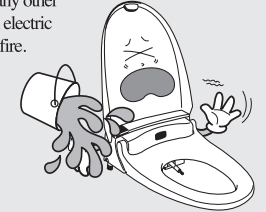

Use tap water or drinking water only.

Using recycled water or industrial water may cause cystitis or skin irritation.

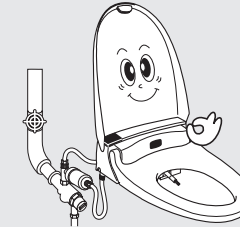

Do not spray water or wastewater into the unit or power plug.

Doing so may cause fire or electric shock.

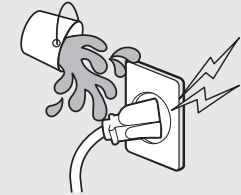

Keep the power plug dust-free by removing the dust using a dry cloth.

Failure to do so may cause a fire.



Never use wet hands to plug or unplug the power cord.

Doing so may lead to electric shock.

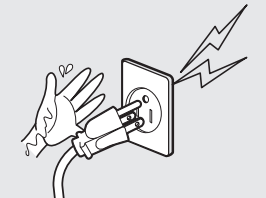

Always disconnect the power cord from the wall outlet before cleaning the product.

Failure to do so may result in electric shock or injury.

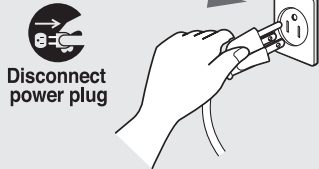

Discontinue using the product if it malfunctions. Unplug the power cord from the electrical outlet and close the water valve if any of the following occur.

- ☒ Water leaks from either the main unit or water lines.
- ☒ The product emits an unusual noise or odor.
- ☒ The product is unusually hot.
- ☒ The product is cracked or broken.
- ☒ The product emits smoke.

Continued use of a malfunctioning product mentioned above may lead to fire, electric shock, or water leakage. Contact an authorized service provider for repairs.

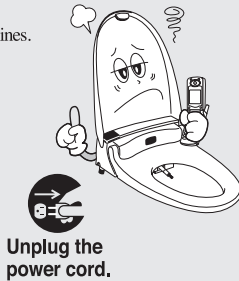

Only use genuine water filters provided by the manufacturer.

Prohibited

Safety Precautions

⚠ CAUTION

Use this product only as instructed in this manual. Failure to do so may lead to fire, electric shock or injury.

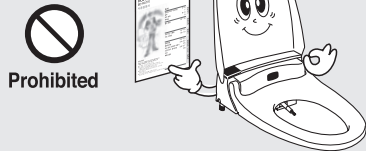

Prohibited

Never unplug the cord by pulling on the cord. To unplug the cord, grip the plug firmly.

Failure to do so may result in electric shock, electric short circuit or fire.



Unplug the power cord.

Do not place or use the product near fire sources, such as stoves, heaters, or lit cigarettes. Doing so may lead to fire, discoloration or malfunction.

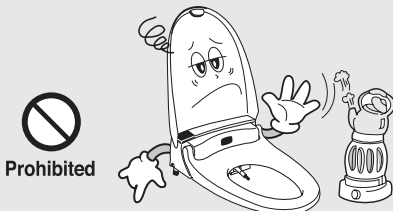

Prohibited

Do not lean against the seat cover when sitting on the seat.

Doing so may cause the seat cover to break, which could even lead to the back injury if the user loses their balance and falls over.

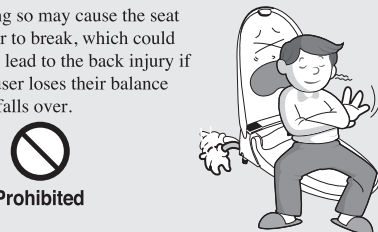

Prohibited

Do not insert fingers or any other objects into the warm air blower outlet.

Doing so may result in burn or injury.



Prohibited



Do not let children use this product unsupervised. Doing so could result in the child falling into the toilet bowl.

Children must be supervised by an adult.



Prohibited



Do not insert fingers or other objects into the warm air outlet, nozzle port, or path of the water spray.



CAUTION

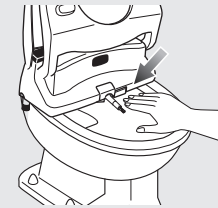

Only press control panel buttons when the seat is occupied.

Otherwise, a person standing by the product or the floor may get wet from water emitted from the nozzle.



CAUTION

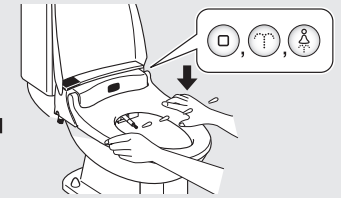

Close the water valve before removing the filtering mesh for cleaning.

Install the mesh securely and make sure there is no leakage after cleaning.

Failure to observe may lead to water leakage. (See page 28 for cleaning of the filtering mesh.)



Close

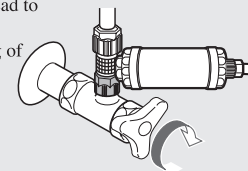

Never expose the product to direct sunlight. Doing so may cause surface discoloration or other product deterioration.



Prohibited

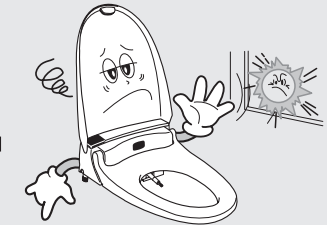

Do not pull excessively or apply other excessive forces on the water feed hose.

Doing so may cause water to leak.



Prohibited

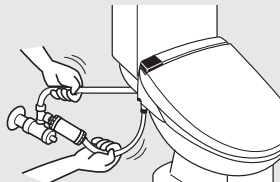

Do not stand on the main unit or expose it to impacts.

Doing so may lead to deformation or breakage of the product and could additionally result in injury.



Prohibited

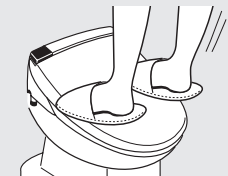

GROUNDING INSTRUCTION

Never use acidic or alkaline toilet detergents, benzene, paint thinners, cleansers, or nylon scrubbers when cleaning the product.

Doing so may damage plastic or metallic parts.



Prohibited



Always keep the ambient temperature above 32°F (0°C) by using a heater in locations where freezing is likely to occur. If freezing occurs, it may result in breakage of water pipes, causing water to leak. If freezing is highly likely to occur, drain the water from the warm water reservoir.



Never place unit in water

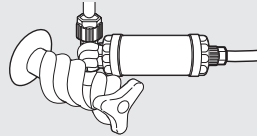

Do not place or drop the product in water.

Doing so may lead to product failure or electric shock.



Never place in water

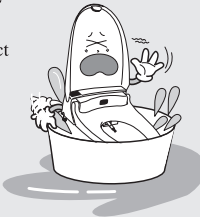

Do not insert fingers or other objects into deodorization cassette housing.

Doing so could result in injury in the fingers due to rotating deodorization fan.



Prohibited

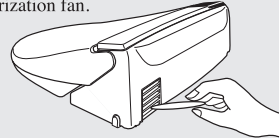

CAUTION for usage

The user of this bidet product should not weigh more than 264.5 lbs(120kg).



CAUTION for usage

Persons with a skin disorder or other medical conditions in applicable areas should consult a physician before using this product. This product is not a medical device.



CAUTION for usage

The water pressure should be set to Low or Very Low if used by persons with sensitive skin or medical conditions in applicable sensitive areas, the elderly, or persons with applicable disabilities. Failure to do so may lead to skin damage.



CAUTION for usage

Use genuine water filters only. The manufacturer is not responsible for any problem resulting from using other filters.



CAUTION for usage

Before removing and relocating the product, be sure to close the water supply valve, unplug the power cord, disconnect the water hose, drain the residual water from inside the product, and wrap the product to protect it during relocation

☒ If the product is moved with water still inside the main unit, leakage from the water reservoir may cause electric shock, fire or product failure. Refer to page 31 of this manual regarding draining residual water.

☒ For details, contact the dealer where the product was purchased or an authorized service provider.

1. This product should be grounded. In the event of an electrical short circuit, grounding reduce the risk of electric shock by providing an escape wire for the electric current. This product is equipped with a cord having a grounding wire with a grounding plug. The plug must be plugged into an outlet that is properly installed and grounded.

Danger—Improper use of the grounding plug can result in a risk of electric shock.

If repair or replacement of the cord or plug is necessary, do not connect the grounding wire to either flat blade terminal. The wire with insulation having an outer surface that is green with or without yellow stripes is the grounding wire.

Check with a qualified electrician or serviceman if the grounding instructions are not completely understood, or if in doubt as to whether the product is properly grounded.

2. This product is for use on a nominal 120 V circuit, and has a grounding plug that looks like the plug illustrated in sketch A in Figure 1. A temporary adapter, which looks like the adapter illustrated in sketches B and C, may be used to connect this plug to a 2-pole receptacle as shown in sketch B if a properly grounded outlet is no available. The temporary adapter should be used only until a properly grounded outlet (sketch A) can be installed by a qualified electrician. The green colored rigid ear, lug, and the like extending from the adapter must be connected to a permanent ground such as a properly grounded outlet box cover. Whenever the adapter is used, it must be held in place by the screw.
3. If it is necessary to use an extension cord, use only a three-wire extension cord that has a three-blade grounding plug, and a three-slot receptacle that will accept the plug on the product. Replace or repair a damaged cord.

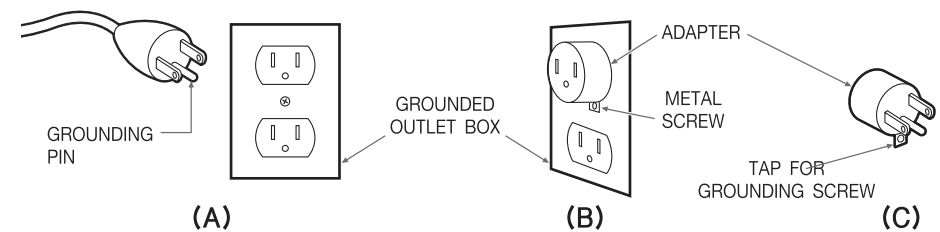

Figure 1.

Operational instructions

Do not tighten the ball valve connecting screw when connecting or disconnecting the water feed hose. Doing so could interrupt water supply to the toilet water tank.

Do not touch ball-tap connecting screw.

In cold regions, have a qualified plumber install a hot water feed pipe and the flush valve.

Keep any unused water hoses for future use.

Do not use excessive force to open/close the toilet seat or cover.

Doing so could result in breakage or malfunction.

Steam or moisture condensation on the seat sensor window could cause malfunctioning.

Water may keep running out of the nozzle after cleansing, but that does not indicate an abnormality. It is from residual water in the flow lines and will stop after 2 minutes.

Fully drain water from the warm water reservoir to prevent possible water leakage and unplug the power cord before extended periods of disuse.

If the main unit becomes dirty, wipe it with a soft cloth.

If especially dirty, wipe it with a diluted neutral detergent using soft cloth and then wipe off any residual detergent with a damp cloth.

Install the remote controller in a location where the signal can easily reach the signal receiver.

The remote controller may not operate properly if things like curtain are in between the controller (transmitter) and the receiver.

Deodorization will stop automatically after 15 minutes of continuous use. Please stand up and sit again for longer use.

The main purpose of deodorization is to deodorize the toilet bowl. It is not intended for the whole bathroom.

No cleansing water may be emitted from the nozzle if the water pressure is set to low in regions with low tap water supply pressure.

In such cases, set the water pressure setting to "high."

Do not use excessive force to press buttons on the control panel.

Doing so could cause malfunction.

The timer automatically stops the cleansing after about 2 minutes of continuous use.

Press the button again for further cleansing.

Keep the nozzle and warm air blower outlet clean to prevent possible staining or malfunction due to urine.

Keep the nozzle clean from contamination to prevent odors and malfunction.

The remote controller may not function properly if the signal receiver is exposed to direct or inverter-type fluorescent light.

In such cases, remove the remote controller from the holder and use it while holding in the hand.

Never place the remote controller near a stove or drop or immerse it into water.

Never drop the remote controller into toilet bowl. Doing so could result in malfunction.

The remote controller may not function properly if curtains or other obstructions are located between the controller (transmitter) and the receiver.

Descriptions of each part and accessories

Numbers inside the arrow sign indicate the pages where the corresponding parts appear.

Front side of main unit

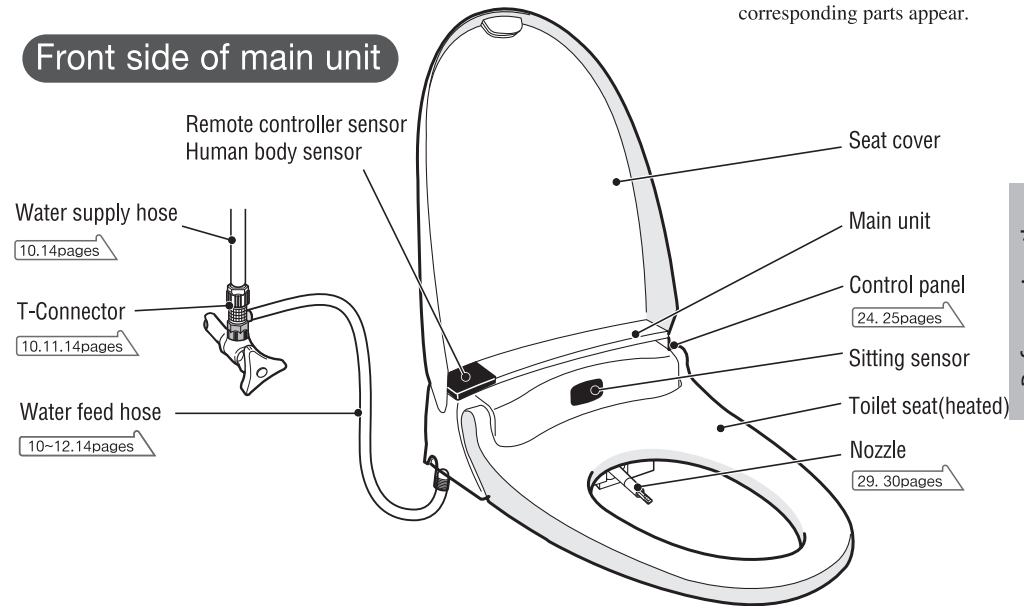

Rear side of main unit

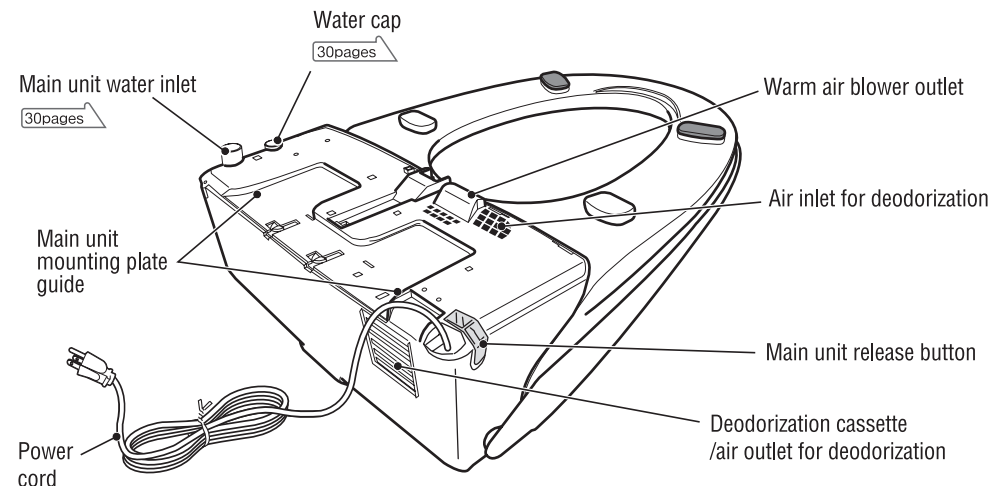

Before using the product

Control panel

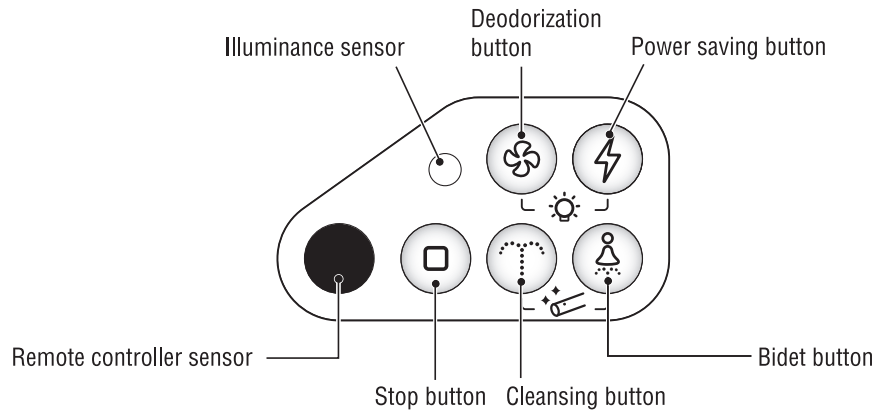

- ※ (Mood lamp): Press and hold for more than 3 seconds both deodorization and power saving buttons at the same time.
- ※ (Nozzle cleaning): Press and hold for more than 3 seconds both cleansing and bidet buttons at the same time.

Back side of remote controller

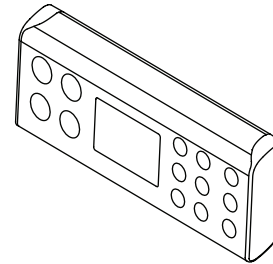

Remote controller holder

The holder in which remote controller is kept is attached to the wall.

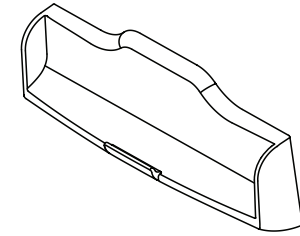

Accessories

Items required for installation

<p>Mounting bolt</p>	<p>Mounting plate 2pcs</p>	<p>Water tank hose 13.7in(0.35m) 1pc (includes packing)</p>	<p>Water feed hose 19.6in(0.5m) 1pc (includes packing)</p>	<p>Brush for cleaning 1pc</p>	<p>Water filter 1pc (Optional)</p>
<p>Hemisphere packing</p>	<p>Mounting plate guide 1pcs</p>			<p>T-connector 1pc Packing 1pc</p>	<p>Deodorization filter 1pc</p>
<p>Washer</p>					
<p>Nut</p>	<p>Mounting bolt set 1 set</p>				

Items required for installation of remote controller

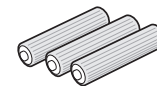

Three AA batteries 1.5V



2 pieces of double-stick tape

Remote controller control panel

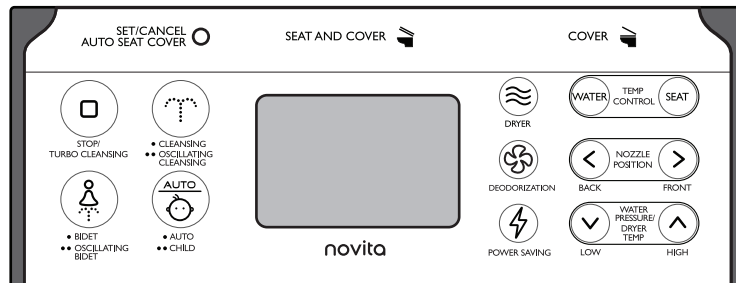

Installation Instructions

1 Close the water valve.

- Check if any other appliance is being used with the water before closing the valve.

Note

- Check any nearby faucet to confirm that the water is shut off.

2 Remove the existing toilet seat.

- Remove the seat by untightening the nuts using a tool.

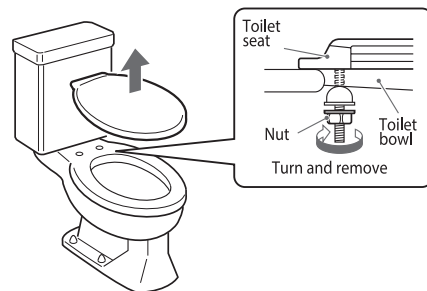

Note

- Keep the removed seat, seat cover, nuts, and so on in a safe place for possible future use.

3 Install the T-connector.

- Use a standard internally threaded T-connector.

1. Connect the T-connector to the toilet water tank.

- CAUTION** • Overtightening could result in damage.

2. Connect the water tank hose between the T-connector and the water valve.

- CAUTION** • Water leakage may occur if a gasket is not used in the connections.

- Hold the T-connector firmly when connecting the hose so the T-connector does not rotate.

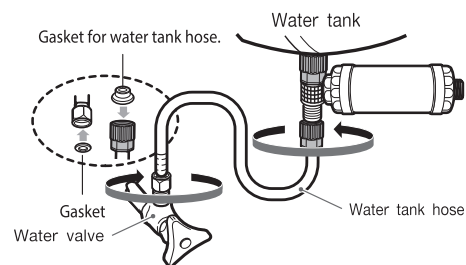

3. Connect the (optional) water filter to the T-connector.

- The service life of the water filter is about 6 months.
- Use a genuine water filter only. The manufacturer is not responsible for any problems resulting from using any other filters.

4. Connect the water feed hose to the water filter.

- Check that the hose connection includes a gasket before connecting.

Installation Instructions

4 Connect the water feed hose to the main unit.

- Check before connecting the hose to make sure there is a gasket in the hose joint.
- Water leakage may occur if the gasket is not used.
- Before attaching the water feed hose, check to make sure the filtering mesh is attached to the main unit water inlet.

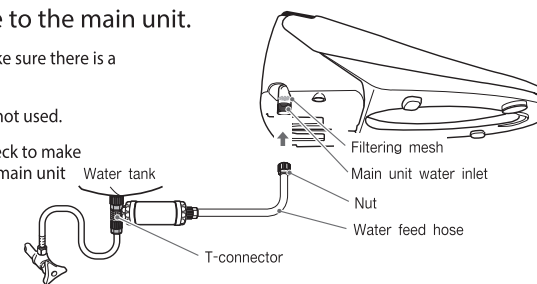

5 Install the main unit.

1. Remove the bolt grommets, washers, and nuts from the mounting bolts and insert the mounting bolts through the mounting plate.

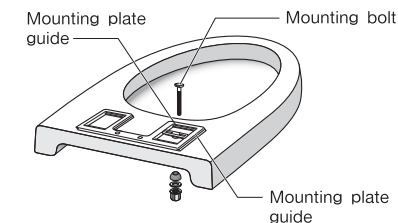

2. The head of the mounting bolts should come in direct contact with the mounting plate.

3. Insert mounting bolts through the toilet bowl holes while aligning the bolts with the holes. Then install the grommets, washers, and nuts, in that order.

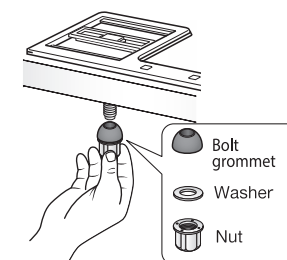

Note

- Threaded bolts may loosen with time. If loose, retighten the nuts.

- CAUTION**
- ① The distance between the bolts can be adjusted, from 130 mm to 200 mm, depending on the hole locations of the toilet bowl.
 - ② Attach and fasten the main unit by carefully aligning the center of the main unit with the center of the toilet bowl.
 - ③ Use the wrench provided with the bidet for tightening the nuts.

Installation Instruction

- Align the center of the main unit with the center of the mounting plate guide and push the unit all the way until it clicks.

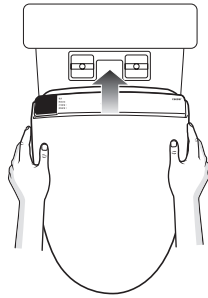

- Confirm that the main unit does not come off easily by moving the unit in four different directions.

• When the main unit is installed to the toilet bowl, it may be slightly movable, which does not indicate an abnormality. This is normal for removable models.



Note

• If the main unit movement becomes significant over time due to loose bolts, retighten the bolts.

Installation Checklist

Checking water leakage

Check carefully if water leaks from pipe joint or any other parts after the product installation.

Inspection items

- Check if all the packing were used in the installation. If there is any packing left, check where it is missing, disassemble the joint where it is missing and properly use it.
- Check if there is any loose connection or joint before feeding water. If there is any loose connection, tighten using a spanner.

1. Open water valve.
2. Open water feed valve and check if water leaks from any pipe joints.

If water leaks,

1. Close water valve.
2. Disassemble the joint where water is leaking and connect properly again.

Note

- If water continues leaking, close water valve and contact a nearest authorized service center.

→ : Points of inspection for water leakage

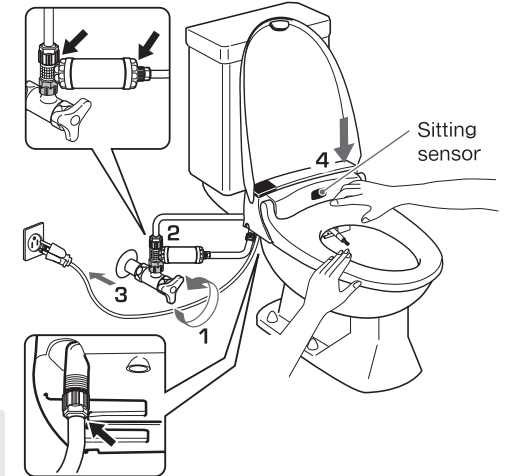

Check product operation

Check the operation of the product in the following order.

1. Open water valve (if closed).
2. Open water feed valve with a blade type screwdriver (or with hands if it is lever type.)
 - Check if water leaks from pipe, water tank hose or water feed hose joints.
 - If water leaks, close the water feed valve, separate the valve and check if rubber packing is inserted.
 - If not, insert the packing and reassemble the water feed valve.
3. Connect the power plug to the wall outlet.
 - Nozzle extends and retracts once, and the control panel lamps keep blinking (at initial operation.)
4. Approach the hand to the sitting sensor (within 1.9 inch (5 cm)) so that the sitting sensor may be activated.
 - Deodorization fan operates which indicates that the sitting sensor has been activated.
 - There is water around nozzle which indicates that water is inside the tank.
5. Press cleansing button.
 - Check if nozzle extends and water comes out from the nozzle. Use hands to prevent water from splashing around.
6. After confirming that warm water is coming from the nozzle, separate the hand from the sitting sensor or press stop button so that the operation may be stopped.
 - Cleansing operation stops and nozzle retracts.

How to install remote controller

1 Insert two AA batteries.

1. Take out the remote controller from the remote controller holder and open the battery cover on the back side.
2. Insert two AA batteries (1.5V) while paying attention to \oplus, \ominus signs.
3. Close the battery cover.

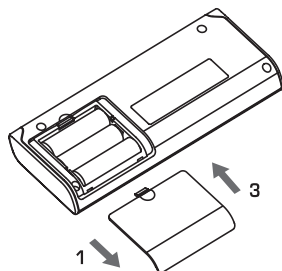

2 Install the remote controller on the wall.

1. Attach the double-stick tape on the back side of the holder. Red side of the tape should be visible.

☒ Once the holder is attached to the wall, it is difficult to remove. Therefore, it is recommended that the proper location for the remote controller to be installed should be determined before the holder is attached on the wall.

2. Thoroughly clean the area on the wall where the holder is located, remove the red cover from the double-stick tape and attach the holder to the wall.

☒ Signal can be better received by the receiver if the remote controller holder is located as close as possible to the main unit control panel.

3. Put the remote controller into the holder, press the dry button on the remote controller while the sitting sensor is activated and check if the product operates normally.

☒ In the event that the product does not operate normally, the remote controller holder has to be relocated to another place where the remote controller normally operates.

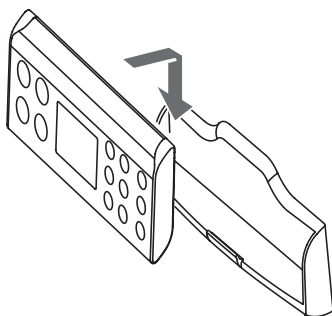
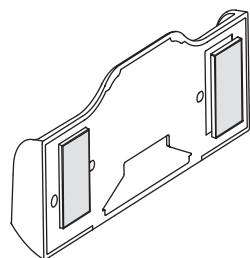

3 Put the remote controller into the holder.

- ☒ Check and confirm if the remote controller is properly installed in the holder.

How to install in the public toilet

This page provides the installation instruction in the event that several bidet products are installed in the public toilets such as those in hotel, shopping mall or the school, etc. where several toilet bowls are installed in a row. If the product is installed in a private usually residential toilet room, instructions in this page do not apply.

※ In case of modification in installation or product settings, contact the authorized service personnel.

Initial setting of remote controller

When the bidet products are shipped out of the manufacturer's factory, any and all remote controllers have the same initial setting. Therefore, if two or more products are operated using remote controllers at the same time in the public toilet room, it may lead to product malfunction unless the remote controller settings are changed. Be sure to change the remote controller setting in the following order. A total of 8 different settings including the initial setting at the manufacturer's factory are available. (Tools that are required; precision screwdriver, nipper)

1 Remove 5 screws from the remote controller and open the back cover.

- Use precision screwdriver to remove the screws.

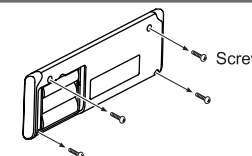

2 Change the mode by cutting jumper wire by using nipper on the circuit board.

- Jumper wire should be cut by cutter at the center, and be careful and pay attention so that wire cut may not get into the main unit. If other jumper wire on the circuit board is cut, it may lead to malfunctioning of the product.

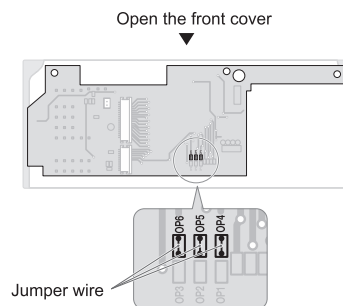

Remote controller setting table

O: No cut X: Cut *: initial mode at the time when the products are shipped out of factory

OP4	OP5	OP6	Mode of setting
O	O	O	0 *
O	O	X	1
O	X	O	2
O	X	X	3
X	O	O	4
X	O	X	5
X	X	O	6
X	X	X	7

Explanation on the table

- In the event that, for example, three toilet bowls are in a row of which remote controller settings are referred to 0, 1, 2 respectively. For the remote controller 0, setting does not have to be changed. For the remote controller 1, jumper wire OP6 is cut. For the remote controller 2, jumper wire OP5 is cut. (In the event that the number of toilet bowls increase, the table may still be used accordingly and jumper wire should be cut based on the table.)

3 Put back the back cover and fix with the 4 screws.

4 Once the setting change of remote controller is completed, set the main unit accordingly.

1. When the stop button is pressed and held for three seconds or more, a beep sounds once.
2. Press the stop button on the remote controller.
3. If beep sounds twice, the setting is completed.

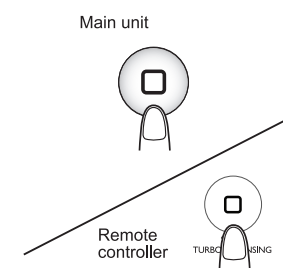

How to use remote controller

Warning



Caution

When the product is used by following person, set the toilet seat heater OFF and pay special attention:

Child, the elderly, person having sensitive skin, person unable to control temperature on his/her own, person having taken sleep-inducing medicine such as sleeping pills or cold medicine, person who has drunken heavily or is exhausted. Failure to do so may lead to low temperature burn or other type of burns.



Warning

Do not shake seat cover or any parts that are connected with toilet seat while seat cover is being opened or closed.

Otherwise it may lead to injury or product breakage.

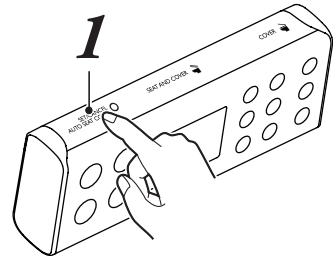

Note

- Use three AA size batteries. If battery display blinks , replace batteries. If remote controller is not operable, use buttons on the main unit control panel.
- LCD panel lamps on the remote controller come on if button is pressed and turn off about 5 seconds after main unit starts to operate accordingly (for the purpose of saving battery power/refer to page 23).
- Unless seat cover is opened and the seat is occupied, turbo, cleansing/oscillating cleansing and bidet/oscillating bidet, or auto/child is not to be operated.
- Seat cover operation (open/close) is under automatic mode when the products are shipped out of factory.

1 How to set automatic seat cover operation.

Setting : Set seat cover switch on the remote controller to "ON".

- Seat cover is automatically opened when a person is near the toilet bowl. If no person is near the toilet bowl, seat cover is closed automatically about 2 minutes later.
- Automatic seat cover operation is made possible to detect the movement of an object within the sensing distance of the main unit.

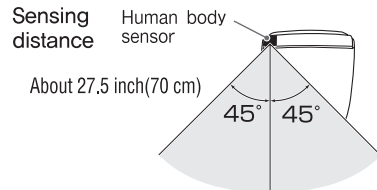

Note

- Be careful so that no water comes in contact with human body sensor.

Caution

1. If sunray from the window or movement of curtain is detected, seat cover may be opened automatically.
2. If movement of any object is detected by sensor, seat cover may be opened.

How to set manual seat cover operation

Setting : Set the seat cover switch on the remote controller to "OFF".

<When using automatic/manual seat cover operation>

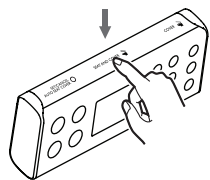

- If [toilet seat/seat cover] button is pressed while toilet seat/seat cover are open, both toilet seat and seat cover are closed.

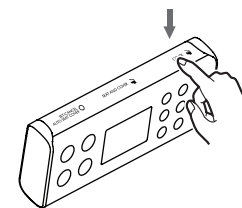

- While seat cover is closed, press [cover operation] button to open it.
- While seat cover is open, press [cover operation] button to close it.

2 Sit down on the toilet seat.

Cleansing can be operated if and when the sitting sensor is activated.

- Under automatic deodorization mode, fan is to operate (fan noise can be heard).

Note

- If user's clothes are too close to the sensor, the sitting sensor may not get activated.



3 Press or button.

- Nozzle is self-washed.
- Nozzle position may be set depending on user's needs by using nozzle position control button.
- If used consecutively for 2 minutes or more, the operation stops. Press the same button again to resume the operation.

Note

- Do not press buttons on the main unit control panel or remote controller too hard. Doing so may cause a failure.

4 Press or button one more time while cleansing or bidet is operating. (Oscillating cleansing/bidet)

- Wider area may be cleansed as nozzle moves back and forth.
- Pressing  or  button one more time will return to the regular cleansing or bidet.

5 Press button to stop the operation.

- Nozzle self-washes for about 7 seconds as it moves back and forth three times.

Note

- If a function is operated for more than 2 minutes, it stops due to activation of timer.
- If cleansing/oscillating cleansing or bidet/oscillating bidet button is pressed right after either operation stops, the function may not operate immediately in some cases. Wait for a while after nozzle cleaning and press the button again.

6 Stand up from the seat.

- Sitting sensor gets deactivated and cleansing is not operable. Under automatic deodorization mode, deodorization stops after one minute.

Note

- Water coming out of nozzle right after cleansing operation does not indicate a product failure.
- If water continues leaking from nozzle, close water valve, disconnect power plug and contact the shop where the product was purchased or service center.

7 Seat cover is closed.

- If seat cover operation switch on the remote controller is "ON", seat cover is closed automatically about 2 minutes after the user is out of the sensing distance. (If toilet seat is open, it will be closed automatically.)
- Toilet seat/seat cover are designed to be operated slowly and smoothly. Never apply excessive force to toilet seat/seat cover, or it may lead to breakage.

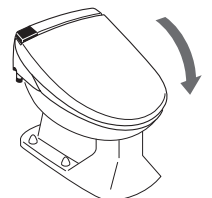

How to use remote controller (continued)

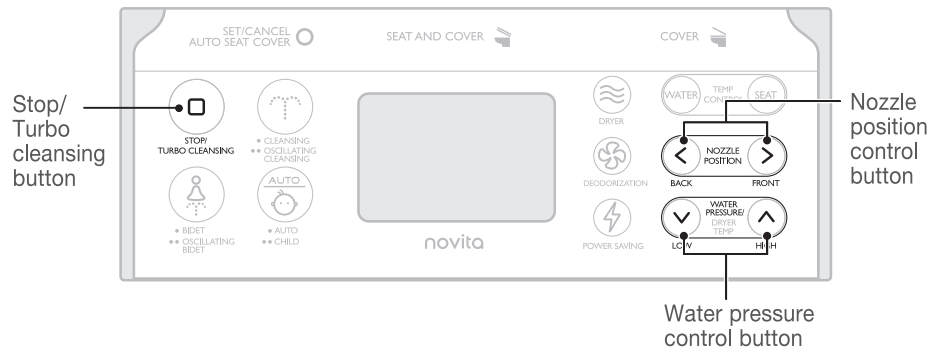



Turbo

Touch  button prior to bowel movement while seat is occupied.

- Warm water is sprayed and the personal area is massaged while nozzle moves back and forth.
- Such operation continues at high water pressure for two minutes.
- Water pressure level can be adjusted during operation.
- If you are ready for bowel movement, touch  button.

Nozzle position control

Touch  or  button during cleansing or bidet cleansing.

- Initial position is the center and the position can be controlled in three positions in forward and three positions in backward.

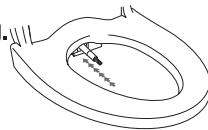

Note

- Nozzle position is not saved in the main unit. Once cleansing is completed, nozzle returns to the original(center) position. Position should be reset the next time.

Water pressure control

Touch  or  button of water pressure/warm air.

- Water pressure can be controlled in four different levels.
- If used at 0.07MPa or lower of water pressure, cleansing operation may not be satisfactory.
- In addition to cleansing water pressure can be controlled in operations of other functions.
- The water pressure level set is saved in the main unit, which will be called the next time the product is used.
- If water pressure is set to LOW in an area of low tap water pressure, cleansing water may not come out. Set the pressure level to HIGH in such case.

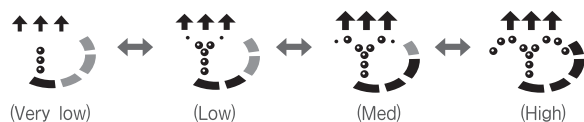

(continued)

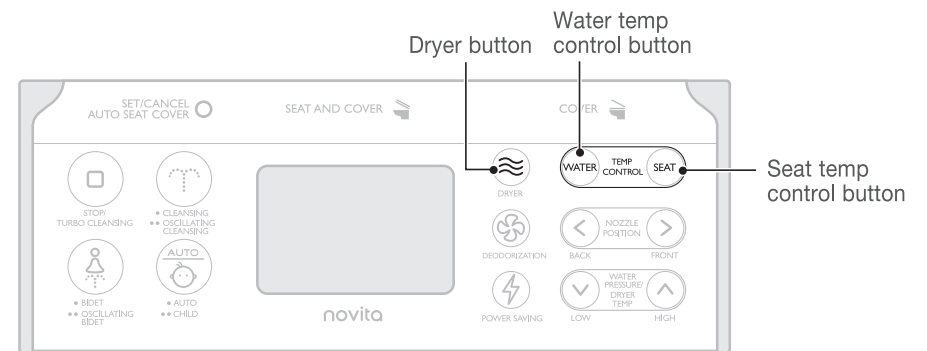

Warm water temperature control button

Touch  of warm water temp. control button part.

- Temperature can be set in four different levels and heater OFF.
- Each time button part is touched, temperature setting is changed.

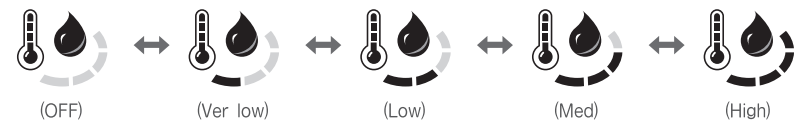

Seat temperature control button

Touch  of seat temperature control button part.

- Temperature can be set in four different levels and heater OFF.
- Each time button part is touched, temperature setting is changed.

Note

- Seat temperature changes depending on the ambient temperature. If the seat cover remains closed when the product is not in use, it will help reduce loss of heat, thus, resulting in reduced electric bill.

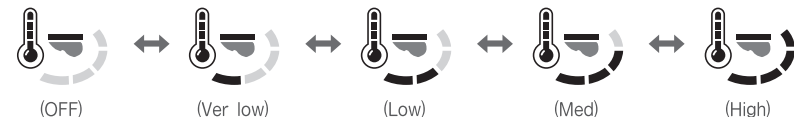

- If the product is used for a long time with seat temp set at HIGH, it may lead to low temp burn. Therefore, seat temperature will lower to about 98.6°F (37°C) after about 10 minutes of seat occupation

Drying

Touch  button part

- Touch  button part to stop drying operation
- Drying stops in about 5 minutes. Touch the button again to resume the drying operation.
- Prior to drying operation use tissue to reduce moistures. It will help reduce drying time.

How to use remote controller (continued)

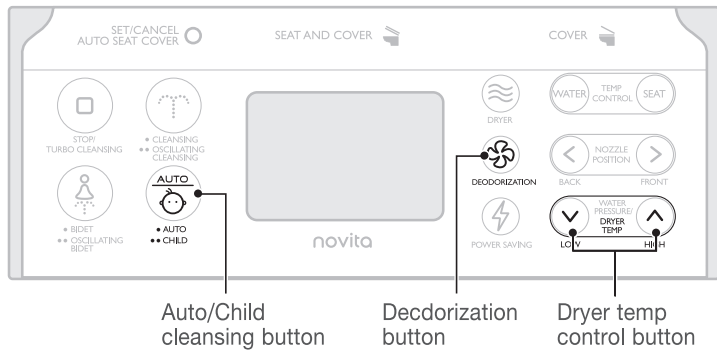

Warm air temperature control

Touch or button of water pressure/dryer temp.

- Touch of water pressure/warm air button part (Air temperature can be set in four different levels and heater OFF).
- When drying is not in operation, air temperature can not be set. Be sure to touch drying button before adjusting air temperature.

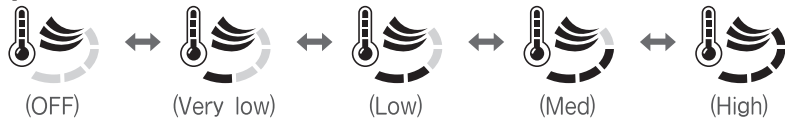

Deodorization

Touch button part.

- of deodorization setting display of remote controller LCD is ON and deodorization operation starts.
- Each time button is touched, setting/cancellation alternates.
- When the seat is occupied, sitting sensor is activated, operating fan and causing deodorization to start.
- When the user stand from the seat, deodorization stops after about one minute.
- If deodorization button is touched during deodorization, deodorization stops, is turned off and the setting is can

Note

- If deodorization is used continuously, it will stop in about 15 minutes automatically. It is designed to remove bad smell from toilet bowl only. It is not possible to remove bad smell from the entire toilet room

Auto/child cleansing

Touch button part once (auto cleansing)

- Two minutes of oscillating cleansing followed by five minutes of drying and stops automatically.
- Water pressure level, water temperature /toilet seat temperature/air temperature saved previously are called automatically.

Touch button part twice (Child cleansing)

- If touched twice consecutively, child cleansing operates and stops automatically.
- Child cleansing (oscillating cleansing of two minutes plus drying operation of 5 minutes)
- Low water pressure level and med level of water/seat/air temperature are called automatically.
- Nozzle position is set at two steps forward from center.
- * Convenient for the elderly or child.

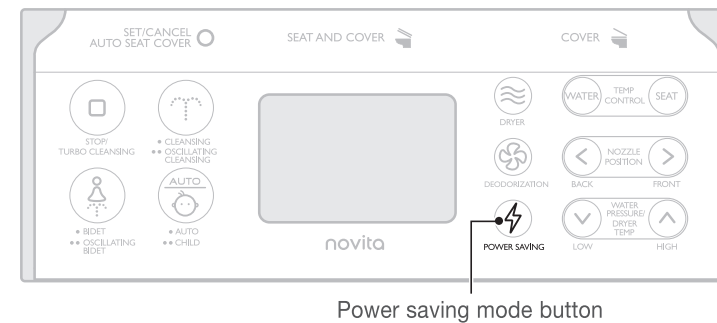

Power saving

Touch button part.

- Each time it is touched, setting is changed as follows. Lo econo-Hi econo-power saving off

- **Lo econo mode (regular mode)**
 - Under lo econo mode as remote controller setting, seat temperature is set to 82.4°F (28°C) regardless of actual setting temperature (power is saved by reducing the time to heat the seat)
 - When the seat is occupied (sitting sensor is activated) seat temperature is raised to the actual setting level (It takes about three minutes, but may vary depending on ambient temperature).
 - If user stands from the seat, the seat temperature is lowered to 82.4°F (28°C).
- **Hi econo mode (timer power saving)**
 - If set to hi econo mode, power saving mode will continue for 8 hours during which time seat heating stops regardless of actual setting temperature.
 - When the seat is not occupied, all lamps except for power saving and power are OFF.
 - When the seat is occupied (sitting sensor is activated) seat temperature is raised to the actual setting level (It takes about five minutes). All lamps except for power saving are ON. When the user stands from the seat, seat heating stops and all lamps except for power saving and power are turned off.
 - When the power saving timer is OFF, power saving function is not offered.

Other power saving tip

- **Setting a lower temperature.**
As long as you do not feel cold, set a lower temperature whenever possible. It will somehow contribute to power saving.
- **Unplug the power plug.**
Disconnect the power plug to reduce power consumption when you go out or when the product is not used over an extended period of time.

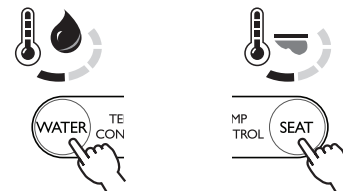

How to use main unit control panel

Warning

- Caution**
- Set the Seat Temp Control Button to "Off" if the product is used by the following person:
 - Young children, the aged or users incapable of adequately setting the temperature,
 - People with sensitive skin and/or skin irritation,
 - People having taken sleep-inducing medicine such as sleeping pill or cold medicine,
 - People suffering from hangover or severe physical fatigue.
 Failure to do so may lead to the low temperature burn or injury.

- Note**
- Cleansing/bidet control can be made while sitting on the toilet seat after the cover is opened.

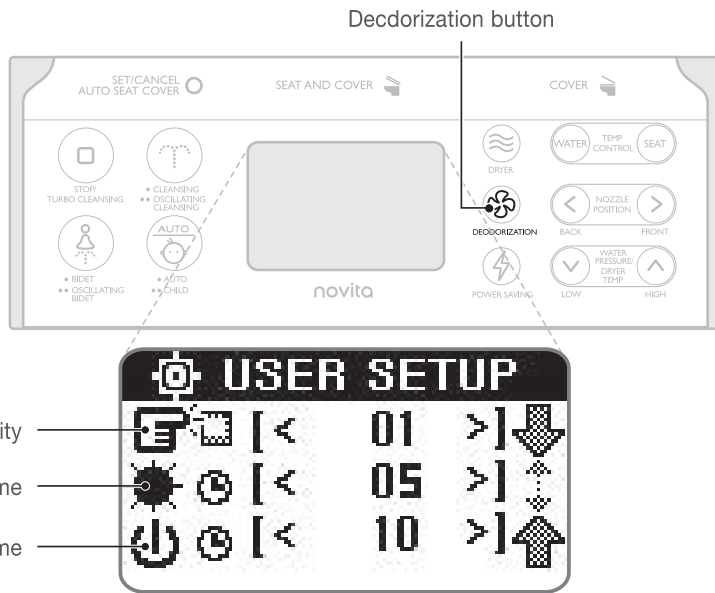

How to set touch sensitivity

- Touch and hold deodorization button part for 3 seconds or longer.**
 - Select 'touch sensitivity control setting mode' while touching "V", "Λ" of water pressure/warm air control.
 - Select touch sensitivity level while touching "<", ">" of nozzle position control.
 - Touch sensitivity can be set in 7 different levels.
 - If stop button is touched, setting screen will disappear and the setting is saved.

How to set LCD lighting time

- Touch and hold deodorization button part for 3 seconds or longer.**
 - Select 'LCD lighting time setting mode' while touching "V", "Λ" of water pressure/warm air control.
 - Select lighting time while touching "<", ">" of nozzle position control.
 - Lighting time can be set for OFF, 3 seconds, 5 seconds, 8 seconds or 10 seconds(for the purpose of saving battery power)
 - If stop button is touched, setting screen will disappear and the setting is saved.

How to set LCD display time

- Touch and hold deodorization button part for 3 seconds or longer.**
 - Select 'LCD display time setting mode' while touching "V", "Λ" of water pressure/warm air control.
 - Select display time while touching "<", ">" of nozzle position control.
 - Display time can be set in 10 seconds, 20 seconds and ON(for the purpose of saving battery power)
 - If stop button is touched, setting screen will disappear and the setting is saved.

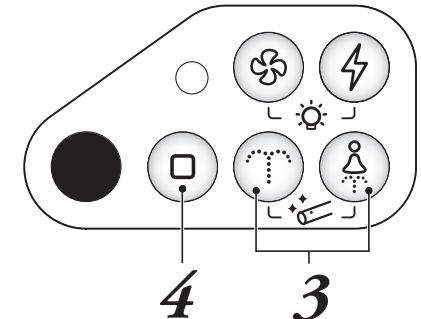

1 Open seat cover by using human body sensor or directly manually.

2 Sit on the seat.
 After sitting sensor is activated and water is detected, cleansing is operable.
 • If deodorization is set, fan will operate.
 • When detecting tank water, much more water than usual may come out for accurate operation.
 Water will not come out if the toilet seat is re-occupied within 30 minutes.

Note

- If user's clothes are too close to sitting sensor, the sensor may not be activated

3 Press or button.
 • Nozzle is self-cleaned automatically.
 • If pressed the second time, oscillating function will operate.
 • Nozzle position may be adjusted in 6 stages by using nozzle position control button on the remote controller. If operated for 2 minutes or longer, operation stops. Press the button one more time to resume operation.

Note

- In order to stop cleansing or bidet operation which started by using control panel on the main unit, do not press stop button on the remote controller. Doing so will start turbo function. Always press stop button on the main unit control panel in such case.

How to use

How to use main unit control panel

4 Press button to stop operation.

- Nozzle is self-cleaned while it moves back and forth three times.

Note

- Continued use of cleansing for more than two minutes will activate the timer thus stopping the operation automatically.
- Operation may not start immediately even if cleansing/oscillating or bidet/oscillating button is pressed after either operation stops. Wait a little while (when nozzle is cleaned) and press the button again in such case.

5 Stand from the seat.

- Under deodorization mode, deodorization will stop in about one minute.

Note

- Water coming out of nozzle right after cleansing operation stops does not indicate a product failure. It stops automatically after residual water in the hose is completely released.

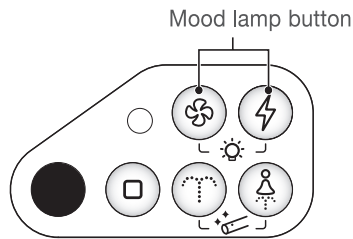

6 Close toilet seat cover.

- Seat and seat cover are designed to be closed slowly. Do not apply excessive force to seat and seat cover, or it may lead to breakage.
- Seat cover will not be closed if automatic seat cover operation mode is not set. Set it to ON with the remote controller.



Mood lamp (💡)

Press and hold both  and  buttons at the same time for more than three seconds.

- Mood lamp is user friendly feature with which the product can be used at night without turning on the toilet room light
- Each time both  and  buttons are pressed at the same time, setting/cancellation alternates.
- Toilet room lighting level is sensed and mood lamp is operated depending on the lighting level sensed.

How to take care of the product

Warning



Disconnect the power plug while cleaning the product.
Failure to do so may cause electric shock or injury.

Caution



Never use acidic or alkaline toilet detergent, benzene, thinner, cleanser or nylon scrubber when cleaning the product.
Doing so may damage plastic or metallic parts.

Main unit

1. Disconnect the power plug from wall outlet.
2. Use a soft and wet (with water) cloth only when cleaning the unit.
3. Clean with a soft and wet (with neutral detergent) cloth if the unit is very dirty, and wipe off the detergent with wet (with water) cloth.
 - Check the detergent type before using the detergent.
 - Seat cover may be separated for cleaning.
4. Connect the power plug to the wall outlet after cleaning is complete.

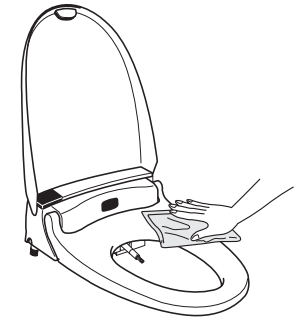

Separation and reassembly of toilet seat cover

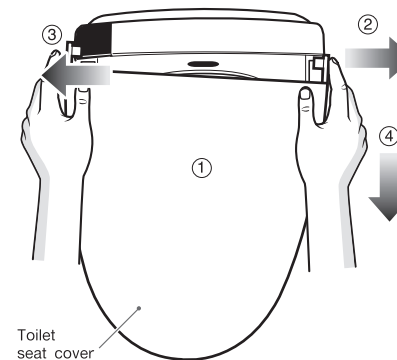

Separation

- ① Close the cover.
- ② Stretch out right side shaft of seat cover.
- ③ Pull out left side of seat cover.
- ④ Remove the seat cover.

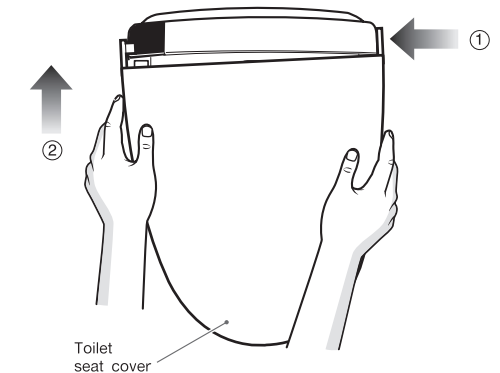

Reassembly of seat cover

- ① Insert seat cover to the right side shaft.
- ② Fit the seat cover into left side of main unit.

Note

- Do not apply excessive force while removing or reinstalling the seat and seat cover. Doing so may damage the rotation shaft, thus preventing easy opening and closing

How to take care of the product (continued)

⚠ Caution

- ❗ Close water valve before removing the filtering mesh. Filtering mesh should be installed securely after cleaning to avoid water leakage. Otherwise it may cause water to leak

Cleaning filtering mesh

- 1 Disconnect the power plug from the wall outlet.

- 2 Close the water feed valve using a blade type screwdriver. (Use hands if the water feed valve is manual type.)

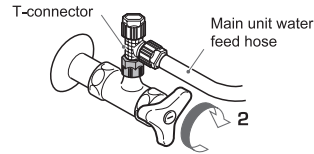

- 3 Separate the water feed hose from the main unit.
 - Be careful so that the floor does not get wet due to water remaining inside the hose.

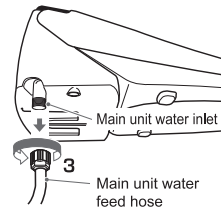

- 4 Clean inside the filtering mesh using toothbrush, etc.
 - The filtering mesh is built in the water feed inlet of main unit.

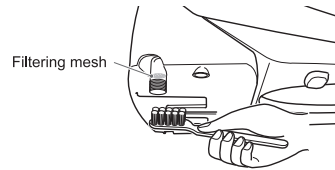

- 5 Connect the water feed hose to the main unit and open the water feed valve.
 - Check if or not water leaks.

- 6 Connect the power plug to the wall outlet.

Nozzle cleaning

- 1 Connect the power plug to wall outlet.

- 2 Open seat cover and toilet seat.

- 3 Press and hold both and buttons at the same time for more than 3 seconds.
 - Nozzle moves back and forth 3 times for self-cleaning and stops moving under fully extended condition

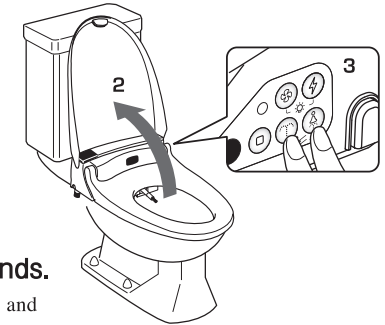

- 4 Clean the nozzle while it is fully extended.

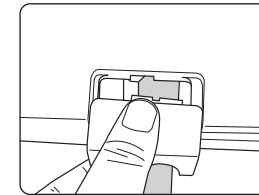

1. Separate the nozzle cleaning cover.

Note

Never use rough brush etc. while cleaning nozzle. Otherwise it may lead to scratch or damage on the nozzle

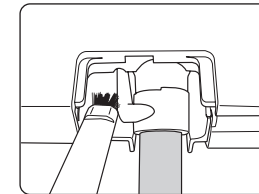

2. Put inside soft sponge, brush, cloth or toothbrush that gets wet with water, and clean.

Note

Be careful so that water may not get into warm air outlet

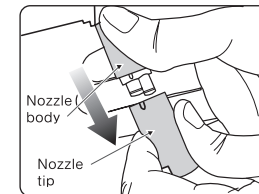

3. Pull nozzle tip from nozzle body while holding the nozzle body and separate the tip

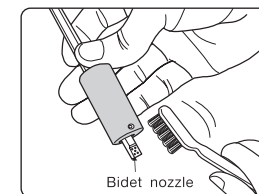

4. Using a tool inside the separated tip, push bidet nozzle so that it may be cleaned with soft sponge, brush or cloth.

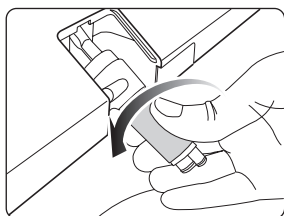

5. Rotate the stainless part of nozzle body counterclockwise and separate the stainless so that it may be cleaned with tooth brush, etc.

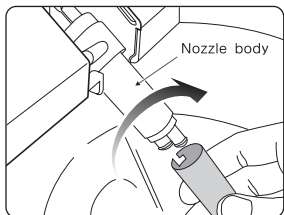

6. To put the stainless part back to nozzle body, rotate clockwise the stainless part with the hole facing downward.

Note

Check if the stainless part may not come off easily.

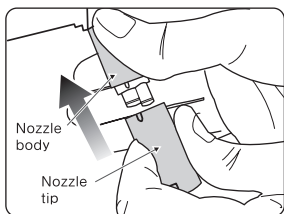

7. Put the cleaned nozzle tip back to nozzle body while holding the nozzle body.

Note

Installation of the nozzle tip without holding the nozzle body may let the nozzle go into the product, so this might cause product breakdown or failure.

Note

- Do not damage the nozzle hole.
- Do not push the nozzle in or pull by force. Doing so may cause a trouble.
- Do not separate and clean the nozzle too often. Doing so may cause a problem.
- Cleansing nozzle tip is assembled a little tightly to secure air-tightness.
- Be careful so that no bodily injury may occur when separating the nozzle tip for cleaning.

5 Press  button on the main unit control panel.

- If you push the nozzle in by force without pressing the button, it might cause a problem.

Note

- After nozzle retracts, there might be some strange sounds which does not indicate product failure.

6 Put back the nozzle cleaning cover and close toilet seat and cover slowly.

How to prevent freezing and to take care of the product when it is not in use over an extended period of time

Remove moisture around the water feed system as freezing may lead to a breakage of the pipe. Remove moisture when the product is not in use for an extended period of time. Water may become spoiled causing skin irritation.

Preventing freezing and long-term care guides if not using product for a long time

1 Unplug the power plug.

- Disconnect the plug from the wall outlet.

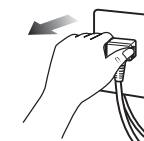

2 Close water valve.

- Use the blade type screwdriver to close the water feed valve. If the valve is manual type, use hands to close the valve.

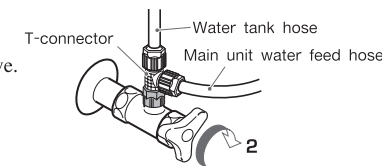

3 Drain warm water from tank.

- Drain warm water from water tank after rotating and removing water cap. Prepare and use a basin with big mouth of which capacity is not less than 0.52 gallon (2 liters) to keep the drained water.
- Put the water cap back after draining water completely from the tank.

* In case that the water cap is not rotated smoothly, use coin etc. to rotate it.

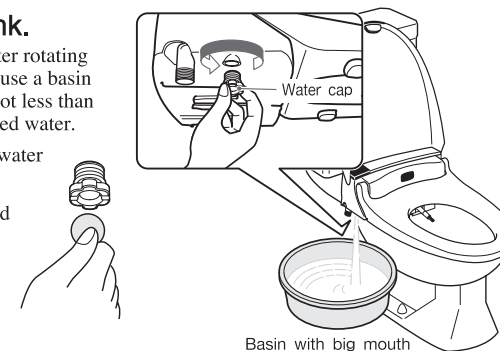

4 Drain residual water from water feed hose.

- Disconnect the water feed hose from the water inlet of the main unit and place the end of the hose in the basin so that water may be contained in the basin.

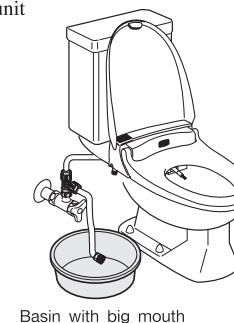
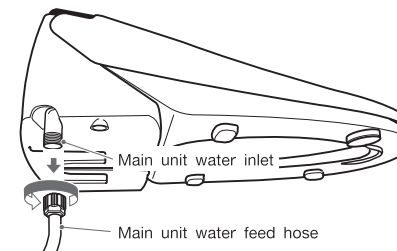





How to cancel the freezing prevention arrangement and to start to use the product again

- 1** Put the water cap back to the water tank.
- 2** Connect the water feed hose as in the installation instruction. (Refer to installation instruction)
 - Check if packing is installed within hose.
- 3** Open the water valve.
- 4** Connect the power plug to the wall outlet.
 - Press Cleansing button to fill the tank with water

Flickering warning signals

The indicating lamp will blink in case of malfunction on the main unit.

Display	Cause of problem and action to be taken
 Power lamp	<ul style="list-style-type: none"> • Problem of water incoming • Water not supplied
 Deodorization lamp	<ul style="list-style-type: none"> • Abnormal seat temperature • Failure to control seat temperature due to malfunctioning seat temperature sensor
 Power saving lamp 1	<ul style="list-style-type: none"> • Problem of incoming water temperature • Failure to control incoming water temperature due to malfunctioning incoming water temperature sensor
 Power saving lamp 2	<ul style="list-style-type: none"> • Problem of outgoing water temperature • Failure to control outgoing water temperature due to malfunctioning outgoing water temperature sensor

Stop using the product, disconnect power plug and contact service center.

Indicating lamp  : blinking

Before making a call for service

Check following before requesting service.

Condition	Cause	Action to be taken
Product does not operate	<ul style="list-style-type: none"> • Check power interruption. • Isn't power plug disconnected? • Isn't remote controller sensor covered with clothes, etc.? 	<ul style="list-style-type: none"> • Wait for power supply. • Connect power plug. • Remove clothes etc.
Nozzle does not move	<ul style="list-style-type: none"> • Isn't sitting sensor activated due to foreign material or moisture, etc.? 	<ul style="list-style-type: none"> • Remove all foreign materials from sitting sensor.
Cleansing water does not come out. (power lamp or power saving lamp 1 is blinking)	<ul style="list-style-type: none"> • Check if water supply is disrupted. • Check if water valve is closed. • Check if water feed hose, etc. is frozen. 	<ul style="list-style-type: none"> • Wait for water supply. • If closed, open the water valve. • Make the frozen part warm using hot and wet cloth. Or keep the room warm by heating. (Do not use hot water or hot air. It may lead to breakage of hose.)
	<ul style="list-style-type: none"> • Check if sitting sensor is properly activated. 	<ul style="list-style-type: none"> • Remove all foreign materials from sitting sensor.
Water pressure too weak	<ul style="list-style-type: none"> • Check if there is foreign material in the filtering mesh. • Check if the water feed hose is bent. • Check if nozzle hole is clogged. • Check if water pressure is set to low. 	<ul style="list-style-type: none"> • Clean the filtering mesh. • Flatten the bending. • Clean nozzle. • Set it to high.
Cleansing water is not warm enough or cold	<ul style="list-style-type: none"> • Check if water temperature is set to heater OFF or low. • Check if the seat has been occupied for a long time. If so, cold cleansing water may come out. 	<ul style="list-style-type: none"> • Set it to medium or high. • Stand up from the seat and sit again before operating cleansing.
Toilet seat is not warm enough or cold.	<ul style="list-style-type: none"> • Check if seat temperature is set to heater OFF or low. • Check if the product is in power saving mode. (Isn't power saving lamp ON?) • Check if the seat has been occupied for a very short time. 	<ul style="list-style-type: none"> • Set it to medium or high. • Power saving mode has been cancelled and the seat will get warm little by little. • Wait for 5 minutes. It will get warm.
Deodorization not in operation	<ul style="list-style-type: none"> • Check if deodorization has been set. 	<ul style="list-style-type: none"> • Press deodorization button to set it.
Deodorization stops in the middle.	<ul style="list-style-type: none"> • Check if the seat has been occupied for more than 15 minutes 	<ul style="list-style-type: none"> • Press the button again if so.
LCD window of remote controller gets dim and LCD settings are initialized (default)	<ul style="list-style-type: none"> • Check batteries. 	<ul style="list-style-type: none"> • Replace batteries.

Specifications

Condition	Cause	Action to be taken
Bad smell not effectively removed	<ul style="list-style-type: none"> Check if there are dusts in the deodorization filter. 	<ul style="list-style-type: none"> If so, take care of the filter.
Main unit is not securely installed	<ul style="list-style-type: none"> Check if the screw bolt is loose. 	<ul style="list-style-type: none"> If so, fully tighten the bolt.
Warm air temperature too low	<ul style="list-style-type: none"> Check if air temperature has been set to heater OFF or low. 	<ul style="list-style-type: none"> Set it to medium or high.
Drying stops in the middle of operation.	<ul style="list-style-type: none"> Check if drying has been in operation for more than 5 minutes. 	<ul style="list-style-type: none"> If so, press the button again.
Deodorization stops in the middle of operation	<ul style="list-style-type: none"> Check if the seat has been occupied for more than 15 minutes. 	<ul style="list-style-type: none"> If so, press the button again.
Low voltage warning is displayed in the remote controller window.	<ul style="list-style-type: none"> Check batteries. 	<ul style="list-style-type: none"> Replace batteries if necessary.
Water leaks from nozzle automatically	<ul style="list-style-type: none"> In case of incoming water temperature of 33.8°F (1°C) or lower, water is discharged hourly for 5 seconds. 	<ul style="list-style-type: none"> This is not a product failure, but freezing prevention arrangement.

* The time required for heating may vary depending on ambient temperature.

Actions to be taken during power disruption

In the event that the power plug is disconnected and connected again or after power disruption, main unit settings are initialized, thus resulting in different settings between remote controller and main unit. In such case take the following actions.

Condition	Cause	Action to be taken
The product is not in automatic seat cover operation mode, but it operates as if it is in automatic mode.	<ul style="list-style-type: none"> Check if power plug was disconnected and connected again or there has been power disruption. 	<ul style="list-style-type: none"> On the remote controller, set the automatic seat cover operation and cancel it.(Refer to page 17.)
Toilet seat is not warm enough or cold	<ul style="list-style-type: none"> Check if power plug was disconnected and connected again or there has been power disruption. 	<ul style="list-style-type: none"> Press seat temperature control button(high or low) one or two times and then reset the seat temperature(Refer to page 20.)
Deodorization is set to OFF, but main unit deodorization lamp is ON and deodorization operates when the seat is occupied.	<ul style="list-style-type: none"> Check if power plug was disconnected and connected again or there has been power disruption. 	<ul style="list-style-type: none"> On the remote controller, set deodorization and cancel it. (Refer to page 21.)
Power saving(lo or hi econo) has been set, but power saving lamp on the main unit is OFF and power saving is not in operation.	<ul style="list-style-type: none"> Check if power plug was disconnected and connected again or there has been power disruption. 	<ul style="list-style-type: none"> Press power saving button to set it OFF and reset the desired power saving mode(lo or hi econo). (Refer to page 22).

	Model	BH90	BH93	BH80	BH83
Power source	AC120V 60Hz				
Power consumption	Maximum 1,250WATTS				
Requested water pressure range	10.15~108.77 psi (0.07~0.75MPa)				
Requested water temperature range	41°F~95°F(5~35°C)				
Warm water cleansing system	Water consumption for cleansing (gal/min.)	0.10~0.14gal/min(0.41~0.53 liter/min).			
	Water consumption for bidet cleansing (gal/min.)	0.10~0.14gal/min(0.41~0.53 liter/min).			
	Water pressure level	4 levels for each of cleansing or bidet cleansing (Low, Med,Low, Med, High)			
	Temperature control	4 levels (about 86°F~104°F(30~40°C)) and heater OFF			
	Nozzle position control	6 positions			
	Water heater	1,200W			
	Heat exchange system	Instant heating type			
	Safety devices	Thermo s/w(prevention of overheating), Temperature fuse, Warm water sensor			
Heated seat system	Temperature control	4 levels (about 86°F~104°F(30~40°C)) and heater OFF			
	Seat heater	50W	47W	50W	47W
	Safety device	Temperature fuse			
Drying system	Temperature control	4 levels (about 104°F~131°F(40~55°C)) and heater OFF			
	Dryer heater	290W			
	Dryer air velocity	0.008mi/s(13m/s)			
	Safety device	Temperature fuse, Thermo switch			
Comfort function	Deodorization	Catalytic deodorization			
	Water filter	Ionic water filter			
	Automatic seat cover/seat operation	○		×	
Batteries	AA 1.5V×3				
Power saving mode	Lo econo and Hi econo				
Other safety devices	Electric circuit breaker				
Dimensions(W×D×H)	19.9in×21.4in/19.8in×6.1in 405mm×545mm/505mm×155mm				
Net weight	about 9.7lb (4.4 Kg(including remote controller))				
Length of power cord	about 59.0inch(1.5 meters)				