

Uspa
**Operating
Instruction Manual**

UB-6035R



- *Thank you for purchasing this USPA product.*
- *You are kindly requested to read carefully this operation manual for proper use of this appliance with due attention.*
- *Please save this manual and place in an easily accessible location.*
- *Please register Warranty for proper service.*

**THIS UNIT WAS MANUFACTURED FOR HOUSEHOLD USE ONLY.
READ ALL OPERATING INSTRUCTIONS BEFORE INSTALLATION.**

Notes

- 1. This product should be installed according to this manual.*
- 2. Please read this manual carefully and install properly.*
- 3. Please save this manual and place in an easily accesible location.*
- 4. Do not attempt to service this appliance yourself. Doing so could void the warranty.*

Table of Contents

PREPARATION

| | |
|----------------------------------------|----------|
| 1. IMPORTANT SAFEGUARDS | 1 |
| 2. CAUTIONS BEFORE INSTALLATION | 1 |
| 3. IDENTIFICATION | 3 |
| 4. SAFETY INFORMATION (DANGER) | 4 |
| 5. SAGETY INFORMATION (WARNING) | 6 |

HOW TO USE

| | |
|------------------------|-----------|
| 6. HOW TO USE | 8 |
| 7. HOW TO CLEAN | 14 |
| 8. MAINTENANCE | 15 |

INSTALLATION

| | |
|-------------------------|-----------|
| 9.HOW TO INSTALL | 16 |
|-------------------------|-----------|

ETC

| | |
|---------------------------------------|-----------|
| 10. BEFORE CALLING FOR SERVICE | 19 |
| 11. SPECIFICATIONS | 19 |
| 12. WARRANTY | 20 |

1 Important Safeguards

1. READ ALL INSTRUCTIONS BEFORE USING

DANGER - To reduce the risk of electric shock:

1. Do not place or store this appliance where it can fall or be pulled into a tub or sink.
2. Do not place in, or drop into water or other liquid.
3. Do not reach for a product that has fallen into water. Unplug immediately.

WARNING - To reduce the risk of burns, electric shock, fire or injury to persons.

1. Close supervision is necessary when this appliance is used by or near the very young, the elderly or in invalid. Children should not be permitted to use or touch this appliance without the supervision of an adult.
Be sure to adjust the temperature of the toilet seat for the elderly, those who are incapacitated, or people with sensitive skins.
2. Use this appliance only for its intended purpose as described in this manual. Do not use attachments not recommended by the manufacturer.
3. Never operate this appliance if it has a damaged cord or plug, if it is not working properly, if it has been dropped, damaged or dropped into water.
4. Install the unit properly by following the installation procedure.
5. Only authorized persons can install or repair the unit. Do not attempt to service this appliance yourself. Doing so could void the warranty.
6. Keep the cord away from heated surfaces.
7. Never drop or insert any objects into any opening or hose.
8. Do not use outdoors. Do not use aerosol or oxygen spray products on the unit.
9. Always follow the grounding instruction in this manual before plugging in the unit.

SAVE THESE INSTRUCTIONS

2 Cautions before installation

1. NOTE THE FOLLOWING IMPORTANT POINTS

1. Do not install in a location where water might be splashed on this appliance or in a location exposed to such excessive moisture that condensation forms on the products surface.
2. To avoid damage to electronic components due to high levels of humidity, provide adequate ventilation by opening a window and/or door when bathing. You may find operating an exhaust ventilating fan during these times of high humidity beneficial.
3. Use a water supply having a water pressure of 0.8kgf/cm² to 7.5kgf/cm²
4. Connect the product to a pipe carrying potable water. Do not connect to an industrial water line or other water supply that does not carry water of drinking quality.
5. In areas where water freezes in pipes in winter make arrangements to keep the pipes warm.
The water remaining in the unit may sometimes freeze during storage in winter. In that case, warm the unit in the room before installation.
6. The thermal protector in the water tank may sometimes trip during storage or transportation in warm weather causing non-operation. In that case, cool the unit in the room before installation.
7. The rated power voltage is 120V AC, 60Hz.
8. Do not supply electrical power to the unit until the plumbing installation work has been completed; it could cause malfunction.

2 Cautions before installation

2. WIRING REQUIREMENTS

1. Any other servicing should be performed by an authorized service representative.

2. GROUNDING INSTRUCTIONS

This product should be grounded. In the event of an electrical short circuit, grounding reduces the risk of electric shock by providing an escape wire for the electric current. This product is equipped with a cord having a grounding wire with a grounding plug. The plug must be plugged into an outlet that is properly installed and grounded.

DANGER-Improper use of the grounding plug can result in a risk of electric shock.

If repair or replacement of the cord or plug is necessary, do not connect the grounding wire to either flat blade terminal. The wire with insulating having an outer surface that is green with or without yellow stripes is the grounding wire.

Check with a qualified electrician or serviceperson if the grounding instructions are not completely understood, or if in doubt as to whether the product is properly grounded.

3. This product is for use on a nominal 120V circuit, and has a grounding plug that looks like the plug illustrated in sketch A. A temporary adapter, which looks like the adapter illustrated in sketches B and C, may be used to connect this plug to a 2-pole receptacle as shown in sketch B if a properly grounded outlet is not available. The temporary adapter should be used only until a properly grounded outlet (sketch A) can be installed by a qualified electrician. The green colored rigid ear, lug and the like extending from the adapter must be connected to a permanent ground such as a properly grounded outlet box cover. Whenever the adapter is used, it must be held in place by the screw.

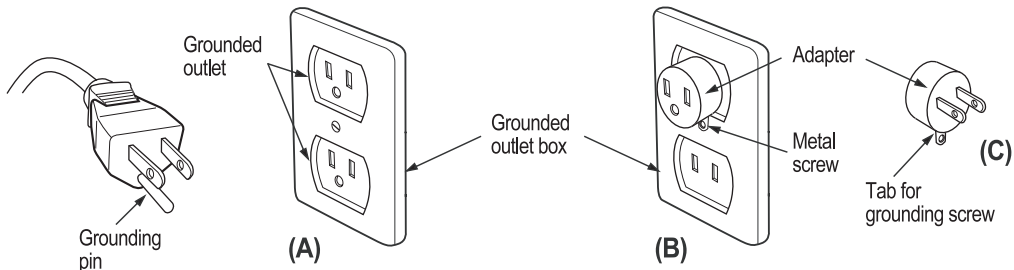

4. If it is necessary to use an extension cord, use only a three wire extension cord that has a three-blade grounding plug, and a three-slot receptacle that will accept the plug on the product. Replace or repair a damaged cord.

5. Remote control power : AAA(1.5V) , 3EA

CAUTION

**RISK OF EXPLOSION TO BATTERY IF REPLACED BY AN INCORRECT TYPE.
DISPOSE OF USED BATTERIES ACCORDING TO THE INSTRUCTIONS**

3 Identification

1. Main unit

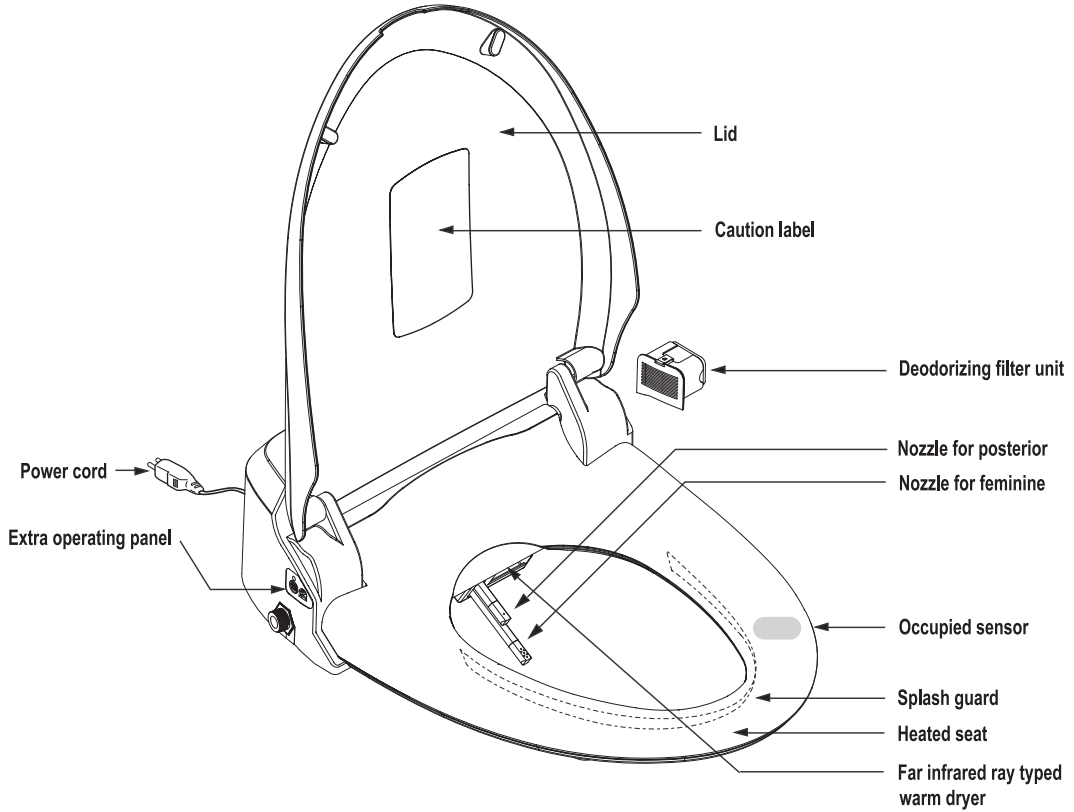

2. Accessories

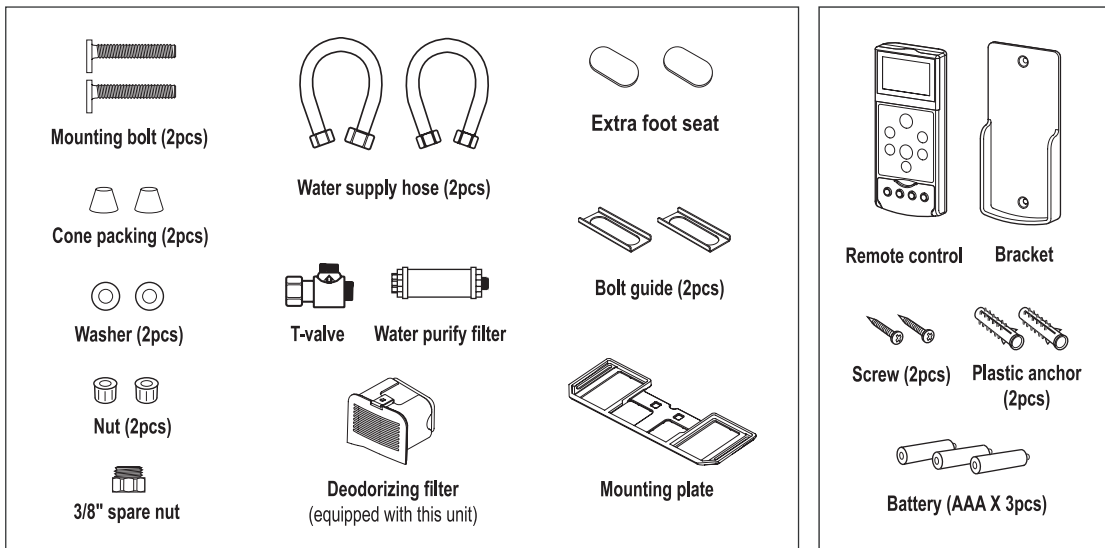



DANGER

Please follow basic instructions to ensure the safe use of your appliance



indicates a prohibited use of the appliance.



indicates a required step in use of this appliance.



Prohibited



Do not handle with wet hands



Do not throw any firearms



Do not disassemble



Do not wash



Ground connection



Required step



Meanings of symbols



PROHIBITED

Do not use a faulty or loose electric outlet or cord.

Doing so may result in a short circuit, electric shock or fire.

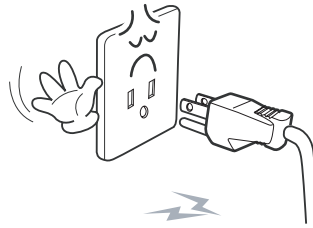

REQUIRED

Do not obstruct the warm air dryer outlet.

- If the outlet is obstructed with any objects, it may result in fire.
- If the outlet is obstructed with hands, it may result in injury.



NO FIREARMS

Do not throw anything flammable into the toilet.

Doing so may result in fire.



DO NOT WASH

Do not wash this appliance with water.

Doing so may result in fire or electric shock.



GROUND CONNECTION

Grounded wire or outlet must be installed

- If avoided, it may result in short shock or malfunction.
- If no grounded plug is used, make sure to install grounded wire





DANGER

Please follow basic instructions to ensure the safe use of your appliance



PROHIBITED

Do not use many appliances in a power strip

- Doing so may result in fire or damage.
- Be sure to use a dry and clean outlet.
- Do not use a faulty or loose outlet.

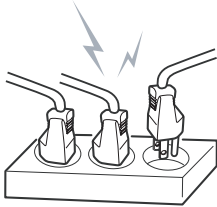

NO WET HANDS

Plug and unplug properly

- Do not plug or unplug with wet hands. It may result in injury or short circuit.
- Do not grab the cord when unplugging. Pull out the plug properly.

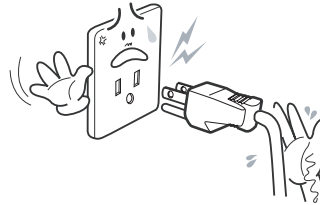

DO NOT DISASSEMBLE

Do not use when the seat and lid are disassembled.

- Doing so may result in electric shock due to high voltage inside.

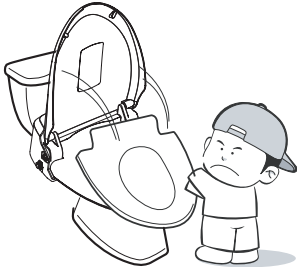

REQUIRED

Unplug when beeping or smelling strangely.

- Unplug right away.
- Contact your dealer where you bought this appliance.

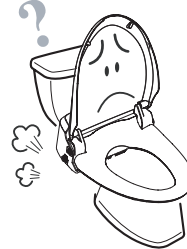

DO NOT DISASSEMBLE

Do not disassemble, repair or modify this appliance.

- Doing so may result in fire or electric shock.



PROHIBITED

Use tap potable water only. (ground water)

- Not doing so may cause irritation or injury to your skin.

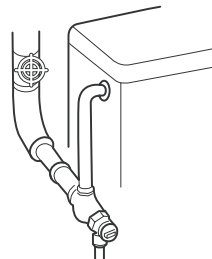

5 Safety Information (Warning)



Warning

Please follow basic instructions to ensure the safe use of your appliance



PROHIBITED

Do not step on or place heavy objects on this appliance.

- Doing so may damage the unit.
- Do not step on a lid, seat or control panel to avoid injury or damage.



REQUIRED

Do not force the lid to close

- Doing so may cause malfunction.



REQUIRED

Be aware of urine splash on a nozzle or warm air dryer outlet.

- Not doing so may result in smelling of products or failure.



PROHIBITED

Do not sit or lean against the lid or control panel.

- Doing so may cause malfunction or breakage.



REQUIRED

Unplug while not using over extended period of time.

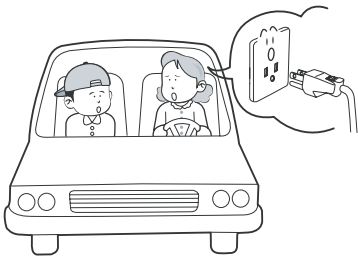

REQUIRED

Unplug while there is thunder or lightning.





Warning

Please follow basic instructions to ensure the safe use of your appliance



PROHIBITED

Do not pull out the waterhose forcefully

- Doing so may cause the water leakage.



REQUIRED

Use this appliance on a toilet only.

- Not doing so may result in fire, injury or electric shock.



~~Improper use~~



PROHIBITED

Do not put a vase, water cup or small materials on this appliance.



PROHIBITED

Be aware of a low-grade burn.

- It may result in a low-grade burn if sitting on the heated seat for a long time.
- Be aware if being used by the following :
 - Children, senior citizens, patients, or who cannot control the grade of temperature.
 - Sleeping pills users, or people who are on medication that causes drowsiness.
 - Who are drunk or very tired and may fall asleep while sitting on the unit.
- If injured in a low-grade burn, see a doctor immediately.



REQUIRED

Unplug when cleaning.

- Not doing so may result in fire or electric shock.

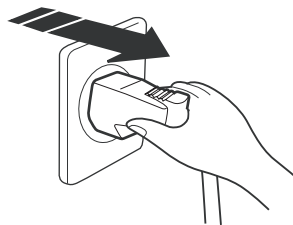

REQUIRED

Use the low temperature for children and disabled.

- If high temperature sets up, it may result in burns due to not recognizing the temperature.

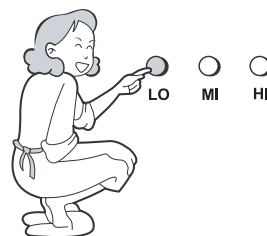

6 How to use

※Caution

- Be aware of not dropping a remote control in water. It may cause out of order or malfunction.
- All functions will be operational when the seat is occupied except Nozzle Cleaning.
- Before operating, ensure that water tank is filled up completely.

Stop

- Press "Stop" to stop current operation.
- When a user stands up, all operations will stop automatically.

Cleansing

- Press "Cleansing" to clean your posterior. The function will stop in 60 seconds automatically.
- Press this button again to activate oscillation. The nozzle moves back and forth automatically to widen cleansing area.
- Oscillation wash stops if this button is pressed again.

Bidet

- Press "Bidet" for feminine wash. The function will stop in 60 seconds automatically.
- Press this button again to activate oscillation. The nozzle moves back and forth automatically to widen cleansing area.
- Oscillation wash stops if this button is pressed again.

Dry (far infrared ray)

- Press "Dry" after "Cleansing" or "Bidet". Far infrared ray typed warm air will come out for 3 minutes.
- To alter the strength of air drying, press this button again.

IIP (intensive impulse pulsation)

- Press "IIP" for easy defecation. Intensive water pulsation may help you to have easy defecation.
- It works for 60 seconds and stops automatically.
- Press "IIP" again for changing the pulsation mode.

Kids

- Press "Kids" to change all functions to be suitable for children.
- 1 minute for oscillation and 3 minutes for dry, level 1 of water pressure and level 5 of nozzle position will be set.
- This unit should be used under the supervision of an adult.

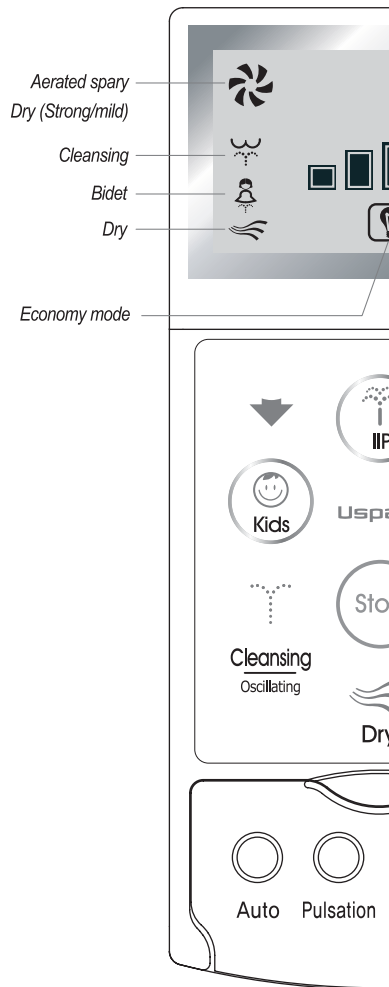

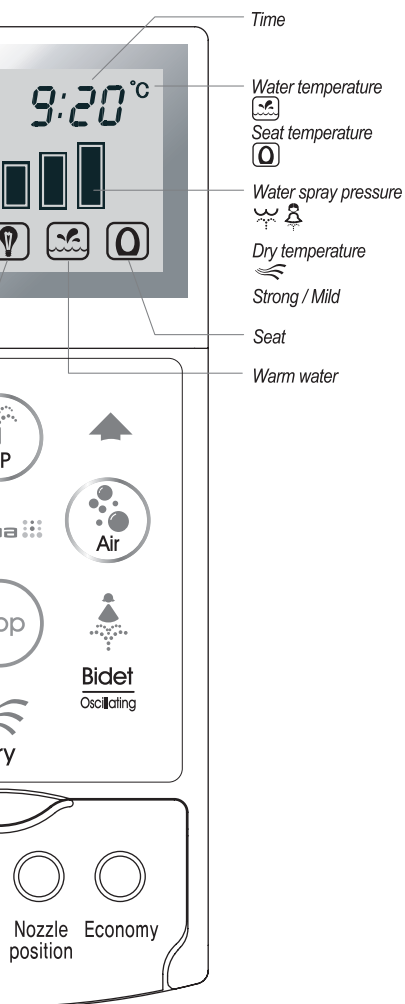

Air (aerated spray)

- Press "Air" to use aerated wash to clean. Gentle, delicate but strong water spray will save water consumption.
- Press this button again to release this function.
- "Cleansing" ; This function is always on.

Water pressure / Dry temperature

- Water spray pressure can be adjustable by pressing or in 5 levels.
- Temperature of dry can be adjustable by pressing or in 5 levels.
- Both levels will be initialized(level 3) after each of use.

Auto

- Press " Auto" during the operation of "Cleansing", cleaning wash, oscillating wash and dry will operate for each 20 seconds consecutively.
- If Bidet Auto wanted, press "Bidet" and "Auto" consecutively.

Pulsation (massage)

- Press "Pulsation" to activate rhythmical wash for massage effect.
- Press "Pulsation" again to release this function.

Nozzle position

- Nozzle position can be adjustable by pressing the nozzle position button.
- Position will be initialized(level 3) after each of use.

Economy

- Press " Economy" to activate the power saving function. The unit will be in economy mode after 1 hours of last use.
- In the economy mode, temperature of water and seat will be kept to 30 degrees celsius. Economy mark(bulb) on the remote control and green light in an extra panel will be shown.
- When the unit is occupied during the economy mode, temperature will be returned to original setting levels and goes back to economy mode after 1 hours of last use.
- Press "Economy" again to release this function. Red light will be turned on in the extra panel.

When the power is plugged in initially, nozzles for feminine wash and posterior wash will come out in turn.

Do not forcefully push or pull the nozzles or bend them. It may result in failure.





Temperature adjustment (water / seat)

- Temperature of seat and water can be adjustable.
- There are four levels, Room temp-Low-Medium-High.

Nozzle cleaning

- Press cleaning button to clean the nozzles manually while not sitting on the seat. Posterior wash nozzle will come out.
- Press cleaning button again. Posterior nozzle will be returned and feminine nozzle will come out.
- Press "Stop" to return nozzle to stand-by mode.

Time setting

- Time on the remote control shows in 24 hours mode.
- To setup the time, press "Time" once and set the time by pressing  .
- Press "time" twice and set the minute by pressing  .
- time will be re-set(00:00) if batteries are changed.

Automatic deodorization

- When the appliance is in use, the deodorizer will work automatically. (max 20 minutes)
- When a user stands up, it stops after 60 seconds.

Self cleaning

- This appliance cleans its nozzles automatically before and after every use by rinsing off.

Self-diagnosis system

- This appliance has a self-diagnostic system, Whenever the appliance has a problem(s), a LED of power on the unit will light on.
- Unplug and contact service center immediately.

Side extra control panels

- Use a side extra control panels when the remote controller is broken or its batteries are dead.
- Do not use sharp edged items to press buttons.
- To turn off the unit, press "Power/Bidet" while not sitting on the seat.

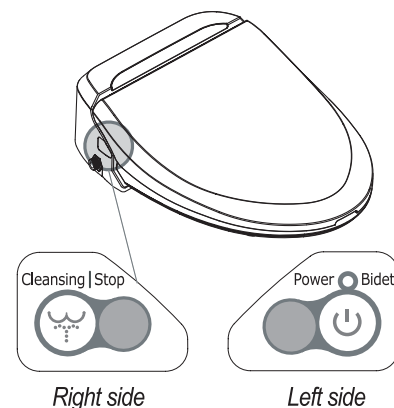
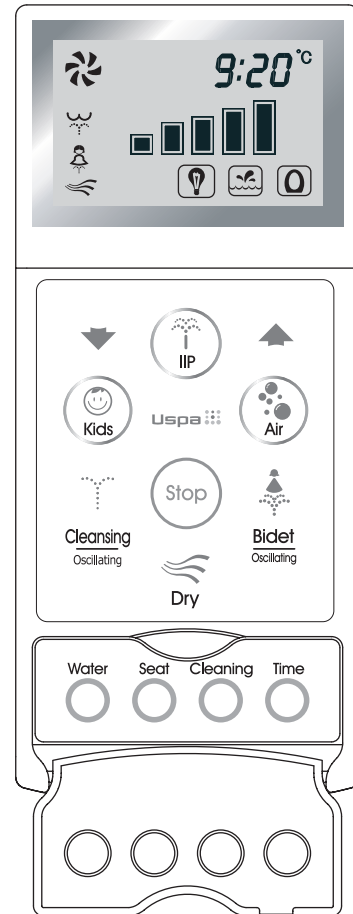

Identification

- This function is useful for public toilets when more than one unit of this product installed.
- To prevent interference among units, main unit and remote control should be set with the same ID.
- If there is only one unit in the bathroom, you do not need to set ID.
- Initial ID of remote control and main unit are "0". (*1d:00*)
There are 16 choices in ID (0 ~ 15)

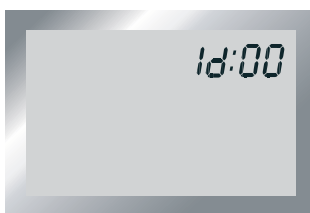

How to set ID

Remote control

- Press "Stop" for 5 seconds and *1d:00* shows up in display.
- Press $\blacktriangleleft \blacktriangleright$ until your ID appears in display. (00 ~ 15)
- Press "Stop" again to set ID, and display will return to stand-by mode.

Main unit

- After setting of remote control, please follow direction of body setting.
- Plug in and turn off the power and then hold power button 2~second and Push the stop button of remote control at the same time.
(You could hear beep sound.)

Note

- If both IDs of remote control and main unit are different, main unit will not work.
- Make sure both sides are set with the same ID.
- ID will be initialized (*1d:00*) if the power is unplugged or batteries of remote control are replaced.

7 How to clean

Nozzle cleaning

Caution Do not forcefully push or pull the nozzles, or bend them. It may result in failure. Make sure to use "Cleaning" button on the remote control.

- 1 Make sure the occupied sensor is not activated. (not sitting on the seat or not place hands on the seat sensor part)
- 2 Press "Cleaning" button, posterior nozzle comes out. Press this button again, feminine nozzle comes out.
- 3 Do not forcefully push or pull the nozzles, or bend them. Use a toothbrush or soft cloth to clean nozzles. Press "Stop", and nozzle will return to stand-by mode. For extended period of time cleaning, unplug for safety.
- 4 Do not retract nozzles without a nozzle tip. It may result in malfunction.
- 5 Beware of lost tips and changes.

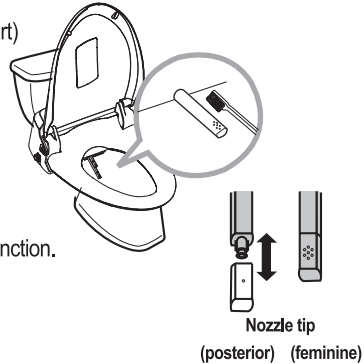

Strainer maintenance

This appliance will not operate properly if the strainer is clogged. Be sure to clean the strainer regularly.

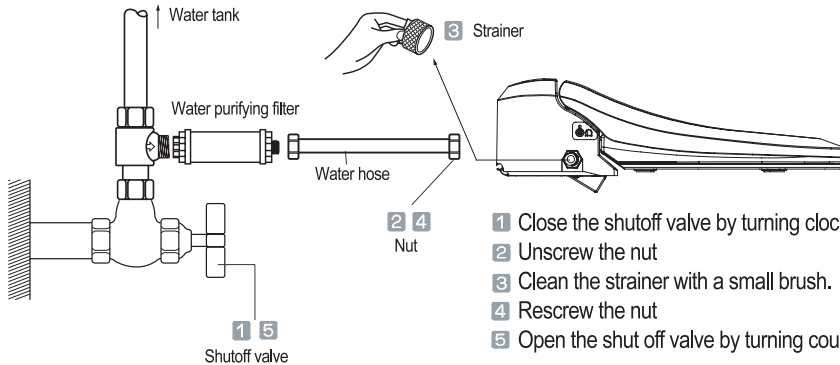

- 1 Close the shutoff valve by turning clockwise.
- 2 Unscrew the nut
- 3 Clean the strainer with a small brush.
- 4 Rescrew the nut
- 5 Open the shut off valve by turning counter clockwise.

Cleaning the body

- 1 Regularly wipe off the body with a dry soft cloth or sponge, or dampen with neutral detergent.
- 2 Release the lid.
 1. Pull left and up the left hinge part .
 2. Release the right hinge part (Be aware your fingers not to be caught)
- 3 For care of plastic body, do not use any cleansers which are not safe to use on toilet seats. (toilet cleanser, home cleanser, bleach, benzene, paint thinner, cresol etc)

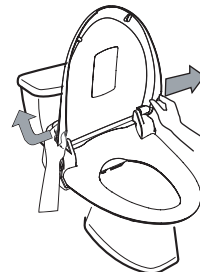

8 Maintenance

Draining water - while not using over extended period of time

- 1 Unplug the power supply cord.**
■ Not doing so may cause fire.

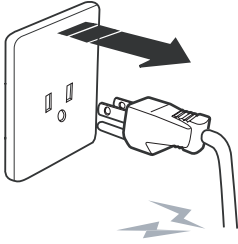

- 2 Close the shutoff valve.**

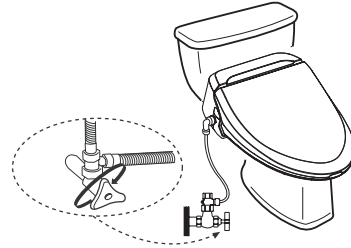

- 3 Unscrew the mounting bolts.**
■ Refer to the installation method.



- 4 Uphold the appliance and thoroughly drain the water by unscrewing the drain bolt.**
(beware of losing the drain bolt)

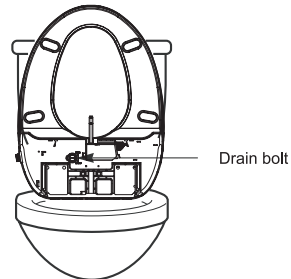

- 5 Screw the drain bolt and install the appliance.**
■ Refer to the trial operation method in order to use this appliance again.

Preventing freezing

- 1 Make sure the power cord is plugged in properly.**

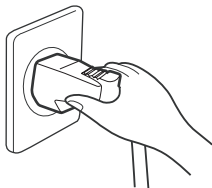

- 2 Set the temperature of water to low or middle.**
(Freezing can be prevented by thermal efficiency of water tank.)

- If there is no heating system in the toilet, wrap pipes with cloth or other materials.

- 3 Not using the unit for a long time in winter, unplug and drain the water from the water tank and pipes thoroughly.**

- Refer to the water drain method.

9 How to install



Do not plug in until installation is finished completely.
Not doing so may damage the appliance.

If electric work is needed, contact to the qualified electrician or serviceman only.

Remove the existing toilet lid and seat

1. Remove the nuts, washers and cone packings from the toilet seat mounting bolts in the back of the toilet.
2. Remove the toilet seat, lid and mounting bolts.
3. Keep them in case of installing again.

Install the appliance

Installation

How to mount the plate

Place the plate and guides over each mounting hole. Insert the mounting bolts through the plate and mounting holes, and slide cone packings and washers onto the bolts.

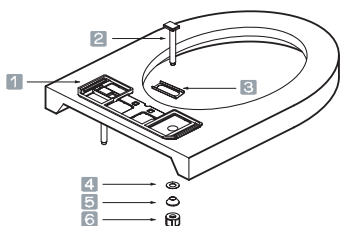

- | | | |
|------------------|-----------------|---------|
| 1 Mounting plate | 2 Mounting bolt | 3 Guide |
| 4 Washer | 5 Cone packing | 6 Nut |

How to attach and detach the unit

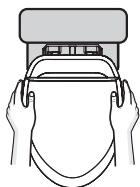

Slide the unit until it clicks into plate.



Lift the unit up and forward.

Toilet size (elongated & round front)

The toilet dimensions must be within those shown below. Do not install this appliance on a toilet that does not meet those dimensional requirements.

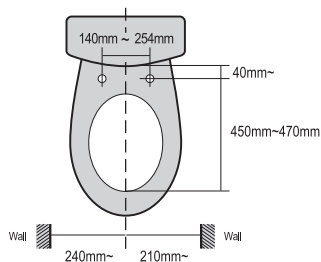

Occupied sensor

- This appliance is equipped with occupied sensor.
- Unit will not work unless seat is occupied.

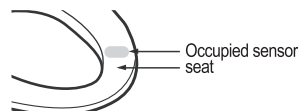

Install the SPACER SEAT

- If the bidet seat does not match toilet bowl properly, Spacer seat helps to be fitted. Attach the spacer seat on foot seats. The position of SPACER SEAT.

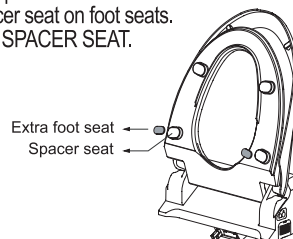

Installation of remote control unit

How to Insert batteries

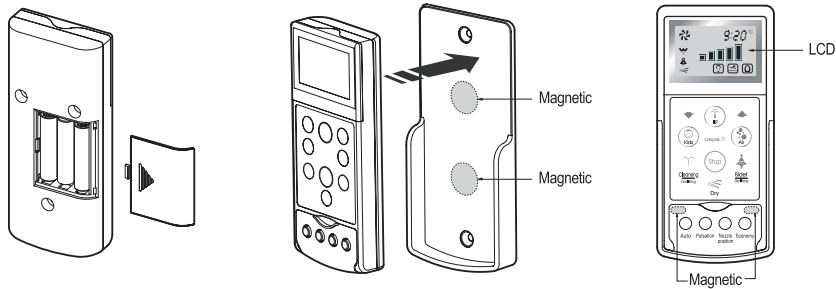

1. Open the battery lid of remote control and insert 3 AAA batteries into battery compartment.
2. Check the display appears properly.
3. Check the remote control works properly while seat is occupied.
4. Install the remote control bracket on the wall as shown below.

Note following precautions to prevent ruptured batteries and battery acid leakage.

- Use 3 AAA batteries only and do not use rechargeable batteries.
- Do not use old and new batteries together and same type of batteries only.
- Make sure that all batteries are inserted into their correct positions.
- Remove the batteries if the remote control is not used for a long time.
- LCD would fades or blinks if the batteries reach the end of their life. Change the batteries immediately.
- Settings (time, power saving mode) will be lost when batteries are replaced.

How to attach remote control unit

Use double sided tape

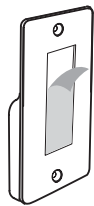

Use screw with plastic anchor

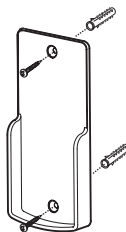

Recommended position of attachment

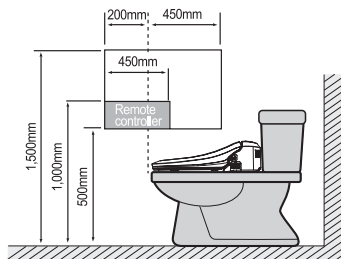

- Keep the remote control unit in the bracket to prevent damage by dropping.

Connecting the water hose and grounding wire

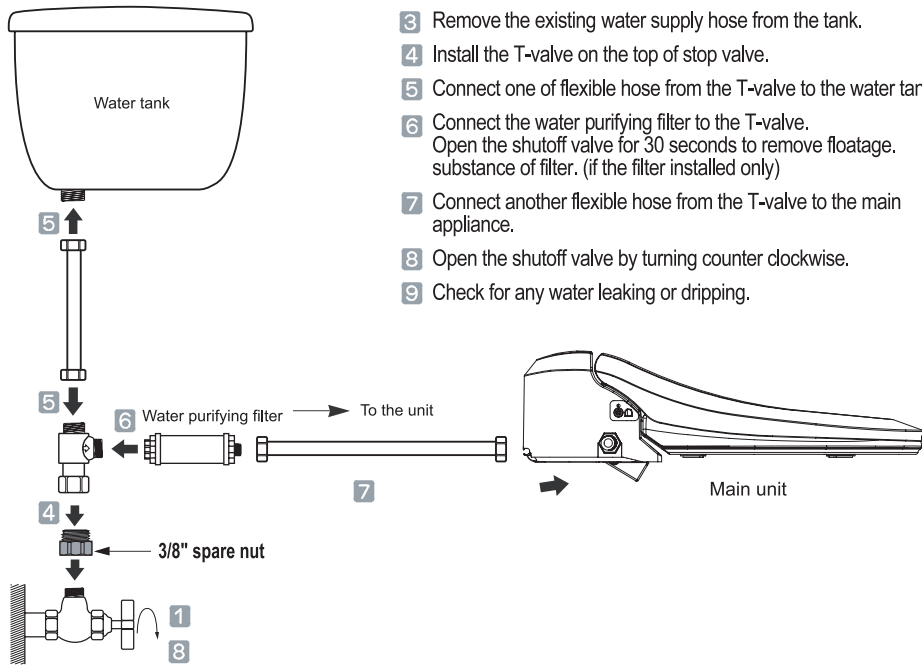

※ Water filter is optional.

Trial operation

1. Preparation

Open the shutoff valve and check for any water leaking or dripping.
 Plug the power cord into the outlet.
 Press the "BIDET" or "CLEANSING", then water tank will be filled with water in 2 minutes.
 After the water tank has filled up, you will hear long buzzer sound.

2. Checking all functions

Cover the toilet bowl using the plastic wrapping sheet of the unit to prevent the washing water from being sprayed out of the toilet.
 Then check for all function described in this manual.

3. There are possibilities of water coming out that remains in the unit while heating.

10 Before calling for service

| Problem | Possible cause | Solution |
|---------------------------------------|--------------------------------------------------------------------------------------------------------------------------------------|-------------------------------------------------------------------------------------------------------------------------|
| Completely fails to work | Is there a power cord outage? Is the powercord unplugged? Are you sitting on the seat correctly? | Check for a power cord failure or a tripped breaker Plug the power cord in properly Sit on the seat completely |
| Water does not spray | Is the water shutoff valve closed? Is the strainer clogged? Are the nozzles clogged? Is the water purifying filter clogged? | Check for any water leaking or dripping Clean the strainer Clean the nozzles Change the water purifying filter |
| Water is leaking or dripping | Check for all hoses are tightened properly | If water is still leaking or dripping, contact to your dealer |
| Seat, water or air is not enough warm | Is the temperature set to OFF? Is appliance used in economy mode such a cold weather? | Reset the temperature Release the economy function |

11 Specifications

| Item | UB-6035R |
|-----------------------|------------------------------------------------------------------------|
| Standard power supply | AC 120V 60Hz 660W |
| Water supply | Way of connection Direct connection to tap water |
| | Water pressure 0.08MPa ~ 0.75MPa |
| Cleaning | Spray for cleansing 900 ± 100ml/min |
| | Spray for bidet 900 ± 100ml/min |
| | Water capacity 800 ml |
| | Spray temperature Room Temp ~ 40°C (104°F) |
| | Heater capacity 600W |
| | Safety feature Thermal switch, Temperature fuse, Floating switch |
| Dry | Air temperature Room temp ~ 60°C (140°F) |
| | Heater capacity 250W |
| | Safety feature Temperature fuse |
| Heated seat | Seat temperature Room temp ~ 40°C (104°F) |
| | Heater capacity 55W |
| | Safety feature Temperature fuse |
| Deodorization method | Catalytic filter |
| Circuit breaker | Within 15mA 0.03 second |
| Length of power cord | 1.2m |
| Dimensions | (W)392mm X (L)520mm X (H)143 (W)15.43inch X (L)20.47inch X (H)5.62inch |
| Weight | 4.4Kg(9.7lbs) |

※ Recommended water supply pressure are 0.1MPa-0.69MPa

※ The minimum available water supply pressure is 0.08MPa-0.1MPa, however under 0.1Mpa pressure, water spray pressure might not be enough strong.

WARRANTY

USPA Personal Hygiene Appliance Limited Warranty

- We warrant our products to be free from manufacturing defects under normal use and service for a period of one (1) year from date of your purchase. Only the ORIGINAL PURCHASER you may make a claim under this limited warranty.
 - Our obligation to you under this warranty is limited to repair or replacement, at our option, of defective products or parts, provided that the products were properly installed and used in accordance with instructions. We reserve the right to make inspections in order to determine the cause of the defect. We will not charge for labor or parts in connection with warranty repairs or replacement. We are not responsible for the cost of removal, return and/or reinstallation of products.
 - This limited warranty does not apply to:
 - a) Damage or loss from a fire, earthquake, flood, storm, etc
 - b) Damage or loss resulting from any unreasonable use, abuse, negligence, or improper maintenance.
 - c) Damage or loss from improper installation, removal, repair, or modification.
 - d) Damage or loss resulting from sediment or other matters contained in your water system.
 - This warranty gives you specific legal rights.
 - For warranty or service information, please contact your dealer where you bought this appliance or us.
 - Only the original purchaser may submit a claim under this limited warranty. To activate your warranty, complete this form.
 - This limited warranty is our only warranty covering your product. Repair or replacement as provided under this warranty shall be the exclusive remedy available to you. We shall not be responsible for loss of the product or for other incidental, or consequential damage or expenses you may incur or for labor or other costs due to installation or removal, or cost or repairs by others, or for any other expense not specifically stated above. Except to the extent prohibited by applicable law, any implied warranties, including that of merchantability or fitness for use, are expressly limited to the duration of this warranty.
- ※ Warning! We are not responsible or liable for any failure of, or damage to, this plumbing product or product component caused by in-tank bowl cleaners containing chlorine(calcium hypochlorite).
- ※ Note : The use of high concentration of chlorine related products can seriously damage the fittings. This damage can cause leakage and serious property damage.

For more information, please contact your dealer or us.

Purchase Date _____ Purchased From _____
Invoice # _____ Amount Paid _____ Serial # _____
Address _____ City _____ State _____ Country _____ Zip _____
Phone _____ Fax _____ E-mail _____

Mail, email or fax the warranty form to :

BBC INNOVATION

205 Berg St., Algonquin, IL 60102

Phone: 847_854_7292 Fax: 847_854_1296

E-mail: support@biobidet.com <http://www.biobidet.com>

if your dealer is unable to assist you,

SAMHONGTECH CO., LTD

WOOJUNG TOWN 9F, 1488-7, KWANYANG-DONG, DONGAN-KU, ANYANG-CITY, KOREA 431-060

Phone: +82_31_420_2341~5 FAX: +82_31_426_8666

E-mail: webbidet@samhongtech.co.kr <http://www.samhongtech.co.kr>

Great products for your healthy living !



BBC INNOVATION

205 Berg St., Algonquin, IL 60102

Phone: 847_854_7292

Fax: 847_854_1296

E-mail: support@biobidet.com

www.biobidet.com