

ALPHA

— B I D E T —

UX Pearl

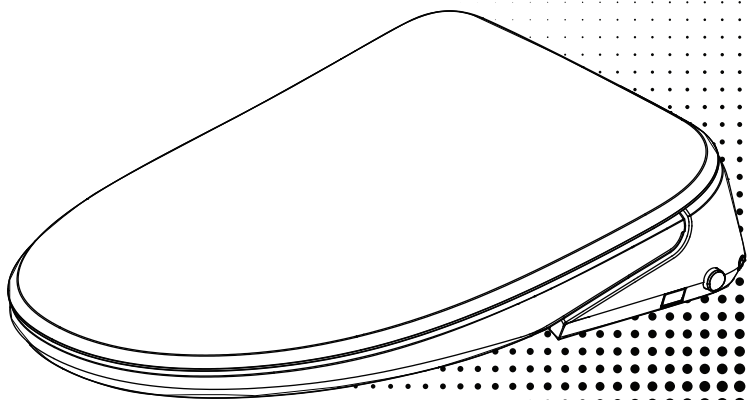

# Content

1. Important Safeguards and Instructions.....	01-02
2. Parts Identification .....	03
3. Main Unit Knob Instructions.....	04
4. Technical Specification.....	05
5. Packing List .....	06
6. Product Dimension and Installation Tool.....	07
7. Installation of Main Unit.....	07
Installation of Base Plate.....	07
Installation and Disassembly of Main Unit.....	07
Installation of Water Inlet Pipe and T Valve.....	08
8. Preparation .....	09
9. Maintenance .....	10
Maintenance of Bidet Seat .....	10
Nozzle .....	10
Filter Maintenance .....	10
Filter Cleaning for Pressure-maintaining Valve.....	11
Self-cleaning Waterway Maintenance.....	11
Disassembly and Installation of supply hose.....	12
10. Troubleshooting Guide .....	13

## Let's Get Started

Scan the QR code with your smartphone's camera for help with installation.

Or visit:

<https://alphabidet.com/pages/getstarted>



# IMPORTANT SAFEGUARDS

When using electrical products, especially when children are present, basic safety precautions should always be followed, including the following:

1. The appliance is not to be used by persons (including children) with reduced physical, sensory or mental capabilities, or lack of experience and knowledge, unless they have been given supervision or instruction.
2. This appliance can be used by children aged from 8 years and above and persons with reduced physical, sensory or mental capabilities or lack of experience and knowledge if they have been given supervision or instruction concerning use of the appliance in a safe way and understand the hazards involved.
3. Children shall not play with the appliance.
4. Cleaning and user maintenance shall not be made by children without supervision.

## READ ALL INSTRUCTIONS BEFORE USING



### **DANGER -To reduce the risk of electrocution:**

1. Do not use while bathing.
2. Do not place or store product where it can fall or be pulled into a tub or sink.
3. Do not place in or drop into water or other liquid.
4. Do not reach for a product that has fallen into water. Unplug immediately.
5. Do not wash the main unit or electrical plug with water or detergent.
6. Do not handle the electrical plug with wet hands.
7. Do not put a hand or other materials over the outlet of air dryer or block the outlet of air dryer.
8. Never disassemble, repair or modify this product.
9. During installation, disassembly, repair and maintenance of the product, the power plug must be switched off and water supply be shut off.



### **WARNING -To reduce the risk of burns, electrocution, fire, or injury to persons.**

1. Close supervision is necessary when this product is used by, on, or near children or individuals with disabilities.
2. Use this product only for its intended use as described in this manual. Do not use attachments not recommended by the manufacturer.
3. Never operate this product if it has a damaged cord or plug, if it is not working properly, if it has been dropped or damaged, or dropped into water. Return the product to a service center for examination and repair.
4. Keep the cord away from heated surfaces.
5. Never use while sleeping or drowsy.
6. Never drop or insert any object into any opening or hose.
7. Do not use outdoors or operate where aerosol (spray) products are being used or where oxygen is being administered.
8. Connect this product to a properly grounded outlet only. See Grounding Instructions.
9. Do not throw cigarettes and other burning materials into toilet, otherwise it might cause fire.
10. This product is an electric appliance, so it must be placed far away from water and other liquid.
11. Do not lay the product on its side or upside during the electrical circuit.
12. It is prohibited to use other electric appliances in the same socket.
13. It is forbidden to use the power extension or unstable loose outlet.
14. Do not reuse any existing water supply hoses, otherwise it might cause leakage, fire or electrical shock. Installation of the bidet seat should include specified components and a new water supply hose.

# IMPORTANT SAFETY INSTRUCTIONS



**CAUTION** – Indicates that failure to follow the instruction may cause body injury or property damage.

1. Do not install or use the product in wet places like showers or steam rooms
2. It is recommended to use water-proof electrical outlet which should be installed in a place where is not easily to get wet.
3. This product should be used with 110V-120V, 50/60Hz electrical current only, load current is at least 15A. Power plug must be equipped with ground fault circuit interrupter or ground fault electrical leakage protector or similar high sensitive, rapid type leakage switch (Rated sensitive current under 6mA).
4. During thunderstorms, it is strongly recommended to unplug the seat to avoid power surges
5. Take care when cleaning. Only use warm water and mild soap or a natural disinfectant like vinegar.
6. Do not use bleach, ammonia, or alcohol based chemical cleaners (most bathroom cleaners) on the bidet seat. This will result in discoloration and cracks over time.
7. Do not stand on product unit, seat and cover.
8. Do not lean your weight back against the lid while seated
9. This product is equipped with a soft-closing seat cover. Do not push the toilet seat closed, or damage may occur.
10. Do not use lacquer thinner, petrol, liquid medicine, detergent, insecticide, toilet cleanser and scrubbing brush to clean the product.
11. Avoid exposure to direct sunlight as the plastic may discolor or crack over time
12. Only use tap water or potable water, otherwise it may cause skin irritation
13. Do not connect the seat to a hot water supply (cold water only). Make sure incoming water temperature is between 35-95 F
14. Raise rest room temperature to prevent the toilet from damage due to freezing.
15. When moving the product from cold or wet environment into normal room temperature, wait for 2 hours until the condensation water is fully volatilized. Doing so can prevent the product from electrical short-circuit.
16. Stop using the product and shut off the power when product malfunctions.  
Call for professional service.

## GROUNDING INSTRUCTIONS

This product should be grounded. In the event of an electrical short circuit, grounding reduces the risk of electric shock by providing an escape wire for the electric current. This product is equipped with a cord having a grounding wire with a grounding plug. The plug must be plugged into an outlet that is properly installed and grounded.



**DANGER** – Improper use of the grounding plug can result in a risk of electric shock.

If repair or replacement of the cord or plug is necessary, do not connect the grounding wire to either flat blade terminal. The wire with insulation having an outer surface that is green with or without yellow stripes is the grounding wire.

This product is factory equipped with a specific electric cord and plug to permit connection to a proper electric circuit. Make sure that the product is connected to an outlet having the same configuration as the plug. No adapter should be used with this product. Do not modify the plug provided – if it will not fit the outlet, have the proper outlet installed by a qualified electrician. If the product must be reconnected for use on a different type of electric circuit, the reconnection should be made by qualified service personnel.

## SAVE THESE INSTRUCTIONS



# Parts Identification

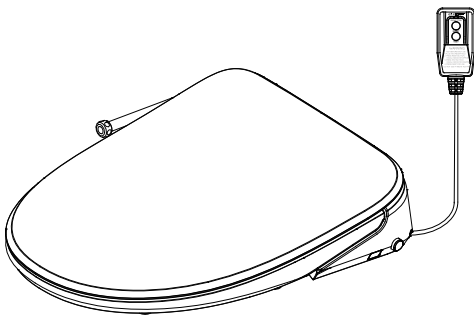
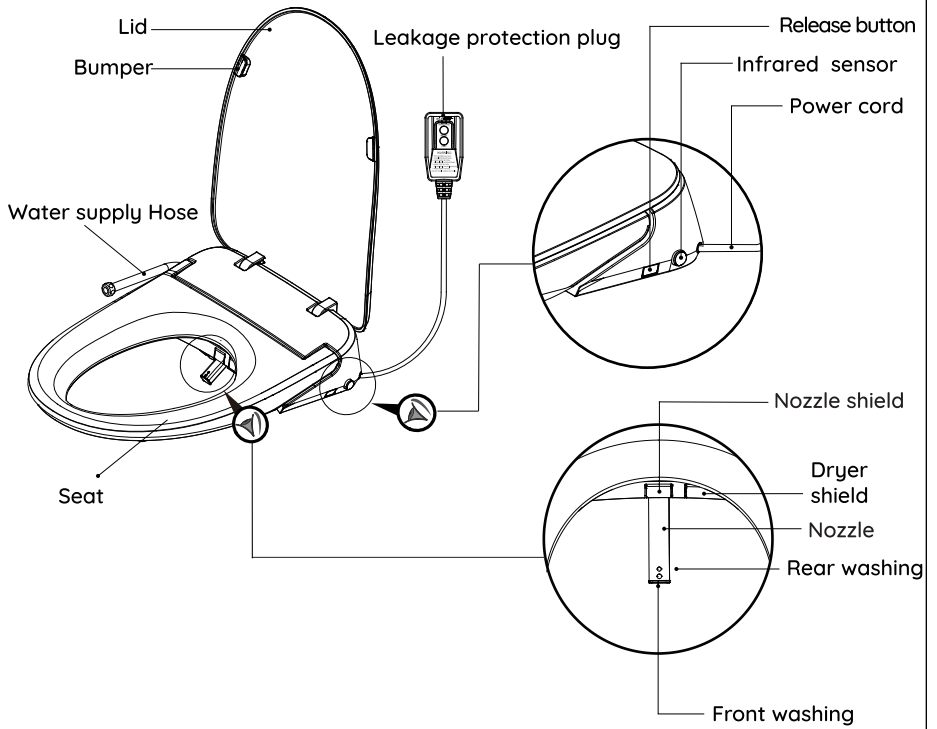

Full bidet seat unit



Remote control

# Side Control Knob Instructions

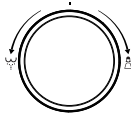

<p><b>Rear Wash</b></p>	<p>1. While seated, turn the Side Control Knob counterclockwise to start a Rear Wash. The seat will complete a full rear wash cycle, then stop.                  2. During the wash, turning the knob clockwise will move the nozzle forward. Turning the knob counterclockwise will move the nozzle backward</p>	A circular diagram of the Side Control Knob with a clockwise rotation arrow and the number '2' at the top.
<p><b>Front Wash</b></p>	<p>1. While seated, turn the Side Control Knob clockwise to start a Front Wash. The seat will complete a full front wash cycle, then stop.                  2. During the wash, turning the knob clockwise will move the nozzle forward. Turning the knob counterclockwise will move the nozzle backward</p>	A circular diagram of the Side Control Knob with a clockwise rotation arrow and the number '2' at the top.
<p><b>Stop</b></p>	<p>Press the Side Control Knob inwards to stop any in-progress washing, drying, or nozzle cleaning functions.</p>	A circular diagram of the Side Control Knob with an arrow pointing inward towards the center and the number '3' at the bottom.
<p><b>Halo LED Light</b></p>	<p>Press the knob in and hold for 3 seconds to toggle the control knob's halo LED light on or off.</p>	

# Technical Specification

<b>Main Unit</b>	Rated voltage	110V-120V, 50/60Hz
	Rated power	870W
	Inlet water pressure	0.08MPa - 0.8MPa (Static pressure)
	Power cord length	About 1.2m
<b>Cleaning device</b>	Heating power	1400W (120V)
	Water temperature	6-level adjustment
	Spray pressure	5-level adjustment
	Cleaning modes	Rear wash / oscillation, Front wash / oscillation, Easy wash, Auto wash/dry
	Nozzle position	5-level adjustment
	Water pressure protector	Pressure maintaining device, Automatic pressure relief device
	Backflow prevention	Anti-syphon device, Anti-backflow device, Filter device
<b>Drying device</b>	Safety device	Water temperature sensor, Dry heating protection, Thermostat, Thermal fuse, Ground protection, Leakage protection, Anti-freezing and anti-cracking device
	Warm air volume	Over 0.2m <sup>3</sup> /min
	Warm air temperature	6-level adjustment
	Heating power	200W
<b>Deodorization</b>	Safety device	Over-heating protection, Thermal fuse
<b>Heated seat</b>	Deodorization method	Photocatalyst-free
	Surface temperature	6-level adjustment
	Heating power	50W
	Open and close device	Soft close
	Burn protection	After 10 minutes of use, the seat temperature will automatically drop slowly to a low level
<b>Safety device</b>	Safety device	Seat sensor, Temperature sensor, Bimetallic thermostat, Thermal fuse

# Packing List

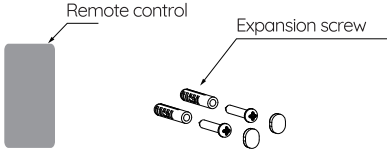
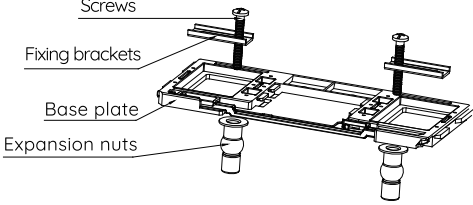
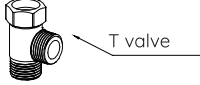
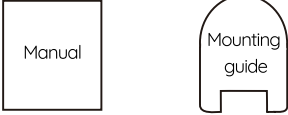
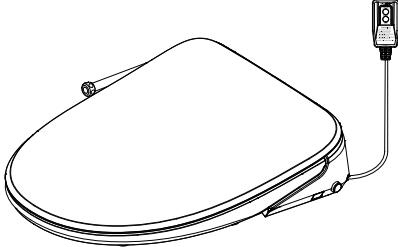
<p><b>The remote control assembly</b></p>	<p>1. Remote control</p>	 <p>Remote control</p> <p>Expansion screw</p>
<p><b>Base plate assembly</b></p>	<p>1. Base plate</p>	 <p>Screws</p> <p>Fixing brackets</p> <p>Base plate</p> <p>Expansion nuts</p>
<p><b>The filter assembly</b></p>	<p>T valve (1)</p>	 <p>T valve</p>
<p><b>Manual, Mounting guide</b></p>	<p>1. Manual</p>	 <p>Manual</p> <p>Mounting guide</p>
<p><b>Main unit</b></p>		



## Toilet Requirements

## Product Dimensions

## Recommended Tools

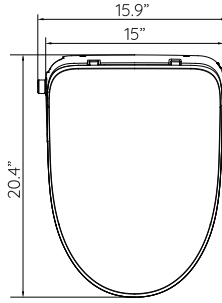
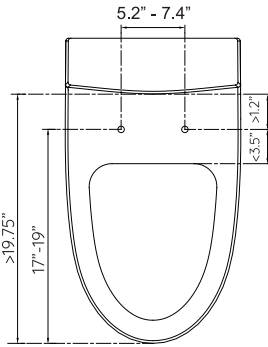

\* Note: Please make sure your toilet is compatible before connecting water or electricity.



Phillips screwdriver



Wrench

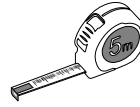

Tape measure



Cup

## Installation of Main Unit

\* This product has been pressure tested at the factory with distilled water before shipping. Please note that there may be residual water present. This is normal.

\* Do not install this product in wet rooms like showers or saunas.

### 1 Installation of base plate

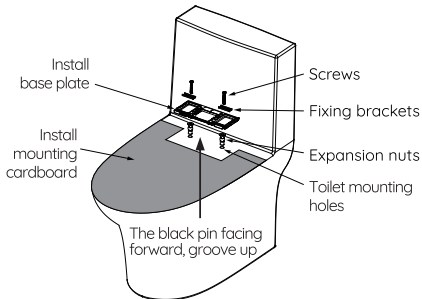

After removing your toilet seat completely, insert the expansion nuts into the mounting holes. Press them in until the collar is flush with the surface of your toilet bowl. Then, secure the base plate using the screws and fixing brackets as shown in the image. Tighten the screws so that the base plate is secured and does not wiggle.

### 2 Installation and disassembly of main unit

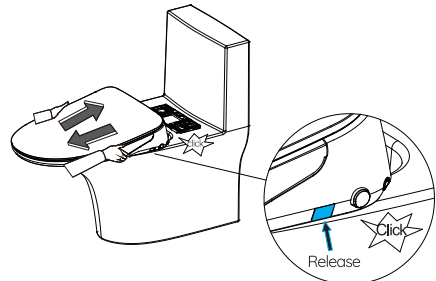

Installation: slide the bidet seat into the base plate and push back until it locks in place with a click. If you pull forward, it should not slide forward.

Disassembly: Locate and press the release button near the electrical cord. This will release the seat from the base plate and allow you to slide it forward.

## Installation of water inlet hose and T valve

Please select the appropriate installation method according to your actual situation

3

Method 1 - standard installation with accessible toilet fill valve.

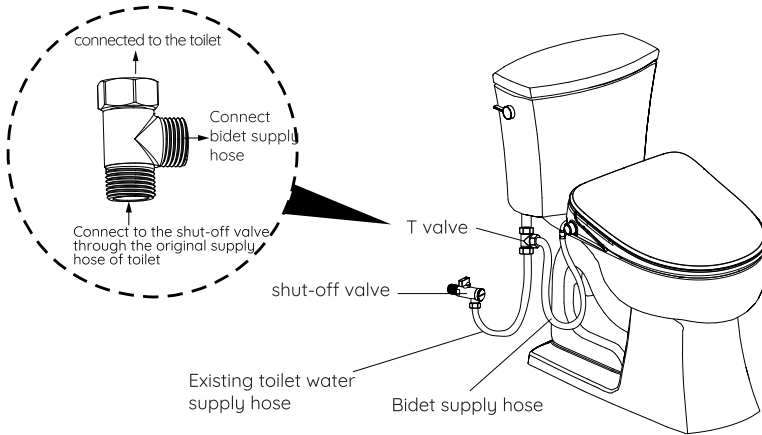

- ① Connect the T valve to the toilet fill valve as shown. Ensure the rubber washer is present at the T valve to toilet connection.
- ② Connect your existing toilet water supply hose as shown above.
- ③ Connect bidet water supply hose to T valve as shown above.

Method 2 - installation on skirted toilet. If your toilet fill valve is inaccessible (skirted toilet), contact us for an alternative t-valve that is installed on the shut-off valve.

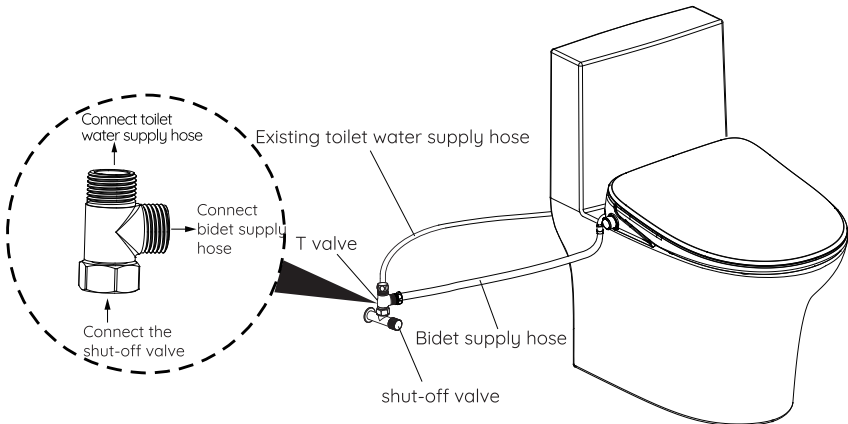

- ① Connect the alternative t-valve to the shut-off valve.
- ② Connect your existing toilet water supply hose as shown above.
- ③ Connect bidet water supply hose to T valve as shown above.

# Preparation

## 1. Turn on the water supply

- Slowly open the shut-off valve. Check for leaks at each threaded connection. If no leaks are present, open the shut-off valve completely and continue monitoring until sure.
- If the T valve to toilet connection is leaking, it's generally because the washer is not present or seated properly. Please double check and also check to see that the T valve is threaded on straight.
- If the bidet supply hose to T valve connection is leaking, double check that the hose's rubber washer is present and seated properly.

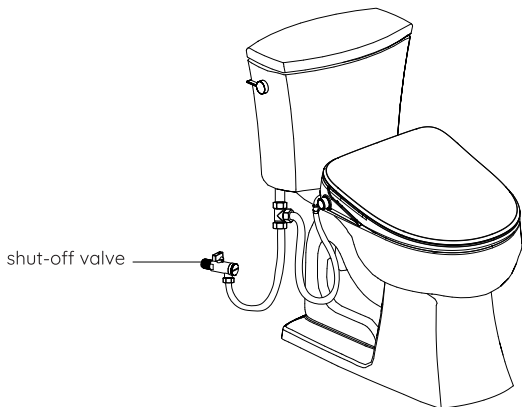

## 2. Power Connection

- Plug the power cord into a GFCI electrical outlet. Press the reset switch and the plug's indicator light should appear, indicating that the power is on.

Note:

Press the test button prior to usage, the reset switch pops up and the indicator light goes off, indicating that the leakage protection function is normal.

Press the TEST button (then RESET button) every month to assure proper operation.

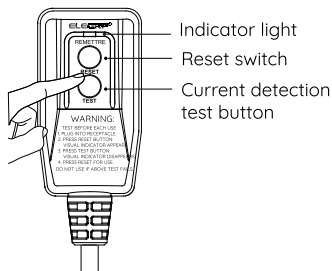

- \* Only for models with leakage protection plug.
- \* Please refer to the actual product.

## 3. Start up and self inspection

1. Once the water is turned on and the power is connected, the seat will beep once. The white light around the knob will flash as the seat begins its start up and self inspection sequence.
2. The seat will beep again when the startup sequence is complete and the knob light should be a steady white.
3. Your Alpha UX Pearl is ready to use.

# Maintenance

## Maintenance of Bidet Seat

1. Unplug the power cord before doing maintenance.
2. Use only a soft, damp cloth with mild soap to clean. Avoid using harsh chemical cleaners like bleach, ammonia, and alcohol or the seat will discolor and crack over time. These chemicals degrade plastic.

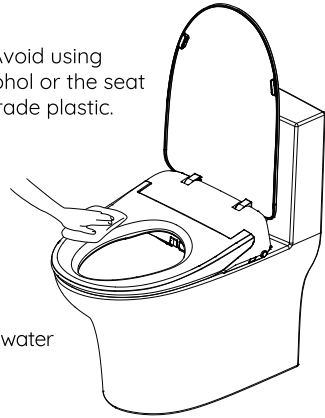
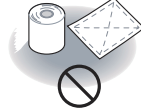

Note: Do not rinse the surface of the product directly with water during maintenance.

## Nozzle

The stainless steel nozzle cleans itself before and after each wash cycle. You can also manually clean it every once in a while.

1. When nobody is seated, turn the Side Control Knob clockwise. The nozzle will extend and stay out for manual cleaning with a cloth or soft brush.
2. The nozzle tip can be removed and cleaned separately. Grip the base of the nozzle with one hand and pull the nozzle tip out with the other. Use a soft brush to clean the tip.
3. Put the nozzle tip back in place but do not force the whole nozzle assembly back in. Press the Side Control Knob in or the STOP button on the remote to have the nozzle retract.

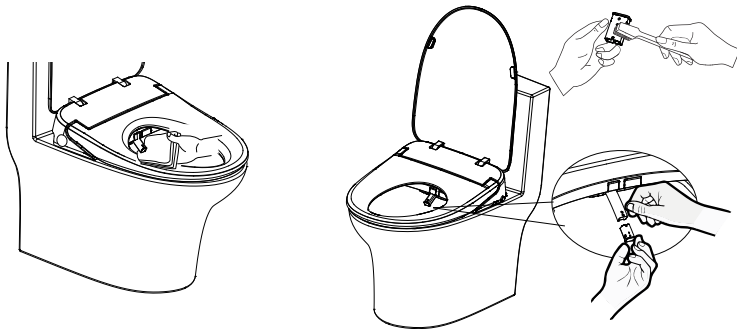

Note: Avoid pulling or pushing the nozzle to avoid damage

## Filter Maintenance

If poor spray performance occurs under normal conditions:

1. Turn off the shut-off valve.
2. Disconnect the water supply hoses from T valve.
3. Take out filter and filter washer.
4. Clean out the filter under running water using a toothbrush.
5. Reinstall filter and filter washer, then re-connect water supply pipes.

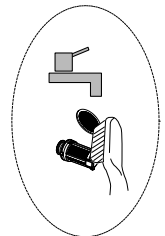
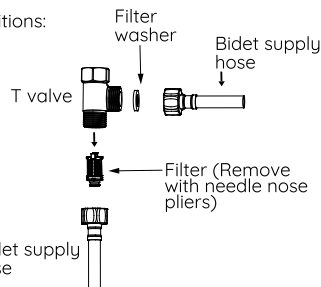

## Filter Cleaning for Pressure-maintaining Valve

1. Turn off the shut-off valve.
2. Unplug from electrical outlet
3. Disassemble the cover and unscrew the filter connector cover with a screwdriver.
4. Take out the filter assembly with needle nose pliers.
5. Clean out the filter under running water using a toothbrush.
6. Reinstall the filter and tighten the cover with a screwdriver.

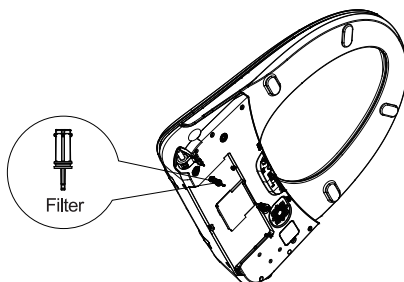

Note: Be careful not to damage the sealing ring, otherwise water may leak.

## Self-cleaning Waterway Maintenance

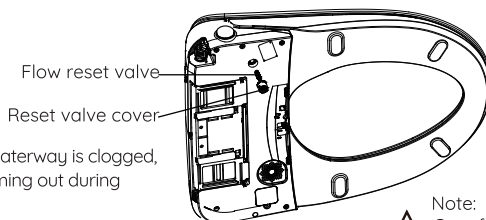

When the self-cleaning waterway is clogged, or if there is no water coming out during self-cleaning process:

1. Turn off the angle valve.
2. Unplug from electrical outlet.
3. Remove the seat, press the flow reset valve in the middle with a flat-blade screwdriver, then reinstall the seat, and turn on the water supply.
4. If there is still no water coming out after pressing the flow reset valve, use a flat-blade screwdriver to unscrew the reset valve cover, remove the flow reset valve, and clean it with a toothbrush or small brush. After cleaning, reinstall the components

Note:  
 Cut off power prior to discharging the water.

## Disassembly and Installation of supply hose

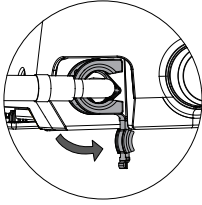

Disassembly: Open the clamp cover, rotate it counterclockwise, and use a flat-blade screwdriver to pry the clamp out of the slot.

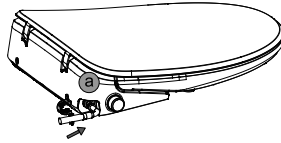

Installation: Push the hose into the quick-connect fitting on the unit. Secure with provided clamp.

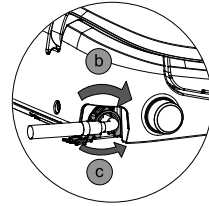

b. Rotate the clamp until the opening faces down.  
c. Close the clamp cover

# Troubleshooting Guide

Problem	Cause	Solution
No water from nozzle	Water supply hose is kinked	Straighten the hose to remove the kink
	Shut-off valve is off	Turn on the shut-off valve
	A water failure occurred	Restore the water supply
Poor water spraying	Water supply hose is kinked	Straighten the hose to remove the kink
	shut-off valve is not fully turned on	Turn on the shut-off valve fully
	Filter is clogged	Clean the filter
Low water temperature	The water temperature is not set properly	Adjust the water temperature
Low seat temperature	The seat temperature is not set properly	Adjust the seat temperature
	Eco mode is on	turn off eco mode and wait 5 minutes
Low dryer temperature	The dryer temperature is not set properly	Adjust the dryer temperature
Spray nozzle cannot retract	Power off	Push back the spray wand gently and turn power on
	Nozzle is dirty	Clean the nozzle
Spray nozzle cannot extend	Power off	Turn on the power
	Seat sensor not engaged	Make sure there is skin contact on seat
Remote control doesn't turn on	The positive and negative direction of the batteries is incorrect	Reload the batteries
Malfunction of deodorization	Seat sensor not engaged	Adjust position on seat to activate the sensor
	Deodorization function continues after user leaves	It is normal for the deodorizing function to continue operating for a few minutes after user leaves
 Caution	If the problem cannot be resolved as per above solutions, please disconnect the power and contact us.	
	If the power leakage protection switch always trips, it means that there may be a defect. Please disconnect the power and contact us.	

Note: it is normal that a new bidet or a bidet unused for a long time may produce a little odor when using the drying function.

Email: [support@alphabidet.com](mailto:support@alphabidet.com)