

Remote Control User Manual

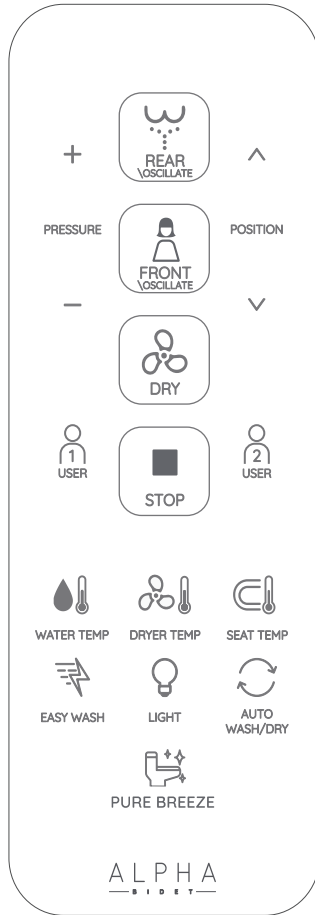

ALPHA
— B I D E T —
UX Pearl

Content

Installation Preparation

01. Remote control installation	01
---------------------------------	----

Usage Instruction

01. Remote control illustration	03
02. Rear/Front cleansing	04
03. Warm air dryer	04
04. Spray pressure adjustment	05
05. Nozzle position adjustment	05
06. Pulse function	05
07. Eco mode	05
08. Easy wash	06
09. Auto wash / dry	06
10. User presets	06
11. Temperature adjustment	07
12. Night light	07
13. Pure breeze	07
14. Other operations	08

Installation Preparation

Remote Control Installation

Remote control hanger installation

(1) Place the remote control wall mount upright where you would like it mounted and mark the two mounting holes with a marker. Drill a hole in each marked position with a 6mm drill bit with a depth of 35mm if using the anchors.

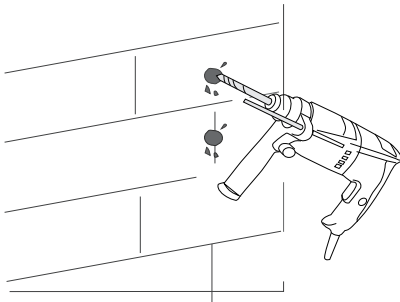

(2) Insert the anchors into the drilled holes. Place the wall mount over the anchors and tighten the screws. The screws can be covered with the included silicone gaskets.

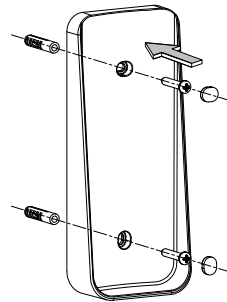

(3) Remove the battery door cover and insert two AAA batteries. Replace the battery cover.



(4) Place the remote control into the wall mount (magnetic).

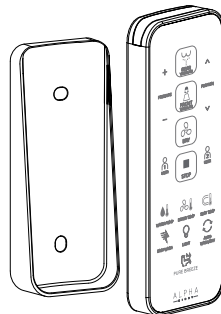

Installation Preparation

Remote Control Installation

Remote control wall mount installation - Option B (tape)

(1) Clean and dry the area you wish to install the wall mount.

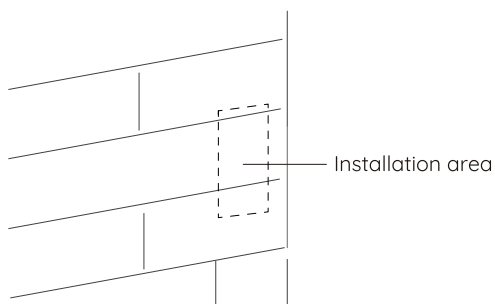

(2) Remove the adhesive tape cover on the back of the wall mount and press the mount firmly against the wall. Hold for 5-10 seconds. The mounting holes can be covered with the included silicone gaskets.

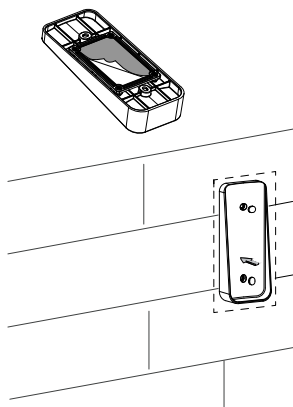

(3) Remove the battery door cover and insert two AAA batteries. Replace the battery cover.

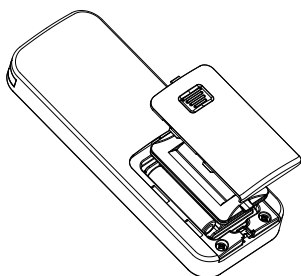

(4) Place the remote control into the wall mount (magnetic).

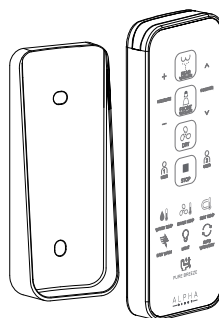

Usage Instruction

Remote Control Illustration

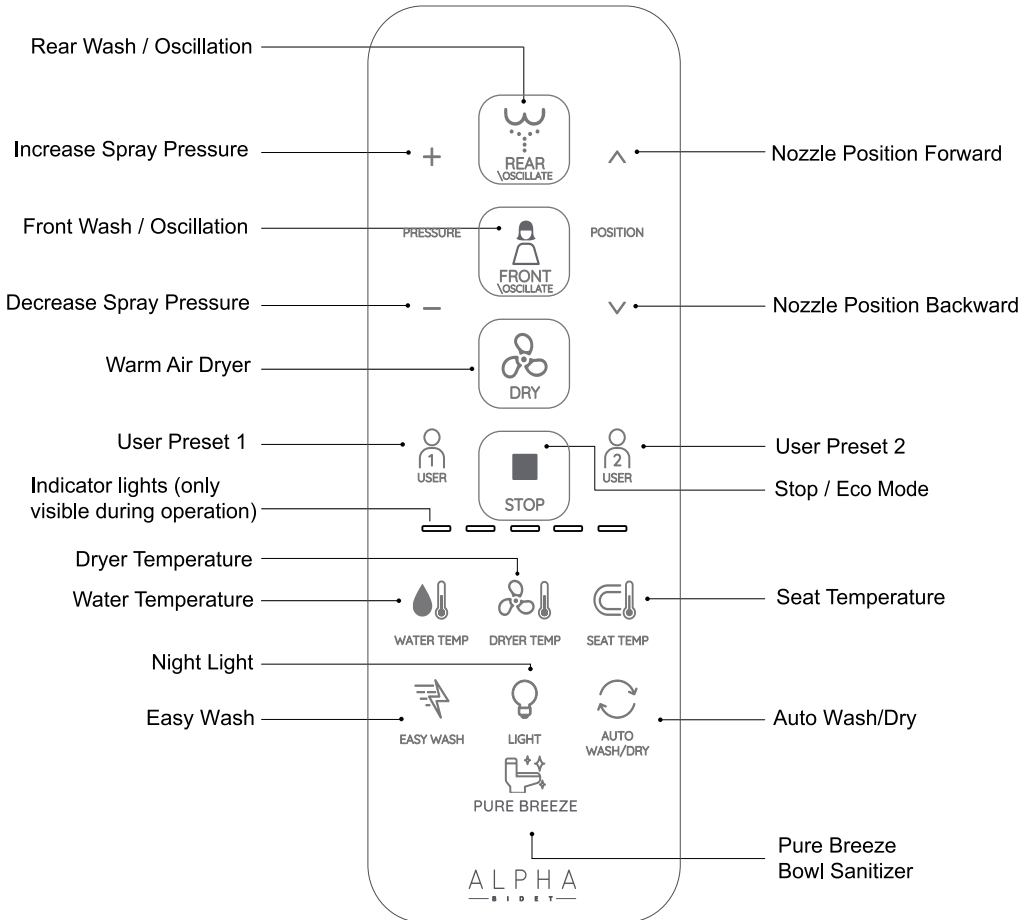

Usage Instruction

Rear / Front Cleansing

- While seated, press the Rear/Oscillate button to activate a rear wash. The indicator lights will appear, showing the current water temperature setting. If you press the Rear/Oscillate button a second time, the nozzle will oscillate back and forth to provide a wider cleaning area. The nozzle will spray for a full wash cycle and then stop. Press the STOP button anytime to end the wash.

- While seated, press the Front/Oscillate button to activate a front wash. The indicator lights will appear, showing the current water temperature setting. If you press the Front/Oscillate button a second time, the nozzle will oscillate back and forth to provide a wider cleaning area. The nozzle will spray for a full wash cycle and then stop. Press the STOP button anytime to end the wash.

Warm Air Drying

· While seated, press the Dry button to begin a dry cycle. The indicator lights will appear, showing the current drying temperature setting. The fan will blow for a full drying cycle and then stop. Press the STOP button anytime to stop the fan.

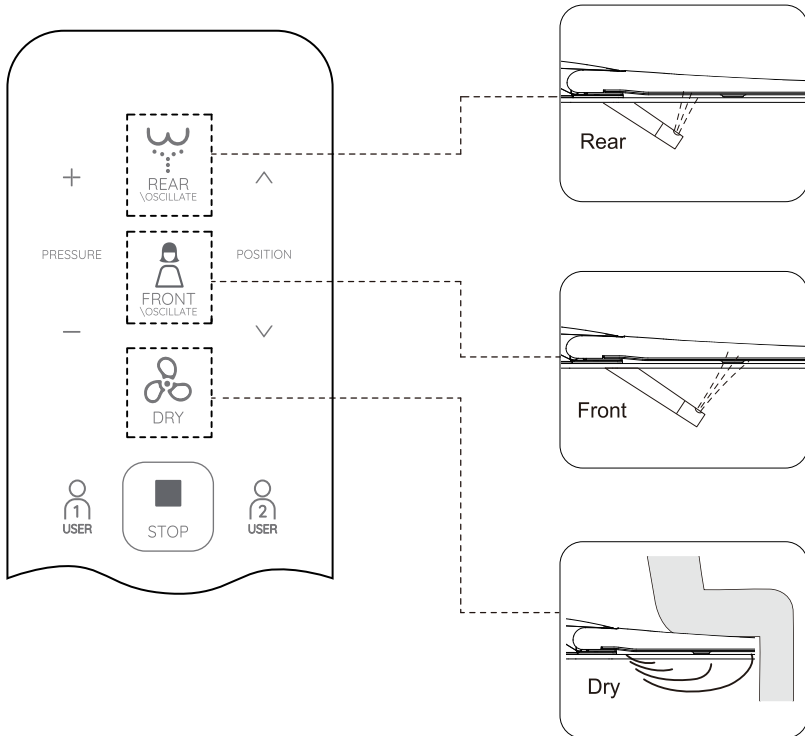

Usage Instruction

Spray Pressure Adjustment

- During either a front or rear wash cycle, press the + button to increase the spray pressure. Press the - button to decrease the spray pressure. During adjustment, the indicator lights will display the current pressure setting.

Nozzle Position Adjustment

- During either a front or rear wash cycle, press the [^] button to adjust the nozzle position forward. Press the [v] to adjust the nozzle position backwards. During adjustment, the indicator lights will display the current position setting.

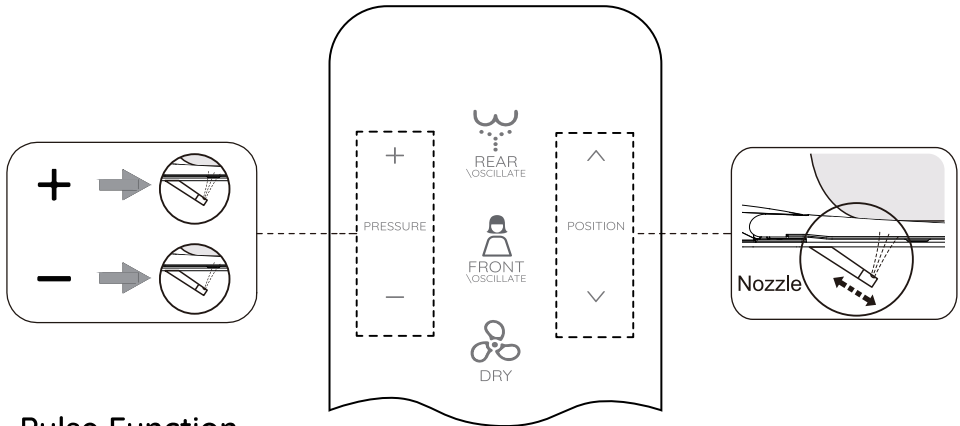

Pulse Function

- During either a front or rear wash cycle, press and hold the current wash button (3 secs) to turn on/off the Pulse spray function.

Eco Mode / Energy Saver

- Press and hold the STOP button for 3secs to turn on/off Eco Mode. The indicator light around the side control knob will slowly fade in and out when Eco Mode is active.

- With Eco Mode enabled, the heated seat temperature will drop to level 1 when idle. The seat will return to the set temperature once a user sits down



Usage Instruction

Easy Wash

- Press EASY WASH to activate an oscillating rear wash at the highest spray pressure.

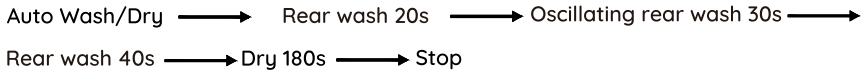

Auto Wash/Dry

- Press the Auto Wash/Dry button to activate a full rear wash cycle, and then a full drying cycle immediately after. Full sequence of events can be seen below. Long pressing and holding the Auto Wash/Dry button will also store the currently set spray pressure, water temperature, dry temperature and nozzle position settings. The stored settings can be used on auto wash/dry function.



User Presets

- The two User Preset buttons can be used to save two different setting profiles. Each profile can store the Spray Pressure, Water Temperature and Nozzle Position settings.

- To save - start a front or rear wash and set the desired Spray Pressure, Water Temperature and Nozzle Position settings. Then, press and hold one of the user profile buttons ( ) until the indicator lights begin to blink. The settings are now stored under that user profile. Repeat the process to save the settings for the second user.

- To use - press the desired user profile you wish to use, then press the front or rear wash to activate a wash. The stored settings can be used on either wash function.



Usage Instruction

Temperature Adjustment

- Water Temperature

Press the WATER TEMP button to adjust the water temperature. The indicator lights will show the current temperature setting. Each press of the WATER TEMP button will cycle through the temperature settings. When the indicator lights are all off, then the water heating is turned off.

- Dryer Temperature

Press the DRY TEMP button to adjust the warm air drying temperature. The indicator lights will show the current temperature setting. Each press of the DRY TEMP button will cycle through the temperature settings. When the indicator lights are all off, then the air heating is turned off.

- Heated Seat Temperature

Press the SEAT TEMP button to adjust the heated seat temperature. The indicator lights will show the current temperature setting. Each press of the SEAT TEMP button will cycle through the temperature settings. When the indicator lights are all off, then the seat heating is turned off.

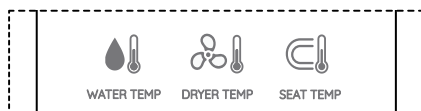

LED Night Light

- Press the LIGHT button to turn on/off the in-bowl LED night light. By default, the LED will either be always on or always off. If you prefer to have your LED only turn on when the bathroom is dark, press and hold the LIGHT button for 3 seconds to activate 'intelligent mode'. Press the LIGHT button again to revert back to the default mode.



Pure Breeze Bowl Sanitizer

- With nobody seated, press the PURE BREEZE button to activate the in-bowl plasma sanitizing function. This function works best with the seat and lid closed.

- Charged air particles are produced and blown around the toilet bowl, helping to neutralize certain microbes and odor particles. The result is a fresher toilet bowl.

- The full cycle will last 10 minutes



Other Operations

Remote Control User Code

- The remote control utilizes IR technology to communicate with the seat. It typically does not pass through walls and households with multiple units generally do not experience interference. In rare cases where interference does occur, you may need to change the remote control user code of the seats.
- Using the remote control near the seat, press and hold the STOP button and then press the REAR button. You will see the indicator lights begin to flash. Use the + and - buttons to select a code channel shown in the indicator lights. Then press and hold STOP and press REAR again to save the setting. If the unit is powered off or the batteries are removed from the remote control, the code will be reset and needs to be changed again.

● ○ ○ ○ ○	○ ● ○ ○ ○	○ ○ ● ○ ○	○ ○ ○ ● ○	○ ○ ○ ○ ●	● ● ○ ○ ○
User 1	User 2	User 3	User 4	User 5	User 6
○ ● ● ○ ○	○ ○ ● ● ○	○ ○ ○ ● ●			
User 7	User 8	User 9			

Quiet Mode

- The seat will beep each time you press a button on the remote control to confirm that they are communicating properly. If you don't hear a beep, then the remote control may not be communicating properly.
- If you wish to turn off the beep noises, you can turn on/off Quiet Mode by pressing and holding the SEAT TEMP button on the remote control.

Auto deodorization

- The seat features a catalytic deodorizer that automatically turns on once a user sits down. This will sound like a low fan in the background. It is on by default, but if you wish to turn the deodorization feature off, press and hold the STOP button and press the FRONT button. Do it again to turn it back on.

Seat Sensor

- The seat's wash and dry functions will not operate unless someone is seated. The seat has a skin sensor (not weight) near the 4 o'clock area of the seat. For testing purposes, you can place a wet paper towel over this area of the seat to engage the sensor.
- When you first sit down, you may hear a click sound and some water dripping into the bowl. This is the nozzle initializing and preparing for use.

Email: support@alphabidet.com