



BB600

OWNER'S MANUAL





PRODUCT INFORMATION

Important Safeguards.....4
Cautions Before Installation.....6
Safety Information.....8
Main Unit & Parts.....10

PRODUCT INSTALLATION

Installation.....11
Testing.....14

PRODUCT OPERATION

Operation.....15
Cleaning.....19
Maintenance.....21
Troubleshooting Guide.....24
Specifications.....26

WARRANTY

Warranty.....28



READ ALL OPERATING INSTRUCTIONS BEFORE INSTALLATION

- This product should be installed according to this manual.
- Read this manual carefully and install properly.
- Do not attempt to service this appliance yourself.
- Doing so will void the warranty.

READ ALL INSTRUCTIONS BEFORE USING

DANGER - TO REDUCE THE RISK OF ELECTRIC SHOCK:

- Do not place or store this appliance in a location where it can fall or be pulled into a tub or sink.
- Do not place in, or drop into water or other liquids.
- Do not touch a product that has fallen into water. Unplug immediately.

WARNING - TO REDUCE THE RISK OF BURNS, ELECTRIC SHOCK, FIRE, OR INJURY

- Close supervision is necessary when this appliance is used by or is near infants, elders, or handicapped persons. Children should not be permitted to use or touch this appliance without adult supervision. Be sure to adjust the toilet seat's temperature for elders, handicapped persons, or people with sensitive skin.
- Use this appliance only for its intended purpose as described in this manual. Do not use attachments not recommended by the manufacturer.
- Do not operate this appliance if the cord is damaged or if the product is dropped into water.
- Install the unit properly by following the installation procedure.
- Only authorized persons can install or repair the unit. Do not attempt to service this appliance by yourself. Doing so will void the warranty.
- Keep the cord away from heated surfaces.

- Never drop or insert any objects into any opening or hose.
- Do not use outdoors. Do not use aerosol or oxygen spray products on the unit.
- Always follow the grounding instructions in this manual before plugging in the unit.

SAVE THESE INSTRUCTIONS



NOTE THE FOLLOWING IMPORTANT POINTS

- Do not install in a location where water might be splashed on this appliance or in a location exposed to excessive moisture where condensation might form on the product's surface.
- To avoid damage to electronic components due to high levels of humidity, provide adequate ventilation by opening a window and/or door when bathing.
- Water supply should have a water pressure of 0.08 MPA to 0.75 MPA
- Connect the product to a pipe carrying potable water. Do not connect to an industrial water line or other water supplies that are not potable.
- Bring the unit to room temperature.
- The thermal protector in the water tank may malfunction when transporting or storing warm water.
- The rated power voltage in AC 120V, 60Hz
- Do not plug the unit in, until installation is complete. It may result in malfunction.

WIRING REQUIREMENTS

- Any other servicing should be performed by authorized service representatives.
- **GROUNDING INSTRUCTIONS** - This product should be grounded. In the event of an electrical short circuit, grounding reduces the risk of electric shock by providing an escape wire for the electric current. This product is equipped with a cord having a grounding wire with a grounding plug. This plug must be plugged into an outlet that is properly installed and grounded.

DANGER - IMPROPER USE OF THE GROUNDING PLUG CAN RESULT IN A RISK OF ELECTRIC SHOCK.

- If the cord or plug is necessary to repair or needs to be replaced, do not connect the grounding wire to a flat blade terminal. The grounding wire can be identified by its insulated outer surface. It will either be colored green or will not contain yellow stripes. Check with a qualified electrician or serviceman if you do not understand grounding instructions or if you do not know whether the product is properly grounded.
- This product is for use on a nominal 120V circuit. It has a grounding plug that looks like the plug illustrated in sketch A. A temporary adapter, which looks like the adapter illustrated in sketches B and C, may be used to connect this plug to a 2-pole receptacle as shown in sketch B if a properly grounded outlet is not available. The temporary adapter should be used only until the properly grounded outlet (sketch A) can be installed by a qualified electrician. The green colored rigid ear, lug and the like extending from the adapter must be connected to a permanent ground such as properly grounded outlet box cover. Whenever the adapter is used, it must be held in place by the screw.

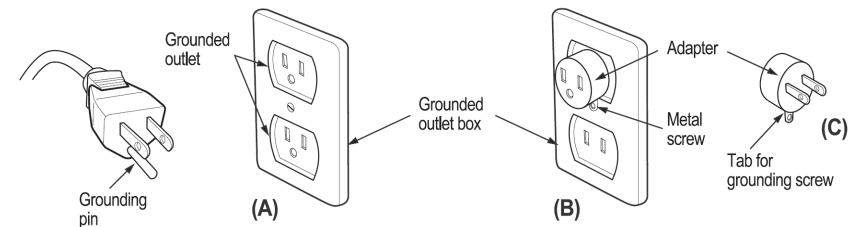

- If it is necessary to use an extension cord, use only a three wire extension cord that has a three-blade grounding plug, and a three-slot receptacle that will accept the plug on the product. Replace or repair a damaged cord.



FOLLOW THESE BASIC INSTRUCTIONS TO ENSURE THE SAFE USE OF YOUR APPLIANCE.

DANGER

- **DO NOT use a faulty or loose electric outlet or cord.**
Doing so may result in a short circuit, electric shock, or fire.
- **DO NOT obstruct the warm air dryer outlet.**
If the outlet is obstructed with any objects, it may result in fire.
If the outlet is obstructed with hands, it may result in injury.
- **DO NOT throw anything flammable into the toilet.**
Doing so may result in fire.
- **DO NOT splash water on this product.**
Doing so may result in fire or electric shock.
- **DO NOT use too many appliances on one power strip.**
Doing so may result in fire or damage.
Be sure to use a dry and clean outlet.
Do not use a faulty or loose outlet.
- **DO NOT use when the seat and lid are disassembled.**
Doing so may result in electric shock due to high voltage inside.
- **DO NOT disassemble, repair, or modify this appliance.**
Doing so may result in fire or electric shock.
- **Plug and unplug properly.**
Do not plug or unplug with wet hands. It may result in injury or short circuit. Do not grab the cord when unplugging. Pull out the plug properly.
- **Unplug when beeping or emitting a strange odor.**
Unplug right away. Contact your dealer where you bought this appliance.
- **Use tap potable water only (ground water)**
Not doing so may cause irritation or injury.
- **This product must be grounded.**
Not doing so may result in short circuit, electric shock, or malfunction.

WARNING

- **DO NOT step on or place heavy objects on this appliance.**
Doing so may damage the unit.
Doing so may result in malfunction of appliance.
- **DO NOT force the lid to close.**
Doing so may cause malfunction.
- **DO NOT sit or lean against the lid or control panel.**
Doing so may cause malfunction or breakage.
- **DO NOT pull out the water hose forcefully.**
Doing so may cause water leakage.
- **DO NOT put a vase, water cup, or small materials on this appliance.**
- **Be aware of low-grade burns.**
Sitting on the heated seat for a long time may result in a low-grade burn.
Use care when being used by the following: Children, senior citizens, patients, or others who can not control the temperature level. Sleeping pill users or people who are on medication that causes drowsiness. Those who are intoxicated or very tired may fall asleep while sitting on the unit.
- **Unplug when cleaning.**
Not doing so may result in fire or electric shock.
- **Use the low temperature for children and disabled.**
High temperature may result in burns due to not recognizing the temperature.
- **Use this appliance on a toilet only.**
Not doing so may result in fire, injury, or electric shock.
- **Unplug if you do not plan to use for long periods of time.**
- **Unplug while there is a thunder or lightning.**
- **Be aware of urine splash on a nozzle or on a dry air outlet.**
Doing so may result in unpleasant odor or failure of appliance.

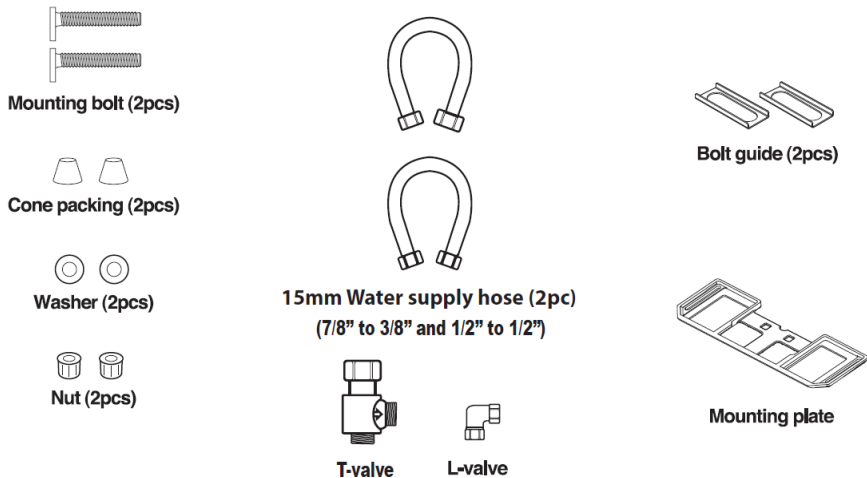
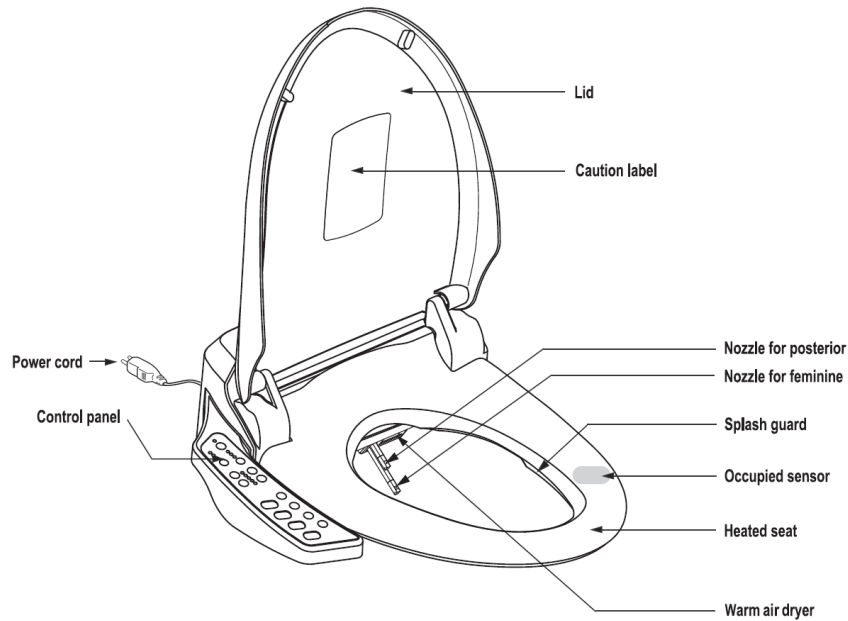

DO NOT PLUG IN UNTIL INSTALLATION IS FINISHED COMPLETELY. NOT DOING SO MAY DAMAGE THE APPLIANCE.

IF ELECTRIC WORK IS NEEDED, PLEASE CONTACT TO THE QUALIFIED ELECTRICIAN OR SERVICEMAN ONLY.

REMOVE THE EXISTING TOILET LID AND SEAT

- Remove the nuts, washers and cone packings from the toilet seat mounting bolts in the back of the toilet.
- Remove the toilet seat, lid, and mounting bolts.
- Keep them in case of need.

TOILET SIZE (ELONGATED & ROUND FRONT)

- The toilet dimensions must be within those shown. Do not install this appliance on a toilet that does not meet those dimensional requirements.

OCCUPIED SENSOR

- This appliance is equipped with an occupied sensor.
- Unit will not work unless the seat is occupied.

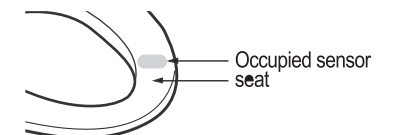
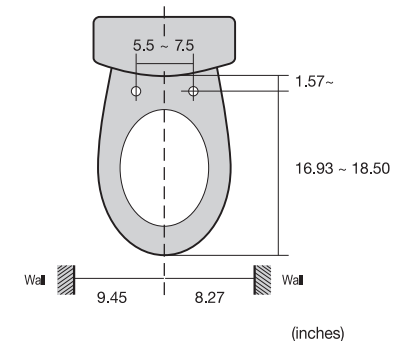



NOTE:

This product is designed and intended for use exclusively with Bio Bidet USPA water filters. The purchase or use of any other water filter is not the responsibility of Bio Bidet Innovation LLC. As such, any use of non USPA water filters is prohibited and will void the warranty for those Bio Bidet products. Bio Bidet will not be responsible for any resulting damages or claims related to the misuse or distribution of non Bio Bidet Uspsa filters.

1. HOW TO MOUNT THE PLATE

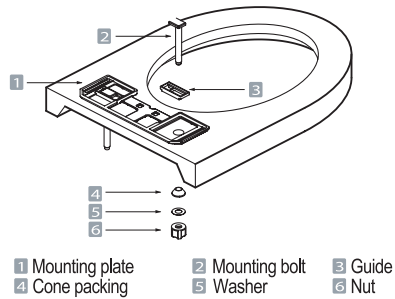

- 1 Mounting plate
- 2 Mounting bolt
- 3 Guide
- 4 Cone packing
- 5 Washer
- 6 Nut

- Place the plate and guides over each mounting hole. Insert the mounting bolts through the plate and mounting holes, and slide cone packings and washers onto the bolts.

2. HOW TO ATTACH AND DETACH THE UNIT

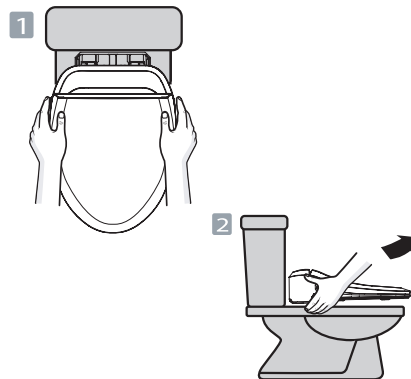

- Slide the unit until it clicks onto the plate.
- Lift the unit up and forward to detach.

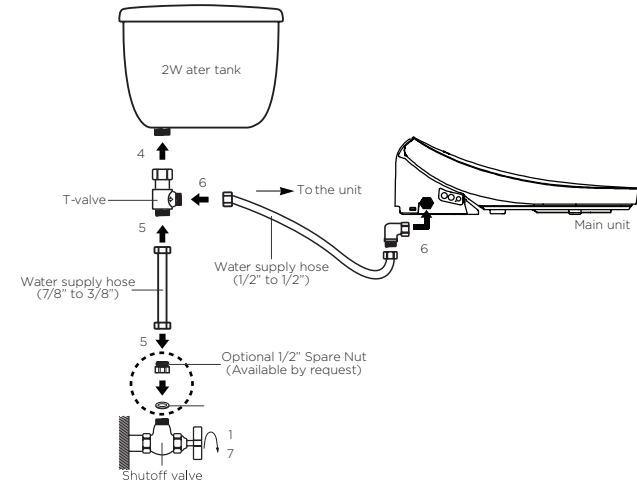

- Close the shutoff valve by turning it clockwise.
- Then flush the water tank completely to empty it.
- Remove the existing water supply hose from the water tank.
- Install the T-valve on the water tank.
- Connect one end of the water supply hose (7/8 to 3/8) from the T-valve to the shutoff valve.
- Connect the other end of the water supply hose (1/2 to 1/2) from the T-valve to the main unit.
- Open the shutoff valve by turning it counter clockwise.
- Check for any water leaking or dripping.

Using an In-line Carbon Filter

The use of an external in-line carbon water filter is not required unless the unit is used in an area with extreme hard water. If a carbon filter is used, the filter must be replaced every 6 months. in-line carbon filters can be purchased from any authorized Bio Bidet reseller.

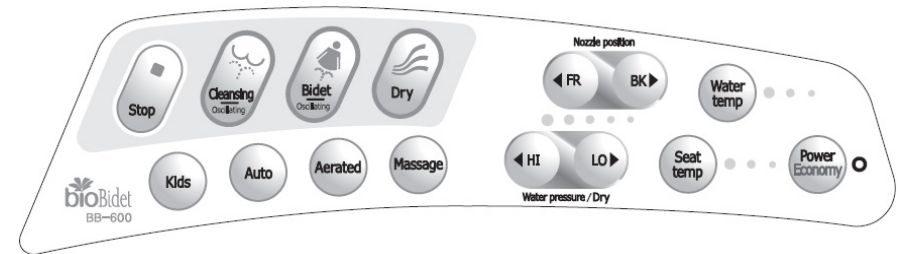
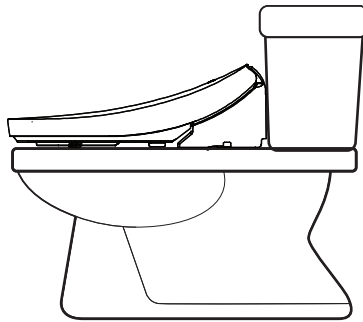

- Plug the power cord into the outlet, and then the water tank will be filled with water in 2 minutes.
- Check all the functions. Cover the toilet using the sheet of plastic wrap on the unit to prevent the washing water from being sprayed out of the toilet. Then check for all functions described in this manual.
- There are possibilities of water coming out that remains in the unit while heating.

CAUTION

All functions will be operational when the seat is occupied except Nozzle Cleaning and Power/Economy.

Before operating, ensure that water tank is filled completely.

- When the power is plugged in initially, nozzles for feminine wash and posterior wash will come out in turn.
- Before operating, ensure that the water tank is filled up completely.

STOP

- Press “Stop” to stop current operation.
- When a user stands up, all operations will stop automatically.

CLEANSING

- Press “Cleansing” to clean your posterior. The function will stop in 1 minute automatically.
- Press this button again to activate oscillation. The nozzle moves back and forth automatically to widen cleansing area.
- Oscillation wash stops if this button is pressed again.



BIDET

- Press “Bidet” for feminine wash. The function will stop in 1 minute automatically.
- Press this button again to activate oscillation. The nozzle moves back and forth automatically to widen cleansing area.
- Oscillation wash stops if this button is pressed again.

DRY

- Press Dry after Cleansing or Bidet. Warm air will be emitted for 3 minutes.
- To alter the strength of air drying, press this button again.

KIDS

- Press “Kids” to change all functions to be suitable for children.
- 1 minute of oscillation and 3 minutes for dry, level 1 of water pressure and level 5 of nozzle position will be set.
- This unit should be used under the supervision of an adult.

AUTO

- Press “Auto” during “Cleansing” operation, wash, oscillating and dry will operate for 20 seconds per each function. If Bidet Auto is wanted, press “Bidet” and “Auto” consecutively.

AIR (AERATED SPRAY)

- Press “Air” to use aerated wash to clean. Gentle delicate but strong water spray will save water consumption.
- Press this button again to release this function.
- “Cleansing” This function is always on.

PULSATION (MASSAGE)

- Press “Pulsation” to activate rhythmic wash for massage effect.
- Press “Pulsation” again to release this function.

NOZZLE POSITION

- Nozzle position can be adjusted by pressing the nozzle position buttons.
- Position will be initialized (level 3) after each use.

WATER PRESSURE/DRY TEMPERATURE

- Water spray pressure and temperature of dryer can be adjusted by pressing arrows in 5 levels.
- Both levels will be initialized (level 3) after each of use.

TEMPERATURE ADJUSTMENT (WATER/SEAT)

- Temperature of seat and water can be adjusted.
- There are 4 levels, Room Temp, Low, Medium, High).

SILENT MODE

- To disable the beeping, press the hold the Posterior button on the side panel without sitting on the seat for 2 to 3 seconds until you hear a series of short beeps. To enable, repeat these steps until you hear a single long beep.

SELF CLEANING

- This appliance automatically cleans its nozzles before and after each use.



ECONOMY

- Press “Economy” to activate the power saving function. The unit will be in an economy mode after 1 hour of last use.
- In the economy mode, temperature of water and seat will be kept to 30°C. Economy mark (bulb) on the remote control and green light in an extra panel will be shown.
- When the unit is occupied during the economy mode, temperature will be returned to original setting levels and goes back to economy mode after 1 hour of last use.
- Press “Economy” again to release this function. Red light will be turned on in the extra panel.

SELF-DIAGNOSIS SYSTEM

- This appliance has a self-diagnostic system, whenever the appliance has a problem(s), the LED power light on the unit will start flashing.
- Unplug and contact service center immediately.

NOZZLE CLEANING

Do not forcefully push or pull the nozzles or bend them. It may result in failure.

- Make sure the occupied sensor is not activated. (Do not sit on the seat or place hands on the seat sensor).
- Press “FR” button on control panel. Posterior (cleansing) nozzle comes out. Press “BK” button on control panel. Feminine (bidet) nozzle comes out.
- Do not force to push or pull the nozzles or bend them.
- Use a toothbrush or soft cloth to clean nozzles.
- Press “Stop”, and nozzle will return to stand-by mode. Beware of lost tips. Do not retract nozzles without a nozzle tip. It may result in malfunction.

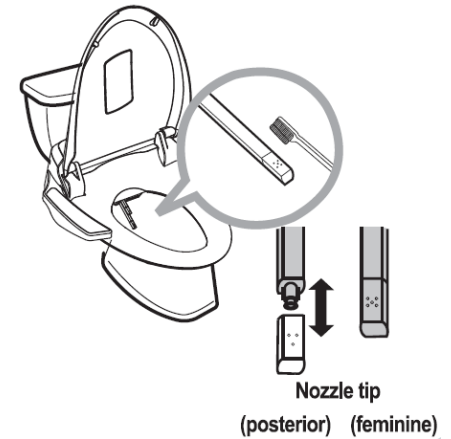

CLEANING THE BODY

- Regularly wipe off the body with a dry soft cloth or sponge, or wash with a damp cloth and mild detergent.
- For care of plastic body, do not use any cleansers such as toilet cleanser, home cleanser, bleach, benzene, paint thinner, cresol, etc.





STRAINER MAINTENANCE

This appliance will not operate properly if the strainer is clogged. Be sure to clean the strainer regularly.

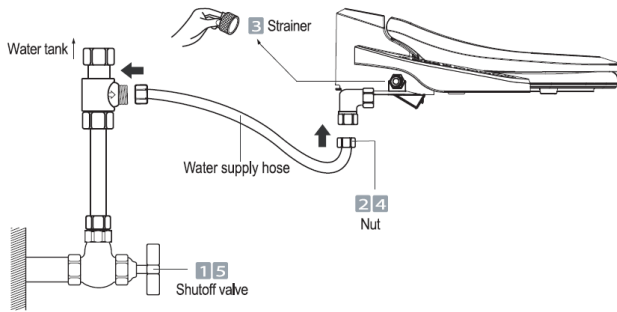

- Close the shutoff valve by turning it clockwise.
- Unscrew the nut.
- Clean the strainer with a small brush.
- Re-screw the nut.
- Open the shutoff valve by turning it counter clockwise.

DRAINING WATER (WHILE NOT USING OVER EXTENDED PERIOD OF TIME)

1. UNPLUG POWER SUPPLY CORD

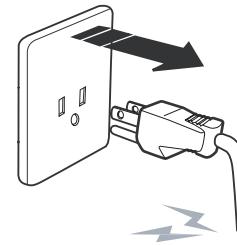

- Not doing so may cause fire.

2. CLOSE SHUTOFF VALVE

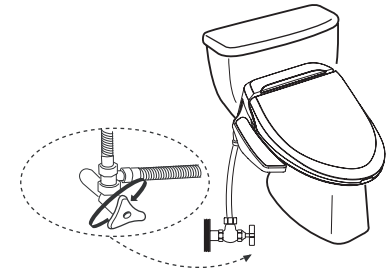

3. UNSCREW MOUNTING BOLTS



- Refer to the installation method.



4. DRAIN WATER

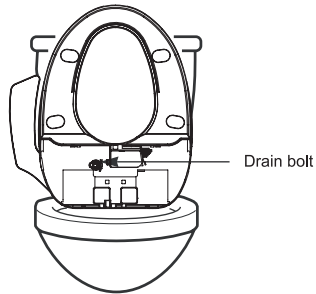

- Uphold the appliance and thoroughly drain the water by unscrewing the drain bolt. (beware of losing the drain bolt.)
- The figure shown is only to check the location of 'Drain bolt' To prevent malfunction, do not place the vertical position or tilt the product.

5. INSTALL

- Screw the drain bolt and install the appliance.
- Refer to the trial operation method in order to use this appliance again.

PREVENTING FREEZING

1. PLUG THE POWER CORD IN PROPERLY

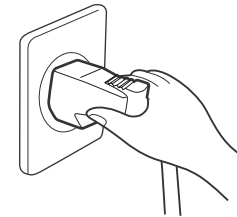

2. SET THE TEMPERATURE OF WATER TO LOW OR MIDDLE

- Freezing can be prevented by thermal efficiency of the water tank.
- If there is no heating system in the toilet, wrap pipes with cloth or other materials.

3. DRAIN THE WATER

- If the unit has not been used for a long time during winter, please unplug and drain the water from the water tank and pipes thoroughly.
- Refer to the water drain method.



PROBLEM	POSSIBLE CAUSE	POSSIBLE SOLUTION
Stops in the middle of use	<ul style="list-style-type: none"> Washing or drying exceeded cycle time Skin sensor lost contact Clogged nozzle tip 	<ul style="list-style-type: none"> Press the wash or dry mode again Activate the skin sensor with full skin contact through the entire cleansing period Clean the nozzle tip
Water coming out from the nozzle unexpectedly	<ul style="list-style-type: none"> Self-cleaning 	<ul style="list-style-type: none"> The unit will self-clean the nozzle before and after each use automatically.
Water leaking continuously	<ul style="list-style-type: none"> Leaking from hose connection at the unit Leaking from the T-valve Leaking from behind or under the tank. 	<ul style="list-style-type: none"> Check to make sure that all rubber washers are in place and do not over tighten the connection but it should be secure Check to make sure that the rubber washer is in place with the flat side pointing up. Check that the drain is not opened on the unit if the unit continues to leak, immediately disconnect it from the water supply, drain the tank, and contact the Bio Bidet Innovation LLC service center.

PROBLEM	POSSIBLE CAUSE	POSSIBLE SOLUTION
Unit completely fails to work or power on	<ul style="list-style-type: none"> Power outage Unit is not plugged in Faulty receptacle Skin sensor is not activated 	<ul style="list-style-type: none"> Reset the GFI outlet Plug the power cord in to a GFI outlet Test another appliance in the outlet Activate the skin sensor on the unit
Nozzle	<ul style="list-style-type: none"> Remote control is not working Nozzle is dirty External bidet filter Skin sensor is not activated Seat riser is covering the skin sensor 	<ul style="list-style-type: none"> Replace the remote control batteries. Try not to cooperate the unit with the side control panel Clean the nozzle Remove the external bidet filter Activate the skin sensor on the unit The seat riser must go underneath the bidet seat.
Low water pressure	<ul style="list-style-type: none"> Clogged nozzle tip Water pressure is set to low on remote 	<ul style="list-style-type: none"> Clean the nozzle tip Raise the water pressure on the remote control
Seat is not heating	<ul style="list-style-type: none"> Unit is set on Economy Mode 	<ul style="list-style-type: none"> Turn off the Economy Mode Unplug the unit for 10 seconds



ITEM		BB-600
Standard Power Supply		AC 120V 60HZ 600W
Water Supply	Spray for cleansing	Direct connection to tap water
	Water pressure	0.08MPa - 0.75 MPa
Cleansing	Spray for cleansing	900 +/- 100ml/min
	Spray for bidet	900 +/- 100ml/min
	Water capacity	800ml
	Spray temperature	Room Temp - 40°C (104°F)
	Heater capacity	600W
	Safety feature	Thermal switch, Temperature fuse, Floating switch
Dry	Air Temperature	Room temp - 40°C (104°F)
	Heater capacity	250W
	Safety feature	Temperature fuse
Heated Seat	Seat temperature	Room temp - 40°C (104°F)
	Heater capacity	55W
	Safety feature	Temperature fuse
Circuit breaker		Within 15mA 0.03 second
Length of power cord		1.2m
Dimensions		(W) 466mm (18.34 inches) X (L) 520mm (20.47 inches) X (H) 145mm (6.71 inches)
Weight		4.4Kg (9.7lbs)

* Recommended water supply pressure are 0.1 - 0.69 MPa.

* The minimum available water supply pressure is 0.08 MPa however under 0.1 MPa pressure, water spray might not be adequate.



BIO BIDET PERSONAL HYGIENE APPLIANCE LIMITED WARRANTY

We warrant our products to be free from manufacturing defects under normal use and service for a period of 2 years prorated base as below from the date of your purchase.

- 100% Coverage of all parts and labor for the entire product for the first year from original date of purchase
- 75% Coverage of all parts and labor for the entire product for the second year from original date of purchase.
- 50% Coverage of all parts labor for the entire product for the third year from original date of purchase.

Warranty is valid within the United States and Canada only.

Our obligation to you under this warranty is limited to repair or replacement, at our option, of defective products or parts, provided that the products were properly installed and used in accordance with instructions. We reserve the right to make inspections in order to determine the cause of the defect. We will not charge for labor or parts in connection with warranty repairs or replacement. We are not responsible for the cost of removal, return and/or re-installation of products.

This limited warranty does not apply to:

- Damage or loss from a fire, earthquake, flood, storm, etc.
- Damage or loss resulting from any unreasonable use, abuse, negligence, or improper maintenance.
- Damage or loss from improper installation, removal, or modification.
- Damage or loss resulting from sediment or other matters contained in your water system.

This warranty gives you specific legal rights.

For warranty or service information, please contact your dealer where you bought this appliance or Bio Bidet.

Only the original purchaser may submit a claim under this limited warranty.

This limited warranty is our only warranty covering your product. Repair or replacement as provided under this warranty shall be the exclusive remedy available to you. We shall not be responsible for loss of the product or for other incidental, or consequential damage or expenses you may incur or for labor or other costs due to installation or removal, or cost of repairs by others, or for any other expense not specifically stated above. Except to the extent prohibited by applicable law, any implied warranties, including that of merchantability or fitness for use, are expressly limited to the duration of this warranty.

WARNING! We are not responsible or liable for any failure of, or damage to, this plumbing product or product component caused by in-tank bowl cleaners containing chlorine (calcium hypochlorite).

NOTE: The use of high concentration of chlorine related products can seriously damage the fittings. This damage can cause leakage and serious property damage.

For more information, please contact your dealer or us.

BIO BIDET INNOVATION LLC

7900 S RT 31 Crystal Lake IL 60014

T: 847.458.2334

F: 847.854.1296

Email: support@biobidet.com

biobidet.com

Updated

9/27/21

Thank You



Technical Support/Customer Service
7900 S Route 31 Crystal Lake, IL 60014
T: 847.458.2334
U.S. TOLL FREE: 877.339.5214

support@biobidet.com
biobidet.com