

Emergency & Rescue Catalogue 2012/13





| | | | |
|-----------------------------|----|---------------------------|-----|
| Product Index | 2 | Casualty Room | 60 |
| Patient Handling | 4 | CPR / Rescue Manikins | 62 |
| Immobilisation | 25 | Rescue Stretchers | 68 |
| Trauma / Airway Kits | 36 | Tactical Evacuation | 80 |
| Airway / Oxygen | 41 | Edge / Rope Rescue Gear | 92 |
| Defibrillation / Diagnostic | 47 | Rope / Rope Care Gear | 112 |
| BLS / ALS Packs & Cases | 49 | Rescue Tools / Knives | 119 |
| Vehicle Management | 58 | Disaster / PPE / Lighting | 124 |



Ferno Australia

Head Office
11 Johnstone Road
Brendale Qld 4500
Australia

Call toll free
1800 804 647

p +61 7 3881 4999
f +61 7 3881 1125

VIC
18 Damosh Avenue
Carrum Downs VIC 3201

p +61 3 9775 1260
f +61 3 9775 1360

WA
22 Casella Place
Kewdale WA 6105
p +61 8 9353 2300
f +61 8 9353 1169

www.ferno.com.au

 **FERNO**
Australia

Contents

Patient Handling

(Page 4 to 24)

Ambulance Stretchers
Bariatric Stretchers
Patient Restraints Systems
Stretcher Accessories
Emergency Stretchers
Stair Chairs
Patient Transfer
Patient Evacuation
Infant Transport

Immobilisation

(Page 25 to 35)

Scoop Stretchers
Backboards / Spineboards
Restraint Systems
Extrication Devices
Vacuum Mattresses
Cervical Collars
Head Immobilisers
Traction Splints
Vacuum Splints
Pelvic Sling
Splints

Trauma / Airway Kits

(Page 36 to 40)

Burn Kits
BLS / ALS Kits
Resuscitation Kits
Ventilation Kits
Intubation Kits

Airway / Oxygen

(Page 41 to 46)

Bag Mask Resuscitators
Pocket Mask
Oxygen Regulators
Demand Valves
Ventilators
Suction
Chest Seal
Ancillary

Defibrillation / Diagnostic

(Page 47 to 48)

Defibrillators
Pulse Oximeter
Otoscope

BLS / ALS Packs & Cases

(Page 49 to 57)

First Aid Cabinets Metal
First Aid Cases Plastic
EMS Hard Cases
Glove Pouches
First Aid Pack Fabric
Trauma / EMS Packs
Vests & Holsters
Specialty Modules

Vehicle Management

(Page 58 to 59)

Acetech System

Casualty Room Equipment

(Page 60 to 61)

Medical/Instrument Trolleys
Bin
Stools
Privacy Screen
Lamp
Couches

CPR / Rescue Manikins

(Page 62 to 67)

CPR Manikins
IV / Airway Manikins
Rescue Manikins

Rescue Stretchers

(Page 68 to 79)

Basket Stretchers
Rescue Stretchers
Accessories
Litters

Tactical Evacuation

(Page 80 to 91)

Litter Transport
Litter Platforms
Litter Accessories
Vehicle Platforms
Equipment Mounting Solutions
Ladders

Edge / Rope Rescue Gear

(Page 92 to 111)

Arachnipod Edge Management System
Tripods / Davits
Rescue / Descent Kits
Descenders / Ascenders
Rope Grabs
Belays / Pulleys
Karabiners / Connectors
Harnesses

Rope / Rope Care Gear

(Page 112 to 118)

Rope
Rope Care
Gloves / Bags
Slings

Rescue Tools /Knives

(Page 119 to 123)

Cutters / Spreaders
Rams
Pumps
Lifting Bags
Glass Maintenance Kit
Hand Tools
Knives

Disaster / PPE / Lighting

(Page 124 to 132)

Lighting
Triage
Seat
Body Bags
Toilet Kits / Waste Treatment
Smoke Filters and Masks
Elbow & Knee Pads
Helmets
PFD
Whistle
Books / Manuals
Nitrile & Latex Gloves
Surface Disinfectant Solution
Cool Vests

We care for those who care

Ferno developed the first one-man stretcher over 50 years ago.

We've been bringing you cutting-edge products ever since. No one can predict when emergencies will happen. But Ferno can help you prepare for it. We've manufactured and sourced a complete suite of products for ambulance, emergency medicine, rescue and safety. We firmly believe we're bringing you the very best available - the only Australian company offering you such depth of choice.



The Ferno difference

Well-designed and well-built products are our cornerstones. We do all we can to ensure the products we offer are consistently reliable and suited to the job. That includes listening to industry when developing new products and continually refining them after launch to make them even better.

With Ferno you get the best of both worlds - international expertise and resources, enhanced with local knowledge and accessibility. A dynamic pair from our founding family - Scott West and Alan Ferris, manages Ferno Australia. They bring decades of experience and stability and uphold Ferno's tradition of strong customer and after-sales service. Because when it's critical, you can count on Ferno.



Stretchers & Patient Handling

Providing safe patient packaging is what we built the Ferno name on.

Over the decades since we designed the world's very first one-man stretcher, we've continued working with front line responders to develop and engineer award-winning equipment that not only meets Australian Standards but also performs exactly how you expect it to, when you want it to. Ferno-made products undergo thorough design and manufacturing processes and are rigorously tested both in-house and via external agencies.

We've used our experience and industry knowledge to sift through the profusion of patient handling equipment to bring you the very best available. From sophisticated power-assisted Ferno stretchers and stair chairs, to basic no-frills patient handling gear – all are tried and true equipment; chosen because they meet the patients' needs and help you do your job more effectively.



Ferno Mondial Monobloc

The Mondial Monobloc has been designed with Ferno Smart-Load, system technology to make your job easier with smooth, simple, ergonomic operation of the transporter when loading and unloading from an ambulance, and when lifting or lowering a patient.

Key features

- Smooth, safe and easy loading and unloading with the exclusive EZ Load, auto-release system
- Ergonomically designed front and rear leg automatic release mechanism that allows the operators to engage the control handle first, before assuming the weight of the cot during loading and position changes
- Intermediate loading wheels reduce the amount of friction when loading and unloading from an ambulance
- Control handles not required when loading into an ambulance or raising the transporter to a higher position
- Lift assistance on heavy patient loads with side, head and foot end handles (side handles optional)
- Easy rolling over all types of terrain with large 150 mm wheels
- Tight space maneuverability with on demand four swivel wheel lock/release mechanism
- Easy patient transfer with six bed positions and a folded position
- Nighttime visibility with reflective labels
- 3 position shock frame with contour feature
- Gas assist backrest
- 3-Position swing-down sidearms
- Low-bed leg lock allows transporter to be carried like a litter (optional)
- Head end extension for taller patients or patients with leg splints (optional)
- Under backrest storage tray (optional)
- Choice of red, green, or silver transporter legs
- Safety Lock Device SLD (optional)



Mattress and restraints sold separately



Optional EZ Load system with safety lock device



150 mm swivel wheels with lock

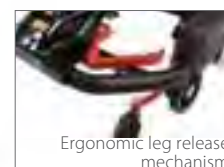

Ergonomic leg release mechanism



3 stage swing down side arm



Optional side lift handle

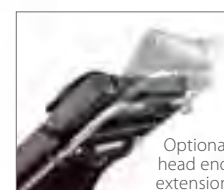

Optional head end extension

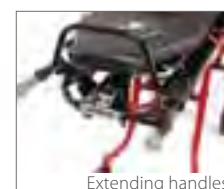







Extending handles

Product Specifications

| Model | Code | Length | Width | Height Max | Loading Height | Weight | Load Limit |
|----------------|-----------|---------|--------|------------|----------------|--------|------------|
| Monoblock MB64 | FWE-MB64S | 1950 mm | 550 mm | 949 mm | 670-730 mm | 45 kg | 280 kg |
| Monoblock MB70 | FWE-MB70S | 1950 mm | 550 mm | 1007 mm | 740-790 mm | 45 kg | 280 kg |

Optional Accessories

| 417 Adult Harness | QR PediMate | Baby Capsule Harness | IV Pole | Stretcher Cover | Mattress | Floor Lock |
|---|---|---|---|--|---|---|
|  |  |  |  |  |  |  |
| BRH-417-50 | BRH-678-QR | BRH-419 / BRH-420 | 083-2024 | FWESC | 037-4874 | 0573080 |

Ferno Mondial Transporter™ with RS-2 Lift-Off Stretcher

The Mondial Series have been designed with Ferno Smart-Load, system technology to make your job easier with smooth, simple, ergonomic operation of the transporter when loading and unloading from an ambulance, and when lifting or lowering a patient.

Key features - Transporter

- Smooth, safe and easy loading and unloading with the exclusive EZ Load, auto-release system
- Ergonomically designed front and rear leg automatic release mechanism that allows the operators to engage the control handle first, before assuming the weight of the cot during loading and position changes
- Intermediate loading wheels reduce the amount of friction when loading and unloading from an ambulance
- Control handles not required when loading into an ambulance or raising the transporter to a higher position
- Lift assistance on heavy patient loads with side, head and foot end handles
- Easy rolling over all types of terrain with large 100 mm wheels
- Tight space maneuverability with on demand four swivel wheel lock/release mechanism
- Easy patient transfer with six bed positions and a folded position
- Low-bed leg lock allows transporter to be carried like a litter
- Nighttime visibility with reflective labels
- Choice of red, green, or silver transporter legs
- Safety Lock Device SLD (optional)

Key features - Lift-Off Stretcher

- 3 position shock frame with contour feature
- Head end extension for taller patients or patients with leg splints
- Reversible patient loading: head first or feet first
- Under backrest storage tray
- Four 100 mm wheels
- Gas assist backrest



RS-2 Lift-Off Stretcher



Ferno Mondial™



Ergonomic leg release mechanism



Swivel wheels



Side lift handle



Head end extension



Foot-end handle

Product Specifications

| Model | Code | Length | Width | Height Max | Loading Height | Weight | Load Limit |
|-------------------|-----------------|---------|--------|------------|----------------|--------|------------|
| Transporter ST64 | <i>FWE-ST64</i> | 1970 mm | 550 mm | 987 mm | 670-730 mm | 28 kg | 270 kg |
| Transporter ST70 | <i>FWE-ST70</i> | 1970 mm | 550 mm | 1045 mm | 730-790 mm | 28 kg | 270 kg |
| RS-2 Lift-Off Top | <i>FWE-RS2</i> | 1950 mm | 550 mm | 150 mm | - | 23 kg | 230 kg |

Optional Accessories

| 417 Adult Harness | QR PediMate | Baby Capsule Harness | IV Pole | Stretcher Cover | Mattress | Floor Lock |
|---|---|---|---|--|---|---|
|  |  |  |  |  |  |  |
| BRH-417-50 | BRH-678-QR | BRH-419 / BRH-420 | 083-2024 | FWESC | 037-4874 | 0573080 |

Ferno 50-E Ambulance Stretcher Code FWE50-E (undercarriage), FWE155E (top), FWE50QFX-155E (lock interface)

Winner of an Australian Design Award. The Ferno 50-E Ambulance Stretcher was developed in Australia in consultation with ambulance services and ergonomists and offers enhanced ergonomics and manoeuvrability. Carefully designed loading features reduce the physical demand on the operator during the load and unload phase. The operator simply pulls one handle to break the front legs while the rear legs stay locked and take the weight of the stretcher and patient. As the stretcher rolls into the ambulance the front load wheels and additional intermediate wheels continue to take the weight of the patient. The rear legs automatically fold once the rear leg touch bar comes in contact with the ambulance. Throughout the loading sequence only a small proportion of the weight is carried by the operator.

Key features

- Front and rear automatic leg release touch bars provide minimum lift loading
- Intermediate load wheels for a smooth friction-free loading
- On-demand 4 wheel swivel option
- High visibility frame with reflective labelling for better on-scene visibility
- There are 5 adjustable height positions for improved patient transfer
- Tracker electronic cycle counter
- 230 kg safe working load
- Gas-assist backrest with infinite positions
- Multiple shock positions
- Extending carrying handles
- Dynamically crash tested and compliant with AS/NZS 4535:1999



Matress and restraints sold separately



FWE155E Top Only
Matress and restraints sold separately

The 50-E consists of two main parts. The 50-E undercarriage and the 155-E stretcher top. The 155-E stretcher top can be removed and swapped with other 50-E undercarriages to eliminate the need to transfer or man handle a patient. It is supplied with a gas assist backrest, multiple shock position and extending carrying handles.

Product Specifications

| Length | Width | Load Height | Highest Level | Middle Level A | Middle Level B | Lowest Level | Folded | Weight | Load Limit |
|---------|--------|-------------|---------------|----------------|----------------|--------------|--------|--------|------------|
| 1980 mm | 560 mm | 710 mm | 855 mm | 762 mm | 645 mm | 427 mm | 175 mm | 49 kg | 230 kg |

Optional Accessories

| 417 Adult Harness | QR PediMate | Baby Capsule Harness | Equipment Table | Bolstered Mattress | Floor Lock | IV Pole |
|---|---|---|---|--|---|---|
|  |  |  |  |  |  |  |
| BRH-417-50 | BRH-678-QR | BRH-419 / BRH-420 | FWE-2100 | MCM-50 | LA50-FL | LAIV-2030 |

Ferno 26-E Ambulance Stretcher Code FWE26-ELL (low), FWE26-EHL (high)

The Ferno 26-E Ambulance Stretcher is designed in consultation with various ambulance services personnel and ergonomists across Australia, the 26-E stretcher offers improved manoeuvrability, superior stability and load capacity as well as many enhanced loading and handling features requested by end users.

Key features

- Load limit of 275 kg when supported by all 6 carry handles
- Available in low or high leg versions for ambulance fleets of varying heights
- High visibility frame with reflective labelling for better on-scene visibility
- 4 x 150 mm wheels with increased surface area for easy rolling and longer life
- On-demand 4 wheel swivel option
- Pull-out side handles to assist loading heavy patients and easier manoeuvrability on rough terrain
- Longer wheel base for increased stability
- Independently operated, self loading legs for ease of loading
- Bed level function for improved transfer of patients
- Shortening feature for improved manoeuvrability in confined spaces such as lifts and narrow passageways
- Two-stage shock position
- Gas-assist backrest with infinite positions for patient comfort
- Head end extension for taller patients or patients with leg splints
- Tracker electronic cycle counter
- Dynamically crash tested and compliant with AS/NZS 4535:1999



Mattress and restraints sold separately

Product Specifications

| | Length | Length Shortened | Width | Loading Height Range | Height Highest Level | Height Mid Level | Height Low Level | Weight | Load Limit |
|--------------|---------|------------------|--------|----------------------|----------------------|------------------|------------------|--------|------------|
| Low Version | 2060 mm | 1720 mm | 580 mm | 580-650 mm | 770 mm | 440 mm | 200 mm | 46 kg | 275 kg |
| High Version | 2060 mm | 1720 mm | 580 mm | 670-755 mm | 860 mm | 440 mm | 200 mm | 46 kg | 275 kg |

Optional Accessories

| 417 Adult Harness | QR PediMate | Baby Capsule Harness | Stretcher Cover | Bolstered Mattress | Floor Lock | IV Pole |
|-------------------|-------------|----------------------|-----------------|--------------------|------------|-----------|
| | | | | | | |
| BRH-417/26E | BRH-678-QR | BRH-419 / BRH-420 | FWESC | MCM-2650 | LA26-FL | LAIV-2030 |

Ferno 28Z PROFlexx Ambulance Stretcher Code FWE28Z

The new Ferno 28Z PROFlexx Ambulance Stretcher provides maximum versatility for patient transport and is ideal for confined spaces such as tight hallways, narrow staircases, and small elevators, eliminating the need to transfer the patient. The 28Z is lightweight, with superior stability and load capacity. Flexible handling features minimise situations that may cause injury to either the operator or patient.

Key features

- Transition from stretcher to chair provides manoeuvrability in confined spaces
- 120 cm length in chair position
- Lightweight at 31 kg
- Pull-out side handles and optional flip-out foot-end handles
- 4 x 150 mm wheels (2 fixed and 2 swivel with rolling and swivel wheel locks)
- 318 kg load capacity
- Gas-assist backrest with infinite positions
- Wider bed surface with heat sealed mattress
- Reflective labelling for better on-scene visibility



Product Specifications

| Length | Stretcher Height | Chair | Weight | Load Limit |
|--------------------------|-------------------------|-------------------------|----------------|------------|
| 2030 mm (folded) | 230 mm (folded) | 1400 mm (max height) | 31 kg (weight) | 318 kg |
| 1910 mm (raised) | 840 mm (raised) | 640 mm (overall width) | | |
| 1200 mm (chair position) | 660 mm (loading height) | 1220 mm (overall depth) | | |

Service

All equipment needs to be maintained and looked after, no matter how robust and well made they are. Ferno Australia provides a full-featured Service Department that operates nationally to work with our customers including all major ambulance services in Australia.

Operating through a network of Mobile Service Centres and agencies, our knowledgeable team of manufacturer-trained technicians are on hand to perform scheduled maintenance or full repairs and service on a gamut of front-line equipment including ambulance stretchers, stair chairs, scoops, vacuum mattresses, traction splints, floor locks and resuscitation gear plus more.

For convenience, service training can be provided to customers in remote locations. The Service Department is located at our Brisbane head office which allows them to work closely with Ferno Management, Engineering and R&D on new and existing Ferno products.



Ferno Model 30 Stretcher Code FWE30

The Ferno Model 30 is a classic lift in style stretcher. The simple X-frame undercarriage provides multiple height adjustment. It is a low cost alternative to other stretchers on offer.

Key Features

- Lightweight 26 kg
- Six levels of height adjustment
- Foot end lead handle
- Swing-down side rails
- Four swivel wheels and telescoping head-end frame reduces overall length for manoeuvring
- Adjustable backrest
- Includes mattress and two patient restraints

Product Specifications

| Length | Width | Height | Weight | Load Limit |
|--------------|-------|-------------|--------|------------|
| 194 cm (max) | 58 cm | 82 cm (max) | 26 kg | 181 kg |
| 163 cm (min) | | 31 cm (min) | | |



Includes mattress and restraints

Ferno 26T Stretcher Code FWE26T

The Ferno 26T has been the work horse of Australian ambulance services for many years. It is a simple, economical low maintenance stretcher.

Key Features

- Three height positions including load, ground and an intermediate bed or transfer height.
- Adjustable backrest
- Shock position
- Swing down side rails
- Shortening feature
- Foot and head end extending handles
- Compliant with ambulance crash test standards AS/NZS 4535:1999

Product Specifications

| Length | Width | Height | Weight | Load Limit |
|-----------------------------|-------|-----------------------------|--------|------------|
| 244 cm (handles extended) | 55 cm | 81 cm (highest) | 27 kg | 181 kg |
| 201 cm (handles folded) | | 48 cm (intermediate height) | | |
| 172 cm (shortening feature) | | 24 cm (folded height) | | |



Mattress and restraints sold separately

Ferno Model 25 Ambulance Stretcher Code FWE25

The Ferno Model 25 Ambulance Stretcher is a low cost alternative that is both simple and durable in its design.

Key Features

- Independently operated legs for ease of loading
- There are 2 height levels: fully elevated and ground level
- Adjustable backrest angle from 0° to 75°
- Swing down side arms for convenient patient transfer
- There are 2 stationary and 2 swivel wheels

Product Specifications

| Length | Width | Folded Height | Weight | Load Limit |
|--------|-------|---------------|--------|------------|
| 192 cm | 55 cm | 24 cm | 22 kg | 181 kg |



Mattress and restraints sold separately

HARRIER® XL Powered Trolley

The Harrier XL delivers easy-to-use powered lifting that reduces the risk of injury to patients and operators. The Harrier XL uses a unique LBS (Large Body Surface) to create higher levels of dignity and comfort for obese patients. It also incorporates sensor-touch buttons for fast operation, and integrated infection control for added patient and operator safety.

Key features

- Powered ambulance trolley with an even horizontal lift
- Sensor-touch buttons for fast, easy operation with soft stop and start
- Polyurethane moulded cot sidearms provide protection for the patient
- Manual override for trolley lowering in the unlikely event of power loss
- New moulded mattress system with integrated infection control
- Anti-static wheels prevent unwanted static shock
- Directional wheel lock for ease of manoeuvrability
- Raises and lowers while in the lock (lock optional)
- Tracker system to aid maintenance schedule



Includes mattress and restraints

Optional features

- Directional wheel lock for ease of manoeuvrability
- Folding footbar/rest

| Code | Max Height | Min Height | Overall Length | Width Sides Full Extend | Width Standard | Weight | Load Limit | Load Limit Lowest Position |
|------|------------|------------|----------------|-------------------------|----------------|--------|------------|----------------------------|
| TBA | 968 mm | 494 mm | 1920 mm | 961 mm | 561 mm | 82 kg | 350 kg | 400 kg |

Ferno Powerflexx Powered Ambulance Stretcher

Code FWEPF

The Powerflexx Powered Ambulance Stretcher is designed to meet the increased demand for transport management of bariatric patients. The Powerflexx will comfortably lift 318 kg at the touch of a button or transport up to 454 kg in the lowest transport height. The stretcher also features a five stage shortening feature and bed height adjustment from 33 cm to 104 cm. 15 cm wheels, a wide wheel base with low centre of gravity provides great stability over all types of terrain. The capabilities of the Powerflexx can be further extended by accessories such as the Large Body Surface attachment (LBS Jr), In-vehicle Integrated Charging System (ICS), Push Pull Handle Kit plus many more.



Includes mattress and restraints



Operator control pad



24 V battery pack



5 Stage Shortening feature

| Length | Width | Bed Height Range | Max Load Height | Weight | Lifting Capacity | Load Limit | Load Limit Loading Position | Power |
|------------------------------|-------|------------------|-----------------|--------|------------------|------------|-----------------------------|--------|
| 211 cm (max) 155 cm (min) | 61 cm | 33 cm -104 cm | 84 cm | 60 kg | 318 kg | 318 kg | 454 kg | 24 VDC |

Optional Accessories

| Ferno 513 IV Pole | 417 Adult Harness | Bariatric Harness | Large Body Surface Jr | Integrated Charging System | Bariatric Towing Ring | Bariatric Push-Pull Handles |
|---|---|---|---|--|---|---|
|  |  |  |  |  |  |  |
| LAIV-513 | BRH-417-50 | FWE-PFBH | FWEPF LBS Jr | FWEICS | 082-2121 | FWEPF-BPH |

Ferno Large Body Surface Jr (LBS Jr) *Code FWEPF-LBS Jr*

Convert your Ferno Powerflex Stretcher with the Ferno Large Body Surface Jr. (LBS Jr) The unique design increases the width of the Powerflex to 106 cm to accommodate larger patients. The LBS Jr also features folding wings that provide the option to reduce its profile from 106 cm to 74 cm for better manoeuvrability through doorways or tight walkways. The LBS Jr. attaches by a system of pins and mounting blocks and does not interfere with the function of the stretcher. When not in use the LBS Jr. folds flat, ready for deployment. The Ferno Manta Rescue Aid is also provided with each LBS Jr. to assist in moving the patient.

Key Features

- Increases patient surface to 106 cm width or 74 cm with wings raised
- Supports up to 454 kg when at lowest load position
- Includes restraint extenders, mounting blocks and hardware
- Folds easily and flat for storage
- Includes a Ferno Manta Rescue Aid for patient transfer
- Includes patient pillow wedge



Manta Rescue Aid supplied with LBS Jr



Ferno Bariatric Push-Pull Handles *Codes FWEPF-BPH*

The Ferno Bariatric Push-Pull Handles have been designed by Ferno Australia in conjunction with various Australian ambulance services. The handles provide emergency personnel with ergonomically positioned handle(s) that allow head and foot end operators to safely and carefully guide and propel a patient up to 454 kg when being transported in the stretcher's lowest position. Each handle kit is supplied with mount brackets and when fitted do not interfere with the stretcher's operations. The handles can be purchased as a full head and foot end kit or individually. The head end handle kit attaches to the Powerflex stretcher frame while the foot end handle kit attaches to the Ferno LBS Jr.



Ferno 417 Bariatric Harness *Code FWE-PFBH*

Ferno has drawn on its understanding of current ambulance crash standards and knowledge of Australian fall protection standards to produce an extensive bariatric harness that will withstand the excessive G forces should a bariatric patient be involved in an accident during transportation. The harness is constructed with oversize high strength webbing with adjustable buckles and attaches to both the standard stretcher harness mount points as well as six pre-positioned, floor mounted tie down points via 50 kN steel karabiners. The 417 Bariatric Harness is compatible with the Ferno Powerflex stretcher fitted with the Ferno LBS Jr.

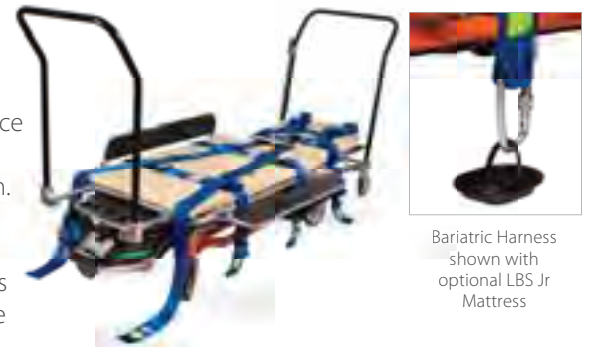

Bariatric Harness shown with optional LBS Jr Mattress



Ferno 417 Adult Harness Code BRH-417

Developed in conjunction with various Australian ambulance services, the multi-functional two-piece design allow users to fit or remove the harness to the patient while on the stretcher. The design also allows the harness to be fitted under or over existing linen, allowing for easier, uninterrupted transfer of patients. The Ferno 417 Adult Harness is part of a complete suite of approved and compliant harness systems that provides restraint for newborns to obese adults.

The Ferno 417 Adult Harness has been dynamically crash tested to 20 G forward and 10 G sideward and is compliant with ambulance crash test standards AS/NZS 4535:1999.*



Ferno QR Pedi Mate Code BRH-678-QR

The Ferno QR Pedi Mate is an innovative, fully adjustable, seven point harness and restraint system that provides the ideal solution for the safe control of paediatrics during ambulance transportation. The Ferno QR Pedi Mate can be used with the backrest inclined or supine. An illustrated patient pad and simple quick release buckles allow for efficient fitting and removal from stretcher. The patient restraints and buckles are smaller and low profile and provide a safe, logical and non intrusive fit to paediatrics. The Ferno QR Pedi Mate rolls to a compact size, allowing for ease of storage and quick retrieval and is suitable for paediatrics between 3.2 kg and 18 kg. The Ferno QR Pedi Mate Harness is part of a complete suite of approved and compliant harness systems that provides restraint for newborns to obese adults. It has been dynamically crash tested with a 9 kg and 18 kg crash dummy to 20 G forward and 10 G sideward as per ambulance crash test standards AS/NZS 4535:1999.*



Ferno Baby Capsule/Convertible Chair Harness

Codes BRH-419 (Baby Capsule Harness), BRH-420 (Convertible Chair Harness)

Ferno Baby Capsule and Convertible Chair Harnesses have been developed as an interface between various Ferno stretchers and Australian style baby capsules and convertible chair/capsules and form part of the complete suite of approved and compliant harness systems that provides restraint for newborns to obese adults. The harnesses have been dynamically crash tested to 20 G forward and 10 G sideward and are compliant with ambulance crash test standards AS/NZS 4535:1999.*

* Can only be fitted and used in conjunction with stretchers that have been fitted with the Ferno Harness Mount Kit Model 417/MKIT.



Ferno Patient Restraints

Ferno offers a complete range of restraints with various colour and length options. These include:

- | | |
|--------------|--|
| BRR-TRAVREST | Two-piece five foot double bar buckle |
| BRR-43017 | One-piece seven foot metal buckle |
| BRR-43017P | One-piece seven foot plastic buckle |
| BRR-43025 | Two-piece five foot metal buckle |
| BRR-43025SC | Two-piece five foot metal buckle with speed clip connectors |
| BRR-43025P | Two-piece five foot plastic buckle |
| BRR-43025PSC | Two-piece five foot plastic buckle with speed clip connectors |
| BRR-43027 | Two-piece seven foot metal buckle |
| BRR-430VSC | Velcro one-piece restraint, variable in length, with speed clip connectors |



Ferno 414-OL Wrist Restraints *Code BRR-414OL*

The Ferno 414-OL Wrist Restraints are conveniently adjustable and fastened to both sides of the stretcher or backboard to secure the patient's wrists.



Ferno 414-R Sidearm Wrist Restraints *Code BRR-414R*

Ferno's 414-R Sidearm Wrist Restraints securely hold a patient's wrists to the top of the stretcher's side rails. These restraints utilise velcro closures and are available in a set of two.



Ferno 415 Ankle Restraints *Code BRR-415*

Ferno 415 Ankle Restraints hold a patient's ankles securely in place to both sides of the mainframe. These restraints conveniently allow each leg to be individually secured and released.

Universal Psychiatric Restraint Set *Code BRH-MPRB*

The Universal Psychiatric Restraint Set is designed for use on a variety of stretchers or beds. It features two single wrist cuffs and a double ankle cuff strapping system. Each cuff features a padded, double overlap, strap system secured with velcro and is adjustable to a variety of limb sizes. An adjustable tie down loop provides some flexibility in attachment points. Each strap is fitted with a quick connect, double action, industrial rated buckle. Machine washable.



Ferno Floor Locks *Code LA26-FL and LA50-FL*

Made from die-cast stainless steel the Ferno Floor Lock provides unrivalled strength, yet is simple in design and use. The stretcher floor lock hooks are designed to fully capture the front and rear attachment points of the stretcher with one simple pull of the floor lock lever. When fitted correctly the Ferno Floor Lock combined with an approved Ferno harness restraint will provide the user with a complete AS/NZS 4535:1999 system that safely and securely restrains a patient to the stretcher and the stretcher to the ambulance. Ferno Floor Locks have been dynamically crash tested to 20 G forward and 10 G sideward and are compliant with ambulance crash test standard AS/NZS 4535:1999

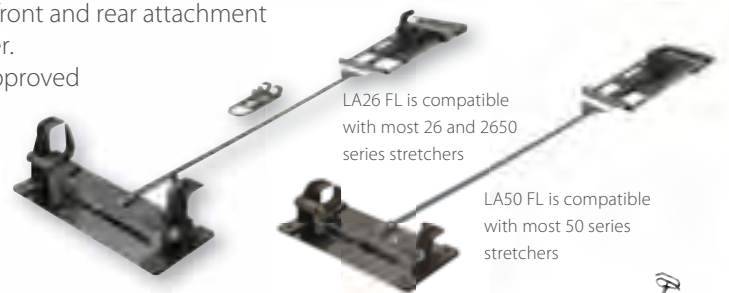

Ferno 2030 IV Pole *Code LAIV-2030*

The Ferno 2030 IV Pole is a lightweight permanently attached IV pole that conveniently fits within the side rail of most Ferno stretchers. For after-market installation, each Ferno 2030 IV Pole comes complete with a new side rail for quick and easy fitting. Includes bracket mount for IV accessories and hooks for two IV bags. The IV pole is for mounting on the (patient) left hand side of stretcher only.



Ferno 513 IV Poles *Code LAIV-513-10 (swing down) and LAIV-513-13 (removable pole)*

Permanently mounted base with either a removable or swing down pole. Maximum load 2 kg fully extended and 23 kg at retracted length. Suitable for most Ferno stretchers.

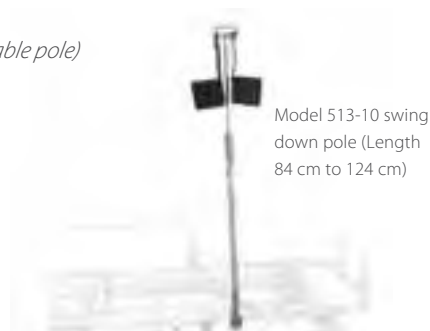

Ferno 274 Pac Rac Stretcher Table *Code LA50-274/1 and LA26-274*

The Ferno 274 Pac Rac Stretcher Table is designed to securely hold essential emergency equipment during patient transport. Quick clip mounting allows the table to be attached directly to the rails of a stretcher. The Ferno 274 is lightweight and folds for portability and storage. There are two versions that allow compatibility with most Ferno stretchers. The LA 50-274/1 is compatible with most 50 series stretchers, whilst the LA26-274 is compatible with most 26 and 2650 series stretchers.



| Length | Width | Height | Weight | Load Limit |
|---|-------|--------|--------|------------|
| 54 cm (table surface) 57 cm (overall length) | 34 cm | 37 cm | 3.8 kg | 34 kg |

Ferno Equipment Table *Code FWE-2100*

The Ferno Equipment Table is designed to securely hold essential emergency equipment during patient transport. Tube clamps allow the table to be attached directly to the rails of a stretcher and a side opening gate allows patient transfer without the need to remove the table from the cot. Two integral IV poles with securing velcro straps provide safe and secure transport of up to four IV bags. The Ferno Equipment Table has been dynamically tested with 29 kg to 20G in forward and sideward directions making it the choice of equipment tables for both aeromedical and road ambulance use. It is lightweight and folds for portability and storage and suitable for use on the 155 series litter tops.



Product Specifications

| | Length | Width | Depth | Weight | SWL |
|---------------------|---------|---------|--------|--------|---------|
| Tray Surface | 52.5 cm | 36.5 cm | 38 cm* | | |
| Folded | 60 cm | 60 cm | 12 cm | 5 kg | 29 kg** |

* 38 cm from stretcher frame ** SWL = 25 kg on tray plus 2 x 1 litre IV bags per extended IV pole.

Ferno Eclipse Torch Holder *Code LA-2080*

The Ferno Eclipse Torch Holder allows a small torch to be placed virtually anywhere on a stretcher for hands free illumination of the immediate area. By adjusting the integral stretch cord it allows manipulation of the torch so that it can be positioned at various angles allowing for perfect adjustment and illumination.



Ferno 2020 Equipment Bracket *Code FWE2020*

The Ferno 2020 Equipment Bracket is compatible with most Ferno stretchers. It allows for convenient storage of gear while the stretcher is not in an ambulance. The bracket is spring loaded which allows it to automatically retract within the stretcher frame when not in use.



Ferno Bolstered Mattress *Code MCM-2650 (26 Series mattress) and MCM-50 (50 Series mattress)*

Ferno has designed a bolstered mattress to suit the harsh environment and road conditions experienced in Australia. Our mattress combines four layers of foam with varying densities and shapes to provide the ultimate comfort for patients. Slow recovery foam with bolstered sides creates a centring action that stabilises patients, providing support in transit. Each mattress is covered in soft, flexible, medical grade vinyl on the patient area with durable, hard wearing, medical grade vinyl on the underside to prevent mattress damage. Each mattress is heat sealed to prevent ingress of fluids.



Ferno Patient Shield

The Ferno Patient Shield is specially designed to minimise the transfer of pathogens between patients and patient handlers, equipment and the environment. Designed for use with most Ferno Stretchers the Patient Shield attaches to the stretcher backrest frame and does not interfere with IV poles or oxygen delivery. Supplemental oxygen is required to prevent carbon dioxide build-up.



Ferno Patient/Stretcher Cover *Code FWESC*

The Ferno Patient/Stretcher Cover protects bedding, equipment and will keep patients dry in inclement weather. It is made from lightweight, coated nylon and the cover contains a dual zip that opens from both ends to access patient or equipment. The cover can be rolled or folded and stuffed into its self contained storage pouch which can be attached to the stretcher with the integral Velcro attachment straps. The Ferno Patient/Stretcher Cover has a full length, elasticised rim and outer Velcro straps that allows it to be fitted to any cot or basket stretcher or patient. Supplied in Lime Green.

Supplied in Lime Green,
no reflective



Ferno Model 9 Emergency Stretcher with Wheels

Code FWE9

The Ferno Model 9 Emergency Stretcher is a simple, low profile stretcher featuring an adjustable backrest, telescoping head end frame for manoeuvring in tight spaces and a centre hinge to fold for compact storage. The 100 mm load wheels, low profile and light weight design serves well in vehicles where headroom is limited. The Model 9 is made with lightweight aluminium with a heavy-duty, vinyl-coated nylon cover. An Aviation model is also available with FAA approved cover and two model PR-STFL FAA approved black patient restraints. Can be used with Model 385-A Storage/Carrying Case.

The Ferno 9 Aviation Stretcher has been installed and certified in many aircraft around the world, It is not supplied with a certificate of approval for aircraft application. This is the responsibility of the customer in conjunction with an engineer due to issues such as the aircraft structure, fastener or retention system and patient restraint system.



Product Specifications

| Open Length | Folded Length | Width | Height | Weight | Load Limit |
|-------------|---------------|-------|--------|--------|------------|
| 187 cm | 94 cm | 47 cm | 16 cm | 8 kg | 159 Kg |

Ferno 1400 Series Aviation Stretcher

Code FWE1401, FWE1402 and FWE1403

The Ferno 1400 Series Aviation Stretcher is a popular option for many different types of aircraft because of its accommodating option package. Available in a non-folding, bi-folding or tri-folding base, each base offers options and accessories including square or tapered foot and head ends, location or locking pins, rollers, trackball, non-rolling or flat bottom. Standard features include backrest and two lock down studs.



The Ferno 1400 Aviation Stretchers have been installed and certified in many aircraft around the world, It is not supplied with a certificate of approval for aircraft application. This is the responsibility of the customer in conjunction with an engineer due to issues such as the aircraft structure, fastener or retention system and patient restraint system.

Ferno 11 Folding Emergency Stretcher

Code FWM11

The Ferno 11 Folding Emergency Stretcher is a simple, fold away, flat stretcher featuring folding head end 10 cm wheels and folding foot end posts. The centre hinges and folding head end wheels and foot end posts enable the stretcher to fold for compact storage. The stretcher comes with a load capacity of 159 kg and can be used with the Model 385-A carry case. Supplied standard with two patient restraints.

Product Specifications

| Open Length | Folded Length | Width | Height | Weight | Load Limit |
|-------------|---------------|-------|--------|--------|------------|
| 187 cm | 94 cm | 47 cm | 21 cm | 7 Kg | 159 Kg |



Ferno 11-T Stretcher

Code FWM11-T

The Ferno 11-T Stretcher is sturdy and lightweight with an innovative track system that allows ease and more control when retrieving patients down stairs. It has two front wheels and narrow track-to-ground clearance for easy manoeuvring over all surfaces, even with tracks deployed. Folds in half when not in use for carrying and storage. Includes two metal buckle patient restraints, a footrest and a carry case.

Product Specifications

| Open Length | Folded Length | Width | Height | Weight | Load Limit |
|-------------|---------------|-------|--------|--------|------------|
| 193 cm | 93 cm | 50 cm | 20 cm | 11 Kg | 159 Kg |



Patient Handling

Immobilisation

Trauma / Airway Kits

Airway / Oxygen

Defibrillation / Diagnostic

BLS / ALS Packs & Cases

Vehicle Management

Casualty Room

Ferno Emergency Pole Stretcher Code FWE108AF (dual fold) and FWE108A (single fold)

The Ferno Emergency Pole Stretchers 108A and 108AF are lightweight, high-strength emergency stretchers suitable for first aid response, industrial sites and casualty rooms. They are made with PVC coated nylon covers that are heat sealed making them resistant to blood, body fluids and mildew and easy to clean. All Ferno Emergency Pole Stretchers feature lightweight aluminium poles with contoured, flexible hand grips for easy handling. Both stretchers fold however 108AF also hinges at the centre permitting the stretcher to dual fold for compact storage. Available in standard emergency orange with optional wall mounted carry cases. Accessories include carry case for the 108AF model MCC-383B and MCC-384C for the 108A.



Product Specifications

| Length | Width | Height | Weight | Load Limit |
|--------|-------|--------|--------|------------|
| 231 cm | 55 cm | 14 cm | 6 kg | 159 kg |

Saver Foldable Bed Code FWES2033

The Saver Foldable Bed has been designed to help you provide a fast, effective, and economical response to mass casualty and hospital surge situations. It supports up to 159 kg and folds for easy storage and transport, and it sets up in seconds. Supplied with two IV pole holders.



Product Specifications

| Length | Width | Height | Unit Weight | Load Rating |
|--------|-------|--------|-------------|-------------|
| 195 cm | 80 cm | 45 cm | 10 kg | 159 kg |

Saver Stacking Catastrophe Stretcher Code FWES2032

The Saver Stacking Catastrophe Stretcher is the ideal product for mass casualty and catastrophic situations. The Saver Stacking Catastrophe Stretcher conveniently stacks onto itself for compact storage and quickly deploys to accommodate multiple victim scenarios. It is constructed of durable, lightweight aluminium, and heavy-duty vinyl coated nylon that is fire retardant and stain resistant.



Product Specifications

| Length | Width | Height | Unit Weight | Load Rating |
|--------|-------|--------|-------------|-------------|
| 187 cm | 48 cm | 18 cm | 3 kg | 159 kg |



Ferno Compact Carry Chairs

The Ferno Compact Carry Chairs are simple, effective and lightweight for use in the ambulance and pre-hospital environments. They fold to a compact size for convenient handling and in vehicle storage. A tall back section offers support across the patient's shoulders and a large foot area is also provided for patient comfort. Moulded foot and head-end hand grips enhance comfort and stability for the attendant. Each model is supplied standard with chest and ankle restraints. Available in two widths, the most narrow (38 cm) is suitable for narrow aisle evacuation such as aircraft, bus and trains. An optional storage/carry case is available. Restraint options. 2040 supplied with 1 x 50 mm plastic buckle chest restraint and 1 x 25 mm plastic buckle ankle restraint. 2041 supplied with 2 x 100 mm velcro chest and thigh restraint and 1 x 25 mm plastic buckle ankle restraint. The 2042 is supplied with 2 x 50 mm metal buckle restraints.



Product Specifications

| Description | Length Open | Length Folded | Width | Height Open | Height Folded | Weight | Load Limit |
|-------------|-------------|---------------|-------|-------------|---------------|--------|------------|
| Model 2040 | 126 cm | 81 cm | 40 cm | 91 cm | 20cm | 11 kg | 160 kg |
| Model 2041 | 126 cm | 81 cm | 38 cm | 91 cm | 20 cm | 12 kg | 160 kg |
| Model 2042 | 126 cm | 81 cm | 40 cm | 91 cm | 20 cm | 12 kg | 160 kg |

Ferno Evac-U-Seat

The Ferno Evac-U-Seat is ideal for the emergency evacuation of patients or for moving a patient from a seated position to a bed or stretcher. It is constructed of tough reinforced nylon that is machine washable. Four handles assist in moving the patient short distances and a simple patient leg/waist strap provides patient security. The Evac-U-Seat can remain underneath the stretcher mattress or be attached to the stretcher frame in the supplied carry case. Rated to 152 kg.



Ferno EZ Glide with PowerTraxx Stair Chair Code FWE59-TP

The Ferno EZ Glide with PowerTraxx is designed to climb or descend stairs with a push of a button, no more carrying or lifting is required. The EZ-Glide with Powertraxx provides maximum safety when going up and down stairs using an electronically controlled motor and direct drive transmission with chair tracks. The tracks and motor carry the patient load, not the operator. Enjoy maximum performance on every call with intelligent power system that runs up to 20 flights of stairs per charge. The chair's easy operation when climbing or descending stairs with intuitive, easy-to-use paddle-style controls keep you in control. The EZ Glide offers multiple accessories such as padded headrest, rear lift handles, IV Pole and various storage brackets. The EZ Glide is also still available with the standard track system (Model 59T) and for those who already own the original Ferno EZ Glide a retro-fit kit is available.



EZ Glide PowerTraxx



Paddle Style Control

Product Specifications

| Weight | Load Limit | Folded Height | Folded Width | Folded Depth |
|--------|------------|---------------|--------------|--------------|
| 26 kg | 227 kg | 95 cm | 52 cm | 20 cm |

Options and Accessories

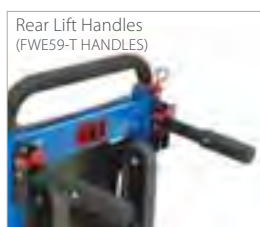

Rear Lift Handles
(FWE59-T HANDLES)

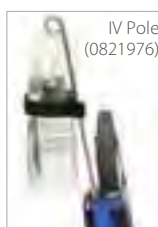

IV Pole
(0821976)



Milwaukee Battery and
Charger



Head Rest



Storage Bracket
(0822073)



Secure Lock 20g (0822071)

Ferno EZ Glide Evacuation Chair Code FWE59-T

The EZ Glide Evacuation Stair Chair glides patient loads up to 227 kg down stairs without carrying or lifting. Large 150 mm wheels and 100 mm front swivel-wheels provide superior maneuverability over carpet and in confined spaces such as stairwells and landings. The large seat area is supplied in snap-on ABS plastic panels. Five position lift bar and handles reduce the strain of lifting and provide maximum control for operators of various heights. The EZ Glide™ Evacuation Chair offers multiple accessories such as padded headrest, rear lift handles, IV Pole and various storage brackets. The EZ Glide can also be upgraded with the PowerTraxx Retrofit Kit.

Shown with optional rear lift handles



Product Specifications

| Weight | Load Limit | Folded Height | Folded Width | Folded Depth |
|--------|------------|---------------|--------------|--------------|
| 15 kg | 227 kg | 95 cm | 52 cm | 18 cm |

PowerTraxx Retrofit Kit 240VAC Code 083-2196



The PowerTraxx Retrofit Kit turns your existing manual EZ Glide into a power stair chair. Now you can glide up to 227 kg up and down stairs with ease. The Retrofit Kit is for use with Ferno EZ Glide Evacuation Chairs only and contains one battery, one charger, and the PowerTraxx unit.



Ferno EZ Glide Bariatric Stair Chair

The EZ Glide LBS features all of benefits of the tried and tested EZ Glide tracked chair with an extended seat and strengthened chair frame. This ensures that patients up to 318kg can be safely moved over a variety of surfaces, through confined areas and down stairways, all without risking injury to operators through strain and lifting. The EZ Glide LBS is stronger and wider, incorporating extended sides, reinforced footplate and a strengthened frame, to seat patients with a greater physical mass. Optional seat cushion, headpad and back support accessories also available.

Product Specifications

| Weight | Load Limit | Height | Depth | Width |
|--------|------------|--------|-------|-------|
| 29 kg | 318 kg | 95 cm | 85 cm | 60 cm |



Shown with optional accessories

Ferno EZ-Glide Headrest Code FWE2110



The EZ-Glide Headrest secures firmly into place between the rear lift bars and can be easily adjusted to suit the patient's height by sliding to the appropriate position. A simple head restraint strap is also supplied. Folds to a compact size for storage in a handy carry case that can be stored at the back of chair.

Ferno Transfer Board Code FWESPS

The Ferno Transfer Board has a smooth top and bottom surface which allows for easy, low friction gliding, facilitating patient transfers. Comfort, convenience and adaptability are built into this transfer board. Manufactured from high impact polyurethane it features six grab slots with rounded, smooth edges for operator ease. The Ferno Transfer Board is latex-free.



Product Specifications

| Length | Width | Depth | Weight |
|--------|-------|--------|--------|
| 125 cm | 46 cm | 0.5 cm | 2.3 kg |

Ferno 341 Carry Sheet Code FWE341

The Ferno 341 Carry Sheet is widely accepted as a vital aid in the rapid evacuation of non-ambulance patients from hazardous situations. Suitable for use with medical, surgical, psychiatric and geriatric patients, it is instantly available in emergency situations. Constructed of heavy-duty rip-stop PVC, the Ferno 341 Carry Sheet is easily cleaned and reusable.



Product Specifications

| Length | Width | SWL |
|--------|--------|--------|
| 68 cm | 175 cm | 159 kg |

Ferno Manta Rescue Transfer Sheet Code FWEMRA (orange) FWEMRA-DO (drab olive)

The Manta Rescue Transfer Sheet meets many rescue transfer needs. It can be used to transfer and evacuate patients up to 363 kg and is also ideal for rescues in confined areas. Pockets at both ends will hold a backboard, patient's feet and head and has drain holes for possible water disbursement. Fire retardant. Available in Orange, Maroon or Drab Olive.



Product Specifications

| Length | Width | Weight | Load Limit |
|--------|--------|--------|------------|
| 222 cm | 115 cm | 2 kg | 363 kg |

Ferno Walk Belt Code FWE-WB-LS

The Ferno Walk Belt has been purpose designed for paramedics and emergency healthcare professionals to assist patients while walking. The Ferno Walk Belt secures around a patient's waist and is fitted with eight handles, four horizontal and four vertical handles as well as 2 leg straps that substantially reduces the effort required to assist a patient whilst walking. The Ferno Walk Belt can be machine washed and reused repeatedly.



Ferno CPR Board Code FWECPRB

The Ferno CPR Board is ideal for CPR training and CPR administration by providing a firm surface that helps to properly position a patient to ensure a constant, open airway. The head cup maintains proper alignment of a patient's head, whilst the contoured sides make lifting the patient easier.

Product Specifications

| Length | Width | Weight |
|--------|-------|--------|
| 59 cm | 44 cm | 2 kg |



Ferno 4000 Ultra Care Lift

The Ferno 4000 Ultra Care Lift is easy to manoeuvre and requires minimal effort from only one person to lift and carry patients. Simply press a button on the hand-held pendant and the lift gently raises or lowers loads up to 340 kg. The control unit has an integrated rechargeable battery that can be charged by plugging the lift into a standard wall outlet. The 4000 disassembles for convenient transportation and storage.

Key Features

- Independently operated legs for ease of loading
- Powerful Actuator
- Pendant Control
- Folding Base
- Wheel Locks
- 4 Quick-Connect Slings

Product Specifications

| Code | Boom Height Max | Boom Height Min | Base Length | Base Width | Load Limit | Weight |
|---------|--------------------|--------------------|-------------|------------|------------|--------|
| FWM4000 | 196 cm | 127 cm | 110 cm | 100 cm | 340 kg | 76 kg |



Med Sled Evacuation

Be disaster prepared. When timing is critical, Med Sled Evacuation enables employees to safely transport and evacuate patients from a single or multilevel building. The stairwell braking system and integral patient support provides control of descent with patients two to three times their own weight. No lifting is required when using the roll and drag method. Each Sled has eight handles for lifting, three securing cross straps and a tether and stairwell braking system. The Med Sled Evacuation rolls up and fits into the supplied compact bag with shoulder strap. Toddler and Infant padded inserts to fit within the MS36 or MS48 also available. Wall unit storage devices available for sleds and inserts.

Product Specifications

| Description | Code | Dimensions |
|-------------|---------|-----------------|
| Youth | MS-MS28 | 71 cm x 165 cm |
| Standard | MS-MS36 | 91 cm x 221 cm |
| Bariatric | MS-MS48 | 122 cm x 221 cm |



Stairwell braking system



Wall Unit Storage Options



Optional infant padded insert



Optional toddler padded insert

Baby Pod II Code BP-EV03-STD

Baby Pod II provides a thermo-stable environment and is designed to safely transport patients up to 9 kg. The Baby Pod II consists of a lightweight carbon fibre outer shell lined with a shock absorbent foam inner layer. The unique metal free construction ensures that it is X-ray translucent and MRI compatible. The Baby Pod II has a transparent lid for viewing the baby and also allows for the addition of improved O2 environment, external ventilation. An Apparatus U Bar allows direct attachment of syringe pumps. Other standard features include stretcher fixing straps, infant patient straps, patient positioning vacuum mattress, Tubing Holder and Protective Storage Bag. Accessories for the Baby Pod II include the single use TransWarmer Infant Transport Mattress, a non electric patented WarmGel technology which provides even, regulated heating for up to 2 hours while assisting with vibration absorption during transport. Baby Pod II has been crash tested to 20 g for up, side and forward directions making it suitable for transport in a ground vehicle, helicopter or a fixed wing aircraft. Complies with AS/NZS 4535:1999. Accessories for the Baby Pod II include the single use TransWarmer Infant Transport Mattress (code NEON03) a non electric patented WarmGel technology which provides even, regulated heating for up to 2 hours while assisting with vibration absorption during transport.



| Length | Width | Height | Weight | Weight Limit |
|--------|-------|--------|--------|--------------|
| 100cm | 43 cm | 30 cm | 9,5 kg | 2-9 kg |

Medkids Baby Board Code BRH-676

The Medkids Baby Board helps maintain cervical neutral alignment in infants with the self-contained Pneumatic Positioning Device (PPD). It accommodates the wide range of thoracic elevation requirements without any extra padding. Features a palm style pump with an air release valve for precise inflation and deflation, and offers versatile strap configurations with its adjustable three-point harness system. Made of durable Dupont Cordura and is X-ray translucent.

Key Features

- Compatible with Ferno stretchers and isolettes
- Crescent shaped head blocks secure cervical spines for infants too small for standard size cervical collars
- Accommodates all central lines, umbilical lines, chest tubes, urinary catheters and other invasive and non-invasive equipment
- Designed for preterm neonates and larger infants ranging from 1 kg to 7 kg



Medkids Paediatric Backboard Sleeve Code BRH-677

The Medkids Paediatric Backboard Sleeve fits over standard adult backboards and functions in a similar way to the Medkids Baby Board to help maintain cervical neutral alignment with larger infants from 5 kg to 27 kgs. It accommodates the wide range of thoracic elevation requirements without any extra padding and features a palm style pump with an air release valve for precise inflation and deflation. The sleeve has a versatile patient strap configuration with an adjustable three-point harness system. The backboard sleeve is X-ray translucent and made of durable Cordura.



Key Features

- Adjustable to fit over standard adult backboards
- Rolls into a small, self-contained carrying case for storage
- Crescent-shaped compressible head blocks allow access and visual monitoring of the ears while maintaining immobilisation
- Designed for infants and children ranging from 5 kg to 27 kg



Saver Scoop Stretcher Codes BSSS-265 (with three restraints)

The Saver Scoop Stretcher is designed so emergency personnel can uncouple either or both ends of the stretcher and gently scoop up the patient using a scissor-type closing motion. This scoop stretcher is ideal for hip and spinal injuries and supports the patient in the position found, reducing risk of further injury.

Key Features

- Twin aluminium safety locks provide smooth, non-binding locking and unlocking
- Telescoping tubes allow length adjustments for various patient heights
- Narrow foot end frame for handling in confined areas
- Open-centre design permits patient to be X-rayed
- Folds compact for storage
- Can be used with Model 385-C Storage/Carrying Case



Twin safety locks

Product Specifications

| Length Folded | Length (open) | Length (max) | Width | Height | Weight | Load Limit |
|---------------|---------------|--------------|-------|--------|--------|------------|
| 120 cm | 166 cm | 201 cm | 43 cm | 7 cm | 9.7 kg | 159 kg |

Ferno EXL Scoop Stretcher

Codes BSSF-EXL (3 restraints) BSSF-EXLP (with pins - no restraints) BSSF-EXLG (grey 3 restraints)

The Ferno EXL Scoop Stretcher provides superior comfort and safety to patients who need spinal immobilisation. The EXL supports the patients in the position found and eliminates the need for log-rolls, reducing the risk of further injury.

Key Features

- Made from lightweight, high-impact composite materials
- Thermally-treated polymer construction does not get too hot or cold
- Recessed head section to assist with appropriate cervical alignment
- Narrow foot end for use in confined space immobilisation
- Oval profile and angled handles provide ergonomic ease of use
- Four adjustable lengths accommodate patients of different heights
- Folds compact for storage (optional 385-C Case)
- X-ray transparent



| Length Folded | Length (min) | Length (max) | Width | Height | Weight | Load Limit |
|---------------|--------------|--------------|-------|--------|--------|------------|
| 118 cm | 165 cm | 202 cm | 43 cm | 7 cm | 8 kg | 159 kg |

Mantis Tri-Fold Evacuation Board FWE-MTF

The Mantis Tri-Fold Evacuation Board represents the ultimate in simplicity and durability. It is ideal for vehicle extraction because of its compact size and rapid employment. It is made of light weight aluminum and has zero risk of the fire hazards, cracking, warping and gouging that's common with plastic and composite boards in tactical and vehicle operations. The Mantis has generous hand holds and accepts all common restraint systems.

Key Features

- Deploys in seconds
- 227 kg load rating
- Optional backpack carrier

Product Specifications

| Length (open) | Length (folded) | Width | Weight | Load Limit |
|---------------|-----------------|-------|--------|------------|
| 183 cm | 63.5 cm | 41 cm | 5.8 kg | 227 kg |



Najo Lite *Codes BSBN-L (standard) and BSBN-LP (with pins)*

The Najo Lite is our lightest and most popular Najo backboard at just 6.5 kg. It features a central slot in the lower half of the board to allow immobilisation of each leg separately.

The Najo Lite also features two handholds at the tapered end and angled edges for easy log-rolling. Strong, one-piece HDPE construction is impervious to all body fluids. It is easy to decontaminate and provides 100% X-ray translucency. This board is also buoyant and can be used to float a patient during water rescue operations. Available with optional speed clip pins.

Product Specifications

| Length | Width | Height | Weight | Load Limit |
|--------|-------|--------|--------|------------|
| 183 cm | 41 cm | 4 cm | 6.5 kg | 204 kg |



Najo RediHold *Code BSBN-RH*

The Najo RediHold is our top of the line backboard with two handles at a tapered end for stable transport. The head area is smooth to insure all head immobilisation devices adhere to the board and the edges are angled for log-rolling. Strong, lightweight, one-piece HDPE construction is impervious to all bodily fluids, is easy to decontaminate, and provides 100% X-ray translucency. This board is also buoyant and can be used to float a patient during water rescue operations. Guaranteed for life under normal usage. Available with optional speed clip pins.

Product Specifications

| Length | Width | Height | Weight | Load Limit |
|--------|-------|--------|--------|------------|
| 183 cm | 41 cm | 4 cm | 7 kg | 272 kg |



Najo Mega *Codes BSBN-M (standard) and BSBN-MP (with pins)*

The NAJO Mega Board is specially designed for the larger patients. It has a 454 kg load capacity with a 51 cm width and 203 cm length to allow appropriate restraint or immobilisation. Strong, one-piece HDPE construction is impervious to all bodily fluids, is easy to decontaminate, and provides 100% x-ray translucency. Guaranteed for life under normal usage. This board is also buoyant and can be used to float a patient during water rescue operations. Available with optional speed clip pins.

Product Specifications

| Length | Width | Height | Weight | Load Limit |
|--------|-------|--------|--------|------------|
| 201 cm | 51 cm | 6 cm | 12 kg | 454 kg |



NAJO Water Rescue *Code BSBN-W*

The NAJO Water Rescue Backboard is lightweight and buoyant and especially designed for all water (or land) rescue. The board's tapered foot end is without foam fill allowing easier submersion under patient during water rescue. Strategically placed and designed hand holds provide rescuers additional handling points during water retrieval. Strong, lightweight, one-piece HDPE construction is impervious to all bodily fluids, is easy to decontaminate, and provides 100% x-ray translucency. Guaranteed for life under normal usage.

Product Specifications

| Length | Width | Height | Weight | Load Limit |
|--------|-------|--------|--------|------------|
| 183 cm | 41 cm | 6 cm | 6.3 kg | 204 kg |



Ferno 889P Fibreglass Backboard

Code BSBF-889P (with 3 velcro restraints), BSBF-889P/B (no restraints)

The Ferno 889P is an advanced composite board constructed using Resin Transfer Moulding to provide a strong rigid surface with smooth durable finish. The angled sides allow easy hand hold access while the 14 oversized handles with curved edge provide a comfortable grip with no hot spots. For appropriate restraint and immobilisation 20 restraint speed clips pins is available providing optimum placement of restraints. Two handholds at the foot and head end provide additional handling options. In addition to the 14 handholds the 889P is crafted with four shoulder harness access holes to facilitate ambulance stretcher harness application to the patient and board. The 889P has a unique symmetrical design that simplifies use and wedged design ends for confined space and vehicle extrication.

Product Specifications

| Length | Width | Weight | Load Limit |
|--------|-------|--------|------------|
| 178 cm | 42 cm | 8 kg | 175 kg |



Ferno Faststrap Restraint System

Code BRR-770

The Ferno Faststrap Restraint System is a 10 point, five strap system that is used to secure patients to backboards, scoop stretchers and other devices. Colour-coded webbing, prominent labelling and stiffening within the main skeleton of the restraint allows for rapid, hassle free application in patient immobilisation.



Board, head immobiliser and collar not supplied

Ferno Patient Restraints

Ferno offers a complete range of restraints with various colour and length options. These include:

- BRR-TRAVREST Two-piece five foot double bar buckle
- BRR-43017 One-piece seven foot metal buckle
- BRR-43017P One-piece seven foot plastic buckle
- BRR-43025 Two-piece five foot metal buckle
- BRR-43025SC Two-piece five foot metal buckle with speed clip connectors
- BRR-43025P Two-piece five foot plastic buckle
- BRR-43025PSC Two-piece five foot plastic buckle with speed clip connectors
- BRR-43027 Two-piece seven foot metal buckle
- BRR-430VSC Velcro one-piece restraint, variable in length, with speed clip connectors



Thomas Lift Handle

Codes THOM-THS810

For EMS professionals, most back injuries occur while lifting. The Thomas Handle will attach to any backboard and reduces the amount of bending when lifting a backboard by adding approximately 30 cm to the lifting point, thus lessening back strain, eliminating awkward lifting angles and minimising abrasions on the hands and knuckles. These handles come in a set of four.



Ferno KED (Kendrick Extrication Device) *Code FWE125*

The Original Ferno KED is a versatile means of immobilising and extricating patients from vehicles or confined spaces. The wrap-around vest design provides horizontal and vertical rigidity and immobilisation of the spine, neck, and head during extrication. X-rays or advanced life support procedures can be performed with the KED in place. The Ferno KED includes wrap-around vest, neck roll, two head straps and a carrying case. Heavy-duty, vinyl-coated nylon is durable and easy to clean and the KED stores rolled up, ready for immediate use.



Ferno KED Pro Extrication Device *Code FWE125-2*

The Ferno KED Pro has many industry requested improvements to the original Ferno KED. These improvements enhance patient comfort and user functionality, resulting in better patient outcomes.

Key Features

- Colour-coded webbing
- Improved head/chin straps
- Wide padded spine support section
- Additional deceleration strap for holding shoulders back
- Better head stability and security is achieved via a wider head support piece
- Two additional standing take down manoeuvre straps
- Fold back chest flaps allow access for chest examinations and placement of electrodes
- Padded leg straps with quick connect buckles for confined space rescue operations
- Carry bag with pack away backpack straps and room for storage of neck collars
- Rated rear handles can be used for lifting out of confined spaces using dedicated KED Pro lifting bridle code BRB-KED Pro (available as accessory)



Ferno KED SLED *Code TBA*

The Ferno KED SLED is designed to enable a one-on-one retrieval of a patient in a KED type device by allowing the patient to be easily dragged. The KED SLED is made from durable plastic that protects the patient and the KED, dramatically reducing the effort of moving wounded. The KED SLED enhances the KEDs capability, especially in confined spaces.



Ferno KED Lifting Bridle *Code BRB-KED*

The Ferno KED Lifting Bridle is designed to assist in the vertical extrication of patients with a KED Pro device fitted and acts as an interface between the KED Pro and a rope hoist, cable or other lifting device. The unit consists of three adjustable, colour coded and labelled attachment straps for connection to the lower carry handles and to the top central carry handle.



Ferno XT Code FWE-XT1/2

The Ferno XT is a revolutionary half size backboard designed for rapid extrication and spinal immobilisation in confined space areas and critical situations.

Key Features

- Easy application with four hi-visibility colour coded restraints and buckles
- Lightweight composite fibre board 2 kg
- 100% x-ray translucent
- Comes with QHI Quick Head Immobiliser, head/chin strap, storage pouch
- Dimensions: L 83 cm x W 30 cm



Thomas Backraft Codes THOM-BR (mattress) and THOM-BRP (pump)

The Thomas Backraft is a low-cost, resposable air mattress that provides patient comfort and reduces secondary injury, such as pressure sores, commonly associated with prolonged immobilisation on a hard surface such as a flat spineboard.

The Thomas Backraft inflates in seconds and fills the voids between the patient and backboard but allows for full function of the backboard during extrication and transportation. The Thomas Backraft is X-ray transparent and compatible with spineboard and patient restraint system. Pump sold separately.



Ferno Full Body Vacuum Mattress Codes SVVM-AGB (mattress, pump & case) SVVM-AGB-PUMP (pump only)

Ferno All-In-One Vacuum Mattress provides immobilisation of casualties in cases of suspected vertebra, pelvis or limb trauma. Extracting air from the mattress forces it to become hard and mould around the patient allowing full body immobilisation without pressure points, increasing comfort and reducing the risk of additional trauma. The underside of the Ferno Vacuum Mattress has 12 carry handles and contains three fire-retardant layers for extra protection against punctures. The mattress has a load capacity of up to 220 kg, X-ray translucent and easy to clean. Supplied standard with 4 colour-coded patient restraints, carry bag, repair kit and pump.

Product Specifications

| Length | Width | Height | Weight | Load Limit |
|--------|-------|--------|--------------------------------|------------|
| 205 cm | 80 cm | 7 cm | 9 kg (mattress) 1 kg (pump) | 220 kg |



EasyFix Vacuum Mattress Code SVVM-AGB-EASYFIXVM

EasyFix Vacuum Mattress uses a unique body shape design to optimise the vacuum mattress capabilities and provides a 20% reduction in storage space compared to original vacuum mattress. EasyFix also delivers improved fixation of upper back, neck and head by reinforced base plate that cover all of cervical spine. This together with the cross fixation restraint system provides efficient and effective immobilisation. Carry capacity of 250 kg with 10 integral carry handles. Supplied with mattress, restraints, foot pump, repair kit and bag. Weight: 8,0 kg without fixation straps. 9.6 kg total weight including straps + pump



Ferno Wizloc Collar *Code CCF-WL (pink) CCF-WLG (green)*

The universal design of the Ferno Wizloc Collar provides a collar capable of fitting 90% of patients. With its three-step adjustment, application is simple and fast regardless of patient position. The unique self centring mandible support allows you to custom fit the Ferno Wizloc Collar to the patient. A simple adjustment to the occipital support also accommodates all ends of the sizing spectrum.

Key Features

- Designed for use on a wide range of patients, 2-year-old through to adult
- On-patient sizing for greater accuracy
- Can be decontaminated and reused up to 10 times
- Three position occipital support with keyhole lock pin
- X-ray transparent and MRI compatible



Also available in OD green

Laerdal Stifneck Collar Select *Code CCL-SS*

The Laerdal Stifneck Collar Select fits all adult patients and delivers the same superior immobilisation you would expect from the individual sized Stifneck Collars.

Key Features

- Uses the same sizing and application method as the original Stifneck Collars
- Easy access for pulse checks through oversized trachea hole
- Room for large fingers to slide through rear panel opening for palpation
- Directions moulded into collar
- Radiolucent, MRI and CT scan compatible



Laerdal Stifneck Collar Pedi Select *Code CCL-SSC*

The Laerdal Stifneck Collar Pedi Select fits paediatric patients and uses the same easy sizing application method as used on adults.

Key Features

- Improved sizing to fit a wider range of paediatric patients (mini, midi and pedi)
- Oversized tracheal and back panel opening for advanced airway management and ongoing cervical assessment



Laerdal Stifneck Collar

Codes CCL-SCT (Adult Tall), CCL-SCR (Adult Regular), CCL-SCS (Adult Short), CCL-SCN (Adult No Neck), CCL-SCP (Paediatric), CCL-SCB (Baby No Neck)

The Laerdal Stifneck Collar with outstanding motion restriction and optimal sizing. The Stifneck extrication collar remains the standard of care for suspected cervical spine injuries.

Key Features

- Easy access for pulse check, advanced airway procedures and visualisation through oversized trachea hole
- Radiolucent, MRI and CT scan compatible
- Outstanding motion restriction without hyperextension or limiting access to airway
- Provides optimal size selection with simple, accurate finger-sizing method and colour codes
- Fits entire patient population with four adult sizes and two paediatric sizes



Ferno HeadHugger Head Immobiliser *Code CCI-455*

The Ferno HeadHugger is ideal for remote site immobilisation or for use in mass casualty accidents. The corrugated plastic is durable, water resistant and has a low profile design for storage. Independent support panels fold around the patient's head and can be moulded to fit the patients head contour. Radiolucent, does not interfere with CT scanners or MRIs. Single use.



Ferno Universal Head Immobiliser *Code CCI-445*

The Ferno Universal Head Immobiliser is simple to use, lightweight and easy to clean. Composed of two plastic coated, closed-cell foam head supports, a universal attachment base and two durable head straps. The head supports can be used on standard backboards, or reversed for use on the Ferno EXL or Saver Scoop Stretcher.

Key Features

- Unique head strap is designed to conform to patient's forehead
- Large ear holes for monitoring the patient's ear canal
- Minimal interference with X-ray, MRI or CT scan procedures
- Waterproof plastic coating makes it easy to clean
- Compatible with all flat backboards as well as Ferno Scoop Stretchers



Ferno Head Immobiliser EXL *Code EXL CCI-365E*

The Ferno Head Immobiliser EXL provides all the great features of the Universal Head Immobiliser with a unique shape specifically designed to fit the Ferno Scoop EXL. Unique head strap is designed to conform to patient's forehead. Large ear holes for monitoring the patient's ear canal. Minimal interference with X-ray, MRI or CT scan procedures. Waterproof plastic coating makes it easy to clean.



QHI Quick Head Immobiliser *Code CCI-QHI*

An uncomplicated head immobiliser designed for universal and rapid deployment. Made with low density, polyurethane coated foam that is easy to clean. The shallow V shaped design allows the patient's head to rest on two points providing improved stability. A neoprene head strap with double sided adjustment provides a variety of fixing options. Fully compatible with Ferno Scoop and Ferno Backboards.



Patient Handling

Immobilisation

Trauma / Airway Kits

Airway / Oxygen

Defibrillation / Diagnostic

BLS / ALS Packs & Cases

Vehicle Management

Casualty Room

FernoTrac Traction Splint *Codes SVTS-FA (adult), SVTS-FC (child)*

The FernoTrac Traction Splint has been the standard for ambulance services for treating patients with suspected long bone fractures of the lower extremities. It provides easy to use, dependable traction to relieve pain and reduce the possibility of further vascular and nerve damage. Available in both paediatric and adult versions.



Donway Traction Splint *Codes SVTS-DA (adult), SVTS-DC (child)*

The Donway Traction Splint fits most patients from eight years to an adult of 208 cm. The child splint fits children between four and eight years. This splint provides quantifiable pneumatic powered traction and no lifting of the limb is required. The Donway Splints are compact with a flat profile for easy storage. Supplied with carry bag.



Kendrick Traction Device (KTD) *Code SVTS-KTD*

Cost effective, compact and lightweight, the Kendrick Traction Device (KTD) is ideal for remote area operations and outdoor activities. The traction pole length quickly adjusts for adult or paediatric application, eliminating the need for patient roll-over or unnecessary leg raising. There is no ischial bar, which reduces pressure problems. The KTD comes complete within a very compact storage pouch with easy-to-follow instructions.



Product Specifications

| | Length | Width | Weight |
|---------------|--------|-------|--------|
| Size (stored) | 24 cm | 9 cm | 567 g |

Ferno Vacuum Splint Set *Code SVVS-F*

The Ferno Vacuum Splint Set provides maximum support with minimum effort. Each splint is constructed of durable vinyl coated nylon that is supple enough to be moulded around an injured extremity. Air is extracted via the pump supplied forcing the splint to become hard and mould around the patient providing local immobilisation without inward pressure, reducing the risk of additional trauma. The complete set includes three splints (small, medium and large), compact vacuum pump, repair kit and carry case.



Sager Emergency Traction Splints

Sager splints are anatomically and medically engineered to provide the first responder with a single, fast, easy, fail-safe and compact traction device. Sager provide the world's only emergency traction splints with quantifiable, dynamic traction which ensures the correct amount of safe, secure traction that is able to decrease as the spasm releases. This patented system allows you to accurately document how much traction has been applied. Sager Emergency Traction Splints conveniently stay within the adult body's silhouette making it ideal for emergency transfers and transportation. Sager Splints are indicated for treatment in proximal third and mid-shaft femoral fractures offering a much broader range of application and use than other traction devices.



Sager Bilateral Splint *Code SVTS-S304*

The Sager Bilateral Splint treats either single or bilateral lower limb fractures for both adults and children from 5th to 99th percentile. This splint has an articulating base that hinges to apply counter traction more directly on the ischial tuberosity.



Sager Extreme Splint *Code SVTS-S404*

The Sager Extreme Splint is ideal for extreme environment capabilities. It is compact, robust and lightweight and is easily stored or carried in most backpacks and folds into a 35 cm x 28 cm x 11 cm carry case. The Sager Extreme Splint is radiolucent to all areas of a femoral fracture. It treats single or bilateral lower limb fractures for both adults and children from 5th to 99th percentile. This splint has a multi-patented articulating base and is hinged so that it swings left or right to apply counter traction more directly on the ischial tuberosity in all types of body shapes.



Sager Emergency Fracture Response System (SEFRS) *Code SVTS-S405*

As well as offering quantifiable, dynamic traction to proximal third and mid-shaft femoral fractures the Sager Emergency Fracture Response System (SEFRS) treats any limb fracture in the human body without traction. The SEFRS is compact, durable, robust and lightweight and rapid assembly allows application on fracture in less than 2 minutes.



Sager Infant Bilateral Splint *Code SVTS-S300*

The Sager Infant Bilateral Splint is the only splint in the world that is designed to treat children from birth up to the age of six. The Sager Infant Splint eliminates the risk of over-traction and its detrimental effects to epiphyseal growth centres, knee edema and excessive distraction of bone ends.



Sam Pelvic Sling *Codes SVSP-S (extra small), SVSP-M (standard) and SVSP-L (extra large)*

The SAM Pelvic Sling II is the only force controlled circumferential pelvic belt scientifically proven in peer reviewed studies to safely and effectively reduce and stabilise open-book pelvic ring fractures. It will not over or under tighten providing the, clinically proven, appropriate force to be applied to the patient. The SAM Pelvic Sling II is compact, easy to use and quick to apply. Its durable, radiolucent, MRI safe and can be cleaned for re-use with common detergents or anti-microbial solutions. The standard size fits 98% of the adult population.. Available in military OD green.



Sam Splint Original

The Sam Splint Original is an extremely pliable multi-purpose splint and is built from a thin core of aluminium alloy, sandwiched between two layers of closed cell foam. Bent into various shapes and curves, it becomes extremely strong and supportive for any fractured or injured limb. The Sam Splint Original is also ideal for splinting IV's. Available in a range of sizes, it is lightweight, radiolucent, reusable and very portable. Almost any bone in the body can be splinted with Sam Splint.



Product Specifications

| | Product | Length | Width |
|------------|---------------------|--------|-------|
| SVPS-S36 | Sam Splint 36" | 91 cm | 10 cm |
| SVPS-SG36 | Sam Splint 36" Grey | 91 cm | 10 cm |
| SVPS-S36XL | Sam Splint 36"XL | 91 cm | 14 cm |
| SVPS-S18 | Sam Splint 18" | 46 cm | 10 cm |
| SVPS-S9 | Sam Splint 9" | 23 cm | 10 cm |
| SVPS-SF | Sam Splint Finger | 9.5 cm | 4 cm |



Sam Splint Soft *Codes SVPS-SSS9 (9"), SVPS-SSS12 (12") and SVPS-SSS15 (15")*

Exceptionally comfortable and versatile, strong and malleable like the Sam Original Splint. The Soft Shell Splint is designed for quick and easy application when a patient needs to wear a forearm splint for more than a few hours or even several weeks. The soft aluminium core allows it to be moulded to fit the patient's hand, wrist and forearm. With the proper combination of curves, the Sam Splint Soft can be moulded in seconds into any of four basic shapes shown. The Sam Splint Soft is thicker on one end than on the other, providing two levels of rigidness. Add the comfort of an open-cell foam interior covered in terry cloth and you have the most versatile forearm splint available today. The Sam Splint Soft is available in three sizes.

| | Product | Length | Width |
|------------|---------------------|---------|---------|
| SVPS-SSS9 | Sam Splint Soft 9" | 22.5 cm | 10.5 cm |
| SVPS-SSS12 | Sam Splint Soft 12" | 30 cm | 10.5 cm |
| SVPS-SSS15 | Sam Splint Soft 15" | 38 cm | 10.5 cm |



Thumb spica splint



Ulnar gutter splint



Clamshell splint



Volar splint

Ferno Frac Cardboard Splint *Code SVCB-FF*

The Ferno Frac Cardboard Splint is a low cost, compact and convenient leg splint that can be shaped to fit all leg sizes. The waxed cardboard is water resistant, X-ray transparent and MRI compatible. The Ferno Frac Cardboard Splint folds and locks into position to offer ankle and foot support. Packs flat ready for use. One size can be shaped to suit all.

Product Specifications

| Length | Width |
|--------|-------|
| 99 cm | 33 cm |



Cardboard Splint *Codes SVCB-S (small) and SVCB-L (large)*

The Cardboard Splint is a low-cost, compact and convenient alternative with the capacity to immobilise a broad range of injuries. Available in two sizes.

Product Specifications

| | Length | Width |
|-------|--------|-------|
| Large | 77 cm | 33 cm |
| Small | 41 cm | 25 cm |



Ferno Finger Splint Kit *Codes FWE-FSK*

The Ferno Finger Splint Kit contains a variety of the most commonly used splints. The splints are manufactured from soft aluminium which makes them X-ray translucent and ensures ease of application. The Splints are malleable and can easily be formed to fit each patient exactly. Each kit contains 5 different splints in a variety of sizes for a total of 25 splints.



Burnshield Combi Trauma Pack Codes BTBS-KCT

The Burnshield Combi Trauma Pack is an advanced burns trauma bag for use by ambulance, fire, defence and industry personnel.

Contents

- 5 x Burnshield Dressing (10 cm x 10 cm)
- 5 x Burnshield Dressing (20 cm x 20 cm)
- 3 x Burnshield Dressing (60 cm x 40 cm)
- 2 x Burnshield Blanket (80 cm x 80 cm)
- 5 x Burnshield Dressing (2.5 cm x 50 cm)
- 3 x Burnshield Dressing (5 cm x 100 cm)
- 2 x Burnshield Hydrogel (1 L)
- 4 x Burnshield Hydrogel (125 ml)
- 2 x Crepe bandage (10 cm)
- 1 x Crepe bandage (15 cm)
- 1 x Rescue Blanket (adult)
- 2 x Purified water
- 1 x Scissors
- 1 x Syringe (20 ml)
- 2 x Latex gloves (pair)
- 1 x Plastipore (2.4 cm x 5 m)



Burnshield Responder Kit Codes BTBS-KR

The Burnshield Responder Kit is a trauma kit that is used by professionals who deal with trauma cases such as doctors, paramedics, nursing staff and ambulance personnel. This one bag caters for minor, moderate and severe burns.

- 8 x Burnshield Dressing (10 cm x 10 cm)
- 3 x Burnshield Dressing (20 cm x 20 cm)
- 2 x Burnshield Dressing (60 cm x 40 cm)
- 1 x Burnshield Dressing (2.5 cm x 50 cm)
- 1 x Plastipore (2.4 cm x 5 m)
- 1 x Rescue Blanket (adult)
- 2 x Latex gloves (pair)
- 3 x Burnshield Hydrogel (125 ml)
- 2 x Sterile water ampoules
- 1 x Syringe (20 ml)
- 2 x Conforming bandage (7.5 cm)
- 1 x Scissors



Burnshield Rescue Burns Kit Codes BTBS-KE

The Burnshield Rescue Burns Kit is a moderate sized trauma kit that is used by basic, intermediate and advanced life support professionals who deal with first response and trauma cases.

- 2 x Burnshield Dressing (10 cm x 10 cm)
- 2 x Burnshield Dressing (20 cm x 20cm)
- 2 x Burnshield Dressing (60 cm x 40 cm)
- 1 x Burnshield Dressing (5 cm x 100 cm)
- 1 x Plastipore (2.4 cm x 5 m)
- 2 x Conforming bandage (5 cm)
- 1 x Burnshield Hydrogel (125 ml)
- 1 x Scissors
- 1 x Latex gloves (pair)
- 1 x Rescue blanket



Easy Care Burn Kit Code BTBS-KEC

The EasyCare Burn Kit provides the basic content to treat a mild to moderate emergency burn in the workplace or home. All content is housed in a protective plastic case.

- 1 x Burnshield plastic box
- 2 x 10cm x 10cm dressing
- 1 x 20cm x 20cm dressing
- 3 x Burn Blotts 3.5 ml
- 3 x Adhesive plasters
- 1 x Paper tape 25 cm x 3 m
- 1 x Latex gloves pair
- 1 x Scissors
- 2 x Conform bandage 50 mm



Burnshield Fire/Trauma Blankets

Codes BTBS-B1x1 (1 m x 1 m), BTBS-B1.2x1.6 (1.2 m x 1.6 m), BTBS-B2.45x1.6 (2.45 m x 1.6 m)

Burnshield Fire/Trauma Blankets are made from pure wool that is impregnated with Hydrogel, which provides remarkable heat protection and extended burn-through times. The blanket can be used with confidence as a fire shield or be placed over a burning victim to stop the flame, while at the same time providing first aid treatment to the burns. Burnshield blankets are packaged in a portable hands free bag and are available in a variety of sizes.



Burnshield Dressings

Burnshield halts the burn process and protects against further contamination. Its cooling Hydrogel is made from Melaleuca Alternifolia (tea-tree). The non-adhesive, sterile dressing keeps the wound clean and is easy to apply and remove.

Available Sizes

- BTBS-D10 x 10 (10 cm x 10 cm)
- BTBS-D20 x 20 (20 cm x 20 cm)
- BTBS-D20 x 45 (20 cm x 45 cm)
- BTBS-D60 x 40 (60 cm x 40 cm)
- BTBS-D2.5 x 50 (2.5 cm X 50 cm)
- BTBS-D5 x 100 (5 cm x 100 cm)
- BTBS-D20 x 45F - face mask (20 cm x 45 cm)
- BTBS-D60 x 40F - face mask (60 cm x 40 cm)
- BTBS-DR100 x 100 (100 cm x 100 cm)
- BTBS-DR100 x 200 (100 cm x 200 cm)



Burnshield Hydrogel

Codes BTBS-H50ML (50 ml), BTBS-H125ML (125 ml spray back) and BTBS-SB (3.5 ml sachet)

Burnshield Hydrogel is a sterile, water-based solution that is anti-microbial, anaesthetising and cooling. It can be applied directly to any burn quickly relieving pain by cooling, moisturising and soothing the skin while protecting the burned area from contamination.



Ferno Stocked First Aid Kits

Ferno offer a low cost range of stocked First Aid Kits that cater for the absolute basic personal requirements to a more comprehensive car, home or workplace. Each kit has a convenient belt loop to carry on person.

Pocket First Aid Kit (Small)

- Gauze swab 5 x 5 cm pk 2
- CPR Shield 1
- First aid guide 1
- Wound wipes 1
- Disposable Latex Gloves 1
- Tweezers 8cm 1
- Alcohol wipes 1
- Resealable bag - small 1
- Adhesive strips 10
- Adhesive mini strips 5
- Splinter probes 2



HIKERS/ PERSONAL KIT First Aid Kit (Medium)

- Adhesive strips 20
- Adhesive mini strips 5
- Adhesive square plasters 1
- Splinter probes 5
- Latex Gloves 1
- Safety pins 5
- Tweezers 8cm 1
- Scissors 8 cm 1
- Alcohol wipes 3
- Resealable bag - small 1
- Comb pad 10 x 10 cm 1
- CPR Shield 1
- First aid guide 1
- Note pad 1
- Pencil 1
- Wound wipes 2
- Bandage conforming 5cm 1
- Bandage conforming 7.5cm 1
- Cotton buds 5
- Triangular bandage 1
- Gauze swab 5 x 5 cm pk 2
- Adhesive tape 1.25cm 1



UNIVERSAL "C" WORKPLACE SPEC KIT (1 - 10 users) Home / Car First Aid Kit (Large)

- Adhesive strips 50
- Adhesive square plasters 3
- Resealable bag - small 2
- Resealable bag - medium 2
- Bandage conforming 5cm 1
- Bandage conforming 7.5cm 1
- Resealable bag - medium 2
- Bandage conforming 5cm 1
- Bandage conforming 7.5cm 1
- Gauze swab 5 x 5 cm pk 2 1
- Adhesive tape 1.25cm 1
- Wound dressing #15 1
- Triangular bandage 1
- CPR Shield 2
- Saline 15ml 2
- First aid guide 1
- Note pad 1
- Pencil 1
- Cotton buds 10
- Cotton balls 10
- Triangular bandage 1
- Non-adh pad 10 x 7.5cm 2
- Non-adh pad 5 x 7.5cm 2
- Wound wipes 4
- Splinter probes 5
- Latex Gloves 2
- Safety pins 10
- Tweezers 8cm 1
- S/S Scissors 1
- Alcohol wipes 5
- Cotton buds 10
- Cotton balls 10
- Eye pad 2



Ferno ALS Kit Contents Codes FWE-ALSC

The Ferno ALS Kit contents provide a comprehensive range of product that can be supplied with either your choice of Ferno 5108 Professional ALS Kit or the R300 Paramedic Rescue Backpack. (kit contents supplied separately to bag)

Contents

Bandages & Dressings:

- 2 Triangular Bandages
- 1 Combine Dressing 20 cm x 75 cm
- 2 #15 Wound Dressing
- 1 Pkt 50 Fabric Adhesive Dressings
- 2 Algisite Dressing 5 cm x 5 cm
- 2 Burnshield Dressing 10 cm x 10 cm
- 1 Paraffin Gauze Dressing 10 cm x 10 cm
- 2 Conforming Gauze Bandage 7.5 cm
- 2 Conforming Gauze Bandage 15 cm
- 5 Pkt 5 Gauze Swabs 10 cm x 10 cm
- 1 Heavy Crepe Bandage 7.5 cm
- 1 Heavy Crepe Bandage 7.5 cm
- 5 Eye Pads
- 2 Leukoplast Adhesive Tape 2.5 cm
- 1 Leukoplast Adhesive Tape 1.25 cm
- 1 Disposable Basic Dressing Pack

Advanced Life Support:

- Advanced Life Support:
- 1 Disposable Resuscitator (Adult)
- 1 Set 6 Nasopharyngeal Airways
- 1 Set 5 Guedel Airways



Equipment & Supplies

- 1 Sphygmomanometer 1 Hand
- 1 Stethoscope
- 1 Ferno CPR Mask
- 1 Eye Wash
- 1 Sam Splint 36"
- 5 Pr Nitrile Gloves
- 1 Universal Shears
- 1 Bandage Scissors
- 1 Kelley Forceps
- 1 Splinter Tweezers
- 1 Space Blanket
- 1 Burn Dressing 70 cm x 75 cm
- 10 Povidone Iodine Prep Pads
- 10 Alcohol Prep Pads
- 10 Antiseptic Cream Satchets 1 ml
- 1 Stingose Gel 25 g
- 1 Instant Ice Pack
- 1 Oral Glucose Gel
- 1 Ipecac Syrup
- 1 Disposable Scalpel
- 1 No-Rinse Hand Gel

Ferno BLS Kit Contents Codes FWE-BLSC

The Ferno BLS Kit contents provide basic equipment and dressings required during a medical emergency. These contents can be supplied with the Ferno 5107 Professional Trauma Kit, Ferno 5103 Trauma Responder II Kit or the Ferno R400.Primary Response Kit (kit contents supplied separately to bag)

Contents

Bandages & Dressings:

- 2 Triangular Bandages
- 1 Combine Dressing 20 cm x 75 cm
- 1 #15 Wound Dressing
- 1 Pkt 50 Fabric Adhesive Dressings
- 2 Algisite Dressing 5 cm x 5 cm
- 2 Burnshield Dressing 10 cm x 10 cm
- 1 Paraffin Gauze Dressing 10 cm x 10 cm
- 2 Conforming Gauze Bandage 7.5 cm
- 2 Conforming Gauze Bandage 15 cm
- 5 Pkt 5 Gauze Swabs 10 cm x 10 cm
- 1 Heavy Crepe Bandage 7.5 cm
- 1 Heavy Crepe Bandage 7.5 cm
- 5 Eye Pads
- 2 Leukoplast Adhesive Tape 2.5 cm
- 1 Leukoplast Adhesive Tape 1.25 cm



Equipment & Supplies

- 1 Set 5 Guedel Airways
- 1 Sphygmomanometer 1 Hand
- 1 Stethoscope
- 1 Eye Wash.
- 1 Sam Splint 36"
- 5 Pr Nitrile Gloves
- 1 Universal Shears
- 1 Bandage Scissors
- 1 Kelley Forceps
- 1 Splinter Tweezers
- 1 Space Blanket
- 1 Ferno CPR Mask
- 1 Burn Dressing 70 cm x 75 cm
- 10 Povidone Iodine Prep Pads
- 10 Alcohol Prep Pads
- 10 Antiseptic Cream Satchets 1 ml
- 1 Stingose Gel 25 g
- 1 Instant Ice Pack
- 1 No-Rinse Hand Gel

Oxy-Therapy & Oxy-Resusc Kit Contents

Code OXK-R (Oxy-Resusc Kit Contents) OXK-T (Oxy-Therapy Kit Contents)

The Oxy-Resusc Kit Contents were developed as an emergency resuscitation kit and can be utilised by industry through to first response emergency personnel. The Oxy-Resusc Kit Contents can be purchased without the adult resuscitator and airways (Oxy-Therapy Kit Contents) which is suitable for the delivery of oxygen therapy in the home or workplace. Both kits provides for the supply of oxygen therapy and can be used in an emergency to resuscitate using the Ferno E-Mask. The ideal softpack to store the contents is the FAHAD5120 as displayed.

Contents

- Multiflow regulator 0.25 to 25 LPM
- Three adult and child therapy masks
- Pocket mask with O₂ inlet, face strap and case
- Cylinder spanner
- Adult resuscitator, adult & child mask *
- Guedel airways sizes one to five *

* Not supplied with Oxy-Therapy Kit Contents.



Oxy-Demand Kit Contents

Code OXK-D

The Oxy-Demand Kit Contents are designed for use by those highly trained in oxygen resuscitation. It offers oxygen on-demand, oxygen therapy plus an extra high pressure outlet. This allows for inclusion of an additional high pressure resuscitation line or venturi suction system. The ideal softpack to store the contents is the FAHAD5100 or the FAHAD2140.

Contents

- Multiflow regulator with two high pressure outlets
- Oxygen demand valve with mask and tubing
- Three adult and child therapy masks
- Airway sizes one to five
- Pocket mask with O₂ inlet, face strap and case
- Cylinder spanner

Kit contents exclude oxygen cylinder and softpack.



Oxy-Medic Kit Contents

Code OXK-M

The Oxy-Medic Kit Contents have all the same features as the Oxy-Resusc Kit with the added benefit of a venturi suction system. Kit contents exclude oxygen cylinder and softpack. Kit contents can be purchased individually. The ideal softpack to store the contents is the FAHAD 5100 as displayed, or the FAHAD 2140 .

Contents

- Multiflow regulator with two high pressure outlets
- Adult resuscitator with adult and child mask
- Oxygen powered suction unit
- Three adult and child therapy masks
- Guedel airways sizes one to five
- Pocket mask with O₂ inlet, face strap and case
- Cylinder spanner

Kit contents exclude oxygen cylinder and softpack



Oxy-Rescue Kit Contents

Code OXK-RV

The Oxy-Rescue Kit Contents are for use by personnel highly trained in the delivery of oxygen resuscitation. It has the same features as the Oxy-Demand Kit but has the added benefit of a venturi suction system. The Oxy-Rescue Kit can also be used with various Ferno softpacks. The ideal softpack to store the contents is the FAHAD 5100 as displayed, or the FAHAD 2140.

Contents

- Multiflow regulator with two high pressure outlets
- Oxygen demand valve with mask and tubing
- Oxygen powered suction unit
- Three adult and child therapy masks
- Airways sizes one to five
- Pocket mask with O₂ inlet, face strap and case
- Cylinder spanner

Kit contents exclude oxygen cylinder and softpack.



Ferno Ventilation Kits

Ferno's Ventilation Kits provide a lightweight, mobile and very compact emergency airway, resuscitation and ventilation system designed for controlled ventilation of emergency transport patients. The various kits cater for a range of ventilation and resuscitation skill sets, from the trained but infrequent user to the advanced specialist. The kits are ideal for emergency transport, remote area medical centres, oil rigs and mines. Shown fully optioned in the Ferno Airway Management/Oxygen Kit 5100.

ALS Ventilation Kit

The ALS Ventilation Kit includes the Weinmann Medumat Easy CPR which provides voice commands to guide the user the CPR process.

Paramedic Ventilation Kit

The Paramedic Ventilation Kit includes the Weinmann Medumat Standard A which offers controlled and assisted ventilation with fixed minute volume (SIMV) This can be further enhanced with the optional Weinmann Modul CPAP for treatment of acute pulmonary oedema.

Base Ventilation Kit Contents

- Spiracle Bravo2 Oxygen Regulator
- Oxygen Powered Suction Unit
- Ferno Single Use Adult Resuscitator
- Child Single Use Resus Mask Size 3
- Y-Suction Catheter Size 12 & 14
- Yankuer Suction Unit
- Guedel Airways Size 2, 3, 4 & 5
- Nasopharyngeal Airway Size 6 & 7
- Laryngeal Mask Airway Size 3, 4 & 5
- Weinmann Medumat Easy CPR (ALS Kit)
- Weinmann Medumat Standard A (Paramedic Kit)
- Modul CPAP complete (Paramedic Kit)



Shown fully optioned in the Ferno Airway Management/Oxygen Kit 5100



Medumat Easy CPR
(ALS Ventilation Kit)



Medumat Standard A
(Paramedic Ventilation Kit)



Weinmann Modul CPAP
(Paramedic Ventilation Kit)

Ferno Intubation Kit *Code TBA*

The Ferno Intubation Kit contains the basic equipment required to perform emergency intubation in the field. All contents are conveniently positioned for quick retrieval in our practical Ferno 5115 Intubation Mini Kit.

Contents

- Ferno Professional Intubation Mini Kit
- Laryngoscope Fibre Optic Handle
- Single Use Fibre Optic Mac Blade 2, 3 & 4
- ET Tube Cuffed Size 6, 7, 8 & 9
- Intubation Stylet
- KY Gel Satchel
- Magill Forceps
- ET Tube Holder
- Syringe 3 ml & 10 ml
- Littman Classic II Stethoscope
- Spare Batteries



Ferno Single Use Resuscitators *Codes RBMF-AD (Adult), RBMF-CD (Child) and RBMF-ID (Infant)*

Inexpensive and so effective you won't believe they are disposable, the Ferno Single Use Resuscitators are 100% latex-free. The highly polished PVC bag, valve housing and mask allow the operator to view critical function areas. The soft feel provides good feedback, while the resilient construction allows for quick stroke deliveries. Ferno Single Use Resuscitators are completely disposable, eliminating the need to clean, disinfect or sterilise the device. The patient valve incorporates a vomit deflector/peep valve adaptor. Available in adult, child and infant sizes. A full range of air-cushioned masks are also available. Contents include Bag, Mask, Patient and Intake Valves, Reservoir Bag & 2 m of O₂ drive-line.



Ferno Silicone Resuscitators *Codes RBMF-AR (Adult), RBMF-CR (Child) and RBMF-IR (Infant)*

The fully autoclavable Ferno Silicone Resuscitators offer great value and exceptional quality. They are manufactured to the highest standards using 100% latex-free, transparent silicone. The Resuscitators have exceptional recoil which allows for quick stroke deliveries. The high polished silicone bag, valve housing and mask allow the operator to view critical function areas, while the soft feel provides good feedback. The transparent durable silicone used enables inspection before, during and after use. The Ferno Reusable Resuscitator has total disassembly for cleaning and optional pop-off valves on adult sizes (this is a standard feature on child and infant versions). A full range of mask sizes are also available. Contents include Bag, Mask, Patient and Intake Valves, Reservoir Bag & 2 m of O₂ drive-line.



Ferno Resuscitation Masks

Available in reusable or single use. Fits standard 15/22 mm connectors. Ferno Reusable Masks have a see through body with a unique multi-function mask cover that provides an airtight seal while providing patient comfort. Latex Free. Ferno Single Use Masks are contoured with an anatomically shaped cushion that provides a gas tight low pressure seal. Hypo-allergenic materials.

| Title | Code | Title | Code |
|-----------------------|--------|-------------------|--------|
| Adult Reusable | RRMM-5 | Adult Single Use | RRMM-A |
| Child/Adult Reusable | RRMM-4 | Child Single Use | RRMM-C |
| Child Reusable | RRMM-5 | Infant Single Use | RRMM-I |
| Infant/Child Reusable | RRMM-2 | | |
| Infant | RRMM-1 | | |
| Infant | RRMM-0 | | |



Ferno E-Mask *Codes RMF-EM (mask) and RMF-EMOWV (one-way valve/filter)*

The one-way valve and directional diaphragm on the Ferno E-Mask allows no backflow of air or contaminants (fluids) to pass from the patient to rescuer/rescuer to patient and provides superior protection against viruses and bacteria. The Ferno E-Mask comes with an O₂ port, head-strap and hard shell case. Fittings are a standard 22 mm and can be used with any Ferno resuscitator. The Ferno E-Mask fits both adult and child patients. Once used, the mask can be sterilised and a replacement one-way valve/filter can be fitted.



Keyring Resuscitation Masks *Code RMAG-K*

Keyring Resuscitation Masks are a convenient way of ensuring that you are always prepared whenever an emergency situation arises. Keyring Resuscitation Masks provide rescue breathing protection and come conveniently packed in a durable woven nylon keyring case.



Spiracle BRAVO₂ Oxygen Regulator *Codes OXR-S831A and OXR-S833A*

The new Australian Standards approved Spiracle BRAVO₂ Oxygen Regulator is supplied with two Australian compatible high pressure outlets. Constructed from a solid piece of brass, the uni-body style regulator with internal brass components provide a safe and effective regulator. The proven and durable Spiracle BRAVO₂ Oxygen Regulator comes with or without high pressure outlets.



Product details

- OXR-S831A: 11 flow rates 0.25 to 25 LPM and 2 HP outlets
- OXR-S833A: 11 flow rates 0.25 to 25 LPM

Series-O Regulators *Code OXR-CC*

The Comweld Series-O Regulator has been the industry leader in Australia for many years. The simple but effective design and ease of use make these single stage regulators a very low maintenance yet high performing product that can be used in a variety of environments.



Flow Meters *Ball/Chamber 515800 Code OXFM-B Gauge Type TM17 Code OXFM-G*

These pressure compensated flow meter delivers an accurate prescribed gas flow from 0 to 15 LPM with accuracy of + - 5%. Suitable for most types of respiratory therapy. When the ball/chamber type is not suitable the Gauge Type provides accurate flow at any positional orientation.

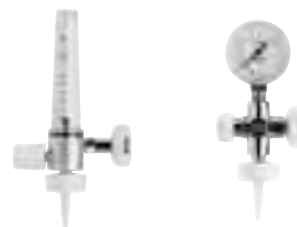

Micro-Manager O₂ Administrator *Code OXR-903*

The Micro Manager delivers a preset constant flow of oxygen to multiple patients and can be configured for use with either 2, 4, 6, 10 or 15 LPM DISS barbed fittings, or a combination of fittings to meet specific emergency needs. Each Micro Manager can service up to five (5) patients. The unit may also be connected in sequence to additional Micro Managers, increasing the number of treated patients. The Micro Manager is a perfect addition to any ambulance, major incident response kit/trailer or oxygen resuscitation kit where multiple patient oxygen delivery is required. Comes standard with either five 2 Lpm, 4 Lpm, 6 Lpm, 10 Lpm or 15 Lpm screw on outlets.



Oxygen Demand Valve *Code OXD*

The Oxygen Demand Valve provides a fast, simple and effective means to ventilate non-breathing patients or provide 100% oxygen on demand to patients suffering from respiratory distress. The Oxygen Demand Valve comes with an audible pressure relief system and manual ventilation button, hose and resuscitation mask.



HFOC High Flow Oxygen Conserver *Code OXD-HFOC*

The HFOC High Flow Oxygen Conserver addresses the need to deliver 100% oxygen during resuscitation and performs the function regardless of resuscitator rate and bag stroke volume. The HFOC operates from any standard 50 psi gaseous oxygen source and has an integral back pressure relief diaphragm which functions to relieve pressure greater than atmospheric. Adapters are available to attach to most popular brands of bag valve resuscitators. Comes with 1 x 180 cm O₂ supply hose.



Weinmann Medumat Standard A

Medumat Standard A offers controlled ventilation as well as an assisted ventilation mode with fixed minute volume (SIMV). Other functions such as oxygen inhalation or secretion suction can be added via the Modul system. Electronic alarms warn of disconnection, stenosis, pressure decrease in oxygen supply, insufficient battery voltage, system failure and missed triggering in assisted ventilation mode.

Supply Schedule:

- WM-22800 Medumat Standard A complete
- WM-22670 Wall mount bracket (20G force)
- WM-22520 Reusable patient hose system with patient valve
- WM-28110 Disposable patient hose system with patient valve



Weinmann Modul CPAP

A simple oxygen driven CPAP device for the treatment of acute pulmonary oedema in the emergency environment. Utilising a Boussignac valve to create the CPAP pressure the Modul CPAP takes over the supply, management and monitoring of your patient. A robust device for the emergency environment the Weinmann Modul CPAP provides the following benefits.

Supply Schedule:

- WM-29125 Weinmann Modul CPAP complete with airway
- WM-29119 Complete Boussignac Valve



Weinmann Medumat Easy

Ideal for remote nursing, mines, oil rigs or the trained but infrequent user. The Medumat Easy provides simple and sure guidance through volume ventilation thanks to its single-button operation and easy to understand voice prompts, the user can concentrate completely on the patient. The ventilation is started in standard mode for use with a mask. With the press of a button the user can switch to invasive ventilation.

Supply Schedule:

- WM-28000 Medumat Easy Ventilator complete
- WM-22520 Reusable patient hose system with patient valve
- WM-28110 Disposable patient hose system with patient valve



Weinmann Medumat Easy CPR

A voice guided ventilator optimised for cardiopulmonary resuscitation. The Weinmann Medumat Easy CPR is extremely safe and easy to use. Ideal for remote areas such as mines, oil rigs and remote area medical centres. The Medumat Easy CPR can be used as ventilator or used in resuscitation situations where the device guides the user through the CPR process giving key voice commands and correct timing for chest compressions. The ventilator lets you manually generate a ventilated breath using the Medutrigger on the mask.

Supply Schedule:

- WM-28140 Medumat Easy CPR Ventilator complete
- WM-22520 Reusable patient hose system with patient valve
- WM-28110 Disposable patient hose system with patient valve



Medutrigger on the mask

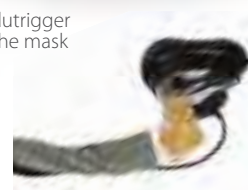

Weinmann Accuvac Rescue

The Accuvac Rescue can be used anywhere because it adapts immediately to any suction need. Electronic controls allow finite adjustment for each situation and the Accuvac Rescue is highly portable and tough enough to deal with extreme weather conditions. As a 12 volt unit the Accuvac Rescue is independent from a stationary power supply so that it can work at the scene of an emergency or in a rescue vehicle. In addition to its use as suction pump for airway suction, it can also be used to deflate vacuum splints and mattresses. Available with reusable or disposable collection canister. Optional wall mounting bracket available.



Supply Schedule:

- WM-10609 Accuvac Rescue with 12 volt power connection/charger & disposable canister, accessory bag and wall bracket
- WM-10620 Accuvac Rescue with 12 volt power connection/charger & reusable canister, accessory bag and wall bracket
- WM-15208 Wall bracket
- WM-10655 Accessory bag for Accuvac units
- WM-15268 Disposable canister set
- WM-2610 Power pack and battery charger for 240 volt AC



Reusable Canister



Wall bracket (240v compatible)

| Width | Height | Depth | Weight | Operating Temperature | Suction Capacity |
|--------|--------|--------|--------|-----------------------|------------------|
| 370 mm | 280 mm | 140 mm | 5.1 kg | -18 to +40 °C | 20 L/min |

Weinmann Accuvac Basic

Accuvac Basic fulfills the requirements for quick, safe and effective aspiration of patients. All the functions have been ergonomically designed. The device permits adaptation to every suction situation thanks to its infinitely variable negative pressure regulation. The Accuvac Basic is highly portable and tough enough to deal with extreme weather conditions. Equally important is independence from a stationary power supply so that it can work at the scene of an emergency or in a rescue vehicle. In addition to its use as a suction pump for airway suction, it can also be used to deflate vacuum splints and mattresses. Available with reusable or disposable collection canister. Optional wall mounting bracket with charger available.



Supply Schedule:

- WM-10700 Accuvac Basic with 240 volt charger & disposable canister
- WM-10709 Accuvac Basic with 240 volt charger & reusable canister
- WM-15208 Wall bracket
- WM-10655 Accessory bag for Accuvac units
- WM-10630 Reusable canister complete with hose
- WM-15238 Disposable canister complete with hose



Disposable Canister



Wall bracket (240v compatible)

| Width | Height | Depth | Weight | Operating Temperature | Suction Capacity |
|--------|--------|--------|--------|-----------------------|------------------|
| 385 mm | 280 mm | 140 mm | 5.4 kg | -18 to +40 °C | 20 L/min |

Laerdal Compact Suction Unit 3 (300 ml) Code LAER-88006040

LCSU 3 is one of the smallest battery powered suction units on the market today. Its weight of 1.53 kg and small size enables you to carry it in your airway bag to every call. Variable vacuum regulator and LED display gives you the capacity and control you need to quickly clear a blocked airway. Includes: LCSU 3 Suction Unit, 300 ml Disposable Canister, Bacterial Filter, Internal Battery, AC to DC Adapter/Charger, AC Power Cord, and Directions for Use.



Oxygen Powered Suction Unit *Code OXSU-OP*

The Oxygen Powered Suction Unit is capable of fast effective suctioning of excess quantities of fluid and particles from a patient's airway. The unique on/off button allows for fast, effective suction in emergency situations. Each suction unit comes complete with a catheter ready for immediate use.



Ferno Manual Vacuum Pump *Code OXSM-F*

The Ferno Manual Vacuum Pump (MVP) is a robust, light, portable high vacuum with a manual vacuum pump used for the clearing of airway obstructions. This is the only unit available that has the added benefit of being able to disengage and rotate the handle 360° relative to the patient's position, providing accessibility in tight situations.

Key Features

- 300 ml disposable collection jar
- 6 mm and 13 mm disposable suction catheters
- Overflow protection mechanism



Weinmann Manuvac *Code WM-10800*

The reliable helper in any emergency the Manuvac can be operated by hand, foot or knee. The design is compact, rugged and maintenance-free. A reliable suction device for any case.

| Width | Height | Depth | Weight | Suction Capacity |
|--------|--------|--------|--------|------------------|
| 205 mm | 175 mm | 105 mm | 1.4 kg | 160 L/stroke |



The Sam Chest Seal

The Sam Chest Seal is an occlusive dressing designed for treating open chest wounds, a life-threatening situation that could lead to tension pneumothorax, the second-leading cause of preventable death on the battlefield.

The Sam Chest Seal will adhere to skin that is subject to sweat, blood, hair, sand or water and has the ability to reseal, making it ideal for venting. It has a large coverage area, two dressings per pouch (non-valve version), and the inclusion a large absorbent pad. The outer package has tear notches at each side and provides the medic with a sterile field. The Sam Chest Seal and packaging is optimised for night vision. Subject to TGA registration.



Laryngoscope Systems

Ferno offers a full range of laryngoscope blades and handles in various sizes including fibre optic blades and matching handles, halogen blades and handles as well as a full range of single use blades.



| Disposable | Type | Size | Blade | Halogen | Type | Size | Blade | Fibre optic | Type | Size | Blade |
|------------|------------------------|------|-----------|-----------|----------------|------|-----------|-------------|--------------------|------|-----------|
| AWLH-FO | Fibreoptic Handle | - | - | AWLH | Halogen Handle | - | - | AWLH-FO | Fibre optic Handle | - | - |
| AWLB-0MILD | Disposable Fibre optic | 0 | Miller | AWLB-0MIL | Halogen | 0 | Miller | AWLB-0MILFO | Fibre optic | 0 | Miller |
| AWLB-1MILD | Disposable Fibre optic | 1 | Miller | AWLB-1MIL | Halogen | 1 | Miller | AWLB-1MILFO | Fibre optic | 1 | Miller |
| AWLB-2MILD | Disposable Fibre optic | 2 | Miller | AWLB-2MIL | Halogen | 2 | Miller | AWLB-2MILFO | Fibre optic | 2 | Miller |
| AWLB-2MCD | Disposable Fibre optic | 2 | Macintosh | AWLB-2MC | Halogen | 2 | Macintosh | AWLB-2MCFO | Fibre optic | 2 | Macintosh |
| AWLB-3MCD | Disposable Fibre optic | 3 | Macintosh | AWLB-3MC | Halogen | 3 | Macintosh | AWLB-3MCFO | Fibre optic | 3 | Macintosh |
| AWLB-4MCD | Disposable Fibre optic | 4 | Macintosh | AWLB-4MC | Halogen | 4 | Macintosh | AWLB-4MCFO | Fibre optic | 4 | Macintosh |

Guedel/Oral Airway

| | Size | Colour | Length | | Size | Colour | Length |
|----------|------|--------|--------|--------|------|-------------|--------|
| AWG-000D | 000 | Pink | 30 mm | AWG-3D | 3 | Green | 80 mm |
| AWG-00D | 00 | Orange | 40 mm | AWG-4D | 4 | Yellow | 90 mm |
| AWG-0D | 0 | Blue | 50 mm | AWG-5D | 5 | Red | 100 mm |
| AWG-1D | 1 | Violet | 60 mm | AWG-6D | 6 | Water green | 110 mm |
| AWG-2D | 2 | White | 70 mm | | | | |



Intubation Stylet

| | Size (Fr.) | Recommended Tube I.D. | Length |
|--------|------------|-----------------------|--------|
| AWIS-S | 6 | 2.5 mm – 4.5 mm | 280 mm |
| AWIS-M | 10 | 4 mm – 6 mm | 350 mm |
| AWIS-L | 14 | 5 mm | 350 mm |

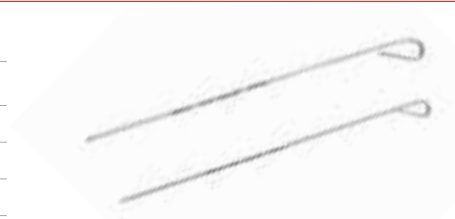

Endotracheal Tubes Cuffed and Uncuffed

| | ID | OD | Length | | ID | OD | Length |
|-----------|--------|---------|--------|------------|--------|--------|--------|
| AWET-T3 | 3 mm | 4.3 mm | 190 mm | AWET-TU2 | 2 mm | 2.9 mm | 171 mm |
| AWET-T3.5 | 3.5 mm | 4.9 mm | 213 mm | AWET-TU2.5 | 2.5 mm | 3.6 mm | 171 mm |
| AWET-T4 | 4 mm | 5.6 mm | 232 mm | AWET-TU3 | 3 mm | 4.3 mm | 190 mm |
| AWET-T4.5 | 4.5 mm | 6.2 mm | 253 mm | AWET-TU3.5 | 3.5 mm | 4.9 mm | 213 mm |
| AWET-T5 | 5 mm | 6.9 mm | 274 mm | AWET-TU4 | 4 mm | 5.6 mm | 232 mm |
| AWET-T5.5 | 5.5 mm | 7.5 mm | 304 mm | AWET-TU4.5 | 4.5 mm | 6.2 mm | 253 mm |
| AWET-T6 | 6 mm | 8.2 mm | 317 mm | AWET-TU5 | 5 mm | 6.9 mm | 274 mm |
| AWET-T6.5 | 6.5 mm | 8.8 mm | 327 mm | AWET-TU5.5 | 5.5 mm | 7.5 mm | 304 mm |
| AWET-T7 | 7 mm | 9.6 mm | 339 mm | AWET-TU6 | 6 mm | 8.2 mm | 317 mm |
| AWET-T7.5 | 7.5 mm | 10.2 mm | 350 mm | AWET-TU6.5 | 6.5 mm | 8.8 mm | 327 mm |
| AWET-T8 | 8 mm | 10.9 mm | 360 mm | AWET-TU7 | 7 mm | 9.6 mm | 337 mm |
| AWET-T8.5 | 8.5 mm | 11.5 mm | 370 mm | | | | |
| AWET-T9 | 9 mm | 12.1 mm | 375 mm | | | | |
| AWET-T9.5 | 9.5 mm | 12.8 mm | 375 mm | | | | |
| AWET-T10 | 10 mm | 13.5 mm | 375 mm | | | | |



Nasopharyngeal Airways

| | Size (Fr.) | ID | OD |
|----------|------------|--------|---------|
| AWNA-2.5 | 12 | 2.5 mm | 4 mm |
| AWNA-3.0 | 14 | 3 mm | 4.7 mm |
| AWNA-3.5 | 16 | 3.5 mm | 5.3 mm |
| AWNA-4.0 | 18 | 4 mm | 6 mm |
| AWNA-4.5 | 19 | 4.5 mm | 6.3 mm |
| AWNA-5.0 | 20 | 5 mm | 6.7 mm |
| AWNA-5.5 | 22 | 5.5 mm | 7.3 mm |
| AWNA-6.0 | 24 | 6 mm | 8.1 mm |
| AWNA-6.5 | 26 | 6.5 mm | 8.7 mm |
| AWNA-7.0 | 28 | 7 mm | 9.4 mm |
| AWNA-7.5 | 30 | 7.5 mm | 10 mm |
| AWNA-8.0 | 32 | 8 mm | 10.8 mm |
| AWNA-8.5 | 34 | 8.5 mm | 11.4 mm |
| AWNA-9.0 | 36 | 9 mm | 12 mm |



Laryngeal Mask Airway

| | Patients | Weight | Size |
|---------|------------------|-----------|------|
| AWLM-1D | Neonates/infants | 5 kg | 1 |
| AWLM-2D | Infants/children | 10-20 kg | 2 |
| AWLM-3D | Children | 30-50 kg | 3 |
| AWLM-4D | Adults | 50-70 kg | 4 |
| AWLM-5D | Adults | 70-100 kg | 5 |



HeartStart HS1 First Aid Defibrillator

The HeartStart HS1 First Aid Defibrillator is simple to operate; with minimal training required an individual could easily use this device to save a life. The clear and concise voice instructions prompt the user through the steps of first aid defibrillation and CPR. The HeartStart HS1 First Aid Defibrillator has a comprehensive automatic self-test that checks all the vital functions on a daily, weekly and monthly schedule. An optional and economical HS1 AED Trainer is also available

Supply Schedule

| | |
|-----------------|---|
| LAER- M5066AABU | HS1 Defibrillator with battery pack, electrode set & slimline case |
| LAER-M5071A | Adult SMART defibrillator electrode set |
| LAER-5072A | Infant / Child SMART defibrillator electrode set |
| LAER-M5070A | Battery, lithium manganese dioxide |
| LAER- M5086A | HS1 AED trainer with adult training pad cartridge, manikin adapter strip and carry case |
| LAER-M5073A | Adult training pads with cartridge |
| LAER-M5074A | Infant / Child training pads |
| LAER-M5093A | Adult training pads without cartridge |



HS1 AED Trainer

HeartStart FRx Defibrillator

The HeartStart FRx Defibrillator is a semi-automatic external defibrillator that is rugged, reliable and designed to be easy to use for those first to arrive at an emergency situation. It incorporates a number of features to ensure readiness with minimum maintenance. The HeartStart FRx Defibrillator is simple to operate, with minimal training an individual could easily use this device to save a life. The clear and confident voice instructions coach the first aider through each step of first aid defibrillation and CPR. The HeartStart FRx Defibrillator is always ready with comprehensive automatic self-tests of all vital functions on a daily, weekly and monthly schedule.

Supply Schedule

| | |
|-------------------|---|
| LAER-861304ABU | FRx defibrillator, battery pack, electrode set and carry case |
| LAER-989803139261 | Smart pads defibrillator electrode set |
| LAER-989803139311 | Infant/child key |
| LAER-989803139271 | Training pads adult (one pair) |
| LAER-M5070A | Battery lithium manganese dioxide |



HeartStart FR3 Defibrillator

The new HeartStart FR3 is designed to significantly reduce deployment time to deliver CPR or defibrillation. The FR3 automatically powers on by opening the carry case and pre-connected patient pads can be used for adults or children. An optional infant/child key automatically configures the FR3 for infant/child CPR protocols. Bright, high-resolution colour LCD. Dust and water protection for demanding work environments. Optional data card for event recording. An optional FR3 AED Trainer is also available.

Supply Schedule

| | |
|--------------------|--|
| LAER-861388 | FR3, battery, electrode set and carry case |
| LAER-861389 | FR3 with ECG, battery, electrode set, carry case |
| LAER-989803149981 | 1 set Smart pads III electrode set |
| LAER-989803149991 | 5 set Smart pads III electrode set |
| LAER-989803150161 | Primary battery |
| LAER- 989803150061 | FR3 Data Card |
| LAER- 989803150031 | FRS Infant/Child Key |
| LAER-198-00150 | FR3 AED Trainer |



Finger Tip Pulse Oximeter *Code ZM-MD300D*

The Finger Tip Pulse Oximeter combines monitor and sensor into one compact unit that provides accurate, reliable, SpO₂ rate and pulse rate (PR) measurements on patients ranging from paediatrics to adults. Ideal for use within any emergency, hospital or clinical setting. Powered by either two AAA rechargeable or alkaline batteries.



Heine Otoscope Mini 3000 *Code DEO-HMO*

The Heine Otoscope Mini 3000 is a compact pocket otoscope with direct illumination. This unique pocket size otoscope can only be used with the Mini 3000 handle system. Xenon halogen technology provides a concentrated white light for perfect illumination and a brilliant image. Three-times magnification and optimised casing surface for razor sharp images and minimal reflection. Swivelling viewing window built into instrument. Attachment clip with integrated on/off switch that switches off automatically when returned to the pocket.



Heine Ophthalmoscope Mini 3000 *Code DEO-HM*

The Heine Ophthalmoscope Mini 3000 is a high quality, pocket size ophthalmoscope with fixation star aperture and is ideal for clinics and pre-hospital use. Attachment clip with integrated on/off switch that switches off automatically when returned to the pocket. Enhanced XHL Xenon Halogen Technology provides a concentrated white light for perfect illumination and a brilliant image. Five different apertures offering a full function instrument including fixation star.



Sprague Rappaport Stethoscope *Code DES-SR*

The Sprague Rappaport Stethoscope offers superior acoustics for high, medium and low frequencies which is achieved by changing to the most appropriate of a selection of five interchangeable chest pieces. There are adult and paediatric diaphragms and three bells for accurate detection of high, middle and low frequency sounds in both children and adults. Key features include 56 cm tubing, adjustable binaural and accessory pouch containing two spare diaphragms, one pair of mushroom ear tips and one pair of silicon ear tips.



Littmann Classic II S.E. Stethoscope *Code DES-LC2*

Featuring a two-sided chest piece, the Littmann Classic II S.E. Stethoscope offers high acoustic sensitivity. A tunable diaphragm on one side augments the traditional bell function of the opposite side. Traditional bell combined with tunable diaphragm technology that allows you to conveniently alternate between low and high frequency sounds without turning over the chest piece. Single-lumen tubing in a variety of popular colours.



One Hand Sphygmomanometer *Code DESP-1HSR*

The One Hand Sphygmomanometer provides fully flexible reading positions and ease of handling as it is designed for the convenient use of both left and right hand operators. The air control permits exact release of air pressure. Key Features include sturdy velcro fastening, zipped leatherette case and push button valve which allows the user to deflate the sphygmomanometer gradually



Wall Mount Sphygmomanometer *Code DESP-W6*

This Wall Mount Sphygmomanometer has many essential and sought after features including a large easy to read 150 mm dial with a range from 0 - 300 mm Hg. 110° rotation for easy viewing and 2.4 m of coil tubing when extended.



First Aid Cabinets

Ferno offers a range of first aid cabinets that come in a variety of sizes ensuring the right fit for all your first aid and medical supplies. They are durable and most can be utilised as either a portable or wall mountable unit, with carry handles and single door entry. These attractive cabinets are finished in white powder coated steel.

| | Product | Length | Width | Depth |
|--------|---------------------------|--------|--------|--------|
| FACHC | First Aid Box Handy Chest | 250 mm | 160 mm | 80 mm |
| FACSF | First Aid Cabinet SF | 380 mm | 240 mm | 120 mm |
| FAC1W | First Aid Cabinet 1W | 380 mm | 200 mm | 120 mm |
| FAC2F | First Aid Cabinet 2F | 440 mm | 280 mm | 150 mm |
| FAC2W | First Aid Cabinet 2W | 440 mm | 280 mm | 150 mm |
| FACMWU | First Aid Cabinet MWU | 460 mm | 350 mm | 170 mm |
| FAC3F | First Aid Cabinet 3F | 590 mm | 400 mm | 170 mm |



ULM Classic Cases

The ULM Classic Case with its semi-variable interior compartments offer a wide range of compartment divisions for practically any requirement. Its versatility, combined with its unmatched ruggedness, durability and sheer good looks, make the ULM Classic Cases indispensable in any emergency.



Product Specifications

| Code | Description | Length | Width | Depth | Weight | Med Module |
|---------|-------------|---------|-------|-------|--------|------------|
| WM-8840 | ULM CASE 1 | 52.5 cm | 40 cm | 17 cm | 6.5 kg | 26 |
| WM-8730 | ULM CASE 2 | 52.5 cm | 40 cm | 20 cm | 6.7 kg | 33* |
| WM-8830 | ULM CASE 3 | 52.5 cm | 40 cm | 23 cm | 8.3 kg | 22 - 55 |

Flambeau Orange Medical Kits *Codes FAFPM1872, FAFPM2072, FAFPM2272 and FAFPM2273*

These highly durable medical kits are the perfect storage device, providing numerous compartments that are ideal for carrying a wide variety of medical supplies. Longevity is assured through the use of heavy duty copolymer lightweight material that is resistant to rust, dust, scratches and most common chemicals.

Product Specifications

| | Length | Width | Depth |
|--------|---------|---------|---------|
| PM1872 | 44.5 cm | 26 cm | 21.6 cm |
| PM2072 | 48.5 cm | 27.5 cm | 26 cm |
| PM2272 | 49.5 cm | 29 cm | 30 cm |
| PM2273 | 49.5 cm | 29 cm | 30 cm |



Ferno First Aid Kits *Code FAF1672G, FAF1772G, FAF1872G*

Ferno First Aid Boxes are purpose designed for first aid use and come standard with a locking feature, making the kits tamper-proof if desired. Metal hinges, over centre catch and a continuous tongue and groove seal make them dust and water resistant. Removable dividers in the internal trays allow you to customise your first aid contents and have a generous depth for greater storage and a smooth surface for easy cleaning. These features add to the quality and durability of the Ferno first aid box range.

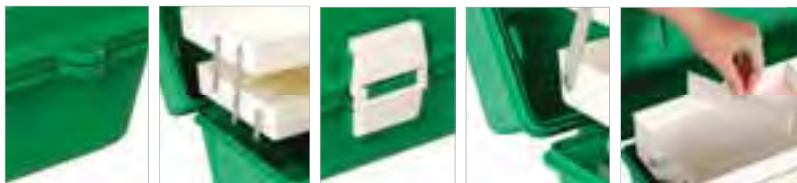

Ferno Compact First Aid Boxes *Codes FAF1272G FAF1472G*

The Ferno Compact First Aid Boxes are compact, lightweight and ideal for hiking, travelling or driving as they provide simple storage of your first aid equipment in the car, caravan or pack. The Ferno Compact Kits feature a full length hinge and snap lock lid that ensures a tight and secure close.



| | Length | Width | Depth | Carton Qty |
|----------|---------|---------|---------|------------|
| FAF1672G | 32 cm | 18.5 cm | 14 cm | 6 |
| FAF1772G | 42 cm | 22 cm | 18.5 cm | 4 |
| FAF1872G | 45 cm | 25 cm | 22 cm | 4 |
| FAF1272G | 25.5 cm | 11 cm | 4 cm | 24 |
| FAF1472G | 35.5 cm | 14 cm | 6 cm | 12 |

Thomas ALS Hard Case

Code THOM-TT423 ALS Complete (Grey), THOM-TT434 ALS Complete (Yellow)

The Thomas ALS Hard Case features a large removable padded drug case attached via heavy-duty magnets to the inside lid. The base of the case consists of a modular, foam divider system plus two removable fold outs featuring clear vinyl, colour-coded pockets. The base of the hard case can easily accommodate up to 3 L of IV solution and accessories, your IO device, as well as additional medications. This design allows for all base contents to be quickly and easily viewed. This combination allows several users to work out of the same case in multiple victim situations. Complete Thomas ALS Hard Case includes THOM-TT321 (removable drug case lid), THOM-TT742 (foam divided base) and Pelican 1550 Case.

Contents not included



Thomas Hard Case BLS

Code THOM-TT428 BLS Complete (Grey), THOM-TT430 BLS Complete (Yellow)

The Thomas BLS Hard Case features a removable padded lid that attaches via magnets to the inside of the lid. The lid section contains six colour-coded pockets that are designed to hold all of your BLS response equipment. The base of the Thomas BLS Hard Case consists of a modular, foam divider system plus 2 removable fold outs featuring clear vinyl, colour-coded pockets. This allows for all contents to be viewed when opening the case. The base and lid have similar space allocation so contents can be duplicated allowing two EMT's to work on separate patients simultaneously. Complete BLS Hard Case includes THOM-TT331 (BLS lid section), THOM-TT742 (foam divided base) and Pelican 1550 Case.



Contents not included

Thomas Airway Hard Case

Code THOM-TT432 Airway Complete (Grey), THOM-TT433 Airway Complete (Yellow)

The Thomas Airway Hard Case features a large removable intubation kit attached via magnets to the inside of the lid. This can be removed or remain secured to the lid and still be fully functional. The Intubation Kit is designed to hold an extensive array airway gear. The base of the case consists of a modular, foam divider system plus two removable fold outs featuring clear vinyl, colour-coded pockets. These are designed to accommodate multiple adult and paediatric BVM's. Complete Airway Hard Case includes THOM-TT341 (Removable intubation kit), THOM-TT742 (foam divided base) and Pelican 1550 Case.

Contents not included



Patient Handling

Immobilisation

Trauma / Airway Kits

Airway / Oxygen

Defibrillation / Diagnostic

BLS / ALS Packs & Cases

Vehicle Management

Casualty Room

Ferno Belt Holsters and Glove Pouches

Ferno manufactures and supplies a vast range of belt mounted holsters and pouches that are designed to securely hold instruments, torches, gloves and other commonly used tools of the trade. All items are made from heavy-duty nylon and guaranteed to perform.

- 1. FAPH800 Fits penlight or instrument (image not shown)
- 2. FAPH600 Fits penlight, instrument
- 3. FAPH100 Fits penlight, 3 instruments
- 4. FAPH200 Fits penlight, 3 instruments, stethoscope, glove pouch
- 5. FAPH275 Fits penlight, 3 instruments, window punch, stethoscope, glove pouch
- 6. FAPH400 Fits a resuscitation pocket mask
- 7. FAPGP100 Fits gloves (one pair)
- 8. FAPGP200 Fits gloves (five pair)
- 9. FAPGP250 Fits gloves plus resus shield



Saver Belt First Aid Kits 200GR and 300GR

Codes FAHAD 200GR and FAHAD 300GR

Carrying basic personal first aid requirements for work or outdoors is made easy with the Saver Belt First Aid Kits 200GR and 300GR. The kits are available in green.

200GR L 10 cm W 4 cm H 14 cm

300GR L 14 cm W 8 cm H 10 cm

FAHAD 200GR



FAHAD 300GR

Saver First Aid Kit 700GR

Code FAHAD-700GR

The Saver First Aid Kit 700GR is ideal for home, work and outdoor activities. Numerous inner pouches and elastic loops store and organise a good supply of first aid items.

This kit is available in green. L 22 cm W 8 cm H 15 cm



Saver First Aid Kit 800GR

Code FAHAD-800GR

The Saver First Aid Kit 800GR has numerous inner pouches and elastic loops, making it ideal for storing and organising a variety of first aid items. It is suitable for home, work and outdoor. This kit is available in green.

L 26 cm W 10 cm H 14 cm



Saver First Aid Hip Pack 1000GR

Code FAHAD-1000GR

The Saver First Aid Hip Pack 1000GR was originally designed to carry airway equipment for lifeguards, but can also be used to carry first-responder supplies or personal gear. This kit is available in green.

L 36 cm W 7 cm H 5 cm



Saver Rescue Trauma Hip Pack 900

Code FAHAD-900GR

The Saver Rescue Trauma Hip Pack 900 is widely used by search and rescue personnel and ski patrollers. It has a surprising amount of storage space and the waist belt straps tuck away when not in use.

Available in green. L 36 cm W 10 cm H 18 cm



Ferno 5117 Professional Trauma Mini-Kit

Code FAHAD-5117

This Ferno 5117 Professional Trauma Mini-Kit provides excellent storage space, enabling functional organisation of your essential trauma supplies. The bag utilises loops and durable mesh pockets to create an easily identifiable storage environment. The ferno 5117 is available in red and blue. L 34 cm W 8 cm H 24 cm



Ferno 5113 First-In Trauma Kit

Code FAHAD-5113

The Ferno 5113 is a great basic first response kit. The kit features an external pocket on the lid and a large, deep internal compartment that can be customised to fit all your essential first response gear. The kit comes with a removable base complete with moulded feet. This kit is compatible with Ferno Mini Kits. Available in red and blue. L 38 cm W 29 cm H 37 cm



Ferno Trauma Responder II Kit 5103

Code FAHAD-5103

The Ferno 5103 Trauma Responder Kit has a full opening compartment with elastic loops, a clear faced internal pouch and various internal segments that can be customised to suit the owner requirements. The kit also features a large external pocket with additional elastic loops that enhance the functionality of the kit. The 5103 features moulded feet on the bottom of the bag, providing extra protection and strength. Available in red and blue. L 43 cm W 23 cm H 39 cm



Ferno 5107 Professional Trauma Kit

Code FAHAD-5107

The Ferno 5107 Professional Trauma Kit is designed to accommodate all the supplies used by today's emergency professional. It has easy access to various external pockets that are configured with elastic loops and multiple internal pouches for first response supplies. The layout of the main internal body compartment can be customised quickly and is mini-kit compatible. A low profile back also keeps the kit close to the attendant minimising pressure on the spine when transporting a fully loaded kit. Supplied standard with an ergonomic, non slip shoulder strap plus a concealed backpack harness system. Available in red and blue. L 57 cm W 31 cm H 37 cm



Ferno 5108 Professional ALS Kit

Code FAHAD-5108

The Ferno 5108 Professional ALS Kit has the same features as the Ferno 5107 Professional Trauma Kit with the addition of four mini kits to provide the ultimate, compact advanced life support kit. Available in red and blue. L 57 cm W 31 cm H 37 cm

Kit Includes

- 1 x 5114 Medication Mini Kit
- 1 x 5115 Intubation Mini Kit
- 2 x 5116 Intravenous Mini Kits



Patient Handling

Immobilisation

Trauma / Airway Kits

Airway / Oxygen

Defibrillation / Diagnostic

BLS / ALS Packs & Cases

Vehicle Management

Casualty Room

Thomas Emergency Responder Pack TT800 Code THOM-TT800

The Thomas Emergency Responder Pack TT800 (ER) is specifically designed for initial care of critically ill or injured patients. The ladder frame of the pack can also serve as a splint when needed. This Kit includes eight interior pockets and three exterior pockets. This pack is available in orange. L 35 cm W 15 cm H 30 cm



Ferno Primary Response Kit R400 Code FAPR400

The Ferno Primary Response Kit R400 is an uncomplicated design that allows universal use. The internal layout of the Ferno Primary Response Kit is a combination of fixed, clear faced pockets and removable clear faced modules. A large external pocket further enhances the user's ability to customise the content layout. The well laid out design and bulky storage areas provide plenty of options for end users. The kit features a comfortable back harness and can also be carried by top mounted carry handle. This kit is available in red and blue. L 31 cm W 15 cm H 50 cm



Ferno Paramedic Rescue Backpack R300 Code FAPR300

The Ferno Paramedic Rescue Backpack is a large kit with spacious internal and external storage options. There is a total of 5 external pockets of varying size. The internal layout is a combination of fixed, clear faced pockets and removable clear faced modules. The long body, uncomplicated design and bulky area provides enough space to stock gear for the largest of scenarios. The kit features a comfortable, tuck-away back harness and can also be carried by top mounted carry handle. This kit is available in red and blue. L 31 cm W 15 cm - plus pockets H 60 cm



Traverse Kigali Patrol Pack Code TRAV20-0045

The Traverse Kigali organises and carries equipment for anyone responding away from the roadside, whether on foot, skis, ATV or mountain bike. Multiple pockets organise equipment for efficient access. A large sleeve with a retaining strap safely holds a 'C' size oxygen cylinder. Full suspension system with aluminum stays, padded shoulder strap and waist belt lets the pack ride comfortably all day, even when fully loaded. Built-in rain cover protects contents from snow, rain or other wet conditions. A removable (hook & loop) white medic cross for identification is included.

Contents not included



Thomas ALS & ALS Ultra Packs

The Thomas ALS Packs are designed to carry virtually all equipment and supplies needed by emergency medical teams to perform advanced cardiac and trauma life support. The colour-coded ABC configuration (Airway, Bleeding and Cardiac Medicine) helps responders with equipment location recall. In total, the packs include over 100 individual dividers, elastics and pouches. Includes adjustable backpack straps with chest connect strap. ALS Ultra Packs eliminate the stress and strain of transporting paramedic gear with the addition of an internal frame, wheels and a telescoping handle. The TT150 series is also available with capacity to hold an additional 400 L ÅeCÅf size cylinder and a larger exterior pocket to accommodate kit includes 2 x large exterior pockets, 3 x colour-coded airways pouches (intubation, airway, paediatric), 1 x soft drug box (holds over 50 separate drugs and vials), 3 x colour-coded IV pouches, 4 x exterior removable clear vinyl pockets



Contents not included

| | Length | Width | Height |
|------------------------------------|--------|---------|---------|
| THOM-TT100 Non Roller | 36 cm | 19 cm | 57.5 cm |
| THOM-TTR100 Roller | 36 cm | 20.5 cm | 57.5 cm |
| THOM-TT150 O2 Capacity, Non Roller | 36 cm | 18 cm | 57.5 cm |
| THOM-TTR150 O2 Capacity, Roller | 36 cm | 20.5 cm | 57.5 cm |

Ferno Airway Management/Oxygen Kit 5100 *Code FAHAD-5100*

The Ferno Airway Management/Oxygen Kit 5100 is very popular due to its ease of use and versatility. There are several external pockets that allow good storage options and oxygen can be accessed via the main compartment or through an external pocket. The internal compartment has room for a Australian 400 L 'C' size oxygen cylinder with enough space for additional oxygen or trauma gear. This kit includes one utility 5131 pouch and two 5134 utility pouches and is multi-kit compatible. This kit is conveniently fitted with a tuck-away harness system and is available in red and blue. L 58 cm W 24 cm H 33 cm



Ferno 5110 Professional Trauma/Air Management Kit II *Code FAHAD-5110*

The Ferno 5110 is a fully functional and convenient professional trauma and airway management kit which includes a tuck-away backpack harness system and the adjustable storage in the main compartment. Oxygen access is available through the end pocket and from the main compartment. The Ferno 5110 Professional Trauma/Air Management Kit II is compatible with Australian 400 L 'C' size oxygen cylinder. This kit is available in red and blue. L 64 cm W 28 cm H 38 cm



Saver 2140 O₂ Backpack Kit *Code FAHAD-2140*

The Saver 2140 O₂ Backpack Kit has numerous expandable mesh pouches and a main component lid with a full-size open pocket which is compatible with the 5117 Professional Trauma Mini-Kit. Two full length, zipped side pockets make the 2140 O₂ Backpack Kit very practical. This backpack conveniently holds an Australian 400 L 'C' size oxygen cylinder. This kit is available in red and blue. L 47 cm W 24 cm H 47 cm



Ferno 5120 Oxygen Carry Kit *Code FAHAD-5120*

This carry kit is a single piece design that is made with a squared aluminium frame to prevent the bag from rolling to one side at emergency scenes or during transportation. This carry kit easily hangs from stretchers and is padded for protection. The Ferno 5120 Oxygen Carry Kit comes with a double zip opening to provide easy access to the regulator. The kit will carry an Australian 400 L 'C' size oxygen cylinder. This kit is available in red and blue. L 55 cm W 16 cm H 22 cm



Patient Handling

Immobilisation

Trauma / Airway Kits

Airway / Oxygen

Defibrillation / Diagnostic

BLS / ALS Packs & Cases

Vehicle Management

Casualty Room

Ferno Responder Vest 5104 Code FAHAD-5104

The Ferno Responder Vest 5104 allows hands free transportation of first response and medical supplies. The outer front offers five easily accessed velcro closing, storage pockets as well as a radio and pen-flashlight holder. The inner front has two concealed pockets 24 cm x 21 cm. The rear of the vest has two large zip closure pockets as well as an area to attach reflective assignment tags. Adjustable straps ensure a comfortable fit for all body shapes. Front and back reflective strips ensure visibility in emergency situations. Available in red or blue



Ferno Responder II Vest 5105 Code FAHAD-5105

The Ferno Responder II Vest 5105 has various essential features that assist with emergency and rescue response situations. The outer front vest has 3 small top pockets and 2 large zipper pockets with multiple storage compartments within. There is also a radio and pen-flashlight holder. The inner front vest has two concealed pockets 24 cm x 21 cm. The rear of the vest has two large zip closure pockets as well as an area to attach reflective assignment tags. Adjustable straps ensure a comfortable fit for all body shapes. Front and back reflective strips ensure visibility in emergency situations. Available in red or blue



Ferno 5106 Responder II Mesh Vest Code FAHAD-5106

Made from breathable mesh material the Ferno Responder II Vest 5106 has various essential features that assist with emergency and rescue response situations. The outer front vest has 3 small top pockets and 2 large zipper pockets with multiple storage compartments within. There is also a radio and pen-flashlight holder. The rear of the vest has one zip closure pocket as well as an area to attach reflective assignment tags. Adjustable straps ensure a comfortable fit for all body shapes. Front and back reflective strips ensure visibility in emergency situations. Available in red or blue



same features of the 5105 without inside front concealed pockets and large rear pocket

CMC Rescue Radio Holster Harness Code CMC240027

This versatile holster enables a radio to be carried just about anywhere. The belt has loop slots for a conventional belt carry or loop through webbing for an over the shoulders carry. Dual velcro straps allow the radio holster to fit on the shoulder strap of a pack or full bodied harness. CMC's unique universal fit radio pocket is easy to adjust and securely holds a wide range of radio models while allowing easy access to all knobs, front mounted keypads and displays.



CMC Rescue Water Resistant Radio Harness

Code CMC240041 Harness and Aqua Pac Bag CMC421103 Aqua Pac Bag only

Decrease the risk of water damage to your radio due to inclement weather, over-spray from fire hoses or splashes. CMC's Water Radio Harness has been re-designed to take advantage of the watertight security of the Aqua Pac waterproof radio bag. The Aqua Pac bag attaches to a modified version of our CMC Rescue Radio Harness providing the same level of security and wearing comfort. Fits most radios up to 5 cm x 20 cm including antenna length.



Ferno 5115 Professional Intubation Mini Kit Code FAHAD-5115

The Ferno 5115 Professional Intubation Mini-Kit stores your intubation and airway supplies for quick access and ease of use. The removable internal pouch is ideal for miscellaneous supplies and contains a removable card for additional storage. This kit is available in red and navy blue.

L 33 cm W 8 cm H 24 cm



Ferno 5130 Intubation Ultra Mini-Kit Code FAHAD-5130

Designed to hold a variety of emergency airway supplies and accessories in an efficient compact layout that easily fits into larger kits. This kit is available navy blue only. L 14 cm W 5 cm H 29 cm



Ferno 5116 Professional Intravenous Mini Kit Code FAHAD-5116

The Ferno 5116 Professional Intravenous Mini-Kit allows storage and quick access to essential IV supplies. This mini-kit is easily stored inside larger kits and provides a billow pocket for small sharps containers. YKK zippers provide lockable security. Available in red and navy blue. L 11 cm W 9 cm H 23 cm



Thomas Insulated IV Pressure Infuser & Insulated IV Tubing

Code TTHOM-TT520 Insulated IV Pressure Infusion Bag THOM-TT521 - Insulated IV Tubing

Durable orange nylon with insulated padding and a clear plastic strip that provides good visibility of the fluid bag and fluid level. A built in hook allows the fluid bag to be replaced without removing the bag from the I.V. pole. A large squeeze bulb provides for fast inflation and a built in pressure indicator assists with correct IV flow and a air release vent allows quick deflation. 180 cm Insulated IV Tubing also available.



Ferno 5114 Professional Medication Mini Kit Code FAHAD-5114

The Ferno 5114 Professional Medication Mini-Kit offers a modern approach to organising drugs. The compact design enables storage within larger kits. The eight removable ampoule cards and lockable zipper ensures the safe storage of any drugs. This medication kit is available in red and blue. L 23 cm W 22 cm H 8 cm



Thomas Drug Kit TT300 Code THOM-TT300

The Thomas Drug Kit TT300 is able to hold more than 50 separate drug vials in addition to syringe boxes. It includes a dry erase board, pen and a separate narstretcherics section which can be locked. A padded drug bag and has two windows for printed material. Numerous clear vinyl support pockets and pouches that are ideal for carrying a wide variety of equipment and supplies and allow for rapid identification.

L 23 cm W 33 cm H 9 cm



Contents not included

Thomas Insulated Drug Case Code THOM-TT305

The small insulated drug case assists in protection medications from extreme weather conditions. Ideal for use in any kit the Thomas Insulated Drug Case also stores perfectly into the Thomas EMS Chillcore case which keeps your key refrigerated medications at the manufacturers recommended storage temperatures. L 23 cm W 10 cm H 4 cm



Contents not included

ACETECH Integrated Vehicle Intelligence System

What is ACETECH?

ACETECH is a fully integrated, performance monitoring and control system for vehicles. It provides you with powerful system wide, on-board intelligence - the operational data and insights to help you improve the efficiency and safety of your vehicles and staff, and to reduce your fleet's fuel and operating costs.

ACETECH can be installed together or individually to seamlessly merge with your vehicle's onboard electronics and communications. The system can be installed either at time of build or most ACETECH components can be retrofitted.

The ACETECH difference is in our integrated approach to vehicle systems - one company providing one complete solution. ACETECH eliminates the inconvenience of getting your vehicle based solutions from different providers. ACETECH does, however, work with other software.

ACETECH's integrated approach means you receive constant real time feeds of detailed data which you can use to take full control of asset placement in the field, enhance driver and occupant safety and reduce operational and fuel costs.

ACETECH provides a wide range of data for individual vehicles or your entire fleet including

- Vehicle status and location
- Battery management
- Crash prevention with event status and duration reporting
- Equipment tracking
- Engine status, idling and fuel consumption
- Real time alerts and detailed reporting

ACETECH FAQ?

Can I see an ROI from the ACETECH product line?

Yes. ACETECH replaces the features of several other manufacturers into one solution, bringing you excellent savings in both fuel costs and carbon emissions. The built-in safety program is world class in the way it allows you to better manage driving related risks.

Are the ACETECH components able to stand alone, or is it all or nothing?

The ACETECH system is both fully integrated and completely modular. While all four components together create a more robust vehicle management system, each individual component has the ability to stand alone according to your needs.

Does it matter what vehicle chassis or emergency vehicle manufacturer I use?

No. ACETECH will work on any chassis and we are working with vehicle converters to acquaint them with our product line. You are the end customer and can ask your builder to install the products you choose.

What kind of reports or data can I get?

If your system includes the AVI, you have a wealth of information at your fingertips. By logging on to our secure website, you can track vehicles, view your safety performance, determine idle time and estimate fuel costs, view response hotspots and much more. You can also schedule to receive real time alerts on critical performance issues regarding safety and vehicle performance.



The ACETECH™ Modules:

All ACETECH modules are available for new vehicle builds. AVI, ECO and AP Modules may be retrofitted on existing vehicles.

The ECU Module (Electronic Control Unit)



Provides CAN-Bus monitoring and customisable control of all vehicle electronics. This nerve centre eliminates countless relays, switches and control systems. It centralises functionality into one single programmable, reliable unit.



The AVI Module (Advanced Vehicle Informatics)



Combines GPS, OBDII and accelerometer data with real-time email alerts and web-based mapping. Reduce your risk and liability - track and correct fleet and vehicle issues and driver behaviour as it occurs. AVI Module also includes a full featured, web-based reporting interface.



The ECO-Run Module



Provides automated monitoring of system voltage and control of the vehicle's engine to reduce engine idling. Reduced idling lowers fuel consumption and carbon emissions which means increased savings and greener environmental results.



The AP Module (Asset Protection)



Provides RFID based tracking and security for all vehicle equipment assets. Control situations that can lead to the theft or loss of valuable equipment.



| Asset | Asset type | Status | Location |
|--------------------------------|--------------------|---------|----------------------------|
| General Bag # 1 (2144-1211) | General Bag # | Present | Mount St. East Div. Canada |
| Wound L&R (2144-1211) | Wound | Present | Mount St. East Div. Canada |
| Stretcher / Oxygen (2144-1211) | Stretcher / Oxygen | Present | Mount St. East Div. Canada |
| General Bag Type B (2144-1211) | General Bag # | Present | Mount St. East Div. Canada |
| ECR Type (2144-1211) | ECR Bag | Present | Mount St. East Div. Canada |
| ECR (2144-1211) | ECR | Present | Mount St. East Div. Canada |
| ECR Case (2144-1211) | ECR Case | Present | Mount St. East Div. Canada |
| ECR (2144-1211) | ECR # | Present | Mount St. East Div. Canada |

Medical/Instrument Trolleys (stainless steel)

The Stainless Steel Trolleys provide a clean and stylish storage solution. The stainless steel surface and construction ensures durability, resistance to corrosion and easy cleaning and disinfecting. Supplied with non-marking, 10 cm swivel wheels, with the option of varying number of drawers and drawer configurations.



CRT-SS2D-H

CRT-SSND-1

Product Specifications

| | Height | Width | Depth | Drawer |
|------------|--------|-------|-------|----------------------------|
| CRT-SS1D-1 | 90 cm | 50 cm | 50 cm | Single |
| CRT-SS1D-2 | 90 cm | 60 cm | 50 cm | Single |
| CRT-SS2D-H | 90 cm | 80 cm | 50 cm | Double drawer - horizontal |

| | Height | Width | Depth | Drawer |
|------------|--------|-------|-------|----------------------------------|
| CRT-SS2D-V | 90 cm | 50 cm | 50 cm | Double drawer - vertical |
| CRT-SS4D | 90 cm | 80 cm | 50 cm | 4 draw; 2 horizontal, 2 vertical |
| CRT-SS5D | 90 cm | 60 cm | 50 cm | 5 drawer - vertical |

Stainless Steel Pedal Bin *Codes SWPB*

The Stainless Steel Pedal Bin provides hygienic and convenient hands-free operation. The durable foot pedal mechanism and the non-slip, non-marking base ensures the longevity of this product. 12 Ltr capacity.



Step-Up Stools *Codes CRSS-SS (Single Step-Up Stool - chrome) and CRSS-ST (Double Step-Up Stool - chrome)*

Step-Up Stools are made with rigid tubular steel frame with a non slip vinyl top and a protected rubber edge. They provide simple assistance for stepping up onto a raised platform or bed area. Available in two sizes.

Product Specifications

| | Length | Depth | Height | SWL |
|-------------|--------|--------|--------|--------|
| Single Step | 455 mm | 265 mm | 200 mm | 140 kg |
| Double Step | 455 mm | 550 mm | 470 mm | 140 kg |



CRSS-SS



CRSS-ST

Ferno Mobile Privacy Screen *Codes CRP-3M*

The Ferno Mobile Privacy Screen is a lightweight, stable and secure screen. Each panel is made with lightweight vinyl that is heat sealed and easy to clean. The rigid frame is constructed from anodised aluminium for easy manoeuvrability and the legs and castors are removable so the unit can be packed flat for storage or freight.

Product Specifications

| | Width | Height |
|----------|--------|--------|
| Folded | 66 cm | 158 cm |
| Extended | 192 cm | 158 cm |



Magnifying Lamp *Codes CRL-ML*

Magnifying lamps produce high quality, shadowless lighting for intricate examination tasks. 1.75 x magnification through a 120 mm diameter three dioptré lens 22 watt circular fluorescent tube produces 1250 lumens of shadowless 'daylight' illumination. Angle poise spring balanced adjustable arm with a full extension of 1150 mm. Comes complete with a table clamp.

Mounting Options

- CRL-MWB: Wall mount (plastic moulded)
- CRL-D: Desk clamp (plastic moulded)
- CRL-T-S: Mobile base



Casualty Couch Code CRC-C (standard), CRC-CHD (heavy duty)

Casualty or examination couches are a basic essential of the consulting and treatment setting. Supplied unassembled, the couch is easy to assemble with just 4 bolts, tools provided. Weight capacity 175 kg. Also available in heavy duty version with 250 kg SWL.

Key Features

- Sturdy 32 mm tubular steel frame
- Powder-coated finish
- Vinyl covered 40 mm foam padding
- Adjustable head rest
- Compatible with Casualty Couch accessories
- Dimensions: L 1820 mm, W 610 mm, H 780 mm



Mobile Casualty Couch Code CRC-CM

Patients and practitioners alike continue to appreciate the comfort, stability, strength and aesthetic design of this mobile couch. It provides many of the features of the standard Casualty Couch with the additional and often essential feature of mobility.

Key Features

- Sturdy chrome finish tubular frame
- 125 mm rubber castors, 2 with locks
- Fixed 75 mm thick foam padded top
- Adjustable head rest
- Compatible with Casualty Couch accessories.
- Dimensions: L 1820 mm, W 610 mm, H 780 mm



Accessories shown in image sold separately. See below

Casualty Couch Accessories

Safety Rails Pair Code CRC-CMR

Available in a chrome finish these safety rails feature two upright locking positions as well as the down position. Easy to operate and bolt straight onto the Mobile Casualty Couch.

Wire Basket Code CRC-CWB

The removable wire basket fits the Standard Casualty Couch or Mobile Couch. It features a strong construction and powder-coated finish.



IV Poles & Accessory Clamp

Codes CRC-CRIS (Stainless Steel) and CRC-CI (chrome plated mild steel), Code CRC-CIC (Accessory Clamp)

These IV poles conveniently clamp on to the Casualty Couch and made from 12 mm rod with a double IV hook. Accessory clamps are required for fitting the IV pole to the couch.



Airlite Wheelchair Code CRW-FL-0211A

The Airlite Wheelchair is a low cost, aluminium chair that does not sacrifice practical application or convenience. The swing away removable footrest and fold down back rest provide versatility in use and storage. It also features nylon upholstery, removable wheels and retractable or removable footrests. Weight 12.3 kg. Weight capacity 115 kg.



Laerdal Resusci Anne Series

The Resusci Anne Basic, SkillGuide and SkillReporter manikins offer optimal realism so students can quickly sharpen their skills to perform quality adult CPR. The SkillGuide performance indicator provides feedback on inflation volume, compression depth, hand position and inflation rates. The SkillReporter provides additional printed reports on ventilation and compression compliance. The Resusci Anne's modular construction will allow the addition of optional first aid or rescue limbs to integrate first aid, trauma, and extrication to the training.

Key Features

- Natural obstruction of the airway
- Head tilt/chin lift and jaw thrust
- Occluded airway with hyperextension
- Realistic resistance for chest compression
- Anatomically correct landmarks & sternal notch
- Carotid pulse simulation
- Disposable non-rebreathing airways
- Removable/reusable faces
- Articulating arms, legs & head (full body version)



Resusci Anne CPR Manikin Includes:

Torso/Full-Body Manikin, 4 Decorated Resusci Manikin Faces, 3 Disposable Manikin Airways, Carrying Case or Soft Pack, Track Suit (Full-Body Models) or Jacket (Torso Models), Directions for Use and Virkon Rapid Pack. SkillGuide Models include the SkillGuide unit. SkillReporter Models include SkillReporter unit and 1 roll of printed paper.



SkillGuide performance indicator provides feedback on inflation volume, compression depth, hand position and inflation rates.



SkillReporter provides additional printed reports on ventilation and compression compliance.

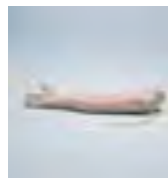

IV training arms are lifelike with complete venous systems for training of peripheral IV therapy skills.



Airway Trainer simulates real world complications when practicing intubation, ventilation and suction techniques.

Supply Schedule

| | | | |
|---------------|--|---------------|--|
| LAER-31000515 | Torso Basic with Hard Case | LAER-316000 | Airway Trainer Update Kit (Basic & SkillGuide) |
| LAER-31000615 | Torso Basic with Soft Pack | LAER-316200 | Airway Trainer Update Kit (SkillReporter) |
| LAER-31003515 | Full-Body Basic with Hard Case | LAER-312025 | IV Arm |
| LAER-31001515 | Torso SkillGuide with Hard Case | LAER-152250 | Airways (pkt 24) |
| LAER-31001615 | Torso SkillGuide with Soft Pack | LAER-310210 | Faces (pkt 6) |
| LAER-31004515 | Full-Body SkillGuide with Hard Case | LAER-15120103 | Face shields (6 rolls of 36) |
| LAER-31002115 | Torso SkillReporter with Hard Case | | |
| LAER-31005515 | Full-Body SkillReporter with Hard Case | | |

Laerdal Multi-Venous IV Training Arm Kit Code LAER-270-00001

Laerdal's IV training arms are lifelike reproductions with complete venous systems for training of peripheral intravenous therapy skills and procedures including IV cannulation, infusion, IV bolus, IV push, Site care & maintenance.

Each kit includes: Arm, Replacement Skin & Multi-Vein System, Simulated Blood, Blood Bag with Tubing and Connector, Clamp & Hook, 5 Syringes, Airway Lube, Carry Case and Directions for Use.



Laerdal Airway Management Trainer Code LAER-2500033

The Laerdal Airway Management Trainer's lifelike upper torso and head simulates real world complications when practicing a variety of intubation, ventilation and suction techniques. Includes Manikin on board, Airway Demonstration Model, Cleaning Kit, Airway Lube, Carry Case and Directions for use.



Laerdal Resusci Junior Basic and Skillguide

The Laerdal Resusci Junior manikin offers realistic, high-quality child CPR education. It has full-body construction and use of an optional Skillguide performance indicator so that students can quickly sharpen their skills in performing child CPR. The Laerdal Resusci Junior comes with a durable hard case.

Key Features

- Natural obstruction of the airway
- Head tilt/chin lift and jaw thrust
- Realistic chest rise
- Realistic resistance for chest compressions
- Anatomically correct landmarks and sternal notch
- Life-like size and weight of a five year old child
- Bilateral carotid pulse simulation
- Disposable non-rebreathing airways
- Optional SkillGuide CPR performance indicator



Resusci Junior Manikin Includes:

Paediatric Manikin, Hard Plastic Carry Case (except where noted), Training Mat, Track Suit, 4 Junior Faces, 4 Junior Airways, Virkon Rapid Pack and Directions for Use. Model listed as "SkillGuide" includes the SkillGuide unit. Model listed as Water Rescue includes the Water Rescue Update Kit accessory.

Supply Schedule

| | | | |
|---------------|----------------------------------|---------------|------------------------------|
| LAER-18001015 | Resusci Junior | LAER-183010 | Faces (pkt 6) |
| LAER-18001115 | Resusci Junior with SkillGuide | LAER-183210 | Airways (pkt 25) |
| LAER-18001215 | Resusci Junior with Water Rescue | LAER-183211 | Airways (pkt 100) |
| | | LAER-15120103 | Face Shields (6 rolls of 36) |

Laerdal Resusci Baby Basic and Skillguide

The Laerdal Resusci Baby manikin offers realism and quality to infant CPR education. Its full-body construction and use of the optional Skillguide performance indicator enables students to quickly sharpen their skills in performing infant CPR. The Laerdal Resusci Baby Basic and Skillguide comes supplied with a carry case.

Key Features

- Natural obstruction of the airway
- Head tilt/chin lift and jaw thrust
- Occluded airway with hyperextension
- Realistic chest rise and resistance
- Anatomically correct landmarks and sternal notch
- Articulating arms, legs and head
- Brachial pulse simulation
- Disposable non-rebreathing airways
- Optional Skill Guide CPR performance indicator



Resusci Baby Manikin Includes:

Infant Manikin, Hard Plastic Carry Case, 3 Baby Faces, 6 Baby Airways, Virkon Rapid Pack, Pulse Bulb, Tubing, and Directions for Use. Model listed as "SkillGuide" includes the SkillGuide unit.

Supply Schedule

| | | | |
|---------------|---------------------------|---------------|------------------------------|
| LAER-14001015 | Resusci Baby | LAER-143600 | Faces (pkt 6) |
| LAER-14001115 | Resusci Baby w/SkillGuide | LAER-143601 | Faces (pkt 36) |
| LAER-143700 | Airways (pkt 24) | LAER-15120103 | Face Shields (6 rolls of 36) |
| LAER-143701 | Airways (pkt 96) | CPRLA-FS36 | Face Shields (1 roll of 36) |

Laerdal Little Family

Developed to provide affordable, effective, realistic CPR training without compromising realism or quality. The lightweight design and convenient packaging makes these inexpensive manikins easy to transport and the durable construction provides affordable long-term use

Key Features

- Oral and nasal passages for realistic nose pinch
- Natural obstruction of the airway
- Head tilt/chin lift and jaw thrust
- Realistic airway function
- Anatomically correct landmarks and sternal notch
- Audible feedback reinforces correct compression depth
- Realistic chest compression resistance
- Economical disposable airways
- Removable and reusable faces
- Foreign-body airway obstruction feature (Baby Anne only)



Little Anne Manikin Includes:

1 Manikin, Soft Pack/Training Mat, 2 Resusci Manikin Faces, 2 Little Anne Airways, Virkon Rapid Pack and Directions for Use.



Baby Anne Manikin Includes:

1 Manikin, Soft Pack, 6 Airways, 10 Foreign Body Practice Objects and Directions for Use.



Little Junior Manikin

Includes:

1 Manikin, Soft Pack/ Training Mat, 2 Junior Faces, 2 Junior Airways, Virkon Rapid Pack and Directions for Use.



Little Family Pack Includes:

Little Family Pack Includes: 1 each Manikin, 2 Little Anne & Junior Airways, 6 Baby Anne Airways, 6 rolls of 36 Face Shields and Directions for Use.

Supply Schedule

LAER-02002015 Little Anne Light Skin
 LAER-02002415 Little Anne Light Skin 4-Pack
 LAER-02002515 Little Anne Dark Skin
 LAER-02002915 Little Anne Dark Skin 4-Pack
 LAER-18002015 Little Junior Light Skin
 LAER-18002515 Little Junior Dark Skin
 LAER-18002215 Little Junior Light Skin 4-Pack
 LAER-18002715 Little Junior 4-Pack Dark Skin

LAER-050000 Baby Anne Light Skin
 LAER-050002 Baby Anne Dark Skin
 LAER-050010 Baby Anne Light Skin 4-Pack
 LAER-050012 Baby Anne 4-Pack Dark Skin

LAER-020300 Airways (pkt 24)
 LAER-020301 Airways (pkt 96)
 LAER-310210 Faces Light Skin (pkt 6)
 LAER-310215 Faces Dark Skin (pkt 6)
 LAER-15120103 Face Shields (6 rolls of 36)
 LAER-183010 Faces Light Skin (pkt 6)
 LAER-183015 Faces Dark Skin (pkt 6)
 LAER-183210 Airways (pkt 25)
 LAER-183211 Airways (pkt 100)

LAER-050100 Airways (pkt 24)
 LAER-050200 Faces Light Skin (pkt 6)
 LAER-050202 Faces, Dark Skin (pkt 6)
 LAER-050300 Foreign Objects (pkt 10)

Simulaids Rescue Manikins

The official manikins of the Firefighter Combat Challenge, Simulaid's manikins are the best way to maintain the reality of rescue training without using a live subject. Fully articulated, Rescue Randy can be positioned in every conceivable situation. The head and body are built of dense, flexible, life-like vinyl that is rugged and waterproof. The 1905 kg force breaking strength stainless-steel cables are coated. Rescue Randy has been designed to be a realistic 183 cm (6 ft) tall, 75 kg body-size manikin. Jennifer Juvenile is 121 cm (4 ft) tall; equivalent to a 7 or 8-year-old child. The Water Rescue Randy was developed for YMCA water safety courses and allows adjustment to its buoyancy by adding weight to the abdomen. It weighs 18 kg on dry land but will sink with about 4.5 kg added weight. I.A.F.F. Rescue Randy has additional reinforcement for even greater durability. Note: Only the Water Rescue Manikin should be used in the water.



Product Specifications

| | Model | Height | Weight |
|-----------|---|--------|--------|
| CMC781338 | Rescue Randy | 165 cm | 25 kg |
| CMC781335 | Rescue Randy | 165 cm | 48 kg |
| CMC781344 | Rescue Randy Combat Challenge | 183 cm | 66 kg |
| CMC781345 | Rescue Randy Combat Challenge | 183 cm | 75 kg |
| CMC781475 | I.A.F.F. Rescue Randy | 183 cm | 75 kg |
| CMC781355 | Jennifer Juvenile | 121 cm | 7 kg |
| CMC781326 | Water Rescue Manikin | - | 18 kg |
| CMC781373 | Nylon Storage Bag 7, 25, 48kg Simulaids | | |
| CMC782094 | Nylon Storage Bag 66 or 75kg Simulaids | | |

Ferno F.R.E.D. Code FRED-ADULT-UF (unfilled) and FRED-CHILD-UF (unfilled)

The FRED (Ferno Rescue Emergency Device) is a low-cost rescue device that has been put through some serious testing and now incorporates the following features.

Key Features

- Heavy-duty rip-stop UV resistant PVC material
- Carry straps on shoulder and above knees
- Label for identifying FRED weight
- Velcro on abdomen section and hands to keep hands secured
- Reinforced head with some movement and flexibility
- Reinforced foot heels for dragging
- For shipping purposes, FRED is only available unfilled
- Recommended weight for Adult 55 kgs and Child 25 kgs



Thomas MCI Man and Thomas MCI Ped

The Thomas MCI Man and Thomas MCI Ped are a smart, efficient way to help conduct your MCI training and drills. These durable, inflatable training manikins save money and time while significantly reducing the liability of conducting mass casualty incident drills.

Key Features

- Clear chest pocket to provide scenario information
- Durable plastic material resists punctures
- Quick inflation / deflation
- Sandbags in feet keep manikins in place
- Grommets on shoulders allow for tie-down
- Store easily
- Economical and reusable.



Lifetec General Purpose Dummy

The Lifetec General Purpose dummies are suitable for common dry rescue scenarios such as height, confined space, USAR, RTA and general handling exercises. They are weighted to produce an anatomically correct weight distribution and the feel of an unconscious patient. These dummies are tough enough to be buried under concrete slabs, trees or have motor vehicles laid upon them to present realistic scenarios for rescuers. Machine washable, protective overalls keep the dummy clean, and greatly increase the lifespan of the dummy. For additional protection, all training dummies of 20 kg and over are supplied complete with gum boots. Also available with camouflage overalls.



Product Specifications

| | Description | Height | Weight |
|----------|------------------|--------|--------|
| LT-RL5 | Baby training | 0.69 m | 5 kg |
| LT-RL10 | Toddler training | 0.87 m | 10 kg |
| LT-RL20 | Youth training | 1.30 m | 20 kg |
| LT-RL30 | Light adult | 1.83 m | 30 kg |
| LT-RL50 | Standard adult | 1.83 m | 50 kg |
| LT-RL70 | Heavy adult | 1.83 m | 70 kg |
| LT-RL100 | Very heavy adult | 1.83 m | 100 kg |



Lifetec Water Rescue Dummy

The Lifetec Water Rescue Dummy perfectly simulates an unconscious casualty in water. They will float at an angle of approximately 45 degrees with just the head and shoulders visible. The overalls supplied have integral pockets that enable the user to add buoyancy or weight to the dummy. Additional use of a heavy-duty nylon mesh and closed cell foam allows water to flood out of the dummy as it is being recovered. The Lifetec Water Rescue Dummies can now be supplied in two models: 'man overboard' or 'search and rescue'. The man overboard dummy is supplied with bright orange overalls and reflective tape on the headband. The search and rescue model is supplied with black overalls with no reflective tape.



Product Specifications

| | Description | Height | Weight |
|-------------|--------------------------------------|--------|--------|
| LT-RLWRMO | Water Rescue - Adult Man Overboard | 1.83 m | 40 kg |
| LT-RLWRSR | Water Rescue - Adult Search & Rescue | 1.83 m | 40 kg |
| LT-RLWRMO20 | Water Rescue - Youth Man Overboard | 1.30 m | 20 kg |
| LT-RLWRSR20 | Water Rescue - Youth Search & Rescue | 1.30 m | 20 kg |



Lifetec Flame Retardant Dummy

The Flame Retardant Dummy is designed for high temperature snatch rescue scenarios with real flames and the chance of a flash-over. They are weighted to produce an anatomically correct weight distribution and the feel of an unconscious patient. The higher specification, flame retardant dummies demonstrate a good balance between temperature and abrasion resistance. The Flame Retardant dummy is similar to the general purpose dummy, but incorporates glass fibre for the outer carcass stitched with PTFE coated glass thread. The protective overalls are made using Kermel flame retardant fabric which provides excellent heat and abrasion resistance and each dummy is fitted with heat resistant fire-fighters safety boots. The dummies will easily withstand temperatures of 200-250° C and only starts to fail at temperatures in excess of 400° C. Flash-over temps greater than 1000° C are withstood by the dummy for short periods.

Product Specifications

| | Description | Height | Weight |
|-----------|----------------------------------|--------|--------|
| LT-RLFR30 | Flame Retardant - light adult | 1.83 m | 30 kg |
| LT-RLFR50 | Flame Retardant - standard adult | 1.83 m | 50 kg |



Lifetec Multi-Trauma Rescue Training Dummy

The Lifetec Multi-Trauma Rescue Dummy is a general purpose rugged rescue dummy that can simulate an impaled torso, suspected neck injury and amputated arm or leg and allows the fitting of an extrication collar. The hole on the left of the torso allows a paling or a spike that is firmly held in place. The right arm and right leg are fully detachable to simulate an amputation, or by partially releasing the locking straps the limb can be weakly attached and will fall off. The dummy is supplied complete with sturdy gum boots that protect the legs if the dummy is dragged along the ground. The Multi-Trauma Rescue Dummy is tough enough to allow a vehicle or heavy girder to be laid on it without damage.



Product Specifications

| | Description | Height | Weight |
|-----------|--|--------|--------|
| LT-RLMT30 | Lifetec Multi-Trauma Manikin, Light Adult | 1.83 m | 30 kg |
| LT-RLMT50 | Lifetec Multi-Trauma Manikin, Standard Adult | 1.83 m | 50 kg |



Lifetec HazMat Dummy

The standard general purpose dummy is ideal for all the general rescue scenarios, but when you need to practice a rescue scenario where the dummy needs to be doused in water such as a chemical spillage, or lay for long periods in a constantly wet storm water drain, foul water or wet cave rescue then the HazMat Dummy is the one you need. The Lifetec HazMat Dummy has a carcass of nylon reinforced PVC which will withstand continuous wet conditions. It is supplied with a polyurethane coated polyester overall. At the end of the rescue exercise hose the dummy down with fresh water and hang up to dry.

Product Specifications

| | Description | Height | Weight |
|-----------|----------------|--------|--------|
| LT-RLHM30 | Light Adult | 1.83 m | 30 kg |
| LT-RLHM50 | Standard Adult | 1.83 m | 50 kg |
| LT-RLHM70 | Heavy Adult | 1.83 m | 70 kg |



Lifetec Bariatric Dummy

The Lifetec Bariatric Dummy provides rescue teams with a realistic alternative for bariatric retrieval and enable realistic training to take place. The Bariatric dummy is based around a 100 kg general purpose dummy with a further 5 layers over the top, these being a mixture of the weighted layers and foam cushioning that enables the weight to slide from side to side. Supplied complete with a carrying sheet to assist in carrying and positioning the dummy.



Product Specifications

| | Description | Height | Weight |
|------------|-------------|--------|--------|
| LT-RLLG180 | Obese Adult | 1.8 m | 180 kg |



Rescue

When you're concentrating on rescuing a patient you rely on your equipment to perform 100 percent.

Ferno's extensive range of rescue equipment has you covered for every conceivable scenario and patient size — from babies to bariatric.

Ferno-made rescue equipment is designed with the end-user in mind and manufactured to stringent quality standards.

Engineered to be strong yet remain light-weight, the many thoughtful features built into our designs makes our gear user-friendly, intuitive and efficient to use.

A wide range of accessories extend the versatility of Ferno's rescue equipment and includes flotation collars, head shields, pillows and blankets, IV poles, handles, straps and wheels — basically all those extras that enhances safety and comfort in the field for you and your patient.



Traverse Titan Basket Stretcher (Stainless Steel)

The Titan Series Basket Stretcher is specifically designed to perform in a technical rescue environment. Its superior design provides a user-friendly platform from which to work. The unique StratLoad attachment points make it quick, easy and safer to secure the litter bridle and protects the karabiners from wall and rock faces. The 25 mm reinforced, top rail provide reassuring strength in vertical haul or lowering operations as well as being easy to handle during extended periods. Durathene netting allows water and air to easily pass through the patient compartment, yet the small holes keep from snagging debris as easily. Tested to and beyond a 1136 kg (11 kN) static load test threshold, users can be ultimately confident in their use of the Traverse Titan Basket Stretchers.

The Titan32 is made specifically to deal with larger patients and provides extra room where the size of the patient dictates a different approach in handling.

Common Key Features

- Tested to and beyond a 1136 kg (11 kN) static threshold
- StratLoad Attachment Points for secure bridle connection
- Reinforced 25 mm top rail
- Supplied with 4 steel double bar restraints
- Durathene netting allows water and air flow
- Compatible with any Ferno backboard
- Tapered feature allows easier access in confined areas
- Moulded, high density polyethylene back support

Split Version Key Features

- Interlocked, pinless, bottom hinges
- Integral top rail with threaded collets
- Completely solid connection between the two parts
- Assemble or un-assemble in approximately 15 seconds
- Engineered to nest together for storage when split

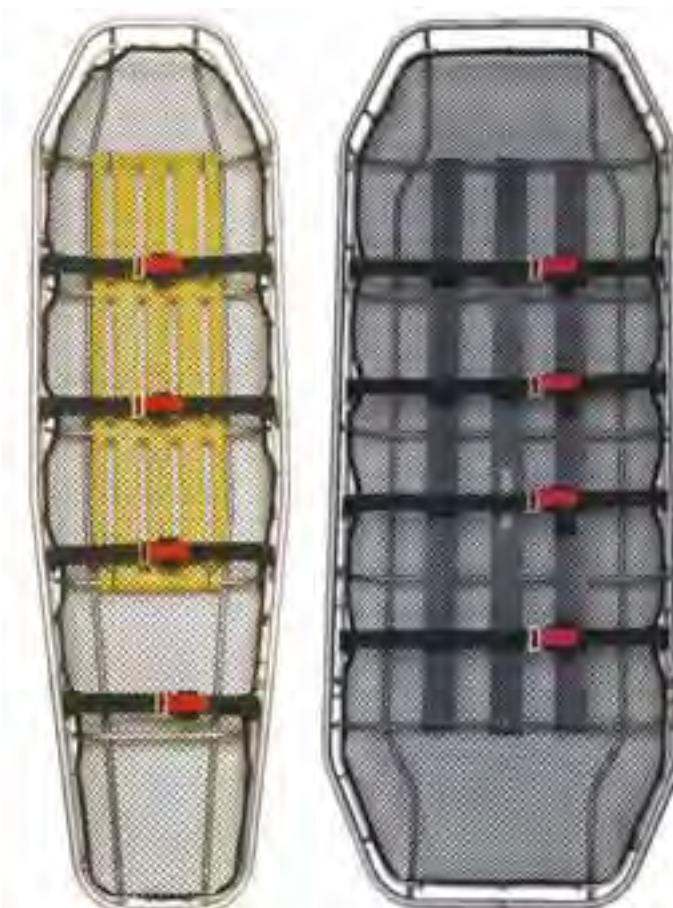

FWETBT (One-Piece)

Titan 32 for larger patients



FWETBT-SP (Split Version)



Patented 'Locsafe' triple safety system. Interlocking latching teeth. Integral threaded rail collars. Collar lock button

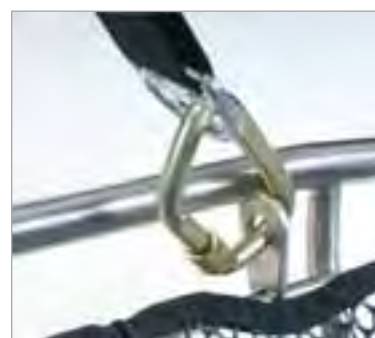

Stratload attachment point

Product Specifications

| | Code | Length | Width | Height | Weight | Load Rating |
|---------------------------|-----------|--------|-------|--------|---------|-----------------|
| Stainless Steel One-piece | FWETBT | 211 cm | 58 cm | 18 cm | 14 kg | 1136 kg (11 kN) |
| Stainless Steel Split | FWETB-SP | 211 cm | 58 cm | 18 cm | 16.3 kg | 1136 kg (11 kN) |
| Stainless Steel 32 | FWETBT-32 | 211 cm | 81cm | 18 cm | 19.2 kg | 1136 kg (11 kN) |

Traverse Advantage Basket Stretcher Code FWETAB

The Advantage Basket Stretcher is a complete redesign from any other plastic style basket stretcher available today. The fully-internal stainless steel frame provides a 1136 kg (11 kN) strength rating while giving a single-plane sliding surface on the bottom. The outer High Density Polyethylene (HDPE) shell is attached to the top tube, allowing the secondary rail to be completely exposed to provide full options for tying in your patient for the most technical rescue.

Generous cut-out sections in the shell provide loads of exposed top rail for handling, and the 22 mm tubing allows for a more comfortable grip. The patient pad is made of closed-cell foam that will not allow fluids to soak into, and is able to withstand even the harshest cleaning agents. It is glued in such a manner that allows it to be removed and replaced if required. Standard on the Advantage Basket Stretcher is the patented StratLoad attachment points.

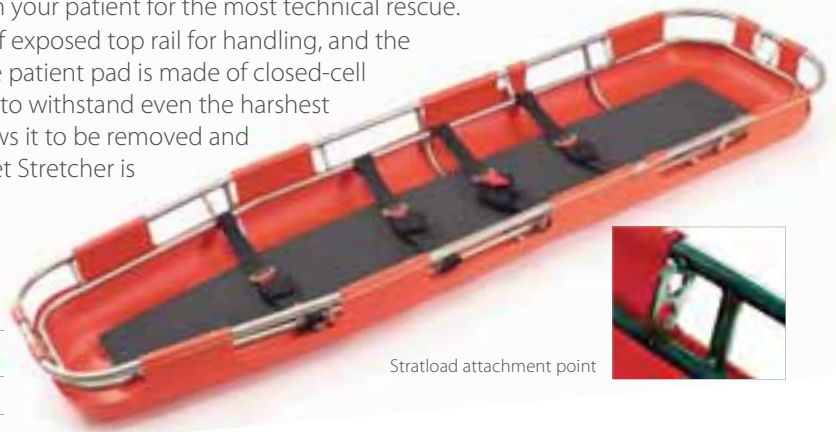

Stratload attachment point

Product Specifications

| Length | Width | Height | Weight | Load Rating |
|--------|-------|--------|--------|-----------------|
| 216 cm | 60 cm | 19 cm | 13 kg | 1136 kg (11 kN) |

Spartan Split Basket

The Traverse Spartan heavy duty split apart HDPE shell basket designed for technical rescue. A fully exposed top rail allows multiple rescuers the ability to grasp wherever is best suited to the load, and large access areas allow big or gloved hands into the hand holes. A full length plastic shell with recessed exterior stainless steel tubing facilitates dragging over rough or craggy terrain. A foam patient pad is supplied patient comfort on long carry outs. The Traverse Spartan has a 1136 kg (11 kN) load limit and is supplied with the Stratload harness connection feature and Locsafe triple safety system.

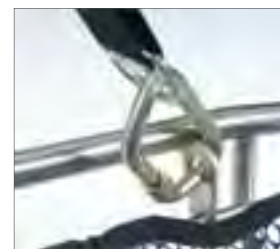

Stratload attachment point

Product Specifications

| Length | Width | Height | Weight | Load Rating |
|--------|-------|--------|--------|-----------------|
| 220 cm | 63 cm | 17 cm | 15 kg | 1136 kg (11 kN) |



Patented 'Locsafe' triple safety system.



The absolute safest baskets on the market



Traverse Rescue two piece baskets have a patented 'Locsafe' triple safety system to make sure they stay connected. Firstly, interlocking latching system at the bottom of our baskets ensure a safe connection. Secondly, locking collars on each side securely join the outer rails. Thirdly, once the collar has been fully turned and locked, a lock button is exposed preventing the collars from unthreading. This is important because the collars cannot inadvertently undo itself when rubbing against a wall or cliff face. With our patented "Locsafe" system, this is prevented.



We think these features make Traverse two piece baskets, the absolute safest on the market

Traverse Titan Basket Stretcher (Titanium)

For the ultimate in strength to weight ratio, the Titan Titanium Basket Stretcher sets a new standard for rescue litters. It is made from ASTM Grade 2 titanium tubing making it less than half the weight of the Titan Stainless Steel stretchers making them ideally suited for applications where weight saving is your ultimate goal.

Common Key Features

- Tested to and beyond a 1136 kg (11 kN) static threshold
- StratLoad Attachment Points for secure bridle connection
- Reinforced 25 mm top rail
- Supplied with four steel double bar restraints
- Durathene netting allows water and air flow
- Compatible with any Ferno backboard
- Tapered feature allows easier access in confined areas
- Moulded, high density polyethylene back support

Split Version Key Features

- Interlocked, pinless, bottom hinges
- Integral top rail with threaded collets
- Completely solid connection between the two parts
- Assemble or un-assemble in approximately 15 seconds
- Engineered to nest together for storage when split



Product Specifications

| | Code Standard | Code ANT | Length | Width | Height | Weight | Load Rating |
|--------------------|---------------|----------|--------|-------|--------|--------|-----------------|
| Titanium One-piece | FWETTI | TBA | 211 cm | 58 cm | 18 cm | 6.1 kg | 1136 kg (11 kN) |
| Titanium Split | FWETTI-SP | TBA | 211 cm | 58 cm | 18 cm | 7.6 kg | 1136 kg (11 kN) |

Ferno 71 and Ferno 71-S Basket Stretcher

The Ferno 71 Basket Stretcher is constructed of a high density polyethylene shell supported by a permanently attached heavy-duty aluminium frame. Moulded-in runners and handholds make it easy to handle. This basket stretcher is chemical, UV, rust and corrosion resistant. An easily replaceable mattress is attached inside the stretcher for patient comfort. Supplied standard with four two-piece quick release patient restraints. The Ferno 71-S two-piece Basket Stretcher has the same features as the one-piece Ferno 71 Basket Stretcher but separates in half for compact storage or backpacking to a rescue site.

Key Features

- Brass grommets strategically located for quick use with the Ferno Adjustable Lifting Bridles.
- Moulded runners and handholds

Additional Features of split 71-S

- Separates for compact storage or backpacking to rescue site
- Stretcher halves store nested together
- Stretcher is quickly assembled and secured with pins



| | Code | Length | Width | Height | Weight | Load Limit |
|-----------|--------|--------|-------|--------|--------|------------|
| One-piece | FWE71 | 218 cm | 61 cm | 19cm | 10 kg | 272 kg |
| Two-piece | FWE71S | 218 cm | 61 cm | 19cm | 10 kg | 272 kg |

Traverse Gazelle Basket Stretcher Code FWETBG (standard) and FWETBGCS (confined space)

The Traverse Gazelle Basket Stretcher is a light, disaster response stretcher that is ideal for industrial rescue organisations. Its steel frame geometry and construction with durathene netting provides impressive strength along with durability and versatility. The tubular runner rails that extend the full length provide a durable base that minimises stretcher damage. Flat carbon steel patient supports bars extend down the length of the stretcher. The Traverse Gazelle represents a cost effective alternative that will meet the needs of infrequent stretcher users.

Key Features

- Tested to and beyond a 408 kg static threshold
- Supplied with three steel double bar restraints
- Durathene netting allows water and air flow
- Black powder coated all carbon steel frame construction
- Tubular bottom runner rails
- Compatible with any Ferno backboard
- Tapered feature allows easier access in confined areas
- Cost effective

Product Specifications

| | Length | Width | Weight | Load Rating |
|----------------|--------|-------|--------|-------------|
| standard | 211 cm | 62 cm | 13 kg | 408 kg |
| confined space | 211 cm | 46 cm | 12 kg | 408 kg |



Saver Basket Stretcher Code FWE71SAVER FWE71SPSAVER

Ideally suited to moving or rescuing an injured person from a building site, quarry, mine or mountain. The Saver Basket Stretcher can be dragged, carried or hand lifted across rough or muddy terrain without affecting the patient's wellbeing. Providing full body protection, it comes complete with four movable patient straps and a footrest for comfort and stability. **The Saver Basket Stretcher is not suitable for horizontal or vertical lifting with lifting bridles.**

Key Features

- Padded inner for patient comfort
- Hand holes for easy transporting
- Location points for patient restraints
- Compatible with Ferno spine and backboards
- Split version folds in two for easier storage

Product Specifications

| | Code | Length | Width | Height | Weight |
|-----------|--------------|--------|-------|--------|--------|
| One-piece | FWE71SAVER | 218 cm | 61 cm | 19cm | 10 kg |
| Two-piece | FWE71SPSAVER | 218 cm | 61 cm | 19cm | 10 kg |



Ferno Res-Q-Mate Rescue Stretcher Code FWE2060

Ferno's Res-Q-Mate Rescue Stretcher is specifically designed for rapid evacuation in building collapses, mine rescue, helicopter and confined space rescue. The rigid frame also provides an ideal platform to evacuate suspected spinal injuries. Torso and leg flaps comfortably wrap around the patient while a head restraint and four adjustable, colour-coded, chest, thigh and lower leg straps assist in securing the patient. Additional restraint is provided via an exterior v-shaped arm strap and a long foot end strap designed for a figure-of-eight configuration. There are also six built-in carry handles that provide rescuers with various carrying options. Constructed of high grade stainless steel and quality synthetic materials the Res-Q-Mate is impervious to oil, water, grease and other petroleum products making it easy to clean and also resistant to rot and corrosion. When not deployed the unit folds compact and sits neatly inside a heavy-duty reflective backpack. Each Ferno Res-Q-Mate Rescue Stretcher comes complete with a four-point lifting bridle, 50 m tag line system, adjustable head restraint, head pillow and reflective backpack.



| | Length | Width | Depth | Weight with pack & bridle | Load Limit |
|-----------------|--------|-------|-------|---------------------------|------------|
| Folded & Packed | 100 cm | 28 cm | 18 cm | 17.5 kg | - |
| Deployed | 185 cm | 28 cm | 10 cm | 17.5 kg | 180 kg |

Res-Q-Mate Lifting Bridle Code BRB-2063

Designed around the lifting points found on the Res-Q-Mate Stretcher, this bridle is fixed in length for weight distribution and supplied with four lightweight karabiners. 500 kg Working Load Limit.



Ferno Res-Q-Mate Stretcher Handle Kit

Code FWE2062 (Carry Handles pair with bag)

When the Ferno Res-Q-Mate Stretcher needs to be carried for any lengthy period the Handle Kit offers greater carrying options for the rescuer by providing more comfortable and lift friendly positions. The Handle Kit conveniently locks in position at either end of the stretcher. Ideally the Res-Q-Mate Handle Kit should be used with the Ferno Stretcher Handle Shoulder Harness so that the combined weight of the patient and stretcher can be transferred from the arms and evenly shared through the shoulders, chest and back.



shown with optional stretcher handle shoulder harness

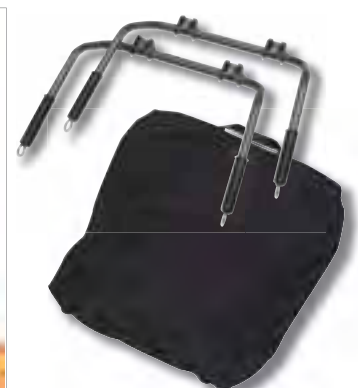

Paraguard Excel Rescue Stretcher Code FWE1411

The Paraguard is designed for a variety of rescues and is a compact and versatile rescue stretcher that is entrenched in NATO and various defence forces around the world. This stretcher is approved for use by many authorities including NATO 6530-99-446-9403. For storage and ease of transport the Paraguard folds and nests within a backpack supplied as standard.

Options and Accessories

- 4 point lifting bridle (BRB-1415)
- Carry handles pair (FWE1412H)
- Shoulder harness system (BRH-1413)
- Valise (FWE1411V)

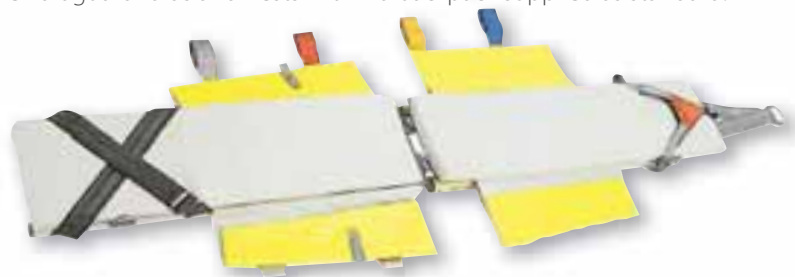

Ferno Vertical Rescue Stretcher *Code VRES STRETCH*

The Ferno Vertical Rescue Stretcher's roll-up, compact and lightweight design makes it ideal for high angle, confined space, horizontal or vertical rescue. When deployed the wrap-around concept becomes rigid and gives the patient a feeling of security as well as protecting limbs and body from further injury during evacuation procedures. The Vertical Rescue Stretcher is fitted with many carry handles as well as six lifting slings that provide a good variety of options for transportation and lifting. Also supplied standard is an integral and comprehensive, colour-coded, full body restraint system that includes a padded head restraint, six over body restraints, shoulder and groin straps along with a generous foot strap to assist with vertical lifts. When not in use the Vertical Rescue Stretcher rolls up and is easily housed within the cordura storage bag which doubles as a backpack. Also available in military colours.

Key Features

- Constructed from internal high density polyethylene with a mixture of tough 1000 and 1680 denier Cordura with a heavy polyurethane coating
- Various carry handles and lift slings provide many options for transport or evacuation lifting
- Integral, colour-coded, head, shoulder, groin and foot restraints
- Six exterior restraint straps assist to wrap and secure stretcher around the patient
- Includes a Cordura storage bag with backpack shoulder straps

Product Specifications

| Length | Width | Weight | Load Limit Horizontal | Load Limit Vertical |
|--------|-------|--------|-----------------------|---------------------|
| 202 cm | 77 cm | 8 kg | 350 kg | 250 kg |



Ferno VRS 6 Point Lift Bridle

Code BRB-VRS

The Ferno VRS 6 Point Lift Bridle has been designed specifically to fit the Vertical Rescue Stretcher. Each adjustable sling arm is colour coded and identified to ensure correct placement. Rated to 25 kN

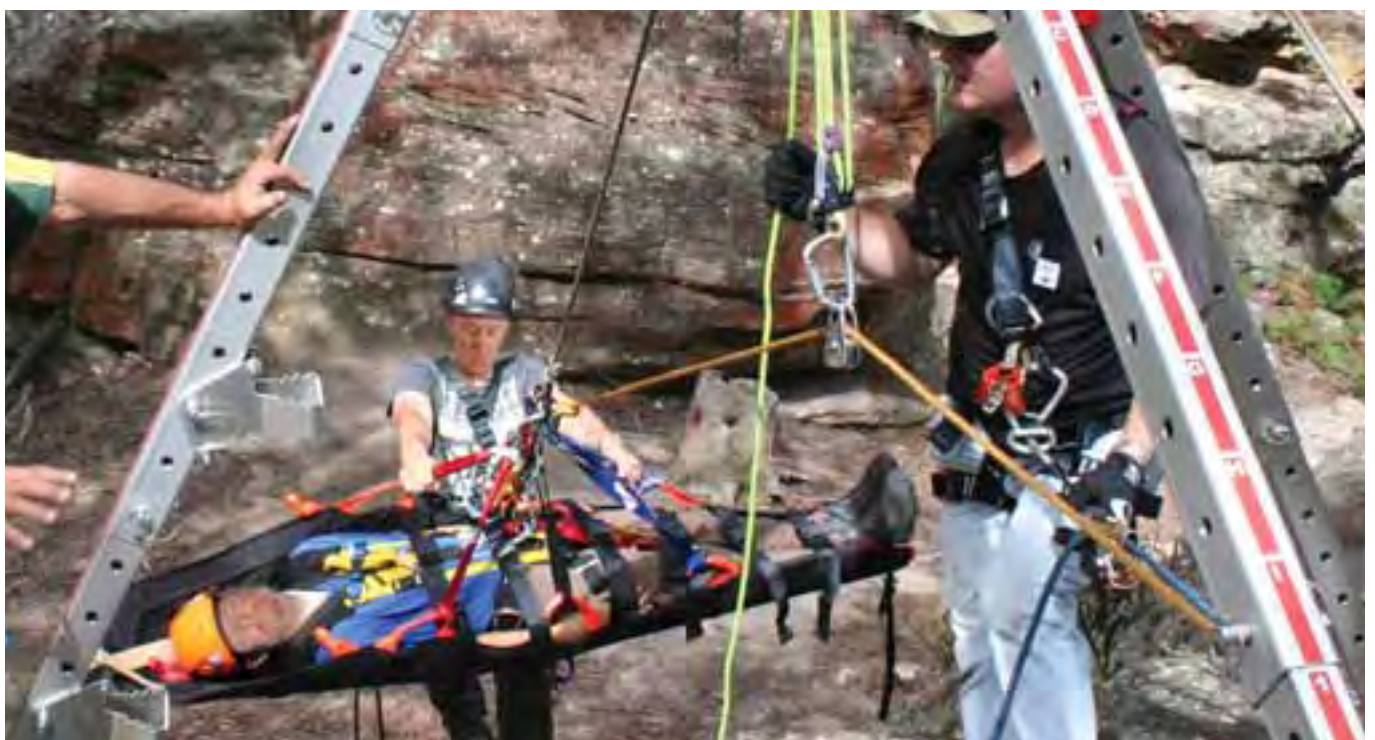

Med Sled Vertical Lift Rescue *Code MS-MS36VLR (red) MS-MS36VLR-DO (drab olive) MS-MS36VLR-CB (coyote brown)*

The Med Sled Rescue is an innovative, cost effective rescue device designed specifically for vertical or horizontal lift operations. It dramatically reduces the effort required for moving and rescuing the wounded and gives you all the traditional functionality and tactical evacuation methods with a compact, durable and less complicated system.

Key Features

- Faster deployment, no assembly required
- Integrated hoist system for quick lifting (pre-assembled)
- Requires minimum deployment training
- Lightweight, 7.7 kg
- Minimum components enable immediate deployment
- Utilises high density and very durable polyethylene
- 4535 kg rated perimeter tether secures the patient and expedites the evacuation process
- 1818 kg rated cross straps with side release, quick connect buckles
- Decontamination capable
- Slides easily for safe and immediate evacuation
- Vertical and horizontal lifting bridle included
- Lifting bridle rated to 4535 kg
- Rapid deployment backpack with four exterior pockets included
- Packaged compact, ready for use, no assembly required.
- Available Coyote Brown, Red or Drab Olive



Optional Molle Bag

Med Sled Emergency Rescue Sled *Code TBA*

The Med Sled Emergency Rescue Sled is designed to leave no one behind. When timing is critical, the Rescue Sled enables an individual to transport a person or enable a one-on-one rescue in a difficult evacuation situation. The Med Sled is ideal where a person is difficult to recover and transport such as a gorge, trench, stairwells or in hostile environments. The Med Sled is made from durable plastic that protects the patient and dramatically reduces the effort of moving wounded. Supplied with a tether to pull or attach to rescuers waist, three patient secure straps and eight handles for lifting and carry bag. Weight 2.7 kg. Available Red, Coyote Brown, Drab Olive or Black.



SKED Rescue Stretcher Code CMC752001

Compact storage, ease of use and flexibility while transporting has made the SKED Rescue Stretcher popular with rescue squads, military and ski patrols. Made from a heavy sheet of plastic, the stretcher becomes rigid when folded around the patient. A variety of handles and straps assist with multiple forms of stretcher transportation including vertical and horizontal lifts with rope systems and helicopter transportation. These handles and straps also help with towing the stretcher. Sliding is made possible with the smooth bottom surface of the stretcher. The full system comes complete with the stretcher, Cordura nylon backpack/towing harness, 2 x straps, horizontal lift slings, vertical lift sling, large steel karabiner and four removable web handles.



| Length | Width | Weight |
|--------|-------|----------------------|
| 91 cm | 23 cm | 8.2 kg (full system) |

Ferno LifeSaver Rescue Stretcher Code FWELS

The Ferno LifeSaver Stretcher is a modern version of the traditional Neil Robertson Stretcher and is designed to be both quick and easy to use in horizontal and vertical lift situations where minimum bulk is a consideration. The LifeSaver Rescue Stretcher comes complete with integral leg and torso flaps that envelope the patient like a traditional corset which is complimented by a simple head restraint, five built-in patient restraints and a long foot strap. It is fitted with various carry handles and stainless steel rings that are used at the foot and head end for guiding and lifting the stretcher in vertical applications. The compact, roll-up design makes storing and transporting the stretcher easy. The LifeSaver Rescue Stretcher is made with full length 5 mm ribs interwoven in tough 1000 denier, high tenacity, nylon fabric to provide full body splinting in a very narrow patient package. Also available in military colours.



| Length | Width | Height | Weight | Load Limit |
|--------|--------|--------|--------------------|------------|
| 153 cm | 104 cm | 3 cm | 5 kg (full system) | 159 kg |

CMC Rescue Stretcher Pack Code CMC432401

Designed to hold stretcher harnesses, stretcher straps, tie-in straps or web, and anything else you need to go with your stretcher. Convenient velcro straps allow the bag to be connected to the stretcher rail. The stretcher pack features a handle and karabiner loops and is made from tough cordura nylon. Size: 51 cm x 18 cm



Ferno Tagline Set Code VRES TAGLINE

A tagline controls the movement of the stretcher during a short haul or hoist operation. The Ferno Tagline Set includes 50 m of 3 mm cord, a steel oval maillon rapide (quick link) and a quick release stainless steel snap shackle. It is stored in a bag that is large enough to fit other stretcher accessories if required. Weight 600 g.



Ferno Adjustable Lifting Bridle

Code BRB-TLB (24 mm screw gate karabiner) and BRB-TLB-TX11S (65 mm screw gate karabiner) and BRB-TLB-LTA (large triplock karabiner)

The Ferno Adjustable Lifting Bridle is available with a variety of karabiner options. Each of the four arms are adjustable and quickly set for individual rescue requirements. UV resistant webbing rated at 2520 kg (25 kN) with hardware wear strips and bright orange tabs for identification of the adjustment buckles. The BRB-TLB (small, screw gate karabiners) is suitable for the Traverse Titan and Gazelle Stretchers. The BRB-TLB-TX11S (large, steel, screw gate karabiner) and the BRB-TLB-LTA (large, steel, triplock karabiner) have extra large gate openings making them suitable for use with the Ferno 71 Series stretchers.



Rescue Bridle Attachment System

Code BRB-LBRA

The Ferno Rescue Bridle Attachment System allows the attendant to be optimally positioned at the side of the patient when being hauled, lowered or airlifted alongside a litter or basket stretcher. The complete system contains a 5 step etrier, daisy chain, rope grabs, 3 m of rope and all other necessary hardware.



CMC Rescue Vertical-Lift Stretcher Harness

Code CMC724133

The Vertical-Lift Harness eases the transition over an edge when a high anchor point is not available, such as a parapet roof, window, tank top or handrail. This reduces manpower requirements, improves patient care and reduces risk. The spreader bar allows the stretcher to pivot between the side straps as the head of the stretcher clears the edge. Weight: 1.3 kg. Delta Quick Link included.



Traverse Mule II Stretcher Wheel

Codes TRAV11-0110 (Mule Stretcher Wheel Only) and TRAV11-0111 (Mule Adjustable Handle - one side only)

The Mule II Stretcher Wheel is designed to fit the Traverse Titan, Gazelle and Ferno 71 series baskets and easily accepts any other type and style of basket stretcher. Ideally suited for narrow trails, the all terrain oversized single wheel design allows for ease of movement in the roughest terrain and navigates across slopes without tipping, all while providing the patient with the smoothest possible ride. The Mule II Stretcher Wheel is supplied with two ratchet style stretcher securing straps. The wheel can be quickly and easily removed for storage and transport. The optional, wide set handles, offer flexibility with eight adjustable positions for different operator heights or at its lowest position to assist with loading the litter and general stability. When not deployed the handles fold on top and under the wheel to dimensions not much bigger than the wheel itself.



Deployed with two handles



Folded with handles



Product Specifications

| | Product | Weight |
|-------------|--|---------|
| TRAV11-0111 | Mule Adjustable Handle - one side only | 2.25 kg |
| TRAV11-0110 | Mule II without handles | 15.5 kg |

Traverse Stretcher Handle (Pair) Code FWETBLH

Add a handle to the end of your Traverse Gazelle or Titan Stretchers. The stainless steel handles slide onto the end of the stretcher for easier lifting and carrying. Rubber grips provide a secure grip. For longer hauls attach the Ferno Stretcher Handle Shoulder Harness (sold separately) to the eye on each side of the handle to transfer the weight to your shoulders, chest and back. Weight: 1 kg.



Ferno Stretcher Handle Shoulder Harness Code BRH-2061

Designed to be attached to either the Res-Q-Mate Handle Kit or the Traverse Stretcher Handles. For longer hauls and walk outs the Shoulder Harness combined with a handle kit offers rescuers a more comfortable, balanced lift options and transfers weight solely from the arms and distributes to the shoulders, chest and back.

Traverse Basket Backpack Code TBA

The Traverse Basket Backpack is designed to house a split Titan basket and has plenty of volume for carrying other rescue essential gear. The backpack includes contoured backpack-style, padded shoulder straps, a variety of handles for handling an outer pocket for gear separation and a large three sided zip for uninterrupted access to the stretcher and contents.



CMC Rescue Original Litter Shield

Protect your patient from further trauma during stretcher evacuations and carry outs. The shield provides the patient with protection from falling rocks and debris, inclement weather and scrub without compromising access to and visibility of the patient's head. Moulded of thick Lexan, the Litter Shield offers impact resistance with the clarity and weather-ability of glass.

The CMC Original Litter Shield attaches to a mount on the stretcher rail that allows the shield to pivot and nest on top of the stretcher side rails. A quick release pin allows the shield to be completely removed if necessary. Weight: 2.7 kg.

Each shield requires a railing clamp that must be ordered separately.



| | | | |
|------------|--------------------------------------|------------|---|
| CMC740000 | Litter Shield, Original, CMC Rescue | CMC 740016 | Railing Clamp for Traverse Titan Series |
| CMC 740011 | Railing Clamp for Gazelle Stretchers | CMC 740017 | Railing Clamp for Advantage Basket |
| CMC 740012 | Railing Clamp for Ferno 71 Series | CMC 740015 | Pin, Litter Shield Replacement, CMC |

Ferno 471 Floatation Collar Code FWE471

An orange 3 m long floatation collar that folds around the outer head end perimeter of basket stretchers to assist rescuers in keeping the patients head above water line. The floatation collar provides over 20 kg of floatation and attaches with 14 side release buckles providing flexibility for a variety of stretcher shapes. Made with polyethylene foam covered with a nylon shell. Can be easily stored inside the basket stretcher and is compatible with the Gazelle, Titan and Ferno Series Basket Stretchers.



Traverse Stretcher IV Pole

Carrying an IV bag while manoeuvring a stretcher along a trail is difficult at best and runs the risk of injuring your patient. The Traverse Stretcher IV Pole provides a place to suspend the IV bag when you need it, but quickly unclips from the mounting block for storage. Height: 51 cm Weight: 539 g

| Code | Description |
|---------------|-----------------------------|
| FWETBIV | Traverse Stretcher IV Pole |
| TRAV-15-00120 | Mount for Gazelle Baskets |
| TRAV-15-00118 | Mount for Titan Baskets |
| TRAV-15-00119 | Mount for Advantage Baskets |



Traverse Rescue Pillow/Blanket Code TRAV-EB700YP

The Traverse Rescue Pillow is made from an easy clean vinyl and conveniently holds a Traverse blanket that can be removed from the case and used to keep the patient warm or the blanket can stay inside the case to be used as a pillow. The pillow has two velcro attachment strips on the back to prevent it from slipping or falling out. The blanket is made of an extremely lightweight fleece and is washable.



Ferno Patient/Stretcher Cover Code FWESC

The Ferno Patient/Stretcher Cover protects bedding, equipment and will keep patients dry in inclement weather. It is made from lightweight, coated nylon the cover contains a dual zip that opens from both ends to access patient or equipment. The cover can be rolled or folded and stuffed into its self contained storage pouch which can be attached to the stretcher with the integral Velcro attachment straps. The Ferno Patient/Stretcher Cover has a full length, elasticised rim and outer Velcro straps that allows it to be fitted to any cot or basket stretcher or patient. Supplied in lime green, no reflective.

Supplied in lime green, no reflective.



Ferno Stretcher Carry Cases

Ferno offers a range of carry cases to suit many of the stretchers shown in this catalogue. Made from heavy-duty, rip-stop, PVC.

- MCC-383B Carry case for 108AF Pole Stretcher
- MCC-385A Carry case for Ferno 11 Stretcher
- MCC-889 Carry case for Najo Backboards and 889P Spineboard
- MCC-385C Carry case for EXL and Saver Scoop Stretchers
- MCC-387A Carry case for one-piece basket stretchers
- MCC-387B Carry case for two-piece basket stretchers
- MCC-2040 Carry case for Ferno 2040 Series Stair Chairs
- 031-4023 Carry case for Ferno 59T and 59 Evacuation Chair



Military



When you're being tested in difficult or hostile situations, having complete trust in your gear is not negotiable.

You'll get that peace of mind with innovative equipment designed by Ferno Military Systems' talented group of Product Designers, Engineers, and Machinists.

Self-confessed gearheads with die-hard passion for big boys' toys, their out-of-the-box thinking has conceived a range of impressive, high-performance aeromedical and tactical evacuation equipment.

Designed, built and tested for rugged conditions, the range includes litters that deploy in seconds, strong, stable in-vehicle litter platforms, self-contained trauma pods, multi-functional ladders and more.

Ferno Military Systems' mission is to provide combat medics with innovative, lightweight, durable and efficient products that improve healthcare delivery to the modern war fighter. Mission complete.

Litter Ladder

The Litter Ladder is a lightweight and durable dual purpose platform. The primary function is an assault ladder the secondary function is an evacuation platform. Features include, standard NATO litter dimensions, quick-release stow able feet and folding handles. Handles fold inboard 90 degrees to allow loading into vehicles, as well as, fold outboard 45 degrees to aid with carrying a casualty. Made from aircraft aluminium



| Code | Length | Length Folded | Width | Load Rating | Weight |
|-------------|---------|---------------|--------|-------------|--------|
| FMS-840A102 | 2254 mm | 1664 mm | 552 mm | 159 kg | 7.6 kg |

FMS Basic Assault Ladder

Ferno Military Systems Basic Assault Ladder weighs as little as 3.4 kg to 4.3 kg depending on length and width. Each ladder can be carried by hand by any war fighter in full combat gear. Made from aircraft grade aluminum, Finished with FMS low noise signature paint. Load capacity not to exceed 136 kg.

| Code | Length | Rung Width | Weight | Load Capacity |
|-----------------|---------|------------|--------|---------------|
| FMS-574A1400-12 | 1830 mm | 304 mm | 3.4 kg | 136 kg |
| FMS-574A1400-19 | 1830 mm | 482 mm | 3.6 kg | 136 kg |
| FMS-574A100-12 | 2130 mm | 304 mm | 3.6 kg | 136 kg |
| FMS-574A100-19 | 2130 mm | 482 mm | 4.3 kg | 136 kg |



FMS Bridging / Climbing Ladders

Ferno Military Systems Bridging / climbing ladders weigh as little as 7 kg to 9.9 kg depending on length and width while providing climbing and bridging capabilities as needed. Each ladder can be carried by hand by any war fighter in full combat gear. Made from aircraft grade aluminum, finished with FMS low noise signature paint. Special Use (SU) ladder is designed for K-9 units. Load capacity of 136 kg

| Code | Length | Rung Width | Weight | Load Capacity |
|---|---------|------------|--------|---------------|
| FMS-598A200 | 2440 mm | 482 mm | 7 kg | 136 kg |
| FMS-598A100 | 3050 mm | 482 mm | 8.8 kg | 136 kg |
| FMS-598A300 | 4267 mm | 482 mm | 13 kg | 136 kg |
| FMS-598A100-SU (Special Use K-9 bridge has no climbing cutouts in sheet metal) | 3050 mm | 482 mm | 9.9 kg | 136 kg |

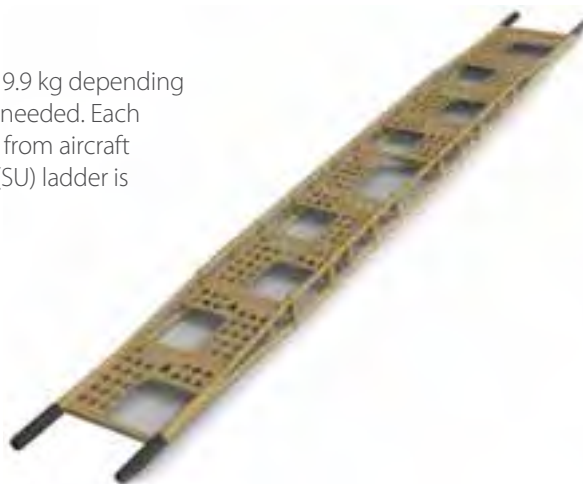

Truss Series 5 Piece Kit

The top of the line Truss Kit consists of a total of 15 pieces giving operators 17 different ladder options to adapt to immediate mission requirements. Segments easily join together and quickly secure in place with quick clamps. Kit includes 1 set of feet, 1 set of rollers and 11 segments. Hand made from aircraft grade aluminium, finished with FMS non-skid, low noise signature coating in Desert Sand.

| Code | Length | Rung Width | Load Rating | Weight |
|---------------|---------|------------|-------------|--------|
| FMS-FA611A100 | 8230 mm | 482 mm | 136 kg | 48 kg |

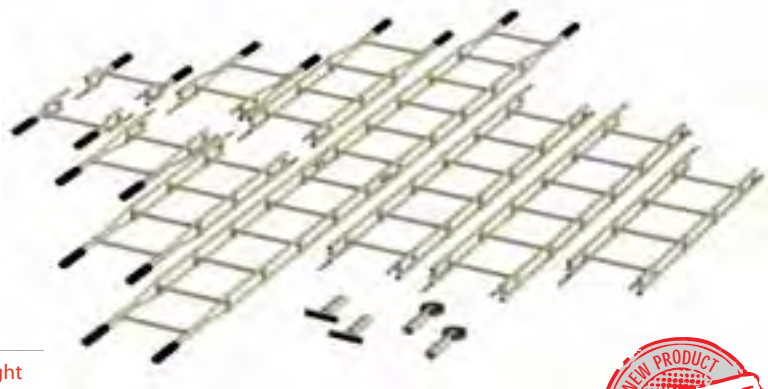

All FMS Assault Ladders are high performance hand-made ladders for professional use only. Every ladder is specifically designed to meet the strict demands of special operator requirements, with the primary focus being featherweight design, low noise signature, strength and durability. Each ladder has a specific weight threshold not to be exceeded and they are not meant for commercial or civilian use of any kind. The sole purpose of all FMS Assault Ladders is to aid the modern war fighter, or law enforcement equivalent, in the acquisition and breaching of targets.

Stingray Poleless Stretcher Code FWESR

Constructed with non-skid, flame-retardant monofilament polypropylene material. Two web straps secure the stretcher around the body, while six heavy-duty handles make it easy to carry. The Stingray is ideal for decontamination roller systems and moving wet patients. The Stingray is tested and approved by US federal and private laboratories using live warfare agents.

Product Specifications

| Extended | | | Folded | | | Weight | Load Limit |
|----------|-------|--------|--------|-------|--------|--------|------------|
| Length | Width | Height | Length | Width | Height | | |
| 198 cm | 61 cm | 5 cm | 31 cm | 31 cm | 31 cm | 0.7 kg | 454 kg |



Ferno 108-D Disaster Litter

The Ferno 108-D Disaster Litter is an economical, lightweight, litter designed for disaster use. It features an aluminium frame and easy-to-decontaminate polypropylene mesh cover with two restraints.

Product Specifications

| Length Open | Length Folded | Width Open | Width Folded | Height Open | Height Folded | Weight | Load Limit |
|-------------|---------------|------------|--------------|-------------|---------------|--------|------------|
| 229 cm | 114 cm | 55 cm | 23 cm | 15 cm | 10 cm | 6 kg | 159 kg |



Ferno 108-T Tactical Litter

The Ferno 108-T Tactical Litter is a strong military litter designed for tactical, HazMat, CBRN, Decontamination, USAR and disaster use. Follows US military Spec MIL-L-49511B and supplied in OD green.

Product Specifications

| Length Open | Length Folded | Width Open | Width Folded | Height Open | Height Folded | Weight | Load Limit |
|-------------|---------------|------------|--------------|-------------|---------------|--------|------------|
| 234 cm | 118 cm | 57 cm | 19 cm | 14 cm | 18 cm | 8 kg | 544 kg |

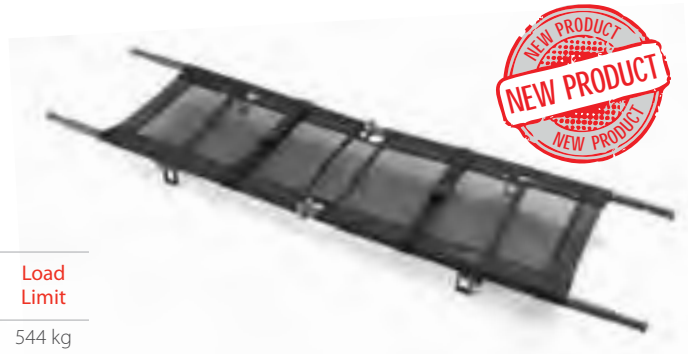

APE Litter Code FMS-800A100

The ALLEvac™ All Platform Evacuation Litter is for dismantled, vehicle, helicopter and fixed wing operations. The APE Litter is optimum for every platform, deploys in seconds and represents the future of tactical evacuation. It is durable and repairable with a low effective life-cycle cost. The APE is infinitely sustainable, the litter beds, handles and frame sections can be field replaced utilising a Phillips head screwdriver. Deployed units can now utilise a parts cache or cannibalise one litter to keep the remainder of the inventory in service. The APE is the ultimate full system combat litter.



Product Specifications

| Length Open | Length Folded | Folded Height | Folded Width | Length Handles Folded | Weight | Load Rating |
|-------------|---------------|---------------|--------------|-----------------------|--------|-------------|
| 230 cm | 37 cm | 48 cm | 15 cm | 188-196 cm | 8.6 kg | 159 kg |

AlIEvac™ NATO Litter Clamp

The AlIEvac Nato Litter Clamps allow critical medical equipment to be attached to any NATO style litter. Each kit includes a mount for the device as well as our Universal Litter Clamp. A two stage quick release allows the medical device to be removed from the mount as needed or detached from the clamp and placed on any vertical surface using our Standard or Mini-Track System.

CNC machined from aircraft aluminium.



AlIEvac™ NATO Litter Clamp
Propaq® MD
Code FMS-400A106



AlIEvac™ NATO Litter Clamp
Sequal®Saros™
Code FMS-400A101



AlIEvac™ NATO Litter Clamp
Tempus IC
Code FMS-400A104

Compact Litter Stand

AlIEvac™ Compact Litter Stands are specifically designed with immediate deployment in mind and fold small enough to fit in a Pelican 1650 Deployment Case or the LBT Medium Load Out Bag. Standard mounting points accept an optional Mayo Tray and IV Pole for expanded treatment capability. The Stands have been load and cycle tested to support 227 kg in thousands of uses to always provide a safe and stable treatment platform. The AlIEvac™ Compact Litter Stands will accept all rigid NATO litters.

Product Specifications

| Title | Code |
|--------------------------------|-------------|
| Compact Litter Stand | FMS-840A101 |
| IV Pole only | FMS-840A104 |
| IV Pole with Accessory Bracket | FMS-840A105 |
| Accessory Bracket | FMS-840E100 |
| Mayo Tray Kit | FMS-840A103 |



Compact Litter Stand Folded



Accessory Bracket is an interface between IV Pole or Mayo Tray Kit and the Compact Litter Stand



AlIEvac™ IV Pole is a rugged lightweight IV pole.



AlIEvac™ Mayo Tray Kit includes a Mayo Tray, Folding and Accessory Bracket. Designed for simple and rapid deployment. Load Rating 4.5 kg

ALLEvac™ Litter Arms

The ALLEvac™ Universal Litter Arms provide a strong, stable and lightweight platform for any NATO style litter in any military vehicle, from ATVs to AV's. The ALLEvac Litter Arms simplify evacuation of litter casualties and eliminates many of the challenges of tactical vehicle evacuation. They are extremely lightweight yet load-tested to hold one critical casualty and exceed the U.S. army cross country mobility load requirements. Both litter arms offer 180° of sideward rotation for storage or can be removed from the wall while the 10 G arm can be stored vertically also. Each arm has a built in ratchet latch with one hand capture and release that will adjust for variations in litter width. Standard fixed position, adjustable position, or custom wall plates and mounting solutions are available for your specific needs. Offered with an anodised finish or interior / exterior chemical agent resistant paint. Available in lightweight 10 G or robust 20 G options.

Product Specifications

| Description | Code |
|--|-------------|
| 10 G Litter Arm with Pivot Housing | FMS-643A200 |
| 10 G Fixed Position Plate 203 mm x 203 mm | FMS-643E130 |
| 10 & 20 G Ferno Track Base Plate 570 mm x 203 mm | FMS-643E134 |
| 20 G Litter Arm with Pivot Housing | FMS-644A100 |
| 20 G Fixed Position Plate 203 mm x 203 mm | FMS-645E106 |



20 G Litter Arm, Pivot Housing and Ferno Track Base Plate



10 G Litter Arm, Pivot Housing and Ferno Track Base Plate



Ferno Track Base Plate



10 G Fixed Position Plate



20 G Fixed Position Plate



ALSP - Air Litter Support Platform

The ALLEvac™ ALSP allows medics or flight crew to effectively load casualties into aircraft, when rapid loading is critical. The ALSP is preloaded in fixed and rotary wing litter stantions and serves as a receptacle platform for loading litter casualties. This reduces the physical burden to the crew and protects nearby casualties from being injured if litters are accidentally dropped.

Product Specifications

| Code | Length | Width | Weight | Load Rating |
|---------------|--------|-------|--------|-------------|
| FMS-FA538A400 | 218 cm | 64 cm | 9.1 kg | 159 kg |



FTS Folding Transport Stretcher *Code FWE-FTS*

The Folding Transport Stretcher is a transporter which has been designed for easy storage in compact areas such as aircraft baggage compartments, vehicle boots and carrying cases. In aircraft operations the FTS can be quickly removed from the baggage compartment and rapidly deployed for moving the stretcher from aircraft to the medical facility. The FTS has four 150 mm locking wheels and is lightweight and compact.

Product Specifications

| Length (open) | Length (folded) | Width | Weight | Load Limit |
|---------------|-----------------|-------|--------|------------|
| 137 cm | 85 cm | 42 cm | 13 kg | 159 kg |



shown with optional NATO litter and litter mount kit

Ferno Transporter 28-A1N (NATO) *Codes FMS-840A111*

The 28-A1N is a lightweight, rugged, proven transporter used by many of today's civilian aeromedical operators. Weighing in at 32 kg, with a load capacity of 318 kg, the 28-A1N is an ideal fit for the UH-72 Lakota. A Ground Compatibility Kit (GCK) option is available making the 28-A1N compatible with local ground ambulances and offers a perfect transport solution for military hospitals. Compatible with all NATO litters.

| Length | Width | Folded Height | Load Height | Weight | Load Rating |
|--------|-------|---------------|-------------|--------|-------------|
| 203 cm | 64 cm | 23 cm | 69 cm | 32 kg | 318 kg |



Ferno Transporter 35-ProXN (NATO) *Codes FMS-840A112*

The 35-ProXN is a lightweight, rugged and proven X-framed transporter designed to secure any NATO litter and is ideal for use in civilian ground ambulances and patient transport within military medical facilities. The 35-ProXN has a low centre of gravity, offering adjustable heights while maintaining a stable platform to move patients as needed. Custom configurations and variants are available.

Product Specifications

| Length | Width | Folded Height | Load Height | Weight | Load Rating |
|--------|-------|---------------|-------------|--------|-------------|
| 201 cm | 61 cm | 33 cm | 86 cm | 39 kg | 318 kg |



LCR - Litter Conversion Rack

The Litter Conversion Rack allows any cargo or passenger van the capability to securely transport (2) casualties. The simple lightweight and low profile design ties down like cargo and allows the conversion rack to be rapidly deployed in seconds. The Conversion Rack gives medics an immediate and stable platform to provide care. Custom ATV and Segway™ trailer variant are also available.

Product Specifications

| Code | Length | Width | Height Extended | Height Collapsed | Weight | Load Rating |
|-----------|--------|-------|-----------------|------------------|--------|-------------|
| FM800A200 | 186 cm | 83 cm | 53 cm | 13 cm | 37 kg | 159 kg |



LSL - Advanced Life Support Litter FM840A109

The Advanced Life Support Litter is designed for critical casualties needing advanced life care transport in ground or air platforms. Integrated "D" rings allow the litter to be tied down like cargo and the truss type design provides strength for aircraft G-loads when supported by its grips. Features include: provisions for an aircraft-grade shoulder harness / mounting provisions for on board oxygen system / adjustable bed surface for both upper and lower torso (including flexed-knee position) / patient surface is isolated from frame to reduce vibration / mattress pad meets aviation flammability requirements / internal storage cassettes for medical equipment and disposables / external IMS Mini-Mount System to secure an array of medical devices / mounting provisions for (4) IV poles / folding grips to fit various ground vehicles. Custom configurations for ECMO transport are also available.

Product Specifications

| Length | Width | Length Handles | | Height | Weight | Load Rating |
|--------|-------|----------------|--------|--------|--------|-------------|
| | | Folded | Height | | | |
| 231 cm | 56 cm | 183 cm | 31 cm | 18 kg | 159 kg | |



Trauma Pod FA608A1000

The ALLEvac™ Trauma Pod is a self contained trauma treatment platform. It gives tactical care providers the capability to provide immediate advanced treatment to critical casualties in the most organized manner. It allows for advanced treatment through the entire continuum of care and can be utilized in mobile evacuation (vehicle, rotary & fixed wing) or fixed casualty collection points. Includes, 8 storage cassettes, provisions for 4 x 400 ltr oxygen cylinders, IV pole mounts and a Lifepak 12 Rail Mount. The Trauma Pod can be customised to your specific resuscitation equipment requirements upon request.

Product Specifications

| Length | Width | Height | Weight | Load Rating |
|--------|-------|--------|--------|-------------|
| 191 cm | 70 cm | 43 cm | 39 kg | 159 kg |



AMST - Air Mobile Surgical Table FA585A1000

The ALLEvac™ AMST is a self contained surgical platform that is Air Worthy Certified for fixed and rotary wing platforms. It provides a rapid surgical capability immediately on arrival in a target area or may be utilised on mission support aircraft. It has provisions for all surgical packs, anesthesia, monitors, oxygen and surgical trays and can be customised to your specific resuscitation equipment preferences. Optional Rough Terrain Mobility Kit is also available.

| Weight | Max Patient Weight | Max Equipment Weight | Maximum Weight | Length | Width | Height |
|--------|--------------------|----------------------|----------------|--------|-------|--------|
| 139 kg | 113 kg | 156 kg | 408 kg | 203 cm | 61 cm | 76 cm |



Custom Interior Vehicle MOLLE

ALLEvac™ Custom Modular Wall Plates provide a lightweight and rugged multi-equipment mounting surface inside a vehicle, allowing crew members to customise vehicle interiors to meet immediate mission requirements. FMS Custom Wall Plates are compatible with our entire line-up of ALLEvac™ Litter Arms and medical device mounts. Contact Ferno Australia for details.



CPR / Rescue Manikins

Rescue Stretchers

Tactical Evacuation

Edge / Rope Rescue Gear

Rope / Rope Care Gear

Rescue Tools / Knives

Disaster / PPE / Lighting

AllEvac (IMS) Integrated Mount System Standard Series

The Standard Series is a larger more robust group of wall mounts in the IMS family. Designed for use on any vehicle platform in any environment or any application where space and weight are not as critical, or where heavier devices need to be mounted. The simple quick-release system consists of a wall plate & medical device mount - or a universal mount and an adaptor attached directly to the device. This system allows any medical device employing the Standard IMS to be rapidly installed or removed as needed. CNC machined from aircraft aluminium all IMS products are 20 G test in all directions.

The Generic Equipment Mounts

MOLLE. Available with or without pre-drilled mounting provisions to allow for a full custom fit for your choice of equipment. A single quick-release allows for rapid installation and removal of mount from wall.



The Universal Equipment Mount

The Universal Equipment Mount serves as an interface between devices where IMS Adaptors are used with our Ferno-Track, Fixed Position Plates or Custom Interior Vehicle MOLLE. This mount is compatible with any type of medical device, in conjunction with the appropriate adaptor. The two stage quick-release allows for rapid installation or removal of the device itself and rapid installation, adjustment and removal from the Ferno-Track.



Sonosite Folding Mount

Generic Mount base attached directly to the M-Turbo® unit. Quick-release provisions allow for rapid installation or removal from Ferno-Track, Fixed Position Plates or Custom Interior Vehicle MOLLE and allows the M-Turbo® to be folded upright against the wall of the vehicle. Includes provisions for docking station.



Propaq® 206 Swivel Mount

Generic Mount base attached directly to the back of the 206 unit (with or without printer). The swivel mount allows 70° of rotation, four fasteners allow the mount to be installed or removed quickly from the device. Compatible with Ferno-Track, Fixed Position Plates or Custom Interior Vehicle MOLLE.



Sequal® Eclipse Surface Mount

Generic Mount base attached directly to the back of the 206 unit (with or without printer). The swivel mount allows 70° of rotation, four fasteners allow the mount to be installed or removed quickly from the device. Compatible with Ferno-Track, Fixed Position Plates or Custom Interior Vehicle MOLLE.



Impact® 754 / 731 Surface Mount

The Impact® 754 / 731 Surface Mount uses our Generic Mount as its base and includes a storage area for the power cord. Compatible with our 10.G Fixed Position Plate and any of our Standard Ferno-Track or Custom Interior Vehicle MOLLE. Quick-release provisions allow rapid installation or removal. Made from aircraft aluminium.

Ferno IMS Equipment Adaptors

Any Ferno IMS Equipment Adaptors mount directly to the back of a device and once in place it serves as an interface between the device and our Universal Mount. Fasteners allow the adaptor to be installed or removed quickly from the device as needed. CNC machined from aircraft aluminium.

Propaq® 206 Adaptor



Adaptor only



Adaptor on device



Device on Ferno Track Base

Impact® 754 / 731 Adaptor



Adaptor only



Adaptor on device



Device on Ferno Track Base

Belmont® Buddy Plus™ Adaptor



Adaptor only



Adaptor on device



Device on Ferno Track Base



Product Specifications

| Description | Code |
|---|---------------|
| Generic Equipment Mount 6 x 6" | FMS-643A310 |
| Generic Equipment Mount 6 x 6" Pre-Drilled (pictured) | FMS-643A315 |
| Generic-X Equipment Mount 6 x 6" | FMS-643A310-X |
| Generic-X Equipment Mount 6 x 6" Pre-Drilled (pictured) | FMS-643A315-X |
| Universal Equipment Mount | FMS-829A3100 |
| Sonosite Folding Mount | FMS-829A1700 |

| Description | Code |
|---------------------------------|--------------|
| Propaq® 206 Swivel Mount | FMS-821A250 |
| Sequal® Eclipse Surface Mount | FMS-400A107 |
| Impact® 754 / 731 Surface Mount | FMS-500A107 |
| Propaq® 206 Adaptor | FMS-829A1500 |
| Impact® 754 / 731 Adaptor | FMS-829A1200 |
| Belmont® Buddy Plus™ Adaptor | FMS-829A8000 |





AllEvac (STM) Single Track Mounts

AllEvac STMs are an array of universal and equipment dedicated mounts that allow you to install items on to standard Ferno-Track, Fixed Position Plates or Custom Interior Vehicle MOLLE. Each AllEvac STM is CNC machined from aircraft aluminium.

AllEvac Single Track Stud

AllEvac Single Track Stud is a semi-permanent stud designed to install items of mass. Available in size 10/32" or 1/4" fasteners.



AllEvac Single Track Mount

AllEvac Single Track Mount can be used in a horizontal or vertical orientation and be cut to custom lengths as needed for larger equipment. Quick-release provision allows the mount to be rapidly installed, adjusted or removed as needed.



AllEvac Single IV Bag Hook

AllEvac Single IV Bag Hook is designed to hold one IV bag and can be used in a horizontal or vertical orientation. Quick-release provision allows the mount to be rapidly installed adjusted or removed.



AllEvac Double IV Bag Hook

AllEvac Double IV Bag Hook is designed to hold two IV bags and has a quick-release provision that allows the mount to be rapidly installed, adjusted or removed.

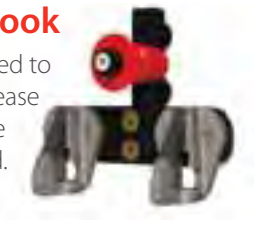

AllEvac IV Bag Velcro Wrap

AllEvac IV Bag Velcro Wrap is designed to secure the bottom of any IV bag when installed with our IV Bag Hooks. The Velcro Wrap has a quick-release provision that allows the mount to be rapidly installed, adjusted or removed as needed.



AllEvac Overhead IV Hook

A single quick-release allows the IV Hook to be rapidly installed or removed as needed with folding feature.



AllEvac IV Bag Mount

AllEvac IV Bag Mount incorporates our IV Hook and Velcro Strap into one mount and is designed to secure one IV bag. A single quick-release allows the mount to be rapidly installed or removed as needed.



AllEvac SureTemp® Plus 690 / 692 Thermometer Holster

Designed to secure one Welch Allyn SureTemp® Plus 690 or 692 Digital Thermometer. A single quick-release allows the Holster to be rapidly installed or removed.



AllEvac Task Light

AllEvac Task Light provides a rapidly deployable source of light inside any vehicle. Quick-release provision allows the mount to be rapidly installed, adjusted or removed as needed.



AllEvac Propaq® MD Surface Mount

A simple low profile design that is compatible with any horizontal surface. The adjustable and removable clamp allows medics to position the Propaq®MD as needed. Includes telescoping IV pole.



Product Specifications

| Description | Code |
|-----------------------------------|-------------------|
| Single Track Stud 10.32 | FMS-500A102-10.32 |
| Single Track Stud 1.4 | FMS-500A102-1.4 |
| Single Track Mount 2.75" / 2 Post | FMS-500A103 |
| Single IV Bag Hook | FMS-500A103-IV-1 |
| Double IV Bag Hook | FMS-500A103-IV2 |

| Description | Code |
|--|-------------|
| IV Bag Velcro Wrap | FMS-500A105 |
| Overhead IV Hook | FMS-829A615 |
| IV Bag Mount | FMS-500A109 |
| SureTemp® Plus 690 / 692 Thermometer Holster | FMS-500A106 |
| Task Light | FMS-500A104 |

AllEvac (IMS) Integrated Mount System Standard Series Pro Series

Our Pro Series is the lightest group of surface mounts in the IMS family. Designed for use on any platform in any environment or any application where space and weight are critical. The simple three piece, two stage system consists of a base plate, an adaptor that attaches to the medical device and the Mini ProV Universal Receiver Adaptor. The complete system allows equipment to be rapidly installed or removed as needed. All IMS Pro Series products are CNC machined from aircraft aluminium and 20 G tested in all directions.

Mini-Track

The Mini-Track serves as the base plate of the Mini ProV Universal Receiver and can be installed to any structurally appropriate surface. Designed with Aeromedical applications in mind the Mini-Track allows for either vertical or horizontal adjustability once installed and is available in pre-cut or custom lengths as needed.



Mini ProV Universal Receiver

A two stage quick-release allows any medical device with a Pro Series Adaptor to be installed or removed from the ProV Receiver as well as allowing rapid deployment, adjustment or removal of the ProV Receiver from the Mini-Track.



IMS Pro Series Equipment Adaptors

Ferno has developed numerous ProV Adaptors to suit mission critical equipment. The adaptor mounts directly to the back of the device and once installed serves as an interface between the device and our ProV Mini Receiver. Set screws allow the adaptor to be installed or removed quickly from the device as needed. Examples of some adaptors follow.



ZOLL Propaq® MD with Mini ProV Adaptor



Bellmont® Buddy Plus™ with Mini ProV Adaptor



Impact® 754/731 with Mini ProV Adaptor



BMOS LOX with Mini ProV Adaptor

Product Specifications

| Description | Code |
|---------------------------------------|----------------|
| Mini-Track Base Plate 2.25" x 7" | FMS-100E100-7 |
| Mini ProV Universal Receiver | FMS-300A100 |
| ZOLL Propaq® MD Mini ProV Adaptor | FMS-300A102-MD |
| Impact® 754 / 731 Mini ProV Adaptor | FMS-829A210 |
| Belmont® Buddy Plus Mini ProV Adaptor | FMS-829A190 |
| BMOS LOX Mini ProV Adaptor | FMS-400A103 |
| AllEvac Propaq® MD Mini Pole Mount | FMS-300A104 |

AllEvac Propaq® MD Mini Pole Mount

Our new ProV Mini Pole Mount was designed for use with the Propaq® MD however the mount is compatible with any device employing the ProV System. Easy to install or remove, the mount is semi-permanent providing a surface to rapidly install or remove the attached device.



Ferno Evac Rescue Descent Kits

Ferno Evac Rescue Descent Systems contain all the gear you need to self rescue or evacuate one to two persons from towers, wind turbines, masts, high bay lift trucks, cranes or similar. A controlled rate descent device with a 15:1 geared recovery mechanism provides lifting capabilities for either one or two person, self rescue evacuation. The standard kit is supplied with 50 metres of 11 mm kernmantle rope that conforms to Australian Standards, customised lengths up to 160 metres can be supplied. Rate of descent: 0.8 m per second depending on operator competence and fitness. Each kit meets standards EN 341 Class A, EN 1496 Class A, ANSI Z359.4

| Qty. | Code | Description |
|------|----------------|--|
| 50 m | UL-163-660-602 | 11 mm Kernmantle Rope (additional lengths available) |
| 1 | VBS HIVIS 100 | Heavy Duty Rope Bag 100 m |
| 1 | VCT 595TBZO | Karabiner Steel Triplock 50 kN |
| 1 | VSL S30KN 1500 | Flat Snake Sling 30 kN 50 mm x 1500 mm |
| 1 | VSL R32KN 1500 | Round Sling 32 kN 25 mm x 1500 mm |
| 1 | FWE2090 | Ferno Res-Q-Link Recovery Pole |
| 1 | (as pictured) | Rescue Decent Hardware (choice of 2) |



UL-160-669-507



UL-160-669-509



Mini-Evac 2P Kit



Lift-Evac Kit

Res-Q-Link Recovery Pole Code FWE2090

The Res-Q-Link is a unique and multi functional rescue pole incorporating many features and benefits including:

- Large alloy double action hook compatible with most recovery systems and allowing two configurations to provide versatility when rescuing a fall victim
- Extendable from 150 cm to 280 cm.
- Fibreglass outer pole and rubber coated handle for maximum grip and control in long reach scenarios.
- Torch holder for low light scenarios which is compatible with most slim line torches
- Rope and web cutting knife to cut victim free once a recovery system is attached.
- Additional double action hook available (Code VCT L3536201)

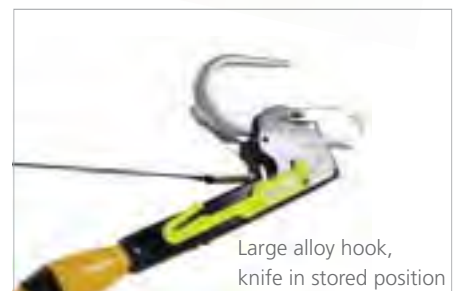
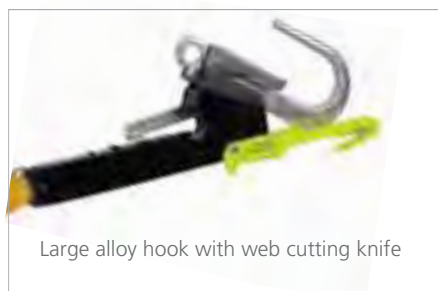
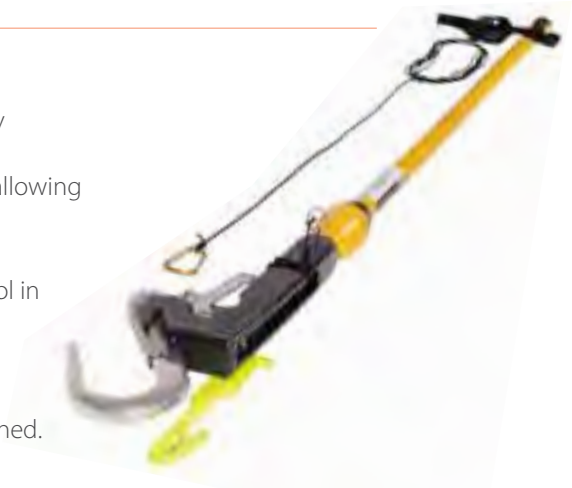



Hi-Safe Rescue Pulley System

Code FWE-CSRK (bag),
FWE-CSRD (drum)

Developed for backup and rescue situations the Hi-Safe Rescue Pulley System has a 4:1 lift advantage and a built-in lift and lock system which can be manually overridden. It comes standard with 50 m of rope allowing approximately 12 m of lift. Supplied standard with a heavy duty rope bag, also available with optional dust proof stowage drum.



Optional drum

Ferno Mini Haul Kit

Code VKIT MINI HAUL

The Ferno Mini Haul kit is an extremely compact haul kit that will provide a 6:1 mechanical advantage. It features a V-shaped cleat that if required, enables the operator to lock off the system during a hauling operation. The Ferno Mini Haul Kit is rated for one person rescue only.



CMC CSR Pulley Kit

Code CMC500102

The CMC CSR Pulley Kit is 4:1 rescue system that is provided with a pulley that is easy to release under load. The new aluminium pulleys swivel at both ends of the system eliminating any potential twisting of the lines. The CMC CSR Pulley Kit is an excellent choice for confined space entry or rope access where a heavy duty pulley system is required. Supplied with 30 m CMC Rescue Static Pro Lifeline, 2 karabiners, 2 pulleys and rope bag



RALF Rescue Retrieval System

Packaged ready to rescue, no assembly required. The RALF Rescue Retrieval System allows you to quickly raise or lower a person. The system includes an integral braking system in case accidental release of rope by the rescuer.



| Qty | Description |
|-----|-----------------------------|
| 2 | Triplock Alloy Karabiners |
| 1 | RALF Rescue Locking Pulley |
| 2 | Medium Prusik Pulley Double |
| 1 | Maillon Rapide - Twist |
| 1 | 25mm Round Sling 1200 mm |
| 50 | 11 mm Kernmantle Rope |
| 1 | 50 m Heavy Duty Rope Bag |



ResQmax Line Deployment Kit

Codes CMC564000 (with SCBA filler hose), CMC564001 (with SCUBA filler hose) and CMC564002 (with DIN filler hose)

The ResQmax Line Deployment Kit contains everything you need to launch a 3 mm messenger line up to 107 m. The Dacron line is 152 m in length and has a tensile strength of 500 lbf. Once you have the messenger line across, use it to pull across the rescue rope.

Kit Includes

- 1 x ResQmax launcher with folding stock
- 1 x Red streamline line projectile with two spare moulded projectile protectors
- 1 x 152 m dacron messenger line with compact line container
- 1 x Spares kit
- 1 x Corrosion block lubricant/rust inhibitor, 118 mL
- 1 x Streamline filler hose assembly
- 1 x Cordura kit carry bag, red/black
- 5 x Streamline nozzle protectors
- 1 x Operator's manual
- 1 x Training CD





arachnipod

The Ferno Arachnipod is the world's most versatile modular total edge management system (TEMS). Components can be added or removed as required so that the Arachnipod complements existing structural or natural features. The unique design of the patent-pending modular head means the Arachnipod can be constructed into many different configurations including a ginpole/monopole, bipod, tripod, quadpod, bridge system and handrail recovery monopole.

For heavy loads, four legs can be used to form a quadpod and increase the safe working load (SWL). Its versatility makes it an ideal system for workers in industries such as rescue and emergency services, construction, military, utility services, mining, film and maintenance. Approved to CE Standard EN 795B

Configurations



Gin Pole/Monopole



Handrail Recovery Monopole



A-Frame



Sideways A-Frame using pulley head

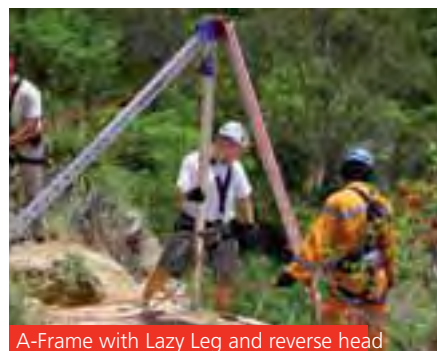

A-Frame with Lazy Leg and reverse head



Tripod



Tripod as High Directional System



Bridge System



Quadpod

How It Works

The Arachnipod, in its most basic form, is a simple tripod with the three legs independently pivoting from an anodised aluminium head. The modular head has a similar design to a door hinge. Inserting or removing a pin through the centre of the head allows the quick and simple addition or removal of components to create a configuration to suit any edge management scenario. Each head section contains a shackle for guying while an optional in-built twin grooved stainless steel pulley is also available.

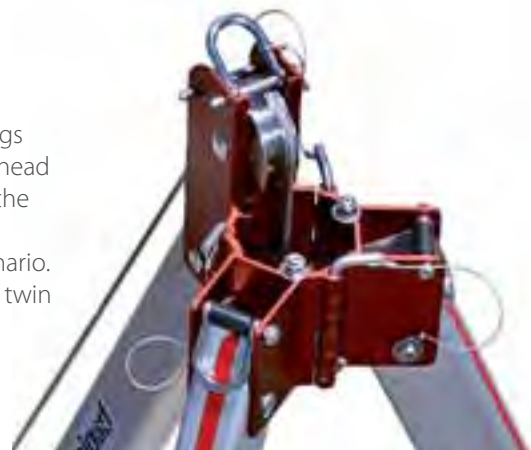

Accessories



Standard foot



Hold-down stake



Spike foot



Soft ground shoe



Arachnipod step



Winch and mount



Lazy leg extender kit



Type 3 fall arrest block with mount bracket



Gin head



Rigging plate

Quad plate



Lazy leg Adapter



Reverse head



Equipment bracket



Accessory kit

Arachnipod Kits

The modular design of the Arachnipod offers customers with limited budgets an option to purchase a basic unit and upgrade components at a later date to make a more advanced system. Minimal space is needed to store an Arachnipod as it flat packs for simple and convenient storage. There are numerous kits available for purchase ranging from the basic tripod through to a total edge management system (TEMS). The table below will help you decide which kit is best for you.

Arachnipod Tripods

| Components | Tripod Style | | | |
|-----------------------|--------------|-----------------|-----------------|-----------|
| | Industrial | Industrial Plus | Advantage Basic | Advantage |
| Standard leg | 3 | 2 | 2 | 1 |
| Pulley leg | | 1 | | 1 |
| Lazy leg | | | 1 | 1 |
| Lazy leg adapter plug | | | 1 | 1 |
| Foot tether rope | 1 | 1 | 1 | 1 |
| Arachnipod bag | Optional | Optional | Standard | Standard |

Arachnipod Kit Contents

| Contents | Kit | | | | |
|---|--------|-------------|----------------------|----------------|------|
| | Rescue | Rescue Plus | Advantage Basic Plus | Advantage Plus | TEMS |
| Industrial plus tripod | 1 | | | | |
| Advantage tripod | | 1 | | 1 | 1 |
| Advantage basic tripod | | | 1 | | |
| Arachnipod bag | 1 | 1 | 1 | 1 | 1 |
| Rigging plate | 1 | | 1 | 1 | |
| Spike feet | 3 | | | | |
| Quad plate | | | 1 | 1 | |
| Reverse head | | | 1 | 1 | |
| Gin head | | | 1 | 1 | |
| Full accessory kit | | 1 | | | 1 |
| Advantage accessory kit bag | | | 1 | 1 | |
| 2 m or 3 m or 4 m bridge kit in bag with spare leg and foot tether rope | | | | | 1 |

Extra legs and all accessories can be ordered separately to suit custom requirements

| Full accessory kit contents | Qty |
|-----------------------------|-----|
| Accessory bag | 1 |
| Spike feet | 4 |
| Gin head | 1 |
| Soft ground shoes | 4 |
| Hold down stakes | 4 |
| M12 Tru-bolts | 8 |
| M12 masonry drill bit | 2 |
| Spare Qik-link head pins | 2 |
| Spare detent pins | 2 |
| Spare Ball-lock leg pin | 1 |
| Steps | 2 |
| Equipment bracket | 1 |
| Rigging plate | 1 |
| Quad plate | 1 |
| Reverse head | 1 |

Optional extras

| |
|--|
| Bridge kit stainless steel upgrade kit |
| Bridge ratchet strap system |
| Additional standard leg |
| Additional pulley leg |
| Gin head |
| Lazy leg extension kit |
| Lazy leg adaptor |
| 10 m winch and mount (6 mm cable) |
| 20 m winch and mount (6 mm cable) |
| Type 3 fall arrest block and mount |

Hydraulic Rescue System Block (One Man and Two Man)

The quickest way to rescue people from an elevated location. As the evacuee descends the other line end ascends ready for the next person. The hydraulic system is more reliable than mechanical brake systems and minimal heat is generated even after multiple descents. Little maintenance is required and the device can be stored on site or positioned ready for use, no inspection is required until original packaging is opened. Suitable for off-shore application. One Man System has a working load 150 kg. Two Man System has a working load 500 kg. Maximum descent speed 1.5 m per second. Supplied with triplock karabiners and swivel at harness end.

CE EN 341 Certified.



Hi-Safe Tripod *Code HS-TP10*

A simple, heavy duty tripod developed by industry professionals with years of field experience.

Key Features

- Compact head frame reduces weight and size
- Independently adjustable spring loaded legs minimise the risk of accidental closure.
- Zinc plated steel construction
- 2.3 m head clearance
- 2.2 m foot print (at full extension)
- Single swivel bolt attachment point
- Supplied with foot tether
- SWL 180 kg with 7:1 safety factor
- Rated 2 person rescue - 1 person working



Optional Hi-Safe Rescue Pulley System



Optional Hi-Safe Rescue Winch

Hi-Safe Tripod Bag *Code HS-TP CARRY BAG*

A purpose made bag for the Hi-Safe Tripod. This bag is made from 1680 black cordura and has a full length zipper, reinforced ends, two carry straps and a full length shoulder strap with padding.



Hi-Safe Rescue Winch *Code HS-RW20T (tripod), HS-RW20D (davit)*

The rescue winch has been developed to be attached to either the Hi-Safe Tripod or Davit System. The Rescue Winch utilises a Weston Brake System with steel gears, back up brake and is supplied with 20 m of cable. It works on a basic wind up, wind down principle.

The Hi-Safe Rescue Winch is rated at 180 kg with a 7:1 safety factor. Developed for one person working or for two persons rescue.

Comes complete with a re-direct pulley.

Weight: 7 kg

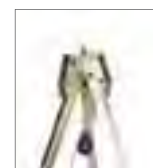

Ferno FDU

Code FWE-FDU 100 (with friction rack) FWE-FDU 200 (without friction rack)

Ideal for personal rescue, emergency escape, rescue operations or specialised rope work as a friction control, double stop descending system. The system gradually releases its load when the handle is moved towards the central position. The double stop mode locks should a panic grab happen but unlocks progressively when the handle is released. The Ferno FDU is available with a friction rack for rescue loads (2 persons) Extensively tested with Donaghys 11 mm Response Static and Response XT Rope and when used with either of these ropes will conform to AS/NZS 4488.1:1997

| | Length | Width | Depth | Weight |
|--------|--------|--------|-------|--------|
| FDU100 | 250 mm | 135 mm | 45 mm | 950 g |
| FDU200 | 250 mm | 135 mm | 45 mm | 730 g |



Dimensions taken with handle in stored position

Sparrow Self Locking Descender

Code VCT2D646

The Sparrow is the result of intensive technical development and research. A built-in braking spur can run the rope through to create more friction and an EBS (Extraordinary Braking System) gives extra breaking capacity in case of emergency. It allows for short ascent and the assembly of reversible haul system.



AB Descender

Code VISC RP810E

Ideal for height access technicians, special forces, rescue specialists, arborists and tower workers who are exiting via a long rope descent. Will take the load of two people and features double stop capabilities. In technical rope access situations it must be used with a type A device or EN353-2 backup device and safety line. Suitable for 10.5 to 11.5 mm rope.

| Length | Width | Depth | Weight |
|--------|-------|-------|--------|
| 200 mm | 79 mm | 35 mm | 440 g |



Anthron Lory

Code ANTH-LORY

A self locking belay device that is suitable for descending, ascending and mechanical advantage hauling systems. The Anthron Lory automatically locks, both when the handle is released or pulled too far reducing the risk of panic pull.

| Rope | Length | Width | Depth | Weight |
|----------------|--------|-------|-------|--------|
| 9 mm - 11.4 mm | 125 mm | 70 mm | 35 mm | 365 g |



Rescue Figure 8

Code VCT L6170001 (Alloy), VCT I61700PO (Stainless Steel)

Available in alloy or stainless steel. Our Rescue Figure 8 with ears is ideal for rescue rappelling or lowering heavy loads. Break load 40 kN. L 172 mm, W 172. Weight 250 g (alloy) Weight 543 g (S/S).



Rescue Figure 9 Anti-Twist Descender

Code VCT RP130

Attachment eye set at 90°C to remain correctly positioned without twisting. Top spike prevents line cross-over on two-rope system. Weight 195 g Break Load 35 kN Rope 9 mm to 13 mm.



CT Chest Ascender Code VCT 2D640D0

It is commonly used as a chest ascender but can also be used for other applications. The design of the ascender ensures smooth and positive ascending as well as good jamming and a patented rope release device.

| Rope | Length | Width | Depth | Weight |
|--------------|--------|-------|-------|--------|
| 8 mm - 13 mm | 104 mm | 77 mm | 36 mm | 140 g |



CT Ascender Simple Code VCT 2D642D0

The Climbing Technology Ascender Simple is designed to be fastened to the harness with a karabiner, maillon rapide or rope 8 mm to 13 mm. The design of the ascender ensures smooth and positive ascending as well as good jamming and a patented rope release device.

| Rope | Length | Width | Depth | Weight |
|--------------|--------|-------|-------|--------|
| 8 mm - 13 mm | 110 mm | 74 mm | 30 mm | 150 g |



Quick Step Boot Ascender

Code VCT 2D654D (right) VCT 2D654S (left)

A light, compact and efficient boot ascender with a patented and unobtrusive cam release system housed within the ascender body. Protective sheath on the underfoot webbing. Fully adjustable for correct positioning. Suitable for 11 mm rope, the Quick Step will grip on dirty or icy ropes. Weight 197 g. Size 83 x 65 mm.



CT Handled Ascenders Code VCT 2D639S5 (left) and VCT 2D639D5 (right)

Each of the Climbing Technology Handled Ascenders has a large opening so they can be easily used with gloves. The handles are padded with a textured rubber compound which is comfortable but firm, providing a non-slip grip.

| Rope | Length | Width | Depth | Weight |
|--------------|--------|-------|-------|--------|
| 8 mm - 13 mm | 190 mm | 95 mm | 35 mm | 215 g |



VCT 2D639S5 (left)

VCT 2D639D5 (right)



ISC Rope Grabs Code VISC RP209A (11-13 mm pip pin)
 VISC RP203 (11-13 mm fixed axle) VISC RP205 (14-16 mm pip pin)
 VISC RP204 (14-16 mm fixed axle)

Available with fixed axle or in-field detachable pip pin axle to allow fitting to the rope at any point. Two sizes available to suit either 11 mm to 13 mm or 14 mm to 16 mm semi-static ropes. EN 353-2 rated.



Removable axle

Fixed axle

EASY MOVE Code VCT 2F713

A lightweight, all in one fall arrester, rope adjuster, rope tool and ascender device that follows your movements and instantly locks in case of fall. The device can be manually adjusted to stop and continue. Suitable for 11 mm rope, the Easy Move will grip on dirty or icy ropes. Weight 190 g.



RED Back up Device Code VISC 890 (popper cord) VISC 891 (fixed tow cord)

The RED is a simple, high performance back up device suitable for use by Rope Access technicians. Tested with 240kg it is suitable for back up rescue loads. The cams positive locking spring means the device is self-parking rather than self-tailing. The RED uses rotational braking so the more it rotates the more friction is built up, providing an automatic brake. Supplied with either a fixed tow cord 'Popper' which will break away in a panic fall or fixed tow cord.

| Rope | Height | Width | Depth | Weight |
|---------------|--------|-------|-------|--------|
| 11 mm - 13 mm | 88 mm | 86 mm | 28 mm | 160 g |



Roll-N-Lock Code VCT 2D625

A compact, ultra-light self jamming pulley with three operational modes: pulley, progress capture pulley and ascender. Ideal for rescue, self-rescue, hauling loads and work manoeuvres where a combination pulley / rope clamp is essential. Openable sheaves with spring operated catch for ascending or hauling. Suitable for 8 to 13 mm rope. Weight 88 g. 20 kN.



Traverse 540 Rescue Belay Code TRAV16-0100 (large) and TRAV16-0200 (small)

The Traverse 540 Rescue Belay is developed specifically to meet the needs of rescue system belays. It is a self-locking device that is able to hold falling loads quickly while limiting the peak force. This well engineered device is easy to rig and the systematic design reduces the risk of improper loading. A built-in release lever reduces the tension on the belay rope, eliminating the need for a release hitch. For use with kernmantle rescue rope. The BCCTR Belay Compliance Drop Test specifications require a 1 m drop of a 280 kg load onto 3 m of 12.7 mm kernmantle rescue rope, with less than 1 m of additional travel and less than 15 kN peak force.

| Code | Rope Size | Weight | MBS |
|---------------------|-------------------|--------|-------|
| TRAV16-0200 (Small) | 10.6 mm - 11.5 mm | 624 g | 40 kN |
| TRAV16-0100 (Large) | 11.5 mm - 13 mm | 624 g | 40 kN |



TRAV16-0100 (Large)

TRAV16-0200 (Small)

CMC Rescue MPD Code CMC333000 (13 mm rope) CMC333010 (11 mm rope)

The MPD is a multi-purpose device that performs all functions for main lines, belay/safety lines, tag lines and hoisting lines and be used to tension high and guiding lines. Training and rigging is simplified and rescue system changeover becomes faster and safer by eliminating switch out and replacement of hardware.

- Variable-friction descent control device for rescue systems and rappels
- High efficiency pulley with an integral rope-locking mechanism for a haul system
- Allows the main line and belay line rigging to be mirror images
- Functions as lowering brake and as ratcheting pulley for raising
- Rescue belay device meets BCCTR Rescue Belay Competency Criteria
- UL Classified to NFPA 1983, General Use Pulley - Auxiliary - Descent Control



ALF™ Locking Pulley

Code VISC RP430 ALF (without becket) VISC RP431 R-ALF (with becket RALF)

A uniquely designed locking pulley system combining an inertia reel/speed sensitive locking system into a grooved pulley wheel. This provides a simple mechanical method of protecting multiple workers in height safety and rescue scenarios or a climb assist system for workers on towers, masts, wind turbines and construction. Uses AS/NZS 4142.3 or EN1891 compliant 11 mm static rope.



Without Becket

With Becket

Rescue Haulers One-Way Locking

One way locking bearings make these Haulers a complete lifting/lowering rescue tool suitable for the most difficult environments and heaviest loads. A one way needle bearing allows the pulley wheel to turn freely in an anti-clockwise direction but will lock in a clockwise direction. A sliding cam can be activated to prevent loss of rope control. CE approved. Meets NFPA G Rated Equipment. Suitable for ropes up to 13 mm. Also available with non locking pulley.

| Code | Description | MBS | Weight |
|------------|--------------------|-------|--------|
| VISC RP702 | Single Non Locking | 45 kN | 600 g |
| VISC RP704 | Single Locking | 45 kN | 600 g |
| VISC RP703 | Double Non Locking | 45 kN | 900 g |
| VISC RP705 | Double Locking | 45 kN | 900 g |



CMC ProSeries CSR Swivel Pulley

For confined space and rescue applications with a locking system that can be unlocked while under load. By eliminating the cam, the pulley system is much more compact when fully collapsed. The compact and integral swivel reduces torque and eliminates the need for multiple connections. Premium components combine to provide exceptional strength..

| Code | Sheave Diameter | Sheave Width | MBS | Weight |
|-----------|-----------------|--------------|---------|--------|
| CMC300345 | 38 mm | 11 mm | 36 kN | 513 g |
| CMC300344 | 38 mm | 11 mm | 36 kN | 408 g |
| CMC300337 | 70 mm | 13 mm | 53.3 kN | 1.4 kg |
| CMC300336 | 70 mm | 13 mm | 52.5 kN | 1 kg |



CMC Rescue S/S Swivel Pulleys

The swivel pulley is ideal for high anchor points or tripods and the overall length is minimised by combining the swivel with the pulley. The 51 mm x 13 mm stainless steel sheave on the single pulley permits use with rope or wire cable. Pivoting side plate opens without having to disconnect the pulley from the anchor, allowing rope to be quickly inserted or removed.

| Code | Sheave Diameter | Sheave Width | MBS | Weight |
|-----------|------------------------|--------------|---------|--------|
| CMC300431 | Single Stainless Steel | Light Use | 32.7 kN | 320 g |
| CMC300430 | Single Stainless Steel | General Use | 39.4 kN | 320 g |
| CMC300432 | Double Aluminium | General Use | 43.5 kN | 414 g |



ISC Prusik Minding Pulleys

ISC Prusik Minding Pulleys are designed for heavy duty rescue, rigging and hauling systems. The full range consists of sizes small, medium and large. Each size is available in a single or double pulley configuration in aluminium or stainless steel.

Alloy Plate with Alloy Wheel

| Code | Description | MBS | Rope | Sheave | Weight |
|--------------|----------------------|-------|-------|--------|--------|
| VISC RP060A1 | Small Single | 40 kN | 13 mm | 50 mm | 200 g |
| VISC RP061A1 | Small Double | 40 kN | 13 mm | 50 mm | 340 g |
| VISC RP063A1 | Medium Single | 50 kN | 13 mm | 62 mm | 280 g |
| VISC RP065A1 | Medium Single Becket | 50 kN | 13 mm | 62 mm | 300 g |
| VISC RP064A1 | Medium Double | 50 kN | 13 mm | 62 mm | 500 g |
| VISC RP066A1 | Large Single | 70 kN | 16 mm | 75 mm | 440 g |
| VISC RP067A1 | Large Double | 70 kN | 16 mm | 75 mm | 760 g |



Alloy



Stainless Steel

Stainless Steel with Stainless Steel Wheel

| Code | Description | MBS | Rope | Sheave | Weight |
|--------------|----------------------|-------|-------|--------|--------|
| VISC RP060D1 | Small Single | 40 kN | 13 mm | 50 mm | 398 g |
| VISC RP061D1 | Small Double | 40 kN | 13 mm | 50 mm | 674 g |
| VISC RP063D1 | Medium Single | 50 kN | 13 mm | 62 mm | 584 g |
| VISC RP065D1 | Medium Single Becket | 50 kN | 13 mm | 62 mm | 584 g |
| VISC RP064D1 | Medium Double | 50 kN | 13 mm | 62 mm | 1036 g |
| VISC RP066D1 | Large Single | 70 kN | 16 mm | 75 mm | 896 g |
| VISC RP067D1 | Large Double | 70 kN | 16 mm | 75 mm | 1626 g |

OG1 Prusik Minding Pulley

The OG1 Prusik Minding Pulley is an invaluable aid for heavy duty industrial rigging or rescue operations. It has an impressive 36 kN load rating with a side opening plate that allows you to access the 51 mm x 13 mm sheave without disconnecting the pulley from its anchor. Connection point can hold up to three 12 mm karabiners. Made from high grade anodised aluminium and stainless steel.

| Rope | Length | Width | Depth | Weight |
|---------------|--------|--------|-------|--------|
| 11 mm - 13 mm | 180 mm | 120 mm | 47 mm | 950 g |



CT Mobile Single Pulley Small Code VCTL6220003

A light alloy pulley with oscillating side plates. The sheave is mounted on self lubricating bushings. Rope 13mm.

| Rope | Length | Width | Depth | Weight | Break Load |
|--------|--------|-------|-------|--------|------------|
| <13 mm | 74 mm | 44 mm | 33 mm | 94 g | 22 kN |



CT Mobile Twin Pulley with Becket Code VCT2P62600

Light alloy double pulley with oscillating side plates. Twin sheaves mounted on heavy duty ball bearings. Up to three connectors can be hooked in to the large eyelet plus one connector into the Becket.

| Rope | Length | Width | Depth | Weight | Break Load |
|--------|--------|-------|-------|--------|------------|
| <13 mm | 152 mm | 70 mm | 48 mm | 345 g | 50 kN |



CT Mobile Single Pulley Code VCT2P62400

Large light weight alloy pulley with oscillating side plates. Single sheave mounted on heavy duty ball bearings. Up to three connectors can be hooked in to the large eyelet.

| Rope | Length | Width | Depth | Weight | Break Load |
|--------|--------|-------|-------|--------|------------|
| <13 mm | 124 mm | 70 mm | 28 mm | 200 g | 32 kN |



CT Mobile single Pulley with Becket Code VCT2P62500

Large light weight alloy pulley with oscillating side plates. Single sheave mounted on heavy duty ball bearings. Up to three connectors can be hooked in to the large eyelet plus one connector into the Becket.

| Rope | Length | Width | Depth | Weight | Break Load |
|--------|--------|-------|-------|--------|------------|
| <13 mm | 147 mm | 70 mm | 48 mm | 210 g | 32 kN |



Forged Alloy Swivel Code VCTL7950003

This lightweight Forged Alloy Swivel with precision bearings helps in the prevention of severe rope twist. Each eyelet will fit three connectors up to 12 mm diameter. Ideally used in tripod rescue scenarios or hauling systems.

| Length | Width | Depth | Weight | Break Load |
|--------|-------|-------|--------|------------|
| 113 mm | 57 mm | 30 mm | 170 g | 40 kN |



Anchor Plates

Code VCTL6370303 (4 holes) VCTL6370503 (8 holes) VISC RP320A (15 holes)

Anchor Plates allow you to create and organise your anchor systems safely. These Anchor Plates are made from high grade aluminium alloy. Anchor Plates are available in four, eight or fifteen hole options.

| | Length | Width | Weight | Breaking Load | Hole Diameter |
|----------|---------|--------|--------|---------------|---------------|
| 4 Holes | 96.5 mm | 83 mm | 63 g | 36 kN | 20 mm |
| 8 Holes | 149 mm | 98 mm | 136 g | 45 kN | 20 mm |
| 15 Holes | 249 mm | 150 mm | 471 g | 55 kN | 19 mm |



Maillon Rapide Standard

The Maillon Rapide Standard is extremely strong when loaded along the long axis. Suitable for anchor and rigging connections.



| Code | Size mm | Length mm | Gate Opening mm | Thread Diameter mm | Work Load kg |
|------|---------|-----------|-----------------|--------------------|--------------|
|------|---------|-----------|-----------------|--------------------|--------------|

Standard - Zinc Plated Steel

| | | | | | |
|-----------|----|-------|-----|----|------|
| VMR STS04 | 4 | 39.5 | 5.5 | 6 | 180 |
| VMR STS06 | 6 | 57 | 7.5 | 9 | 400 |
| VMR STS08 | 8 | 74 | 11 | 11 | 700 |
| VMR STS10 | 10 | 89 | 12 | 13 | 1100 |
| VMR STS12 | 12 | 104.5 | 15 | 15 | 1500 |

Standard - Stainless Steel

| | | | | | |
|------------|----|-------|----|----|------|
| VMR STSS08 | 8 | 74 | 11 | 11 | 1100 |
| VMR STSS10 | 10 | 89 | 12 | 13 | 1800 |
| VMR STSS12 | 12 | 104.5 | 15 | 15 | 2500 |

Standard - High Strength Alloy

| | | | | | |
|-----------|----|----|----|----|------|
| VMR STA10 | 10 | 89 | 12 | 13 | 2500 |
|-----------|----|----|----|----|------|

Maillon Rapide Pear

Ideal in situations where a three-way load is exerted. Also used for climbing rope, anchors and harness-to-chest harness connectors.



| Code | Size mm | Width mm | Length mm | Gate Opening mm | Thread Diameter mm | Work Load kg |
|------|---------|----------|-----------|-----------------|--------------------|--------------|
|------|---------|----------|-----------|-----------------|--------------------|--------------|

Pear Shaped – Zinc Plated Steel

| | | | | | | |
|----------|----|----|-----|------|----|-----|
| VMR PS08 | 8 | 53 | 100 | 17.5 | 11 | 480 |
| VMR PS10 | 10 | 63 | 118 | 20.5 | 13 | 720 |

Maillon Rapide Twist

Fitted with a 90 degree twist, the Maillon Rapide Twist is ideal for smoother PPE connections in industrial safety, fall arrest systems, work restraint, work positioning, rope access as well as in mountaineering and climbing.



| Code | Size mm | Width mm | Length mm | Gate Opening mm | Thread Diameter mm | Break Strength kN |
|------|---------|----------|-----------|-----------------|--------------------|-------------------|
|------|---------|----------|-----------|-----------------|--------------------|-------------------|

Twist Zinc Plated Steel

| | | | | | | |
|-----------------------------|---|----|----|------|----|------|
| VMR STSTW07 (Standard) | 7 | 33 | 66 | 16 | 10 | 27.5 |
| VMR LOSTW08 (Large Opening) | 8 | 36 | 88 | 17.5 | 11 | 32 |

Wire Connectors

Code VCT I70908PO (80 mm), VCT I70910PO (100 mm), VCT I70914PO (140 mm)

Available in three different sizes to suit 80 mm, 100 mm or 140 mm scaffold or pipe. Constructed from one-piece stainless steel giving it a high overall strength 15 kN.



Maillon Rapide Delta

Ideal in situations where a three-way load is exerted. Also used for climbing rope, anchors and harness-to-chest harness connectors.



| Code | Size mm | Width mm | Length mm | Gate Opening mm | Thread Diameter mm | Work Load kg |
|------|---------|----------|-----------|-----------------|--------------------|--------------|
|------|---------|----------|-----------|-----------------|--------------------|--------------|

Delta - Zinc Plated Steel

| | | | | | | |
|----------|----|------|-----|-----|----|------|
| VMR DS04 | 4 | 35.5 | 40 | 5.5 | 6 | 100 |
| VMR DS06 | 6 | 47 | 56 | 7.5 | 9 | 250 |
| VMR DS08 | 8 | 56 | 73 | 10 | 11 | 550 |
| VMR DS10 | 10 | 66 | 87 | 12 | 13 | 900 |
| VMR DS12 | 12 | 75 | 104 | 15 | 15 | 1100 |

Delta - Stainless Steel

| | | | | | | |
|-----------|----|----|----|----|----|------|
| VMR DSS10 | 10 | 66 | 87 | 12 | 13 | 1250 |
|-----------|----|----|----|----|----|------|

Delta - High Strength Alloy

| | | | | | | |
|----------|----|----|----|----|----|-----|
| VMR DA10 | 10 | 66 | 87 | 12 | 13 | 350 |
|----------|----|----|----|----|----|-----|

Maillon Rapide Large Opening

The wider mouth opening makes connecting easier. Suitable for anchor and rigging connections.



| Code | Size mm | Length mm | Gate Opening mm | Thread | Work Load kg |
|------|---------|-----------|-----------------|--------|--------------|
|------|---------|-----------|-----------------|--------|--------------|

Large Opening – Zinc Plated Steel

| | | | | | |
|-----------|----|-------|------|----|-------|
| VMR LOS07 | 7 | 79 | 16 | 10 | 500 |
| VMR LOS08 | 8 | 88 | 17.5 | 11 | 650 |
| VMR LOS10 | 10 | 105.5 | 20.5 | 13 | 1 000 |
| VMR LOS12 | 12 | 124 | 23.5 | 15 | 1250 |
| VMR LOS16 | 16 | 161 | 29.5 | 19 | 2500 |

Large Opening – Stainless Steel

| | | | | | |
|------------|----|-------|------|----|------|
| VMR LOSS08 | 8 | 88 | 17.5 | 11 | 980 |
| VMR LOSS10 | 10 | 105.5 | 20.5 | 13 | 1600 |
| VMR LOSS12 | 12 | 124 | 23.5 | 15 | 2200 |

Maillon Rapide C

Commonly used when connecting sit and chest harnesses.



| Code | Size mm | Length mm | Gate Opening mm | Thread Diameter mm | Work Load kN |
|------|---------|-----------|-----------------|--------------------|--------------|
|------|---------|-----------|-----------------|--------------------|--------------|

C Shape – Zinc Plated Steel

| | | | | | |
|----------|----|----|----|----|-------|
| VMR CS10 | 10 | 86 | 10 | 13 | 10 kN |
|----------|----|----|----|----|-------|

C Shape - High Strength Alloy

| | | | | | |
|----------|----|----|----|----|-------|
| VMR CA10 | 10 | 86 | 10 | 13 | 10 kN |
|----------|----|----|----|----|-------|

Steel Screw Gate Karabiner

Code VAUA TN 61A

A compact D-shape, steel screw gate karabiner. Slender design locking eye prevents rope snag when clipping in and out.

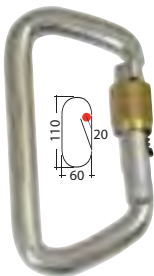

| Weight | Diameter Bar | | | |
|--------|--------------|-------|-------|-------|
| 220 g | 12 mm | 60 kN | 12 kN | 15 kN |

Steel Screw Gate Karabiner

Code VCT A455TBZ0

This high strength, hardened zinc plated steel karabiner has a useful wide opening screw gate entry. New snag free nose and gate.

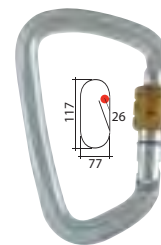

| Weight | Diameter Bar | | | |
|--------|--------------|-------|-------|-------|
| 253 g | 13 mm | 50 kN | 15 kN | 20 kN |

Steel Screw Gate Karabiner

Code VCT A428TOZO

Classic screw gate karabiner with very high break strength and optional captive bar. Individually tested. New snag free nose and gate.

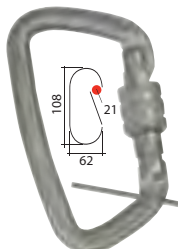

| Weight | |
|--------|-------|
| 178 g | 50 kN |

Steel Screw Gate Karabiner

Code VAUA TM11A

Classic D-shape, steel screw gate karabiner. Perfect for most applications including rescue, industrial, caving, group use or setting anchors for climbing.

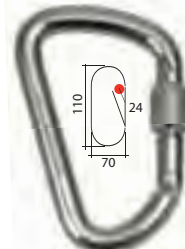

| Weight | Diameter Bar | | | |
|--------|--------------|-------|-------|-------|
| 230 g | 12 mm | 35 kN | 10 kN | 10 kN |

Steel Screw Gate Karabiner

Code VISC KH311SG

An economical, oval, screw gate karabiner with a 25 kN capacity.

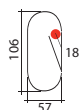

| Weight | |
|--------|-------|
| 160 g | 25 kN |

Steel Screw Gate Karabiner

Code VAUA TX11S

Large pear shaped steel screw gate karabiner with captive bar and large offset gate opening. The large, easy to use gate opening is perfect for clipping scaffold or ladder steps.

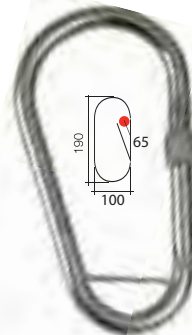

| Weight | Diameter Bar | | | |
|--------|--------------|-------|-------|------|
| 460 g | 13 mm | 25 kN | 12 kN | 6 kN |

Steel Triplock Karabiner

Code VCT A595TBBZ0

This steel karabiner is made of hardened zinc plated steel for high performance and enhanced safety. It has a triple action twist lock entry with wide opening gate and optional captive bar. New snag free nose and gate.

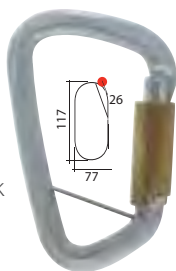

| Weight | Diameter Bar | | | |
|--------|--------------|-------|-------|-------|
| 267 g | 13 mm | 50 kN | 15 kN | 15 kN |

Steel Triplock Karabiner

Code VCT A430TBZ0

A compact, lightweight, hardened steel karabiner with a 50 kN rating and triple lock gate. New snag free nose and gate. Optional captive bar provided.

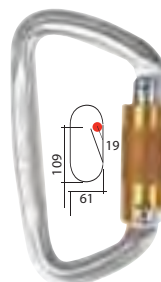

| Weight | | | |
|--------|-------|-------|-------|
| 195 g | 50 kN | 15 kN | 15 kN |

Steel Triplock Karabiner

Code VISC KH307SSP1

Large steel triplock karabiner with large gate opening which is ideal for attaching to larger anchors. Optional captive bar provided.

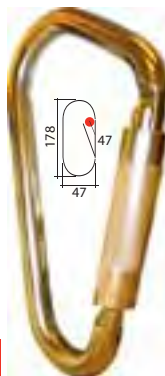

| Weight | |
|-------------|-------|
| steel 330 g | 40 kN |

Steel Swivel Triplock Karabiner

Code VISC KH260SS11

A steel triplock karabiner with a fall indicator. Swivel feature eliminates potential twisting of line.

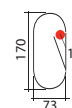

| Weight | | |
|--------|-------|-------|
| 225 g | 35 kN | 19 kN |

Stainless Steel Triplock Karabiner

VCT146500PO ASS Stainless Steel Gate. VCT146500PO BSS Brass Gate

Available with a stainless steel gate or a knurled brass gate, (S/S gate shown) This combination provides an extremely versatile product for use in hostile environments. Supplied with captive bar.

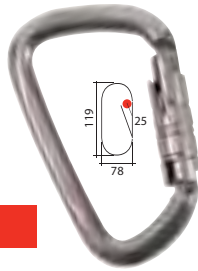

| Weight | |
|--------|---|
| 278 g | 35 kN |

Stainless Steel Triplock Karabiner

VISC KH307SSP3

Large stainless steel triplock karabiner with large gate opening. The large gate opening is ideal for attaching to larger anchors. Optional captive bar provided.

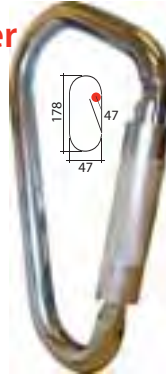

| Weight | |
|--------|---|
| 330 g | 40 kN |

Alloy Triplock Karabiner

Code VCT2C4650CXSACT001

A large, alloy, triplock karabiner supplied with a captive bar. Wide opening gate with catch free locking and an excellent breaking strength. Made from anodised light alloy.

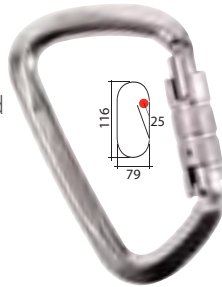

| Weight | | | |
|--------|---|---|---|
| 101 g | 30 kN | 8 kN | 11 kN |

Alloy Triplock Karabiner

Code VCT L4131201

A lightweight, alloy, triple action karabiner with a pear shaped profile that allows a large 29 mm gate opening.

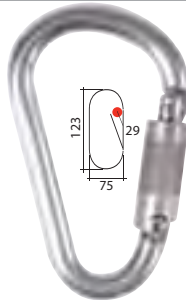

| Weight | | | |
|--------|---|---|---|
| 98 g | 27 kN | 9 kN | 7 kN |

Alloy Triplock Karabiner

Code VCT 2C42300

A lightweight, c-shaped alloy karabiner with triplock gate opening. Ideal for situations where a three way load is exerted.

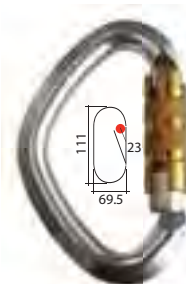

| Weight | | |
|--------|---|---|
| 133 g | 20 kN | 15 kN |

Stainless Steel Swivel Triplock Karabiner

VISC KH251SSI1

A stainless steel triplock karabiner with a fall indicator. Swivel feature eliminates potential twisting of line.



| Weight | | |
|--------|---|---|
| 330 g | 35 kN | 19 kN |

Alloy Screw Gate Karabiner

Code VAUA KX11AM

This is a great alloy rescue karabiner. Features lightweight alloy design, large D-shape with wide gate opening and large, easy to use screw gate barrel.

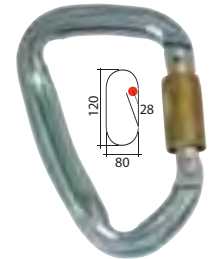

| Weight | | | |
|--------|---|---|---|
| 110 g | 36 kN | 10 kN | 16 kN |

Alloy Triplock Karabiner

Code VCT L5300001

Extra light, drop forged alloy karabiner with triple action gate opening.

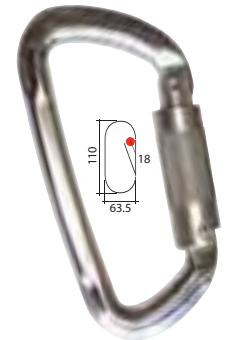

| Weight | |
|--------|---|
| 79 g | 30 kN |

Alloy Triplock Karabiner

Code VCT 2C3390

A lightweight alloy karabiner with triplock entry. Manually operated, spring loaded captive bar. Snag free system for clean connections.

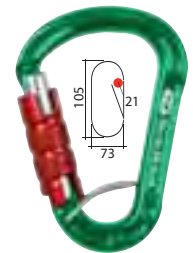

| Weight | | | |
|--------|---|---|---|
| 83 g | 23 kN | 10 kN | 8 kN |

Alloy Double Action Hook

Code VCT 2C37300

Lightweight and durable with a stainless steel insert for wear proof use on wire cable. Easy handling with gloves.

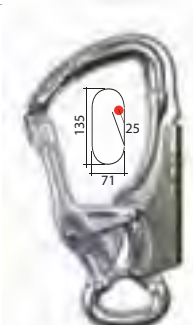

| Weight | | | |
|--------|---|---|---|
| 127 g | 30 kN | 12 kN | 12 kN |

Harnesses

Using the right equipment at the right time could make the difference between life or death. Unfortunately, not all gear is created equal — including harnesses.

We've cut through the clutter and selected a complete suite of quality harnesses that will provide a solution for any application where your safety's at risk.

Ferno's priority is to produce products that are consistently high in quality and reliability. To achieve this, all Ferno-made harnesses and lanyards are made from quality materials and manufactured according to AS/NZS ISO9001:2000 Quality Assurance guidelines.

Harness designs undergo Ferno's extensive R&D process and tested not only for strength and durability but also for comfort. Testing occurs in Ferno's testing facilities which is one of six NATA-accredited testing laboratories in Australia certified to conduct testing on AS/NZS1891.1



Ferno Hardpoint Full Body Harness Range Code VHI HP (standard) VHI HP ASC (ascender)

The Ferno Hardpoint provides all the comfort and benefits of the standard Centrepoint 2 range however the Ferno Hardpoint replaces the front web belay loop with a hard connection point. For even greater versatility there are an abundance of hard and soft connection points spaced across the waist and back pads to attach additional hardware and gear.

Features

- Front hard connection point
- Versatile design allows use for a multitude of applications
- Offset (cranked) pole strap attachment points
- Quick connect buckles on waist and legs
- Front and rear free fall arrest D-ring attachment points
- Limited free fall arrest attachment point
- 8 additional connection points for hardware and gear
- Extra wide, padded waist and leg straps for added comfort when hanging or working for long periods of time
- Removable moisture wicking 3D mesh back pad provides unrivalled shoulder and neck protection
- Fully adjustable rear leg risers to ensure best fit
- Australian Standards approved AS/NZS 1891.1:2007
- Available XS, S-M, M-L, XL. Conditions apply for XS and XL
- Supplied standard with all alloy hardware
- Flame proof and antistatic webbing

Optional Features

- All stainless steel hardware
- Retrofit alloy ascender kit for increased mobility when ascending

| Work Positioning | Fall Arrest | Confined Space | Rescue | Rope Access |
|------------------|-------------|----------------|--------|-------------|
| • | • | • | • | • |

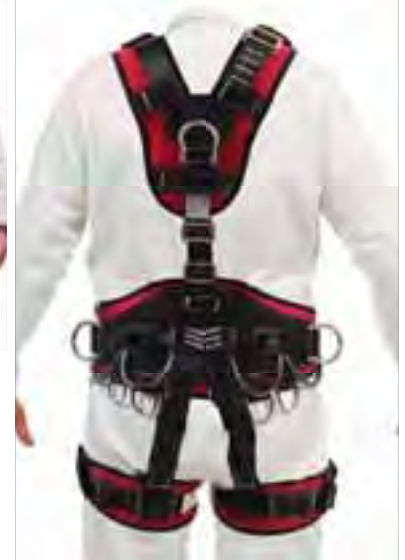

Retrofit Ascender kit



Quick connect buckles

Ferno Centrepoint 2 Full Body Harness Range

Code FHI CEN FB 2 (standard) VHI CEN FB 2 A (ascender) VHI CEN FB 2 BS (battery & self rescue strap)

The Ferno Centrepoint 2 Full Body Harness is a versatile and comfortable harness that can be used for a multitude of rescue applications.

Features

- Versatile design allows use for a multitude of applications
- Offset (cranked) pole strap attachment points
- Confined space retrieval attachment points
- Quick connect buckles on waist and legs
- Front and rear free fall arrest D-ring attachment points
- Limited free fall arrest attachment point
- Gear loops for storing excess hardware and gear
- Extra wide, padded waist and leg straps for added comfort when hanging or working for long periods of time
- Removable moisture wicking 3D mesh back pad provides unrivalled shoulder and neck protection
- Fully adjustable rear leg risers to ensure best fit
- Australian Standards approved AS/NZS 1891.1:2007
- Available XS, S, M, L, XL. Conditions apply for XS and XL
- Supplied standard with all alloy hardware
- Flame proof and antistatic webbing

Optional Features

- All stainless steel hardware
- Retrofit alloy ascender kit for increased mobility when ascending

| Work Positioning | Fall Arrest | Confined Space | Rescue | Rope Access |
|------------------|-------------|----------------|--------|-------------|
| • | • | • | • | • |



Retrofit Ascender kit

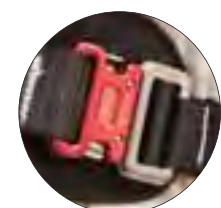

Quick connect buckles

Ferno Centrepoint Full Body Harness Range

Code FHI CEN FB (standard) VHI CEN FB CS (con space) VHI CEN FB CS BS (con space & battery strap)

Features

- Versatile design allows use for a multitude of applications
- Pole strap attachment points
- Front and rear free fall arrest D-ring attachment point
- Limited free fall arrest attachment point
- Extra wide, padded, waist and leg straps for added comfort when hanging or working for long periods of time
- Gear loops around the waist for storing excess hardware and gear
- Fixed, elasticised leg risers
- Supplied standard with steel hardware
- Australian Standards approved AS/NZS 1891.1:2007
- Available XS, S, M, L, XL. Conditions apply for XS and XL

Optional Features

- Flame proof and antistatic webbing
- Confined space retrieval attachment points
- Battery and self rescuer attachment strap
- All stainless steel or alloy hardware
- Retrofit alloy ascender kit for increased mobility when ascending

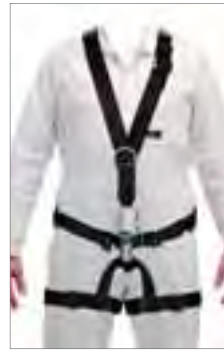

Retrofit
Ascender kit

| Work Positioning | Fall Arrest | Confined Space | Rescue | Rope Access |
|------------------|-------------|----------------|--------|-------------|
| • | • | • | • | • |

Centrepoint Tactical Full Body Black VHI CEN FB M BLK

With all the key features of our popular Centrepoint Harness, the Centrepoint Black is ideal for any tactical response operation.

Features

- Versatile design allows use for a multitude of applications
- Pole strap attachment points
- Front and rear free fall arrest D-ring attachment point
- Limited free fall arrest attachment point
- Extra wide, padded, waist and leg straps for added comfort when hanging or working for long periods of time
- Gear loops around the waist for storing excess hardware and gear
- Fixed, elasticised leg risers
- Supplied standard with steel hardware
- Australian Standards approved AS/NZS 1891.1:2007
- Available XS, S, M, L, XL. Conditions apply for XS and XL

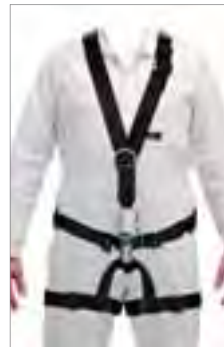

| Work Positioning | Fall Arrest | Confined Space | Rescue | Rope Access |
|------------------|-------------|----------------|--------|-------------|
| • | • | • | • | • |



Vertical Challenge Full Body Code VHS CHALLENGE FB

The purpose designed elasticised waist strap make the Vertical Challenge a standout for ease of donning and fitment to all body shapes. Ideal for Industrial use the Vertical Challenge Full Body is also CASA standards approved.

Features

- Rear and front free fall arrest attachment point
- Fall arrest points are height adjustable for situational requirements
- Quick connect buckles on legs
- Elasticised waist strap ensures all body size fit
- Simplistic design and shape allows easy donning
- Australian Standards approved AS/N ZS 1891.1:2007
- Available in S/M or M /L. Conditions apply for XS and XL

Optional Features

- Flame proof and antistatic webbing
- All stainless steel hardware

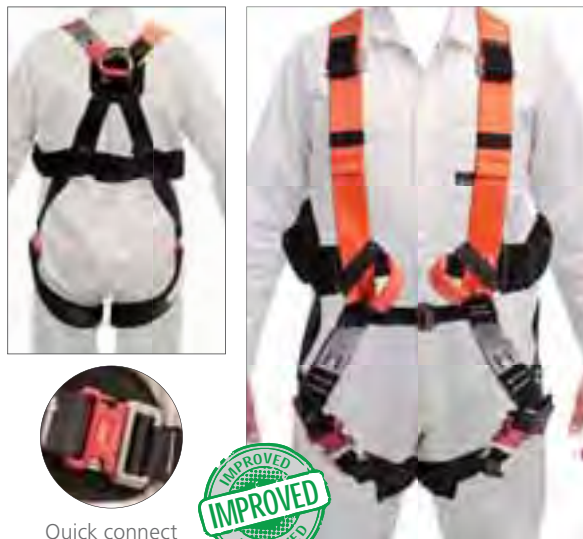

Quick connect buckles



| Work Positioning | Fall Arrest | Confined Space | Rescue | Rope Access |
|------------------|-------------|----------------|--------|-------------|
| | • | | • | • |

Hi-Safe FH17 Full Body Harness Code VFM-FH17

Features

- Front free fall arrest attachment points
- Rear free fall arrest D-ring attachment point
- Thread through, adjustable leg straps
- Breathable rear mesh panel keeps the harness in shape
- Fully adjustable, multi size fit
- Easy to don jacket style design
- Australian Standards approved AS/NZS 1891.1:2007
- Optional flame proof and antistatic webbing
- Customised labelling available - conditions apply



| Work Positioning | Fall Arrest | Confined Space | Rescue | Rope Access |
|------------------|-------------|----------------|--------|-------------|
| | • | | | |

Ferno Centrepont Sit Harness

Code VHI CEN SIT (basic), VHI CEN SIT BS (with optional accessories)

Features

- Pole strap attachment points
- Wide, padded, waist and leg loops for added comfort when hanging or working for long periods of time
- Gear loops around the waist for storing hardware and gear
- Fully adjustable rear leg risers to ensure best fit
- Versatile design allows use for a multitude of applications
- User friendly and lightweight design
- Flame proof and antistatic webbing
- Australian Standards approved to AS/NZS 1891.1:2007
- Available XS, S, M, L, XL. Conditions apply for XS and XL

Optional Features

- Battery and self rescuer attachment strap
- Flame-proof/anti-static webbing



Inspection Program

It is recommended by Australian Standards that harnesses be discarded at least 10 years from date of manufacture, if no damage has been sustained in the meantime. Inspection and maintenance is recommended every 6 months in accordance with manufacturer's recommendations and withdrawn from use if not deemed to be suitable for continued use by a competent person. Refer to AS/NZS1891.4: 2009 for further guidance on harness selection, use and maintenance.

Harness Inspection

Before and after each use, inspect your harness for any signs of ageing or damage.

1. Run your hands over the straps and ensure all webbing is free from abrasion, dirt, cuts, tears, burns and felt pen marks, overspray, chemical and UV damage, worn or crushed fibres, discolouration and knots.

2. Check the harness' sewn areas for damaged stitch patterns, broken or loose threads, heat damage or stretching.

3. Check each buckle, D-ring or attachment point is in perfect working condition with no distortion, cracking, corrosion, rust, abrasion or missing components.

4. Ensure all tags are present and clearly legible. If any defects are found during this checking process, you should remove the harness from service immediately and mark it unsafe. If more than 10% wear is determined, tag the unit and remove it from service.

Australian Standards AS/NZS1891.4: 2009 recommend harnesses be discarded at least 10 years from date of manufacture, if no damage has been sustained in the meantime. Inspection and maintenance is recommended every 6 months and withdrawn from use if not deemed to be suitable for continued use by a competent person.



Ferno Flashpoint Sit Harness *Code VHI FLASHP*

The Ferno Flashpoint Sit Harness has been a favourite of State Emergency Services in Australia for many years. It is an extremely strong, lightweight and comfortable harness to hang in. This is due to its extra thigh/sit strap that spreads the load more evenly across the body, reducing the strain on the leg straps and waist belt. The twin belay loops provide strength and orientates the descender in line with the body, instead of at right angles. The Ferno Flashpoint Sit Harness can also be combined with a chest harness to provide extra support and security. One size fits all.



Ferno Rappel Belt *Code VAI RAPPEL*

The Ferno Rappel Belt is designed for situations where an instant evacuation or extrication is the only resort. It is manufactured from quality 44 mm webbing and plated steel components.

Key Features

- Secure sliding bar buckle for ultra fast donning
- Steel D-ring attachment point
- Velcro loop keeps D-ring stowed until required
- Velcro keeps the web belt end neatly secured, preventing any possibility of entanglement or slippage
- Rated to 6 kN - restraint fall



Spreader Bar *Code VAI SPREADER SHA*

Used in confined space situations and rescue scenarios. Attaches to confined space pick up points on harness shoulder straps. AS/NZS 1891.1:2007 approved.



Patient Lifting Sling *Code VRES PAT LIFT+*

Code VRES PAT LIFT+

Ideal for retrieval of victims trapped in locations where time and rescue is of the essence. Simple to apply and fully adjustable in confined and difficult situations. Seat and leg loops hold victim securely.



Vertical Rescue Triangular Harness *Code VRES TRI HARN*

The Vertical Rescue Triangular Harness is a simple yet robust patient lifting sling designed for all forms of rapid vertical extrications. The simple design allows the harness to be applied to the patient easily and quickly compared to other full body rescue harnesses. The Vertical Rescue Triangular Harness secures the patient during a lift. This harness is not suitable for patients with suspected spinal injuries.



Arresta Static Kernmantle Rope

Arresta Static Kernmantle Rope is a fully imported, economical rope constructed with a braided polyester outer surrounding a nylon kernmantle core. Available in a variety of colour ways in 11 mm, 13 mm and 16 mm diameter. Meets AS 4142.3 and EN 1891:1998



Arresta Hi-Vis Reflective Rope

Arresta Static Kernmantle Rope is a fully imported, economical rope constructed with a braided polyester outer surrounding a nylon kernmantle core. For night and day safety, available in high visibility colour with reflective silver fleck. Available in 11 mm diameter. Meets AS 4142.3 and EN 1891:1998



Response® XT

Access Line

Response XT has been designed with your ultimate safety in mind, certified to AS/NZS 4142.3, ANSI Z-133 and EN 1981 standards. Donaghys Response XT is the premium safety and rescue line and allows quick access for any emergency.



- Low stretch, high strength
- Heat set
- Quick access
- Excellent knot holding

| Working Load | 80 kg | 375 kg | 3740 kg |
|--------------------|-------|--------|---------|
| Elastic Elongation | 1.4% | 6.1% | 25% |

| Size (Dia) | Weight/100 m | Break Strength | SWL | Reel Length |
|------------|--------------|----------------|--------|-------------|
| 11 mm | 9 kg | 3475 kg | 347 kg | 200 m |
| 13 mm | 11 kg | 4750 kg | 475 kg | 200 m |

Response® Static Line

Access Line

Response Static Line is characterised as supple for handling, coiling and providing superior feel and control when used with certified hardware in any abseil, belay or static descent application. AS/NZS 4142.3 and EN1891 compliant. Available in various colour options.



| Size (Dia) | Weight/100 m | Break Strength | SWL | Reel Length |
|------------|--------------|----------------|--------|-------------|
| 6 mm | 3 kg | 1100 kg | 110 kg | 100 m |
| 9 mm | 6 kg | 2250 kg | 225 kg | 200 m |
| 11 mm | 9 kg | 3475 kg | 347 kg | 200 m |
| 13 mm | 11 kg | 4750 kg | 475 kg | 200 m |
| 16 mm | 16.5 kg | 6900 kg | 690 kg | 100 m |

Rhino

Rigging/Lowering Line

Rhino is a 100% polyester double braid. Designed for high strength with low stretch, Rhino offers the ultimate in rigging or lowering lines.



- Low stretch
- Easy to splice
- Excellent handling and abrasion resistance
- UV stable
- Designed to run easily through rigging hardware

| % of Break Strength | | 10% | 20% | 30% |
|---------------------|-------|------|------|------|
| Elastic Elongation | 12 mm | 1.8% | 2.6% | 3.3% |
| Elastic Elongation | 16 mm | 1.8% | 2.6% | 3.3% |

| Size (Dia) | Weight/100 m | Break Strength | SWL | Reel Length |
|------------|--------------|----------------|--------|-------------|
| 12 mm | 10.4 kg | 4570 kg | 760 kg | 100 m |
| 16 mm | 21 kg | 5530 kg | 920 kg | 100 m |

Three Strand Polyester Rope

Rigging/Lowering Line



A spliceable three strand, high tenacity, abrasion resistant polyester. This rope is suitable for a multitude of applications including roofing restraint, general lift and tie down purposes.

- AS4142:3 1993 compliant

| Size (Dia) | Reel Length | Standard Breakforce | Base Colour | Marker Yarn | No. Strands |
|------------|-------------|---------------------|---------------|-------------|-------------|
| 12 mm | 250 m | 2280 kg | Natural White | Blue | 3 |
| 16 mm | 250 m | 4100 kg | Natural White | Blue | 3 |

Standard-Prus

Prusik Line



A double braided high tenacity nylon Prusik or accessory line which can be used in all general applications.

- Easy handling and knot holding
- Suitable for general applications

Spectra-Speed

Prusik Line



Approved for use as Prusik material climbing hitches. Spectra-Speed uses a high tenacity polyester braided cover over a braided Spectra® 900 core.

- Easy to splice / no stretch
- Meets ITCC climbing competition rules
- Certified to Australian Standard AS/NZS 4142.3

Armour-Prus

Prusik Line



At long last, a prusik line that will last. A unique cover blend of Technora and polyester acts like armour over a core of lightweight Spectra 900. Donaghys Spectra® core incorporates a world first safety feature of twin Kevlar strands preventing the core from being cut or melted completely in the unlikely event of a cover failure.

- Very low stretch and easy to splice
- Technora is rated 234°C higher than standard polyester

| Product | Size (Dia) | Break Strength | Reel Length |
|---------------|------------|----------------|-------------|
| Standard-Prus | 6 mm | 1100 kg | 100 m |
| Standard-Prus | 8 mm | 1900 kg | 100 m |
| Spectra-Speed | 6 mm | 1570 kg | 100 m |
| Spectra-Speed | 8 mm | 2800 kg | 100 m |
| Spectra-Speed | 10 mm | 4300 kg | 100 m |
| Armour-Prus | 8 mm | 2800 kg | 25 m |
| Armour-Prus | 10 mm | 4300 kg | 25 m |

Anacond Dynamic 10.2 mm

Code VCT7W1500A60 (60 m), VCT7W1500A70 (70 m), VCT7W1500A80 (80 m)

Dynamic 10.2 mm all round abseil rope with great strength and an industry leading 65 grams per metre.



- Dynamic elongation: 33 %
- Material: Water-resistant Polyamide
- EN 892: 2004 compliant
- Length: 60 m, 70 m, 80 m
- 2 x Dry water repellent treatment
- Static elongation: 7.9%

Rope Safety Lines



Hi-Safe Rope Safety Lines are available in 11 mm sewn end kernmantle rope in a variety of lengths. All safety lines are finished with a thimble eye and can be supplied with an array of hardware options or supplied with thimble only. Break force in excess of 25 kN.

| Code | Product Detail |
|--------------------------------|--------------------------------------|
| HS-NARROPLAN H (+ length in m) | Kernmantle with double action hook |
| HS-NARROPLAN K (+ length in m) | Kernmantle with screw gate karabiner |
| HS-NAR ROP LAN (+ length in m) | Kernmantle rope only |

Note other lengths and end fittings on request.



CMC Rescue Prusik Cord and Load Release Hitch Cord

Code CMC293017, CMC293037, CMC293018, CMC293038 and CMC293039

CMC Rescue Prusik Cord has the right balance of suppleness for reliable activation, but is not so soft that it wears out rapidly. Made of nylon with a torque free kernmantle construction, it comes in solid colours to differentiate between cords designed for prusik hitches and climbers' accessory cords. Two colour choices in the 7 mm and 8 mm diameters. The 9 mm diameter is the size preferred by rescuers who use a load releasing hitch. These cords are available by the foot or spool.



| | Diameter | Colour | MBS | Spool Length |
|-----------|----------|--------|-------|-----------------|
| CMC293017 | 7 mm | Yellow | 9 kN | 366 m (1200 ft) |
| CMC293037 | 7 mm | Blue | 9kN | 366 m (1200 ft) |
| CMC293018 | 8 mm | Green | 12 kN | 366 m (1200 ft) |
| CMC293038 | 8 mm | Red | 12 kN | 366 m (1200 ft) |
| CMC293039 | 9 mm | Orange | 16 kN | 548 m (1800 ft) |

CMC Rescue Lifeline

CMC Rescue Lifeline is an all nylon kernmantle rescue rope manufactured to our specifications by New England Ropes, which meet our demanding performance requirements. CMC Rescue Lifeline has the optimum balance of strength, handling, and durability with minimum sheath slippage. We feel that CMC Rescue Lifeline is your best choice for a life support rope.



Light Use CMC Rescue Lifeline

| | Diameter | Colour | MBS | kg per 100 ft |
|-----------|----------|--------|-------|---------------|
| CMC272430 | 9.5 mm | Red | 21 kN | 2.2 kg |
| CMC272450 | 9.5 mm | Black | 21 kN | 2.2 kg |
| CMC272810 | 11 mm | Orange | 29 kN | 2.5 kg |
| CMC272820 | 11 mm | Blue | 29 kN | 2.5 kg |
| CMC272830 | 11 mm | Red | 29 kN | 2.5 kg |
| CMC272850 | 11 mm | Black | 29 kN | 2.5 kg |

General Use CMC Rescue Lifeline

| | Diameter | Colour | MBS | kg per 100 ft |
|-----------|----------|--------|-------|---------------|
| CMC263200 | 12.5 mm | White | 41 kN | 3.2 kg |
| CMC273210 | 12.5 mm | Orange | 41 kN | 3.2 kg |
| CMC273220 | 12.5 mm | Blue | 41 kN | 3.2 kg |
| CMC273230 | 12.5 mm | Red | 41 kN | 3.2 kg |
| CMC273250 | 12.5 mm | Black | 41 kN | 3.2 kg |
| CMC273270 | 12.5 mm | Yellow | 41 kN | 3.2 kg |
| CMC274010 | 16 mm | Orange | 47 kN | 4.9 kg |

ISC Edge Roller Code VISC ER100A

The ISC Edge Roller protects ropes from damage when working over sharp or abrasive edges. The system is fully modular, consisting of edge roller boxes made from pressed and powder coated aluminium and steel oval maillons which can be easily and quickly linked together to form a chain of whatever length is appropriate for the task. Each box assembly weighs 460 g and consists of one box and two maillons. Each box has a series of rollers which protect ropes in three directions but allow the rope to run smoothly with minimal friction.



Rescuetech Multi-Unit Edge Roller

Code RT-611111 (1 Unit), RT-611112 (2 Units), RT-611113 (3 Units), RT-611114 (4 Units).

A low profile edge protection device featuring an alloy aluminium frame and rollers. Can be used as a single unit or paired up with multiple units to provide large area protection. Units link together with the included rapid links or may be tied using flat webbing to provide long range protection.

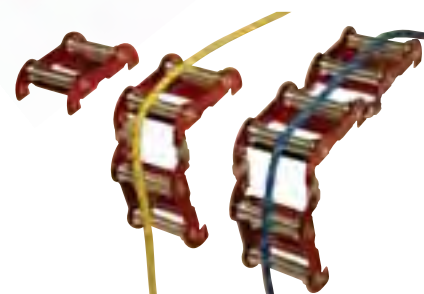

Rope Protectors

Ferno provide various styles of rope protectors that prevent rope damage on sharp, abrasive or dirty edges and help prolong the life of your rope and slings. Available in heavy-duty, flat or in a lighter duty wraparound. For additional security a Kevlar lined version or internal leather version are available for aggressive edges or when repeated sideways movement is anticipated.

- (1) VAS ROP PROT - Light duty
- (2) VAI ROP PROT IND FLAT - Flat
- (3) VAI ROP PROT IND WRAP - Wraparound
- (4) VAI ROP PROT LEA - Leather Wraparound
- (5) VAI ROP PROT KEVLAR - Kevlar Flat

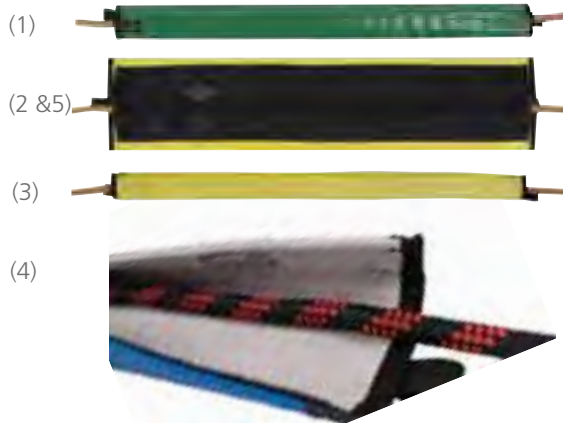

Ultra-Pro Edge Protector

Code CMC294042 (2 Edge Protector) and CMC294044 (4 Edge Protector)

Conforms to the edge but prevents sharp bends in the rope, reducing friction and wear. Ideal during hauling operations. Holes in all corners allow tie off or linked together.



Ferno Industrial Rope Protection Mat

Code VAI ROP PROT MAT

Numerous, flexible full length hinges allows conformity to most edge contours. Corner eyelets provide good tie off and low friction vinyl assists with rope glide while the underside is made with heavy duty nylon. 70 x 60 cm.



Bokat Rope Washer

Code CMC294060

Cleans rope with a combination of water pressure and brushing action. Clamps over the rope and velcro closures allow adjustment to rope size for maximum efficiency. Lined with Astroturf which scrubs the rope as it is pulled through the washer. For use with ropes up to 19 mm in diameter. For optimum rope cleaning, pre-soak rope in Ferno Rope and Harness Wash.



Ferno Rope and Harness Wash

Code VAS WASH (500 ml bottle) and VAS WASH 20 (20 L container)

A highly concentrated, blue liquid that is recommended for use with industrial harnesses, access, rigging and lowering ropes. Ferno Rope and Harness Wash is environmentally friendly, biodegradable and does not contain any phosphates, bleaches or fragrances. It is low foaming, free rinsing with excellent soil removal properties. Available in a 500 mL bottle or 20 L bulk container.



Engel Hot Knife

Code VDPS G4480000 (knife), VDPS G4480001 (blade)

A hot knife/rope cutter for rope and web. This electric handheld unit cuts and fuses the ends of polyester and nylon ropes and webbing. Blade sold separately.



Rope Measurer

Code DONA-PRP9058M

This rope measurer quickly and accurately measures cordage from 4 mm to 19 mm diameter. Counter reads up to 3050 m. Supplied with mounting bracket.



Ferno Rope Bags

Code VBS HIVIS (Heavy-Duty), VBS ROP BAG (Standard)

The Ferno Heavy-duty Rope Bag keeps your rope conveniently stowed, ready for transportation and quick deployment. It comes with a carry handle, backpack straps, pull tight throat closure and is made from 1000 denier vinyl.

Available in 50 m, 100 m, 150 m and 200 m sizes.

The Standard Rope Bag is available in 50 m, 100 m, 150 m and 200 m sizes and is made from 1000 denier cordura. This version comes complete with a single shoulder strap only.

| Bag | Dimensions | Bag | Dimensions |
|-------|---------------------|-------|---------------------|
| 50 m | H 560 mm x D 240 mm | 150 m | H 680 mm x D 300 mm |
| 100 m | H 700 mm x D 240 mm | 200 m | H 850 mm x D 300 mm |



Ferno Heavy-duty Rope Bag

Ferno Standard Rope Bag

Multi Pouch Code VRES MULTI POUCH

The Multi Pouch is an ideal bag for the convenient storage of all rope and rescue gear. The clear faced pouches provide an uninterrupted view of all equipment, assisting in quick identification and deployment. The Multi Pouch is made from tough 1000 denier nylon. Each Multi Pouch features integral carry handle and backpack straps. The Multi Pouch has been a favourite with emergency services personnel for many years.



All Purpose Grab Bag Code VBI CARRY

This multi-purpose bag is ideal and large enough for storing your harness and all related gear to make up your own kit. A handy daisy chain is located inside the zipper opening for convenient storage of karabiners and other gear. Available in a variety of colours: maroon, black, red, yellow and blue. Dimensions: L 580 mm x D 300 mm



Expedition II Duffel Bag Code VBS EXP 2 HD

The Expedition II Duffel Bag is a sizeable bag with a 75 L capacity that is made tough to carry rescue, industrial or climbing gear. This bag is made from 1680 denier nylon with integral shoulder and carry straps and is a favourite from our outdoor range. Dimensions: L 750 mm x W 300 mm x H 200 mm



Ferno Haul Bag

Code VBI HAUL IND L (Black Leather), VBS HAUL 200 C (Black Cordura), VBI HAUL IND (Yellow Vinyl)

The Ferno Haul Bag is a tough, hard wearing bag that has a safe working load of 250 kg and an impressive 90 L gear capacity. It includes oversized easy to attach haul loops and heavy duty back pack straps. The bag also features two separate pull tight draw strings to secure its load as well a four D-rings around the base for stabilising the load during long distance hauling. Available in either leather or 1680 cordura.



Ferno Shotbag

Code VKIT THROW BAG

The Ferno Shotbag consists of a dipped throw bag attached to 30 m of cord all housed in a convenient storage bag.



Gear Bag

Code VARB GB

A universal, heavy-duty Cordura bag with robust handle and draw-string top. Self supporting but still capable of collapsing for storage.

Dimensions: L 150 mm, W 150 mm, D 150 mm



Riggers Leather Gloves

Code SM-RG

Manufactured from hard wearing leather with stitched in gusseted panels for strength and comfort. These riggers/roping gloves will be a welcome addition to your personal protection kit. Available in sizes M, L, XL and XXL.



Ringers Authentic Glove

Code RING-133

A multi-purpose glove with a hook and loop wrist strap. Features a snug fit design, unique split palm, Clarino® finger and palm patches, tough spandex top material and hidden seams which provide comfort and feel.

Available in S, M, L and XL.



Ringers Rope Rescue Glove

Code RING-353

The Ringers Rope Rescue Glove is ideal for optimum grip and control in inclement weather. This glove ensures a snug fit that assists with effective dexterity. This is achieved through the use of velcro secure elastic closures and Kevlar stitching. The Ringers Rope Rescue Glove utilises uniquely designed gel pads in conjunction with the finger and palm patches, ensuring optimum rope control and hand protection. Available in S, M, L and XL.



Ringers Extrication Glove - Long Cuff

Code RING-304

The Ringers Extrication Glove with a long cuff is built for durability. These gloves are made from durable Clarino material, which is tougher than leather. The reinforced index finger and thumb joints, along with the puncture resistant palm pads, make the knuckles, palms and finger tips resistant to abrasions. The elastic cuff keeps out glass and debris, reducing the chance of injury. Despite the toughness of these gloves, they still provide enough feel to palpate a pulse. Available in S, M, L and XL.



CT Glove Half and Full Finger

Code VCT 7X980 (AA, AB, AC, AD) M L XL XXL Half Finger, VCT 7X980 (OA, OB, OC, OD) M L XL XXL Full Finger

A comfortable leather glove that offers enhanced hand protection from rope friction. The moisture wicking properties are enhanced by the perforated top leather surface. Exposed fingers provide normal finger dexterity and feel. The full finger provides additional protection.

Full Finger 108 g. Half Finger 100 g.



Ferno Rescue Personal Lanyard (PAL)

Code Vas DAISYADJ

The Ferno Rescue Personal Lanyard allows a rescuer to quickly connect to a victim and then adjust the strap to the desired length. It works well for positioning the victim for a lowering or rappel-based pick off or for an assisted rappel. There is an added loop to the end for a more positive grip when pulling to adjust. Depending on how the buckle is loaded, it will begin to slip between 15 kN to 20 kN. Tying off the buckle will increase strength.



Ferno Industrial Daisy Chain

Code Vai DAISY H/D BLK

The Ferno Industrial Daisy Chain is ideal for positioning the casualty during work operations and is a must for all Rope Access and Rescue Technicians. A total length of 1.1 m with an end to end rating between 15 kN to 20 kN (load angle dependent). Each unit comes with 10 x 60 mm attachment loops and is made from durable 25 mm flat polyester web. Each loop rated to 5 kN.



Ferno Slings

Codes VSL R32kN (25 mm round), VSL S80kN (50 mm heavy-duty flat snake) and VSL S30kN (50 mm flat snake)

Every Ferno Sling is made from high grade, abrasion resistant webbing and is available in a variety of colours and lengths. The different styles provide the user with the option to wrap the sling in a single, double or triple style or tie end to end making them a versatile and handy adjunct for forming temporary anchor points. Manufactured in accordance to AS/NZS 1891.



25 mm Round Sling



50 mm Heavy-duty Flat Snake Sling



50 mm Flat Snake Sling

Hi-Safe Tie-Off Sling With D-rings

Code HS-AC10 (1 m), HS-AC20 (2 m)

Made from high grade, abrasion resistant webbing. Available in safety orange with two convenient D-rings permanently attached. A universal sling tie-off and for forming temporary anchor points.



Girth Hitch Sling

Code Vsl G30kN

The Girth Hitch Sling differs significantly in design and performance from other adjustable anchor straps, allowing it to handle a higher load before slipping. The D-ring on one side is larger than the other, so the other end can pass through, allowing the straps to be rigged in a girth hitch. Available in lengths from 30 cm to 2.5 m



Etrier and Aider Four and Five Step

Code Vas ETRIER 4 & 5 and Vas AIDER 4 & 5

The Etrier and Aider Four and Five Step are ideal for rescue, rope access and recreational aid climbing. The 25 mm tubular webbing and dense vinyl stiffening ribs remain rigid, ensuring ease of foot placement and superior abrasion resistance.

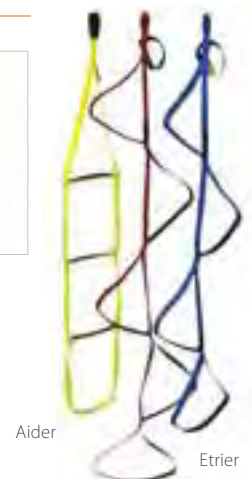
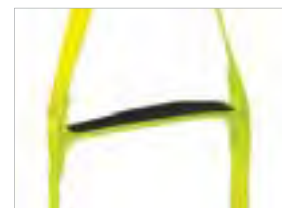

Aider

Etrier

TNT Rescue Tools

TNT Rescue Tools are designed by rescue and emergency personnel with user and victim in mind. Each TNT Rescue Tool is supplied with a lifetime warranty. TNT Rescue Tools exceed industry safety factor standards and are certified in accordance with NFPA 1936.



TNT Rescue Cutters & Spreaders

True Variable Speed Control (TVSC) with deadman feature provides unparalleled control. Well balanced for accurate positioning and uncomplicated operation in all positions for left or right handed operators.



| Models | TNT-BFC-320 | TNT-SLC-24 | TNT-SLC-27 | TNT-SLC-28 | TNT-SLC-29 | TNT-CSC-40 |
|--------------------|-------------|------------|------------|------------|------------|------------|
| Max. blade opening | 197 mm | 127 mm | 178 mm | 193 mm | 193 mm | 38 mm |
| Max. cutting force | 1424 kN | 528 kN | 528 kN | 694 kN | 1197 kN | 155 kN |
| Deployment weight | 22.5 kg | 15.3 kg | 15.3 kg | 17.9 kg | 18.4 kg | 4.9 kg |



| Models | TNT-S-100-24 | TNT-S-100-28 | TNT-S-100-32 | TNT-CSS-40 |
|-------------------|--------------|--------------|--------------|------------|
| Max. opening | 610 mm | 711 mm | 813 mm | 203 mm |
| Max. spread force | 286 kN | 249 kN | 225 kN | 22.3 kN |
| Deployment weight | 18.7 kg | 19.8 kg | 20.6 kg | 4.5 kg |

TNT Rescue Combination Tools

TNT Rescue Combination Tools are a cutting and spreading tool in one. Made from high quality heat treated steel. The unique blade profile and unique cutting blades make them the choice for quick, one tool rescue operations.

Product Specifications

| Models | TNT-SLCC-20 | TNT-SLCC-30 |
|-------------------|-------------|-------------|
| Max. opening | 393 mm | 355 mm |
| Max. cut force | 528 kN | 528 kN |
| Max. spread force | 93.3 kN | 70.5 kN |
| Deployment weight | 16.5 kg | 17.6 kg |



TNT Rescue Forcible Entry Kit

Codes TNT-FE-5.0 (without handle), TNT-FE-9.0 (without handle), TNT-FE-5.0-H (with handle), TNT-FE-9.0-H (with handle)

Designed to reduce pinch points, light, portable and ideal for situations where immediate action and quick access is critical.



TNT-FE-9.0-H

TNT Rescue Rams

Industry leading push and pull capabilities making them ideal for heavy equipment and machinery. The Ram tip and base plates have aggressive bear teeth edges for better grip strength and greater control. TNT Rescue Rams can also be used with chain systems for pulling operations.



Product Specifications

| Models | TNT-R-20 | TNT-R-30 | TNT-R-40 | TNT-R-50 | TNT-R-60 | TNT-TLS- 25 | TNT-TLS-50 |
|--------------------|----------|----------|----------|----------|----------|-------------|------------|
| Closed length | 462 mm | 542 mm | 673 mm | 803 mm | 927 mm | 425 mm | 546 mm |
| Extended length | 630 mm | 775 mm | 1,029 mm | 1,286 mm | 1,538 mm | 832 mm | 1278 mm |
| Highest push force | 147 kN | 147 kN | 147 kN | 147 kN | 147 kN | 229 kN | 229 kN |
| Highest pull force | 79.6 kN | 79.6 kN | 79.6 kN | 79.6 kN | 79.6 kN | NA | NA |
| Deployment weight | 12.2 kg | 14.5 kg | 16.8 kg | 18.6 kg | 21.3 kg | 18.2 kg | 21.5 kg |

Ram Extension Kits

Codes TNT-TLS (TLS Kit), TNT-XR (XR-Kit) and TNT-R (R-Kit)

XR-Kit

- Small standard saddle
- C-saddle
- Conical
- Wedge
- Cutting head
- Peeling/cutting head
- 9 cm push plate
- 14 cm push plate



TLS Kit

- 12.5 cm and 25 cm extensions
- Small standard saddle
- C-saddle
- Conical
- Wedge
- Cutting head
- 14 cm push plate
- Peeling/cutting heads



R-Kit

- 12.5 cm and 25 cm extensions
- Small saddle
- Conical
- 14 cm push plate



Air Hydraulic Pump

Codes TNT-ARP

- Single-tool operation
- Lightweight aluminium
- SCBA cylinders compatible
- Weight 9.9 kg
- Internal dual stage pressure relief valve



Hydraulic Hand Pump

Codes TNT-HDP

- Two-stage operation
- Single-tool operation
- Weight 13.1 kg



TNT Rescue Tool Mounts

TNT Tool Mounts are designed to hold your TNT Rescue Hydraulic Tools securely in place while in a vehicle or in storage. Available in both plastic and steel.



NEXUS Shunt Valve Coupler Technology

TNT Rescue tools come with an option of couplers including our standard coupler, optional flat coupler or the Nexus Shunt Valve Coupler. The Nexus Coupler is the ultimate single connection coupler system designed with the ability to hot swap tools on over 100 feet of line (under pressure) with no requirement for a special tool to release the pressure.



TNT Rescue Pumps

TNT Rescue Systems have been building pumps for industrial, defence and rescue applications for more than four decades. This experience and knowledge is engineered into every TNT Pump. TNT pump pistons are supercharged through TNT's exclusive Oil Supercharging System (OSS) preventing piston short stroking and slap. TNT two-stage pumps use an exclusive piston-over-piston design allowing pumps to achieve higher first-stage pressure settings, giving the user greater tool speed and performance.

Quad Power Unit *Code TNT-DT-10.0*



- Four Tool Simultaneous
- Ten HP Yanmar Diesel Engine
- Single stage radial piston over piston pump
- High flow, four tool simultaneous operation
- 12 volt electric or recoil start
- Weight 105 kg

Accelerator Pump *Code TNT-ATT-6.5*



- Two tool simultaneous operation
- Single tool operation at twice the speed
- Supercharged hydrostatic two stage radial piston pumps
- True Simo unit with 2 separate pumps sharing one reservoir
- Flip down handle for compact storage
- Optional roll cage
- Honda petrol, Yanmar diesel or Leeson electric motor

Twin Simo Pump *Code TNT-BT-6.5 (Honda 6.5 HP Petrol), TNT-DT-4.0 (Yanmar 4 HP Diesel) TNT-ET-4.0 (Leeson 4 HP Electric)*



- Two tool simultaneous operation
- Supercharged hydrostatic two stage radial piston pumps
- True Simo unit with two separate pumps sharing one reservoir
- Flip down handle for compact storage on BT-6.5
- Optional roll cage on BT-6.5 (D T & ET 4.0 roll cage standard)
- Available with Honda 6.5 HP petrol, Yanmar 4.0 HP diesel or Leeson 4.0 HP electric motor

Bantam Pump *Code TNT-BT-3.0 (Honda 3.0 HP Petrol), and TNT-ET-2.0 (Leeson 2.0 HP Electric)*



- Two tool connection allows alternate operation of tools
- Supercharged hydrostatic 2 stage radial piston pumps
- Lightweight with easy manoeuvrability
- Small and compact for convenient storage
- Optional roll cage (ET 2.0 roll cage standard)
- Honda 3.0 HP petrol or Leeson 2.0 HP electric motor

Nitro Pump (One Tool Operation) *Codes TNT-BT-1.5 (Honda 2.5 HP Petrol)*

- Single Two tool operation
- 2 stage radial piston over piston pump
- Lightweight 13 kg with easy manoeuvrability
- Small and compact for convenient storage
- Honda 2.5 HP petrol engine



TNT Rescue High Pressure Lifting Bags

TNT Rescue High Pressure Lifting Bags are durable bags made from SBR rubber, which is resistant to physical and chemical damage. These bags are strengthened by Kevlar cord reinforcement. Interlocking dimples provide superior gripping, therefore significantly reducing the possibility of slippage and making it safer to use a combination of lifting bags in one single lifting operation.



TNT High Pressure Lifting Bags

TNT High Pressure Lifting Bags have a unique surface with interlocking dimples to provide superior gripping.



| Models | SLK 1/3 | SLK 3/5 | SLK 7/6 | SLK 9/7 | SLK 13/9 | SLK 21/11 | SLK 26/12 | SLK 34/14 | SLK 43/17 | SLK 70/20 |
|-------------------|------------|----------------|------------|------------|------------|------------|------------|------------|------------|------------|
| Size | 15 x 15 cm | 22.5 x 22.5 cm | 30 x 30 cm | 38 x 38 cm | 45 x 45 cm | 55 x 55 cm | 61 x 61 cm | 69 x 69 cm | 78 x 78 cm | 91 x 91 cm |
| Lifting Height | 7 cm | 13 cm | 15 cm | 18 cm | 22 cm | 27 cm | 30 cm | 36 cm | 42 cm | 51 cm |
| Capacity Lift | 1,000 kg | 2,800 kg | 5,700 kg | 9,600 kg | 12,700 kg | 20,300 kg | 24,700 kg | 31,500 kg | 41,400 kg | 66,100 kg |
| Individual Weight | 0.60 kg | 1.3 kg | 2.4 kg | 4 kg | 5.3 kg | 8.1 kg | 11.2 kg | 13.3 kg | 18.2 kg | 25.3 kg |

TNT Rescue Medium Pressure Lifting Bags

Heavy duty Kevlar reinforced construction ensures long service life. Low profile design allows insertion under objects with just 50 mm clearance.

| Models | SMP 24/17 | SMP 30/23 | SMP 36/24 | SMP 48/40 |
|--------------------|-----------|-----------|-----------|-----------|
| Diameter | 61 cm | 76 cm | 91 cm | 122cm |
| Max. Lift capacity | 2,976 kg | 4,650 kg | 6,694 kg | 11,902 kg |
| Max. Lift | 43 cm | 59 cm | 61 cm | 100 cm |
| Volume | 295 L | 620 L | 900 L | 3,010 L |
| Weight | 6 kg | 7 kg | 7 kg | 10 kg |



TNT Rescue Lifting Bags Flat Form

Resists retain their flat surface and resist rolling and shifting and will not round out when inflated. Can be stacked 2 or 3 high for greater lifting height. 25 mm in height per bag.

| Models | SFF-7/7 | SFF-12/7 | SFF-20/8 | SFF-35/8 |
|--------------------|------------|------------|------------|-----------|
| Bag dimension | 55 x 55 cm | 61 x 61 cm | 78 x 78 cm | 91 x 91cm |
| Max. Lift capacity | 7,112 kg | 12,193 kg | 20,321 kg | 35,562 kg |
| Max. Lift height | 8 cm | 18 cm | 20 cm | 20 cm |



TNT Rescue High Pressure Power Lift Programs

Codes TNT-ABSS42 (42 Ton Starter Set), TNT-ABMS110 (110 Ton Medium Duty Set) and TNT-ABAS162 (162 Ton Advanced Set)

The TNT Rescue High Pressure Power LIFT Program offers a kit system approach to your lifting bag needs.

42 Ton Starter Set

- 2 x SLK-21/11 Lifting Bags
- 1 x U-0450 Regulator (6000 psi)
- 1 x HD-2 Dual Deadman Controller
- 1 x HH-20' blue hose
- 1 x HH-20' red hose

110 Ton Medium Duty Set

- 2 x SLK-21/11 Lifting Bags
- 2 x SLK-34/14 Lifting Bags
- 1 x U-0450 Regulator (6000 psi)
- 1 x HD-2 Dual Deadman Controller
- 2 x HH-35' green and black hose
- 2 x HI-35' red and blue hose w/inline relief

162 Ton Advanced Set

- 1 x SLK-9/7 Lifting bag
- 2 x SLK-21/11 Lifting bags
- 2 x SLK-34/14 Lifting bags
- 1 x SLK-43/17 Lifting bag
- 2 x U-0450 Regulator (6000 psi)
- 2 x HD-2 Dual Deadman Controller
- 2 x HH-35' Green & black hose
- 2 x HI-35' Red & blue hose w/inline relief

Ferno Vehicle Extrication Glass Maintenance Kit Code VRES GLASS MGNT KI

The Vehicle Extrication Glass Maintenance Kit contains the essential gear required to access and protect motor vehicle victim and rescue personnel. All gear is housed within a sturdy carry bag.

| Qty | Description | Code |
|-----|--|--------------------|
| 1 | Flexible 6 mm PVC Mat Small 65 cm x 40 cm | FWE- VEGMK FPL |
| 1 | Flexible 6 mm PVC Mat Large 85 cm x 45 cm | FWE- VEGMK FPS |
| 1 | Rigid 3 mm Clear Polycarbonate Mat Small 65 cm x 40 cm | FWE- VEGMK RPPS |
| 1 | Rigid 3 mm Clear Polycarbonate Mat Large 77 cm x 44 cm | FWE- VEGMK RPPL |
| 1 | Clear PVC Sheet 0.5 mm 1.9 m x 1.4 m | VJES PVC CLEAR 0.5 |
| 1 | Orange PVC Work Sheet 1.9 m X 60 cm | VRR AKA520 ORA |
| 2 | Spring Loaded Clamp 85 mm | FWE- BWH IR |
| 6 | Clear Plastic Drop Sheet | FWE- VEGMK CPDS |
| 1 | Windscreen Rubber Surround Removal Tool | EB-GC130A |
| 2 | Shaving Foam | FWE- VEGMK SF |
| 1 | Ferno Glass Saw with Integral Window Punch | FWE- VEGMK GS |
| 1 | Glass Catching Net | VRES GC |
| 1 | Emergency Hammer with Seatbelt Cuter and Flashlight | FWE- VEGMK DEH |
| 1 | Carry Bag Red | FWE- VEGMK CB |
| 1 | Contents List | FWE-VEGMK CL |



TFT Res-Q-Rench Code CMC635025

This versatile multi-purpose tool is designed for ground fire operations and rescue incidents. Works with rocker lug handline and supply line couplings and many domestic gas shut off valves. Includes an integral carbide tip window punch and heavy duty seat belt cutter. Ued as a pry bar for windows or a door/window prop. Weight 142 g. Length 210 mm (closed) 315 mm (open)



CMC Rescue Seat Belt Cutter Code CMC294020

The CMC Rescue Seat Belt Cutter is an inexpensive, razor sharp seat belt cutter that should be kept in every vehicle and first aid kit. It can be easily and safely used by anyone to quickly cut seat belts, web or light cord. Weight 28 g



Guides Safety Knife Code CMC294013

The safe way to cut rope up to 15 mm and webbing up to 6 mm without an exposed blade. Spare blades are stored n the handle. This knife comes in vibrant yellow.



Res-Q-Me Rescue Tool Code CMC634007

The Res-Q-Me easily cuts through seat belts and the integral window punch breaks side and rear vehicle windows. The Res-Q-Me is safe and easy to carry in your pocket, bag or purse or small enough to fit on a key chain. Weight 17g,



McNett Knives

High quality essential knives for all outdoor activities including rafting, kayaking, search and rescue, scuba diving, camping, hunting, fishing and more. Made under exacting conditions with corrosion resistant 420 stainless steel. McNett Knives completely disassemble for easy cleaning and the handles are form fitting and slip resistant. Numerous attachment points allow fitting to gear belts, harnesses, P.F.D. or B.C.Ds.



Mag Charger Rechargeable Flashlight System

Code DET-MBC (system) DET-MR (battery only)

Without question the Mag Charger Rechargeable Flashlight System is the ultimate lighting tool. Refined and enhanced over many years of dedicated service, Key features include solid-state electronics, limited lifetime warranty, individually serial numbered, up to 1000 hours of battery life, durable extra hard anodised finish, charger operates on A/C or D /C current, easily replaced high intensity halogen lamp, one quarter turn cam action focus spot to flood, self cleaning rotary switch, three positions - on, off and signal.

320 mm x 40 mm (barrel diameter)

60 mm head diameter, 907 g with batteries



Mini Maglite Flashlight 2-Cell AA

Code DET-MAA

The Mini Maglite Flashlight 2-Cell AA is a classic American design. Famous around the world for its brightness, quality, durability and dependability.

Key features include, high intensity light beam, half turn twist-focus spot to flood, spare lamp secured in tail cap, high strength alloy case, limited lifetime warranty. 146 mm x 18 mm barrel diameter

25 mm head diameter, 107 g with batteries



Mini Maglite Flashlight 2-Cell AAA

Code DET-MAAAB

The Mini Maglite Flashlight 2-Cell AAA has all the same features and functions as the AA Mini Maglite in a smaller lighter version for ease of use and storage. Key features include, high intensity light beam, half turn twist focus spot to flood, spare lamp secured in tail cap, high strength alloy case, limited lifetime warranty. 127 mm x 13 mm barrel diameter

19 mm head diameter, 49 g with batteries



Princeton Tec Fuel

Code OUTD-PRI00000

Designed to meet the widest range of applications while remaining small, lightweight and robust. Suitable for camp set-up, trekking, climbing and emergency signalling. An adjustable pivoting head with 3 ultrabright LEDs provide 35 lumens of even light with minimum shadow. Three levels of light output and two blinking emergency signalling modes. 3 x AAA batteries included. Weight 78 g.



Princeton Tec EOS 2 Industrial Headlamp

Code OUTD-PRI00002

The Class I, Division 1 (groups A, B, C, D*) rating makes the EOS II the safest choice when working in hazardous environments. The single LED puts out an incredible 50 lumens and has a running burn time of up to 60 hours. The rubber head band sticks helmets. Waterproof to one meter. Comes with standard elastic and velcro mounting patch. 3 x AAA batteries included. Weight 105 g



Princeton Tec APEX Headlamp

Code DET-PTAP

Ideal for long and short distances with 130 lumens of light, five modes, heat regulation and a battery power meter. The APEX combines a regulated three watt Maxbright LED with four regulated Ultrabright LEDs for constant brightness on all modes. A dual switch system allows the user to switch modes and independently control the intense, close or long range lighting. Available in orange or black. Accepts 4 AA alkaline, lithium, NiMH recharge batteries. Weight 279 g with batteries.



Snap Lite Lightstick Safety Light

Code CMC108016 (green) and CMC108017 (yellow)

The Snap Lite Lightstick Safety Light are spark proof, non-flammable, non-toxic, non-corrosive, weather proof and have played an essential role in lighting emergency scenes. These light sources are ideal for marking the location of access points, personnel and equipment. Snap Lite Lightstick Safety Lights are available in yellow and green and burn for up to 12 hours



Ferno Triage Tags

Code MIR-FTT

Designed for use at mass casualty incidents (MCI) the Ferno Triage Tags are water proof and have been designed with the most recent MCI management concepts. It is compatible with the START (Simple Triage And Rapid Treatment) triage system. The tags are individually numbered and have a tear off section for tracking personal belongings and for the transport personnel. Ferno Triage Tags come in a packet of 50. Height 215 mm, Width 115 mm



First Response Triage Kit

Code MIR-AME-435

The First Response Triage Kit is a versatile kit that allows first arriving emergency personnel to quickly initiate triage operation at a mass casualty incident. The First Response Triage Kit is packed in a durable, easy to clean nylon carry case which is small enough to be placed in a staff, ambulance or fire rescue vehicle.

Kit Includes

- Durable yellow triage vest with adjustable sides
- Triage officer checklist
- Red, yellow, green and black rolls of triage ribbon
- Metal clipboard and START (Simple Triage And Rapid Treatment) algorithm card
- Triage supply pouch for storage of tags, ribbon, markers, airways, trauma dressings, EMT scissors, pens and grease pencils
- EMT scissors, pens and grease pencils
- 25 Ferno Triage Tags



Vertical Neat Seat

Code VAS NEAT S (small) VAS NEAT L (large)

The Neat Seat is a padded, lightweight seat that is a fantastic adjunct to your rescue gear. Made from durable nylon with adjustable stays. Folds flat and inconspicuous for inclusion on any trip.



Body Bags

Codes DPBB and DPBB-H

These Body Bags are a large size with a zipper on three sides for ease of body handling. The Body Bags are made from heavy duty PVC, and are available with or without eight integral handles for handling during transportation. Length 2080 mm. Width 900 mm.



Go Anywhere Toilet Kit Code MIR-D019W

The most hygienic, safe, environmentally-friendly, portable toilet solution available. Commonly used in disaster response by emergency services and defence forces the Go Any Toilet Kits are also used for remote outdoor programs or in remote and sensitive habitats. The kit prevents spread of disease with no spills, splash backs or waste contact. The toilet kit is a completely biodegradable solution that traps, encapsulates, deodorises and breaks down waste with a NASA developed gelling agent. Can be used with the Go Anywhere Toilet System, non working toilets or by itself. Each kit includes a zip close disposal/transport bag, a waste collection bag preloaded with poo powder gelling agent , toilet paper and a hand sanitiser.



box of 12



individual kit

Pee-Wee Personal Unisex Urine Bag

GC-D449PW3 Pkt 3 GC-D455PW12 Pkt 12

Pee Wee Unisex Urine Bags can provide freedom from planning lives, trips, outdoor recreational outings around the proximity to the toilet. Each bag contains NASA developed proprietary gelling agent that traps, encapsulates, breaks down and deodorises waste instantly. Packs out without leaks or spills, in portable solidified and fully biodegradable form.



Poo Powder Waste Treatment Code MIR-D105POW

The Poo Powder Waste Treatment container has 120 scoops of Poo Powder. Each scoop contains enough powder to treat up to 600 g of liquid and solid waste. Poo Powder can be used by itself or used to extend the Go Anywhere Toilet Kit, simply sprinkle a scoop over the waste. Weight 1.9 kg.



Go Anywhere Toilet Code MIR-D119PET

The Go Anywhere Toilet structure is available separately and sets up in seconds with no assembling required. Designed to keep the outside of the waste bag clean, assisting with the hygienic transportation and removal of filled bags. The Go Anywhere Toilet is lightweight and conveniently folds into a briefcase. Comes supplied with 3 x Go Anywhere Toilet Kits. Weight: 3 kg
Dimensions: L 480 mm, H 35 mm, D 130 mm



The Go Anywhere Toilet System Code MIR-PETT

The easy to use Go Anywhere Toilet System provides privacy and a sanitary and odourless method of packing out and disposing of liquid and solid waste. It is ideal for remote locations or for disasters and emergencies. All items fit into a backpack, which contains additional Go Anywhere Toilet Kits to transport used waste bags. The pack weighs 8 kg with contents included Contents include 1 x Go Anywhere Toilet, 1 x Clean Waste Privacy Shelter, 1 x Clean Waste Backpack, 15 x Go Anywhere Toilet Kits.





Xcaper Smoke Filters and Masks

The Xcaper Smoke Filter is the world first moist direct-contact smoke and particulate filtration mask. It uses patented technology combining a natural-based aloe gel extract and negatively charged styrene beads to attract and neutralise 100% of gases like Hydrogen Cyanide, Acrolein and Carbon Monoxide. It reduces 100% of dust and particulate matter down to 3/10th of one micron. The Xcaper technology is lab-verified, approved for use by the US Navy and has been proven in tens of thousands of live fire situations over the last 8 years by more than 75,000 professional firefighters. The unique features of this smoke mask provide it with unsurpassed ease-of-use, comfort, respiration, portability and unparalleled protection.

Xcaper Moist Filter *Codes XCF-XF*

The revolutionary Xcaper Moist Filter traps particulate matter and absorbing hazardous gases (Hydrogen Cyanide, Carbon Monoxide and Acrolein) common to smoke in bush fires, structural fires, overhaul, arson investigation and various SWAT situations. The filter contents include a combination of natural hypoallergenic plant extract and styrene beads which makes the filter moist and cool to the touch. The styrene beads trap particulate matter. The filter fits any shape or size face. The filter will last five to eight hours in a bush fire situation. Weight 62 g.



Whiffs Brush-Pro Mask

Code XG-BPM-WHIFM (Standard) XG-TAPM-WTAPM (Black)

Whiffs Brush Pro Mask is easier to put on and take off simply tie the elastic band behind your neck. Made of Advance Nomex which carries a 565°C heat rating. Recommended for bushfire fighting and structural overhaul/mop-up. Attachment points at the bridge of the nose allow attachment of goggles and exterior velcro attachment points allow fitting of the optional neck shroud. Also available in colour black. Weight 57 g.



Whiffs Nomex Shroud *Code XG-BPS-WMSRD*

The Whiffs Nomex Shroud fits the Brush-Pro Masks and is the essential accessory when more protection is needed. Made of Advance Nomex which carries a 565°C heat rating. The Whiffs Nomex Shroud is machine washable in cold water and should be hung out to dry. Weight 73 g.



Whiffs Manta *Code XG-WMX20, XG-WMX30*

The New Manta X20 and X30 are made of Carbon X material and Kevlar elastic with Nomex thread. A Bandana shape and stretchable material makes it easy to pull down and up when needed. Used with an Xcaper Filter (which filters hazardous gases and vapors and 100% of particulate matter) you have the perfect combination of protection for 4 to 6 hours. The filter simply Velcro®s to the inside of the bandana. Each Manta comes with one Xcaper Moist Filter. (The Manta X30 is a slightly larger version of the Manta X 20).



Alta Superflex Knee Pads *Code CMC355413*

Alta Superflex Knee Pads have a 12 mm layer of foam padding to reduce stress and fatigue, allowing you to work longer and more effectively during heavy rescue operations, confined space entries or tactical responses. Alta pads are a lightweight 340 g. The rubber caps grip the surface to prevent sliding and the buckle fastening system provides a comfortable fit. Available in black.



Alta Flex Industrial Elbow Pads *Code CMC355310*

Alta Flex Industrial Elbow Pads protect you during horizontal confined space entries, cave rescue or tactical responses. The non-slip, rubber caps grip the surface, allowing for faster movement. The rubber caps grip the surface to prevent sliding and the buckle fastening system provides a comfortable fit. Weight 170 g. Available in black.



X-Work Safety Helmet *Code VCT6X94407 (white) VCT6X94401 (orange)*

The X-Work Safety Helmet is comfortable and light weight with a high impact absorbing capacity making it ideal for all day use. The removable chin strap allows the helmet to be used on ground or working at height. Key features include, aeration holes for ventilation, one hand adjustment of the headband, reduced peak visor for a superior visibility, comfortable interior fabric sweat-proof sponge, head lamp clips and hearing protection slots. Size range 54 cm to 62 cm. Weight 370 g. EN 397 Industrial Helmet Standard Approved.



The Vertical Sunbrero *Code VAS SUNBRERO*

Fits over your helmet and extends beyond the rim to block 100% of UV ray and to stop glare and sun from your face, ears and the back of your neck. Made of durable, cordura nylon, the Sunbrero has an elastic band that grips to the helmets and secures to the headlamp retainer clips.



Ferno Raider Level 100 PFD

The Ferno Raider Level 100 PFD is a heavy duty commercial jacket with subtle modifications that provides excellent protection and comfort for emergency services and first responders. A large, adjustable front pocket provides room for a GPS or radio. Reflective tape on the shoulders provide night time visibility and a mandatory whistle is firmly attached. Hinged panels and full side adjustment for optimum fit and comfort. 600D polyester with double stitched and bound seams, box tacked webbing belt loops and bar tacked stress points. Complies Australian Standards AS4758. Available in adult sizes S/M/L/XL. Custom modifications and labelling available, conditions apply.



Fox 40 Whistle *Codes CMC180011*

The Fox 40 Whistle is a reliable whistle that works under almost any conditions and has a reputation for being one of the loudest whistles available. This whistle is made of a durable plastic and does not have a pea that will stick or swell when wet, nor will it rust or transfer cold like a metal whistle. Colour Orange



CMC Confined Space Entry & Rescue Training Manual

Code CMC993214

Newly revised, the CMC Confined Space Entry & Rescue Training Manual has been updated with three new chapters: Communications, High Point Anchor Systems, and Permitting Confined Spaces. This manual contains the most practical, up-to-date information on laws and regulations for confined space entry in the USA, development of a rescue team, assessment and preparation for entry, organisation of an emergency response, monitoring for and managing atmospheric and other hazards, rescue equipment and patient transport.



Confined Space Entry and Rescue Field Guide

Code CMC993224

The Confined Space Entry and Rescue Field Guide puts a wealth of information in a pocket size book that you can take with you. Sections include classification and effects of hazards, charts for ventilation, communication systems, rope work, response management and general information that will help keep rescuers safe. Printed on water and tear-proof paper.



CMC Rope Rescue Manual 4th Edition

Code CMC993221

CMC Rope Rescue Manual has become the standard reference for many departments and rope rescue training programs and reflects the knowledge from many years of responding to rescues and teaching thousands of students. The manual includes extensive illustrations and step-by-step procedures. Topics include: safety, equipment, rappelling, pick-offs, stretcher evacuations, patient packaging, improvised high anchor points, lowering and raising systems, mechanical advantage and organising the response.



Rope Rescue Manual Field Guide

Code CMC993232

The companion Field Guide to the 4th Edition of the CMC Rope Rescue Manual features water and tear proof paper. 10 cm wide, the guide fits uniform pockets, so you can take it with you.



XCEED Latex Glove Box 250 Code MFXC

The XCEED® glove is a lighter weight glove made with a breakthrough formulation – Avantex™. Lighter, thinner nitrile with a supple softness to reduce hand fatigue with 60% increased strength and durability for better barrier protection. XCEED® are packed 250 gloves per box providing a superior per glove price.

| Sizes | Gloves per box | Length | Colour | Glove Exterior |
|-----------------|----------------|--------|--------|----------------------|
| XS, S, M, L, XL | 250 (230 XL) | 245 mm | Blue | Textured finger tips |



UltraSense (Standard Examination) Nitrile Glove Code MFUS

Next generation nitrile formulation provides the comfort fit and feel of latex while maintaining the reliable barrier protection of a synthetic glove. Recommended for use when handling small instruments, for light tasks that require excellent grip on a day-to-day basis and repetitive duties that may cause hand fatigue. Non-stick properties are resistant to tapes and adhesives.

| Sizes | Gloves per box | Length | Colour | Glove Exterior |
|-----------------|----------------|--------|--------|------------------|
| XS, S, M, L, XL | 100 | 245 mm | Blue | Textured fingers |



UltraSense (Standard Examination) Nitrile Glove Code MFUS

Next generation nitrile formulation provides the comfort fit and feel of latex while maintaining the reliable barrier protection of a synthetic glove. Recommended for use when handling small instruments, for light tasks that require excellent grip on a day-to-day basis and repetitive duties that may cause hand fatigue. Non-stick properties are resistant to tapes and adhesives. Packed 100 gloves per box, maximising your savings.

| Sizes | Gloves per box | Length | Colour | Glove Exterior |
|-----------------|----------------|--------|--------|------------------|
| XS, S, M, L, XL | 100 | 290 mm | Blue | Textured fingers |



Supreno Nitrile Glove Code MFSS

Supreno® SE gloves are the best combination of strength and durability in an all-purpose yet comfortable synthetic glove. Recommended for use when strength and protection are of great importance and when day to day hazards require the best combination of durability and security.

| Sizes | Gloves per box | Length | Colour | Glove Exterior |
|-----------------|----------------|--------|--------|------------------|
| XS, S, M, L, XL | 100 | 245 mm | Blue | Textured fingers |



Supreno Plus Nitrile Glove Code MFSP

Supreno® EC gloves are a durable nitrile glove for high-risk applications. Supreno® EC gloves offer all the benefits of a nitrile glove, with the most important being unique and reliable protection against the hazards you work with. Supreno® EC gloves are formulated for enhanced strength and durability while maintaining a comfortable fit. The extended coverage over the wrist and forearm is needed for enhanced safety and security when working in environments that demand consistent grip and reliability.

| Sizes | Gloves per box | Length | Colour | Glove Exterior |
|-----------------|----------------|--------|--------|------------------|
| XS, S, M, L, XL | 50 | 290 mm | Blue | Textured fingers |



Midnight Black Nitrile Glove *Code MFMK*

The MidKnight glove is a black, powder free nitrile glove that offers the superior combination of durability and protection against day-to-day hazards. MidKnight provides an exceptional balance of performance, comfort and durability. Designed specifically with a distinctive black colour that resists stains.

| Sizes | Gloves per box | Length | Colour | Glove Exterior |
|------------------|----------------|--------|--------|--|
| S, M, L, XL, XXL | 100 | 245 mm | Black | Textured fingers (XXL glove is fingertip textured only) |



Diamond Grip Plus Latex Glove *Code MFDGP*

For those who prefer powder-free protection and a secure grip, the Diamond Grip Plus glove is the glove of choice. It has textured fingers for exceptional wet and dry gripping. Perfect for every day use, the Diamond Grip Plus is a clean, low odour, high elasticity glove that minimises hand strain. The low modulus latex allows greater manual dexterity and lessened hand fatigue.

| Sizes | Gloves per box | Length | Colour | Glove Exterior |
|-----------------|----------------|--------|--------|----------------|
| XS, S, M, L, XL | 100 | 240 mm | White | Fully textured |



Synetron Plus Latex Glove *Code MFSY*

The Synetron Latex Glove is designed for hazardous work. An interior / exterior polymer coating system provide superior anti-sticking properties that assist with donning in wet, damp or dry conditions. The Synetron Plus offers great film stability and an extended, beaded cuff for greater protection over the wrist and arm, making the Synetron Plus glove technically superior.

| Sizes | Gloves per box | Length | Colour | Glove Exterior |
|-------------|----------------|--------|---------|----------------|
| S, M, L, XL | 50 | 290 mm | Natural | Fully textured |



Safegrip Latex Glove *Code MFSG*

The Safegrip Latex Glove is a powder-free latex glove that has been made for hazardous environments. This glove is four times thicker than standard latex examination gloves. The extended cuff offers added protection against splashes and spills. If you work in a non-medical environment and need a glove with strength, durability and grip, the Safegrip is for you.

| Sizes | Gloves per box | Length | Colour | Glove Exterior |
|-------------|----------------|--------|--------|------------------|
| S, M, L, XL | 50 | 290 mm | Blue | Textured fingers |



Virkon Surface Disinfectant Solution *Codes CPRL-VS (10 x 50 g sachets) and CPRL-VT (10 x 5 g tablets)*

Virkon is the ultimate high level surface disinfectant and provides unequalled protection from infection. It is a working solution that has an exceptional safety profile and is compatible with a wide range of materials including stainless steel, plastics and rubber. Virkon Surface Disinfectant Solution is an easy to use product, which has a broad spectrum of activity; it can be used in a large number of applications and is biodegradable.





Cool Vest RPCM Technology

Heat is part of the job, but it does not have to be part of your life, RPCM Cool Vests provide cooling relief and are suitable for anyone working in warm to extreme temperatures. The cooling properties help you maintain a level head, keep comfortable, and help you retain some energy when you end your work day and head home to the family. The RPCM Cool Vest weighs less than 2.3 kg and maintain a constant and cool 15 C for up to 2.5 hours in ambient temperature of up to 38 C. Cool packs are dry and do not produce condensation leaving you cool, dry and comfortable. RPCM Cool Vests recharge in only 20 minutes in ice water or 30 minutes in the fridge or freezer. The contents are completely non-toxic, non-flammable, safe and environmentally friendly.

Classic RPCM Cool Vest *Code GT-SCV-RB*

The Classic RPCM Cool Vest is hard wearing cotton twill with over the shoulder and side strap adjustment with a heavy-duty front zipper providing maximum ergonomic comfort. Includes RPCM Cool Pack Set. Available in Blue or Desert Camo



High Visibility RPCM Cool Vest

Code GT-SCV-YR (lime green) and GT-SCV-OR (orange)

Ideal for use where high visibility work wear is required. The High Visibility Cool Vest conform s to AS-4602 and features over the shoulder and side strap adjustment with a heavy-duty front zipper providing maximum ergonomic comfort. Includes RPCM Cool Pack Set.



Fire Retardant RPCM Cool Vest *Code GT-SCV-FR*

Constructed from hard wearing, fire retardant materials for welders or hot work applications. Features over the shoulder and side strap adjustment with a heavy-duty front zipper providing maximum ergonomic comfort. Includes RPCM Cool Pack Set.



Concealable RPCM Cool Vest *Code GT-CV265WV*

The Concealable RPCM Cool Vest is designed with concealment in mind and can be worn under regular street clothes. Made with white, machine washable fabric it feature side elastic straps and over-the-shoulder adjustability to fit a wide range of body sizes. Includes RPCM Cool Pack Set.



RPCM Cool Pack Set of Four *Code GT-RSPS15XX*

RPCM Cool Packs come in sets of four, they can be completely recharged in ice water in only twenty minutes or in a refrigerator or freezer in thirty minutes. RPCM Cool Packs are an ideal source of temperature relief as they can maintain a 15° C temperature as long as any portion of the phase change material remains solid.



RPCM Chilly Dog

Code GT-RCCD15XX-A (Chilli Dog Vest and RPCM Packs) and GT-RCCD15XX-B (Chilli Pup Vest and RPCM Packs)

The RPCM Chilly Dog is a powerful cooling device originally designed for defence and law enforcement working dogs. The RPCM Chilly Dog has adjustable buckles and strapping around the chest to ensure a secure and comfortable fit for all sizes of working and domestic dogs. It is available in two sizes.



Acknowledgements

Image on inside cover courtesy DIRA Group Netherlands

Image on page 109 courtesy Climbing Technology Italy

Designer: Choice Creative

Emergency Rescue

Height Safety
Rock Climbing
Mortuary
Engineering

Distributor

Ferno Australia

Head Office
11 Johnstone Road
Brendale Qld 4500
Australia

Call toll free
1800 804 647

p +61 7 3881 4999
f +61 7 3881 1125

VIC
18 Damosh Avenue
Carrum Downs VIC 3201
p +61 3 9775 1260
f +61 3 9775 1360

WA
22 Casella Place
Kewdale WA 6105
p +61 8 9353 2300
f +61 8 9353 1169

www.ferno.com.au