

HORIBA

Instruction Manual

Benchtop pH/ORP Meter
LAQUA-PH1500



LAQUA1500
Benchtop pH - Water Quality Meter

■ Preface

This manual describes the operation of the following instrument.

Brand:	LAQUA
Series name:	Benchtop pH/Water Quality Analyzer
Model:	LAQUA-PH1500
Model description:	pH/ORP Benchtop Meter

Be sure to read this manual before using the product to ensure proper and safe operation of the product. Also, safely store the manual so it is readily available whenever necessary. Product specifications and appearance, as well as the contents of this manual are subject to change without notice.

● Warranty and responsibility

HORIBA Advanced Techno Co., Ltd. warrants that the product shall be free from defects in material and workmanship and agrees to repair or replace free of charge, at option of HORIBA Advanced Techno Co., Ltd., any malfunctioned or damaged product attributable to responsibility of HORIBA Advanced Techno Co., Ltd. for a period of Three (3) years from the delivery unless otherwise agreed in a written statement. In any one of the following cases, none of the warranties set forth herein shall be extended:

- Any malfunction or damage attributable to improper operation
- Any malfunction attributable to repair or modification by any person not authorized by HORIBA Advanced Techno Co., Ltd.
- Any malfunction or damage attributable to the use in an environment not specified in this manual
- Any malfunction or damage attributable to violation of the instructions in this manual or operations in the manner not specified in this manual
- Any malfunction or damage attributable to any cause or causes beyond the reasonable control of HORIBA Advanced Techno Co., Ltd. such as natural disasters
- Any deterioration in appearance attributable to corrosion, rust and so on
- Replacement of consumables

HORIBA Advanced Techno Co., Ltd. SHALL NOT BE LIABLE FOR ANY DAMAGES RESULTING FROM ANY MALFUNCTIONS OF THE PRODUCT, ANY ERASURE OF DATA, OR ANY OTHER USES OF THE PRODUCT.

● Trademarks

- Microsoft, Windows, Windows Vista are registered trademarks or trademarks of Microsoft Corporation in the United States and other countries.

Other company names and brand names are either registered trademarks or trademarks of the respective companies. (R), (TM) symbols may be omitted in this manual.

Regulations

- **Regulations**

- **EU regulations**

- **Conformable standards**

This equipment conforms to the following standards:



EMC:	EN61326-1 Class B, Basic electromagnetic environment
RoHS:	EN IEC 63000 9. Monitoring and control instruments

Warning: This product is not intended for use in industrial environments. In an industrial environment, electromagnetic environmental effects may cause the incorrect performance of the product in which case the user may be required to take adequate measures.

- **Information on disposal of electrical and electronic equipment and disposal of batteries and accumulators**

The crossed out wheeled bin symbol with underbar shown on the product or accompanying documents indicates the product requires appropriate treatment, collection and recycle for waste electrical and electronic equipment (WEEE) under the Directive 2012/19/EU, and/or waste batteries and accumulators under the Directive 2006/66/EC in the European Union. The symbol might be put with one of the chemical symbols below. In this case, it satisfies the requirements of the Directive 2006/66/EC for the object chemical. This product should not be disposed of unsorted household waste. Your correct disposal of WEEE, waste batteries and accumulators will contribute to reducing wasteful consumption of natural resources, and protecting human health and the environment from potential negative effects caused by hazardous substance in products.

Contact your supplier for information on applicable disposal methods.

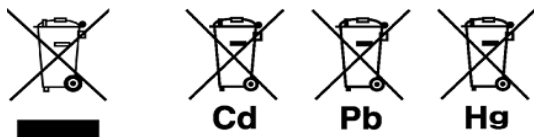

- **Authorised representative in EU**

HORIBA Europe GmbH
Hans-Mess-Str.6, D-61440
Oberursel, Germany

Regulations

• FCC rules

FCC Compliance Statement

This device complies with part 15 of the FCC Rules. Operation is subject to the following two conditions: (1) This device may not cause harmful interference, and (2) this device must accept any interference received, including interference that may cause undesired operation.

Responsible Party for FCC matter

HORIBA Instruments Incorporated
Head Office
9755 Research Drive
Irvine, California 92618 USA
+1 949 250 4811

Note

This equipment has been tested and found to comply with the limits for a Class A digital device, pursuant to part 15 of the FCC Rules. These limits are designed to provide reasonable protection against harmful interference when the equipment is operated in a commercial environment. This equipment generates, uses, and can radiate radio frequency energy and, if not installed and used in accordance with the instruction manual, may cause harmful interference to radio communications. Operation of this equipment in a residential area is likely to cause harmful interference in which case the user will be required to correct the interference at his own expense.

Any changes or modifications not expressly approved by the party responsible for compliance could void the user's authority to operate the equipment.

• Korea certification

B급 기기 (가정용 방송통신기자재)

이 기기는 가정용(B 급) 전자파적합기기로서 주로 가정에서 사용하는 것을 목적으로 하며, 모든 지역에서 사용할 수 있습니다.

Regulations

• China regulation

标记的意义

Meaning of Marking

本标记适用在中华人民共和国销售电器电子产品，标记中央的数字表示环境保护使用期限的年数。（不是表示产品质量保证期间。）只要遵守这个产品有关的安全和使用注意事项，从制造日开始算起在这个年限内，不会给环境污染、人体和财产带来严重的影响。请不要随意废弃本电器电子产品。



This marking is applied to electric and electronic products sold in the People's Republic of China. The figure at the center of the marking indicates the environmental protection use period in years. (It does not indicate a product guarantee period.) It guarantees that the product will not cause environment pollution nor serious influence on human body and property within the period of the indicated years which is counted from the date of manufacture as far as the safety and usage precautions for the product are observed. Do not throw away this product without any good reason.

Regulations

产品中有害物质的名称及含量

Name and amount of hazardous substance used in a product

部件名称 Unit name	有害物质 Hazardous substances					
	铅 Lead (Pb)	汞 Mer- cury (Hg)	镉 Cad- mium (Cd)	六价铬 Hexa- valent chromium (Cr (VI))	多溴联苯 Poly bromobi- phenyl (PBB)	多溴二苯醚 Poly bromo- diphenyl ether (PBDE)
本体 Main unit	×	○	○	○	○	○
AC 适配器 AC adapter ^{*1,*2}	×	○	○	○	○	○
电缆 Cable ^{*2}	×	○	○	○	○	○
支架 Stand ^{*2}	○	○	○	○	○	○
打印机 Printer ^{*2}	×	○	○	○	○	○
电极 Electrode ^{*2}	×	○	×	○	○	○

本表格依据 SJ/T 11364 的规定编制。

This form is prepared in accordance with SJ/T 11364.

○：表示该有害物质在该部件所有均质材料中的含量均在 GB/T 26572 规定的限量要求以下。

Denotes that the amount of the hazardous substance contained in all of the homogeneous materials used in the component is below the limit on the acceptable amount stipulated in the GB/T 26572.

×：表示该有害物质至少在该部件的某一均质材料中的含量超出 GB/T 26572 规定的限量要求。

Denotes that the amount of the hazardous substance contained in any of the homogeneous materials used in the component is above the limit on the acceptable amount stipulated in the GB/T 26572.

*1: 本部件的环保使用期限为10年。 The environmental protection use period of this product is 10 years.

*2: 选配件 Optional products

For Your Safety

- **For Your Safety**

- **Hazard classification and warning symbols**

Warning messages are described in the following manner. Read the messages and follow the instructions carefully.

- **Hazard classification**

 **DANGER**

This indicates an imminently hazardous situation which, if not avoided, will result in death or serious injury. This is to be limited to the most extreme situations.

 **WARNING**

This indicates a potentially hazardous situation which, if not avoided, could result in death or serious injury.

 **CAUTION**

This indicates a potentially hazardous situation which, if not avoided, may result in minor or moderate injury. It may also be used to alert against unsafe practices.

- **Warning symbols**



Description of what should be done, or what should be followed.



Description of what should never be done, or what is prohibited.

For Your Safety

• [DEU] Sicherheitsinformation

Lesen Sie vor der Verwendung des Produkts unbedingt diese Anleitung, um den ordnungsgemäßen und sicheren Betrieb des Produkts zu gewährleisten. Bewahren Sie die Anleitung sicher auf, damit sie bei Bedarf jederzeit zur Hand ist. Die Inhalt dieser Anleitung können ohne Vorankündigung geändert werden.

• Installationsumgebung

Dieses Produkt ist nicht zum Gebrauch in industriellen Umgebungen, wie in EN61326-1 definiert, vorgesehen.

In einer industriellen Umgebung können die elektromagnetischen Störungen eventuell zu Produktfehlfunktionen führen. Um dieses Produkt unter solchen Umständen verwenden zu können, muss der Benutzer ggf. angemessene Maßnahmen ergreifen.

Das Produkt ist gemäß EN61010-1 für die folgende Umgebung vorgesehen.

- Überspannungskategorie II
- Verschmutzungsgrad 2

• [FRA] Informations de sécurité

Veillez à lire le présent manuel avant d'utiliser le produit de manière à garantir son utilisation correcte et sûre.

De même, rangez le manuel dans un lieu sûr de manière à pouvoir vous y reporter lorsque cela est nécessaire.

Le contenu du présent manuel peut être modifié sans notification préalable.

• Environnement d'installation

Ce produit n'est pas destinés à une utilisation dans des environnements industriels, tels que définis dans la norme EN61326-1.

Dans un environnement industriel, les interférences électromagnétiques peuvent entraîner un dysfonctionnement du produit. Pour utiliser le produit dans ce type d'environnements, l'utilisateur peut avoir à prendre des mesures appropriées.

Le produit est conçu pour l'environnement suivant, tel que défini dans la norme EN61010-1.

- Catégorie de surtension II
- Degré de pollution 2

• [ITA] Informazioni sulla sicurezza

Leggere attentamente questo manuale prima di utilizzare il prodotto al fine di utilizzarlo in modo sicuro e adeguato. Inoltre, conservare in un luogo sicuro il manuale per poterlo consultare se necessario.

Le contenuti di questo manuale sono soggetti a modifiche senza preavviso.

For Your Safety

• **Ambiente di installazione**

Questo prodotto non è stato progettato per essere utilizzato in ambienti industriali, secondo la norma EN61326-1.

In un ambiente industriale, le interferenze elettromagnetiche potrebbero causare un malfunzionamento del prodotto. Per utilizzare il prodotto in tali ambienti, all'utente potrebbe essere richiesto di adottare le contromisure necessarie.

Il prodotto è designato per il seguente ambiente, definito nello standard EN61010-1.

- Categoria di sovratensione II
- Livello di inquinamento 2

• **[SWE] Säkerhetsinformation**

Se till att du läser denna handbok innan du börjar använda produkten för en korrekt och säker användning av den. Spara sedan handboken på en säker och lättåtkomlig plats så att du kan konsultera den när så behövs.

Innehållet i denna handbok kan komma att ändras utan föregående meddelande därom.

• **Installationsmiljö**

Detta produkten är ej avsedda för användning i industriella miljöer enligt riktlinjerna i EN61326-1.

Om den används i industrimiljöer kan de elektromagnetiska störningarna orsaka tekniska fel hos produkten. Om produkten ska användas i sådana miljöer kan användaren behöva vidta lämpliga åtgärder för att lösa dessa problem.

Produkten är utformad för användning i följande miljöer, i enlighet med SS-EN 61010-1.

- Överspänningskategori II
- Föroreningsgrad 2

• **[SPA] Información de seguridad**

Asegúrese de leer este manual antes de utilizar el producto para garantizar un uso correcto y seguro del mismo. Asimismo, guarde de forma segura el manual para que esté disponible siempre que sea necesario.

El contenido de este manual están sujetos a cambios sin previo aviso.

• **Entorno de instalación**

Este producto está diseñado para su uso en entornos industriales, tal y como se define en EN61326-1.

En un entorno industrial, las interferencias electromagnéticas pueden provocar un funcionamiento

incorrecto del producto. Para usar el producto en tales entornos, el usuario debe tomar las medidas adecuadas.

El producto se ha diseñado para el siguiente entorno, definido en EN61010-1.

- Categoría de sobretensión II
- Nivel de contaminación 2

For Your Safety

• [POL] Informacje dotyczące bezpieczeństwa

Przed przystąpieniem do użytkowania tego produktu należy dokładnie zapoznać się z niniejszą instrukcją, aby zapewniona była prawidłowa i bezpieczna eksploatacja produktu. Instrukcję przechowywać w bezpiecznym miejscu, aby w razie potrzeby była zawsze dostępna.

Treść niniejszej instrukcji może ulec zmianie bez wcześniejszego powiadomienia.

• Środowisko instalacji

Ten produkt nie są przeznaczone do użytkowania w środowisku przemysłowym, zgodnie z definicją określoną w normie EN61326-1.

W środowisku przemysłowym zakłócenia elektromagnetyczne mogą powodować nieprzewidywalne działanie produktów. Możliwe, że aby użytkować produkt w takich środowiskach, użytkownik będzie musiał podjąć stosowne środki zaradcze.

Produkt jest przeznaczony do użycia w poniższym środowisku zdefiniowanym w normie EN61010-1.

- Kategoria przepięciowa II
- Stopień zanieczyszczenia 2

• [NLD] Veiligheidsinformatie

Lees deze handleiding voordat u dit product gebruikt zodat u het op de juiste manier en veilig kunt gebruiken. Bewaar de handleiding goed zodat u hem wanneer nodig kunt raadplegen.

De inhoud van deze handleiding kunnen zonder voorafgaande kennisgeving worden gewijzigd.

• Installatieomgeving

Dit product is niet bedoeld voor gebruik in een industriële omgeving zoals gedefinieerd in EN 61326-1.

In een industriële omgeving kan de elektromagnetische interferentie de werking van dit product storen. Voor gebruik van het product in een dergelijke omgeving moet de gebruiker mogelijk maatregelen treffen om de storing te verhelpen.

Het product is ontworpen voor de volgende omgeving, gedefinieerd in EN 61010-1.

- Overspanningscategorie II
- Vervuilingsgraad 2

• [JPN] 安全情報

ご使用になる前に、本書を必ずお読みください。お読みになった後は必要なときにすぐに取り出せるように大切に保管してください。

本書に記載されている内容は予告なく変更される場合があります。あらかじめご了承ください。

設置環境

本製品は、EN61326-1 で定義される工業環境で使用することを想定した製品ではありません。

工業環境においては、電磁妨害の影響を受ける可能性があり、その場合には使用者が適切な対策を講ずることが必要となることがあります。

本製品は、EN61010-1 で定義される以下の環境用に設計されています。

- 過電圧カテゴリ II
- 汚染度2

For Your Safety

• Safety precautions

This section provides precautions for using the product safely and correctly and to prevent injury and damage. The terms of DANGER, WARNING and CAUTION indicate the degree of immanency and hazardous situation. Read the precautions carefully as it contains important safety messages.

• Instrument and electrode



WARNING



Do not disassemble or modify the instrument. Otherwise, it may heat up or be ignited resulting in a fire or an accident.



CAUTION



Harmful chemicals

Some electrodes are used with hazardous standard solutions. Handle them with care. The internal solution of pH electrode is highly concentrated potassium chloride (3.33 mol/L KCl). If the internal solution comes in contact with the skin, wash it off immediately. If it gets into the eyes, flush with plenty of water and then consult a doctor.



Broken glass

Broken glass may cause injury. The outer tube and tip of an electrode are made of glass. Handle them with care.



Do not use the phono jack under wet or humid conditions. Otherwise, it may cause a fire, electric shock, or breakage.

Product Handling Information

• Product Handling Information

• Operational Precautions (instrument)

- Only use the product including accessories for their intended purpose.
- Do not drop or physically impact the instrument.
- The instrument is made of solvent-resistant materials but that does not mean it is resistant to all chemicals. Do not expose the instrument in strong acid or alkali solution, or wipe with such solution.
- If the instrument is dropped into water or gets wet, wipe it using soft cloth. Do not heat to dry it.
- Use fingers to press the operation keys. Do not use a hard object like a metal stick or rod.
- Be careful not to let water inside the instrument. The instrument is not waterproof.
- To disconnect an electrode or serial cable, hold the connector and pull it off. If you pull at the cable, it may cause breakage.
- The phono jack communication between the instrument and a personal computer (referred to as PC in the rest of this document) may fail because of environmental conditions, such as electromagnetic noise.
- Do not use an object with a sharp end to press the keys.
- If the power supply is interrupted while measurement data is being saved in the instrument, the data could be corrupted.
- Make sure to use the provided power supply cable to power this product.

• Environmental conditions for use and storage

- Temperature: 0°C to 45°C
- Humidity: under 80% relative humidity and free from condensation

• Avoid the following conditions:

- Strong vibration
- Direct sunlight
- Corrosive gas environment
- Locations close to an air-conditioner
- Direct wind
- Dusty Environment

• Transportation

- When transporting the instrument, repackage it in the original package box. Otherwise, it may cause instrument damage.

• Disposal

- Standard solution used for the calibration must be under neutralized before the disposal.
- When disposing of the product, follow the related laws and regulations of your country for disposal of the product.

Manual Information

- **Manual Information**
- **Description in this manual**

Note

This interprets the necessary points for correct operation and notifies the important points for handling the product.

Tip

This indicates reference information.

Contents

■ Product Overview	1
● Package Content	1
● Key Features	2
■ Basic Operations	7
● Turning On the Instrument	7
● Connecting an Electrode	7
● Changing the Operation Mode	8
● Changing the Measurement Parameter	10
■ Calibration	11
● pH Calibration	11
● ORP/mV Calibration	13
● Temperature Calibration	15
■ Data	17
● Data Capture and Storage	17
● Data Transfer	18
■ Setup	19
● P1 pH Setup	19
● P2 Data Setup	23
● P3 General Setup	27
■ Maintenance and Storage	33
● Maintenance and storage of the instrument	33
● Maintenance and Storage of Electrodes	34
■ Error Messages and Troubleshooting	37
■ Appendix	41

■ Product Overview

This section describes the package content, key features and product components of LAQUA benchtop meters.

● Package Content

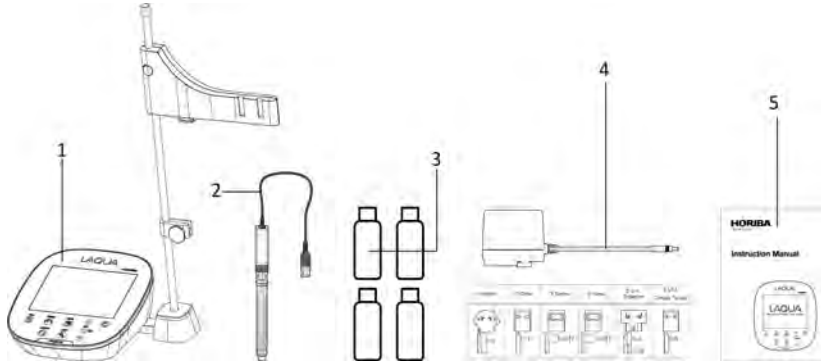

After opening the package, remove the meter and check for damage on the instrument and the standard accessories all exist. If damage or defects are found on the product, contact your dealer.

The LAQUA PH1500 benchtop meter is available in 3 package configurations: PH1500 (meter only), PH1500-S (meter kit with USA pH buffers), and PH1500-SN (meter kit with NIST pH buffers). Refer to the table below for the package contents.



Item	Description	PH1500	PH1500-S	PH1500-SN
1	Meter with integrated electrode stand	Yes	Yes	Yes
2	9625-10D refillable, plastic body pH electrode	No	Yes	Yes
3	pH Buffer Solution Kit	No	502-S USA	501-S NIST
4	Universal power adapter with 6 plugs	Yes	Yes	Yes
5	Manual	Yes	Yes	Yes

● Key Features

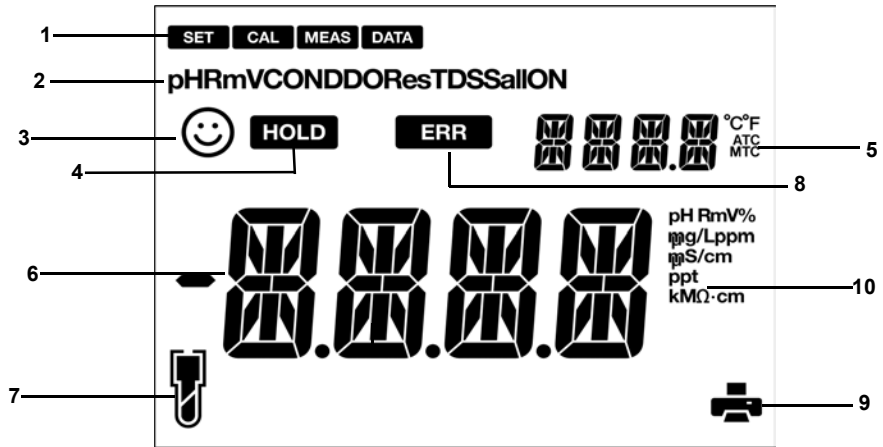

- Large monochrome LCD.
- Integrated electrode holder (up to 2 electrodes) that can be attached to either side of the meter.
- Simple user interface and single parameter display.
- 1000 Memory data.
- Automatic Temperature Compensation (ATC) with temperature calibration.
- Adjustable auto shut-off time (1 to 30 minutes).
- Auto stable, auto hold, and real time measurement modes with reading stability indicators.
- PC (standard USB) / printer (25 pin serial) connection via 2.5 mm diameter phono jack.

• Display











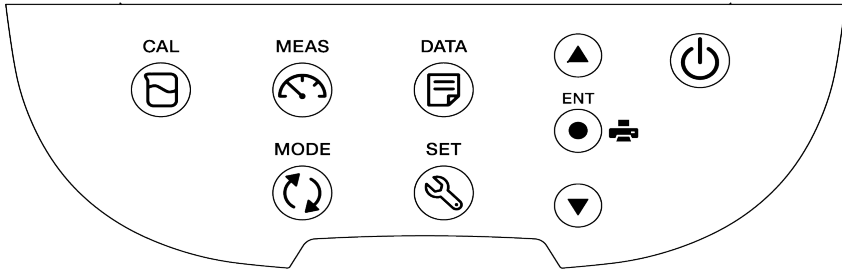

No	Name	Function
1	Status Icon	Displays the current operation mode (Setup, Calibration, Measurement and Data mode)
2	Parameters	Displays the measured parameters like pH, mV
3		Stability indicator shows value is stable for documentation in Auto Stable and Auto Hold modes
4	HOLD	Appears when the measured value display is stable and fixed in auto-hold mode
5	Temperature display area	Displays the measured temperature
6	Measured value, set item display area	Displays the measured value and the set value
7		Indicates electrode sensitivity level
8	ERR	Indicates error situation
9		Indicates data being transferred to the printer or computer
10	pH Rm V% mg/L ppm µS/cm ppt mmol/L kMΩ-cm	Displays the unit for the measurement parameter

● **Electrode Sensitivity Level**

	Electrode sensitivity above 95%(excellent)
	Electrode sensitivity between 85% to 95% (very good)
	Electrode sensitivity between 80% to 85%(good). Refer " SLPE ERR " (page 37) to solve this

• Keypad Operation



Keypad	Name	Function
	CAL key	Switches from the measurement mode to the calibration mode. Starts calibration in the calibration mode.
	MEAS key	Switches the operation mode to the measurement mode. Releases the fixed measurement value mode in the auto hold mode and begins a fresh measurement.
	DATA key	Switches from the measurement mode to the data mode.
	MODE key	In the measurement mode, changes measurement parameters.
	SET key	Switches from the measurement mode to the setup mode.
	ENTER key	Determines the selection or setup. Saves data in the measurement mode and calibration mode.
	UP key	In the setup mode, navigates between various setups. Selects preferred option in some setup screens.
	DOWN key	Increases or decreases selected digit when entering numbers.
	POWER key	Powers ON/OFF the instrument.



■ Basic Operations

This section describes the basic operations such as turning on the instrument, connecting an electrode, and changing the operation modes and measurement parameters of the LAQUA-PH1500 benchtop meter.

● Turning On the Instrument

1. Insert the AC adapter cable by fitting with the AC adapter jack.
2. Insert the AC adapter into the electrical socket.
3. Press the POWER key of the meter.

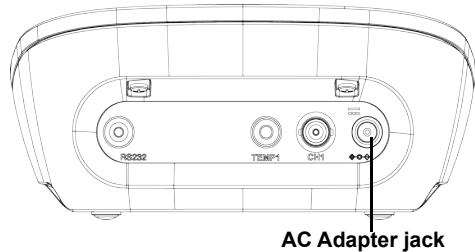

● Connecting an Electrode

To perform calibration/ measurement, it is necessary to use the appropriate electrode for measurement parameter. Use the following procedure to correctly connect the electrode to the instrument:

1. Insert the electrode connector by fitting its groove with the connector pin of the instrument.
2. Turn the electrode connector clockwise by following the grooves.
3. Slide the connector cover on the connector.
4. When using a combination electrode equipped with a temperature sensor, insert the temperature jack (T) to the ATC socket on the meter.

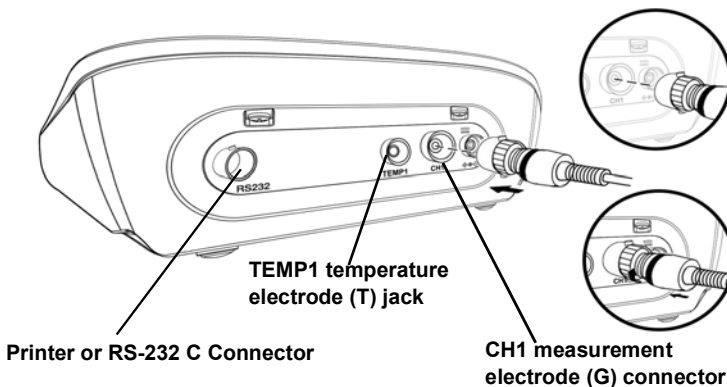





- **Changing the Operation Mode**

You can change the operation mode to four available modes depending on the purpose of use. The status icon indicates the current mode.



Icon	Name	Function
MEAS	Measurement mode	Performs measurement.
CAL	Calibration mode	Performs calibration.
DATA	Data mode	Performs data setup. Displays the saved data.
SET	Setup mode	Perform various setup functions.

You can change the operation mode using the corresponding key:

- **Measurement mode:** Press the  key to change to the measurement mode.
- **Calibration mode:** In the measurement mode, press the  key to change to the calibration mode.
- **Data mode:** In the measurement mode, press the  key to change to the data mode.
- **Setup mode:** In the measurement mode, press the  key to change to the setup mode.

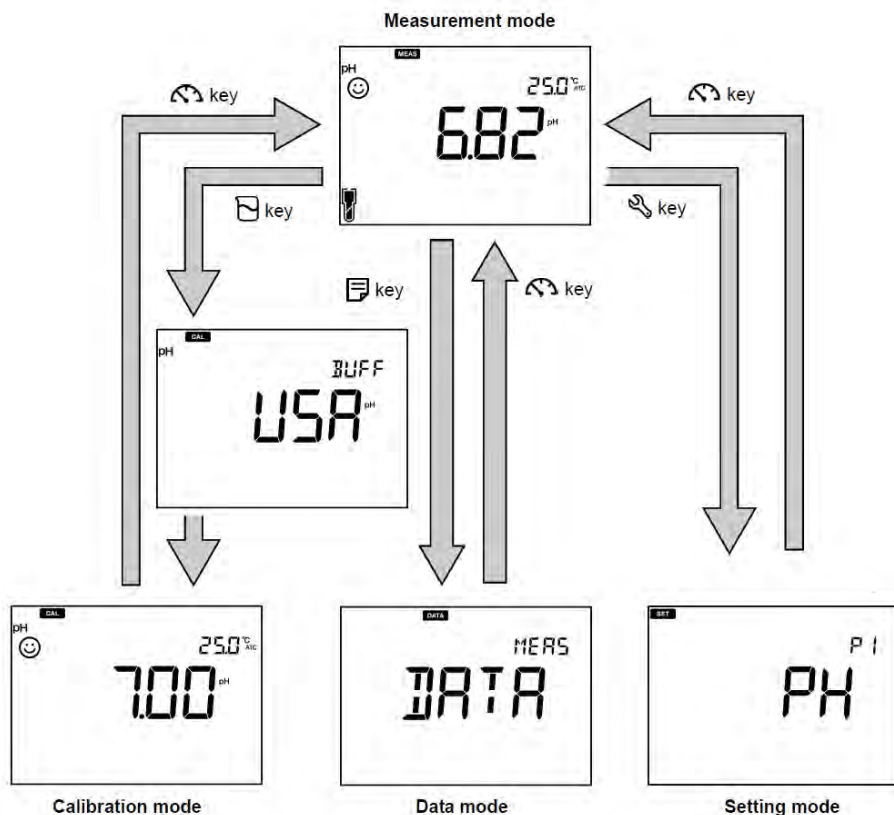

- **Changing the Measurement Parameter**

This instrument measures pH and ORP/mV. For measurement, an electrode corresponding to the measurement parameter is required. In the measurement mode, the measurement parameter can be changed by pressing the  key.

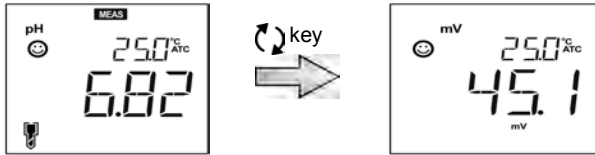

■ Calibration

This section describes the calibration procedures using the LAQUA PH1500 bench meter and electrodes.

● pH Calibration

Calibration is necessary for accurate pH measurement. To perform pH calibration, follow the procedure detailed below:

Prerequisites

- Clean the pH electrode with DI (deionized) water and wipe it with tissue paper.
- Switch on the pH meter and plug in the pH electrode.
- Prepare buffer solution required for calibration.
- Keep the meter in pH measurement mode.
- Dip the pH electrode at least 3 cm in the buffer solution.





Note

- Perform two-point calibration using:
 - pH 7 and 4 for acidic sample.
 - pH 7 and 10 for alkaline sample.
- Perform three-point calibration using pH7, 4 and 10 if you are unsure of the expected sample pH value. It is recommended to calibrate with pH7 first.
- Default buffer setup is **BUFF USA**. If you want to change to **BUFF NIST** or **BUFF DIN**, refer to “P 1.1 Buffer selection” on page 20.

Tip

- To abort an ongoing calibration process at any point of time, press the  key.
 - It is recommended to clear the previous calibration data before performing calibration. For erasing the calibration data, refer to “P 1.3 Erase calibration data” on page 22.
-

Calibration

1. After placing the pH electrode in the buffer solution, press the  key.
2. The selected buffer standard appears on the meter screen and meter starts checking various calibration values with a blinking  on screen.
3. Wait for the  to stabilize (stable calibration reading). When it stabilizes, there will be a sound (from PH1500).
4. Press the **ENT**  key to confirm and save calibration data.
5. Meter displays **DONE** indicating end of the pH calibration procedure.
6. Repeat for other calibration points as required.

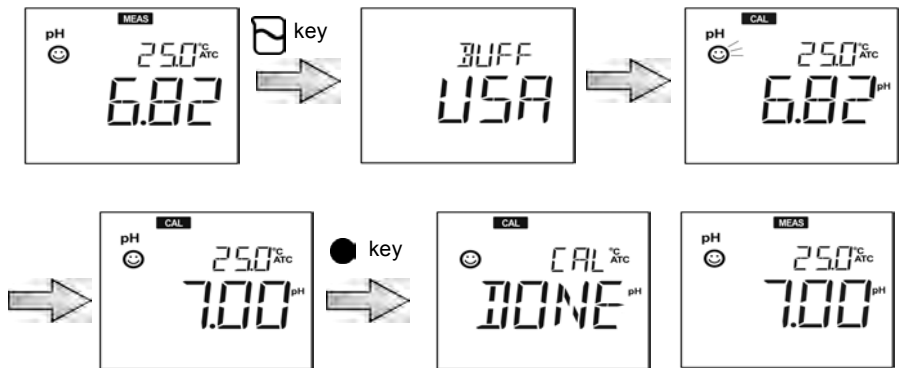

Note

If you want to know previous calibrated values, press the  key when you are in the **CAL** mode. The display scrolls through the calibrated values and indicates slope and offset values.

● ORP/mV Calibration

Calibration is necessary for accurate ORP measurement. To perform ORP calibration, follow the procedure detailed below:

Prerequisites

- Clean the ORP electrode with DI (deionized) water and wipe it with tissue paper.
- Switch on the pH meter and plug in the ORP electrode.
- Prepare standard solution required for calibration.
- Ensure that the meter is in measurement mode.
- Dip the ORP electrode into the standard solution ensuring that the solution level is at least 3 cm from the electrode tip.







Note

- Absolute value measurement mode and relative value measurement mode are the two types of measurement mode available for ORP (mV) measurement.
 - In absolute value measurement mode, the handheld meter displays the actual voltage value.
 - In relative value measurement mode, user can adjust the absolute mV value by calibration. If the mV value is adjusted, the meter automatically indicates relative mV value as **RmV**. The adjustment mV is applied as an offset to the absolute mV value.
 - In the relative mV mode, the absolute mV value can be adjusted by ± 200 mV.
-

Tip

To abort an ongoing calibration process at any point of time, press the  key.

Calibration

1. After placing the electrode in the solution, press the  key to switch to mV mode.
2. Press the  key.
3. Meter starts reading mV values and the  blinks until value stabilizes.
4. Wait for the  to stabilize (stable calibration reading).
5. Use the   keys to adjust the mV value to your desired value.
6. Press the **ENT**  key to confirm and save calibration data.
7. Meter displays **DONE** that indicates end of the ORP/mV calibration procedure.

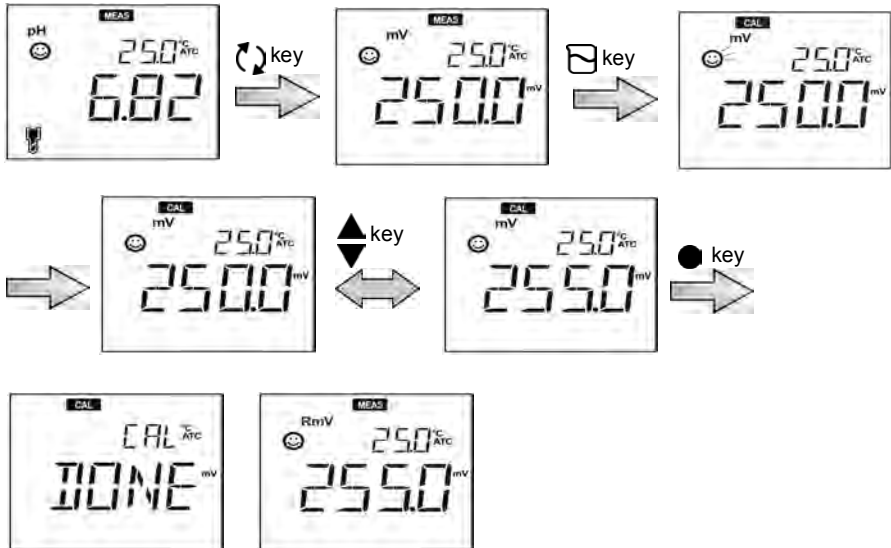

• Temperature Calibration

Temperature calibration is required to accurately match pH electrode to the meter. Check the temperature reading and if it is acceptable, no temperature calibration is required. If you need to calibrate, please follow the procedure detailed below:

Prerequisites

- Clean the pH electrode with DI (deionized) water and wipe it with tissue paper.
- Switch on the pH meter and plug in the pH electrode and temperature sensor.
- Dip the pH electrode in any buffer solution till its temperature sensor is immersed.
- Wait for 5 minutes to ensure temperature stability.





Note

- Meter displays **MTC** if the temperature sensor is not plugged in and displays **ATC** if the temperature sensor is plugged in.
 - Temperature calibration must be performed using a known temperature solution or against a calibrated thermometer.
-

Tip

To abort an ongoing calibration process at any point of time, press the  key.

Calibration

1. After placing the electrode in the solution, press the  key.
2. Press the  key to switch to temperature calibration mode. Meter displays measured temperature value.
3. Use the   keys to adjust the temperature to the required value.
4. Press the **ENT**  key to save calibration data.
5. Meter displays **DONE** indicating end of the temperature calibration procedure.

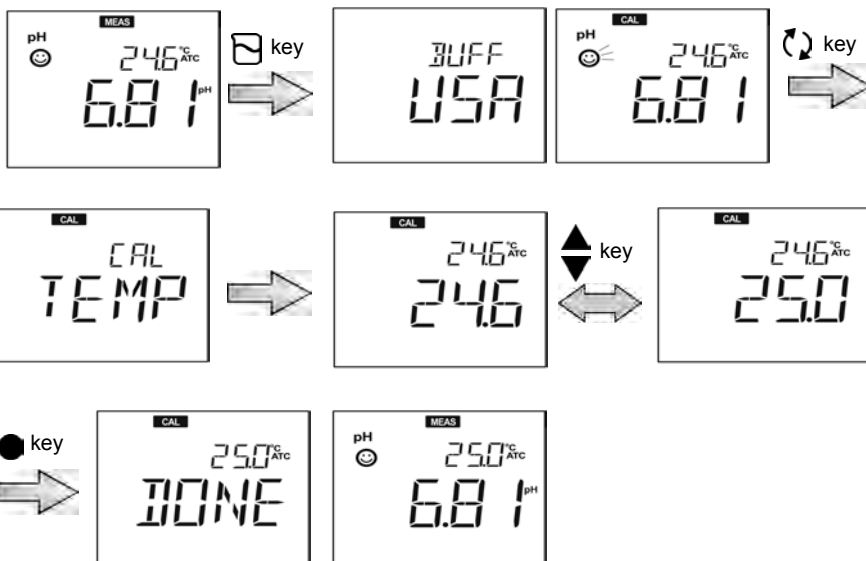

■ Data

This section describes the procedures for storing data into the LAQUA PH1500 bench meter and viewing them as well as transferring data from the meter to a PC.

● Data Capture and Storage

Data measured by the instrument can be stored in the internal memory.

To save the measured data;





- Press the **ENT**  key to save the displayed data.
- Meter displays the saved data for 2 seconds and then the display returns to the previous screen automatically.



Note

- If the data storage limit reaches 1000, memory full error occurs and **MEM FULL** is displayed.
- In such case, print the data or transfer necessary data to a PC and delete the data from the internal memory of the instrument.

Viewing stored data

- To view stored data, press  key .
- Use   keys to review different stored records.
- Press  key to return to measurement mode.

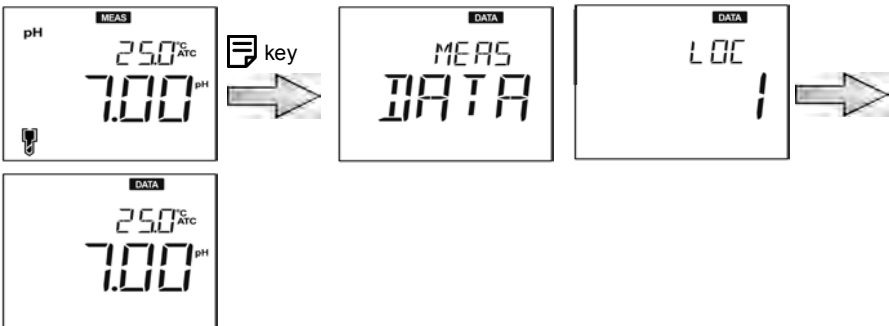





- **Data Transfer**

- **Transfer data to PC**

Connect the instrument to a PC using the phono plug to USB cable to transfer saved data to the PC. Connect the phono jack at the back of the instrument to the communication port on the PC.

- **Print data**

To print a desired data set;

1. When in the measurement mode, press  key.
2. Use   keys to view desired stored data.
3. Press  key to print that individual data.

- **Printer format- data log**

Printer Format – Data Log

Meter Model	: HORIBA PH1500
Serial Number	: 123456789
SW Revision	: 1.00
User Name	:
Signature	:
Logged Data	
Location	: 2
Mode	: pH
pH	: 7.00 pH
mV	: 0.0 mV
Temperature	: 25.0 C (MAN)
Elect. Status	: Excellent

Tip

To print entire stored data log, refer "P 2.2 Print data log" on page 25.

■ Setup

This section describes all the setup functions available in LAQUA PH1500 series handheld meters.

● P1 pH Setup

Using P1 pH setup function of the meter, you can:

- Select buffer standard
- Set calibration alarm
- Erase calibration data

To set the pH functions, follow the procedure detailed below:

Prerequisites

Switch on the pH meter.







Note

- Default buffer setup is **BUFF USA**. You can change it to **BUFF NIST** or **BUFF DIN** if required.
 - Calibration alarm setup option must be used to avoid “Calibration interval alarm error” on page 37 . You can set the calibration alarm for ---- day to upto 90 days, where ---- indicates “no calibration alarm” has been set.
 - Erasing previous calibration data is recommended for accurate calibration. Default setup is **NO** but to erase the calibration data, you need to change the setup to **YES**.
-

Tip





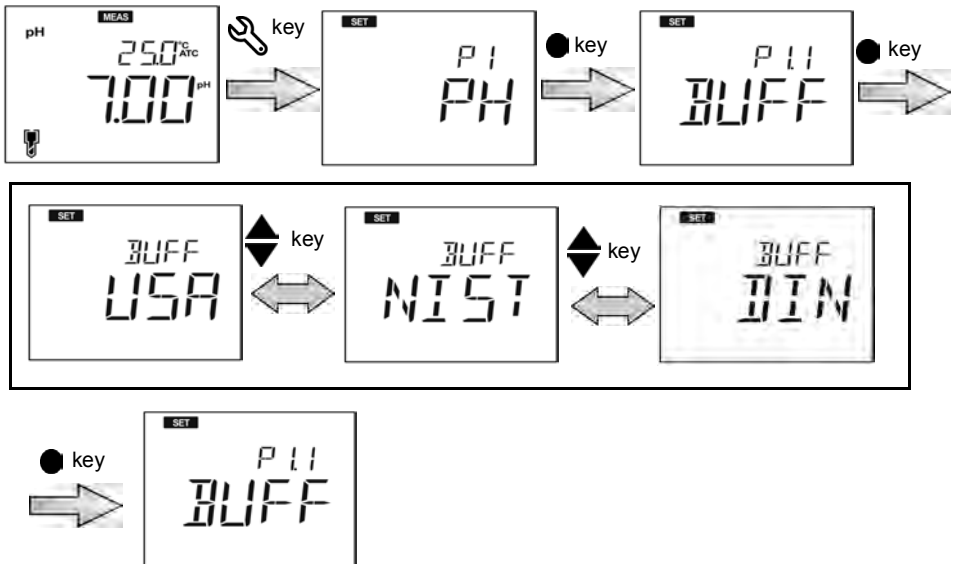

To return to the measurement mode, press the  key.

● **P 1.1 Buffer selection**

1. Press the  key, **P1 PH** screen appears.
2. Press the **ENT**  key, **P1.1 BUFF** screen appears.
3. Press the **ENT**  key, by default **BUFF USA** appears.
4. Use the   keys to change the buffer standard to **BUFF NIST** or **BUFF DIN**.
5. Press the **ENT**  key, **P1.1 BUFF** screen appears. This indicates completion of buffer selection.







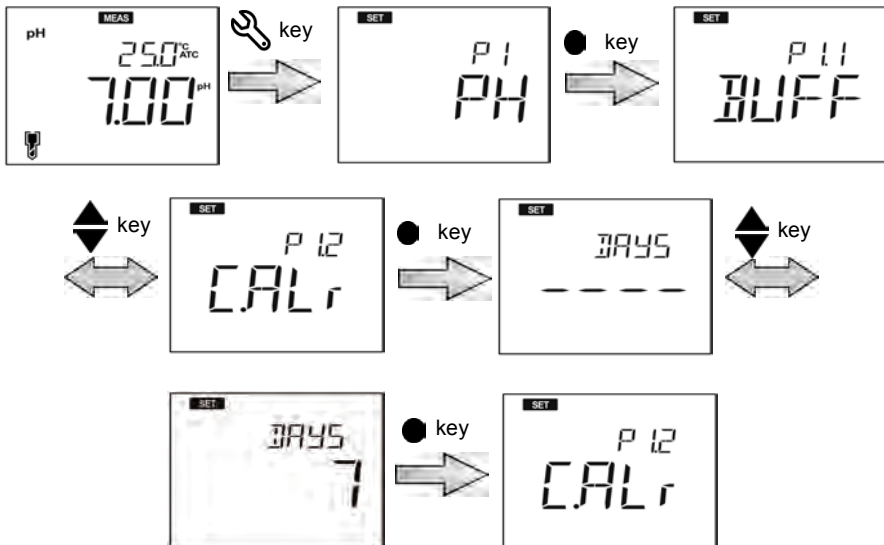



• P 1.2 Calibration alarm setup

1. Press the  key, **P1 PH** screen appears.
2. Press the **ENT**  key, **P1.1 BUFF** screen appears.
3. Press the  key, **P1.2 C.ALr** screen appears.
4. Press the **ENT**  key, by default **DAYS ----** appears.
5. Use the   keys to adjust the calibration alarm interval for next calibration.
6. Press the **ENT**  key, **P1.2 C.ALr** screen appears. This indicates completion of calibration alarm setup.



• P 1.3 Erase calibration data

1. Press the  key, P1 PH screen appears.
2. Press the **ENT**  key, P1.1 BUFF screen appears.
3. Press the  key, P1.2 C.ALr screen appears.
4. Press the  key, P1.3 C.CLr appears.
5. Press the **ENT**  key, C.CLr NO screen appears with NO as default setup.
6. Use the   keys to change the setup to YES. This erases the calibration data.
7. Press the **ENT**  key. P1.3 C.CLr screen appears. This indicates erasure of calibration data.

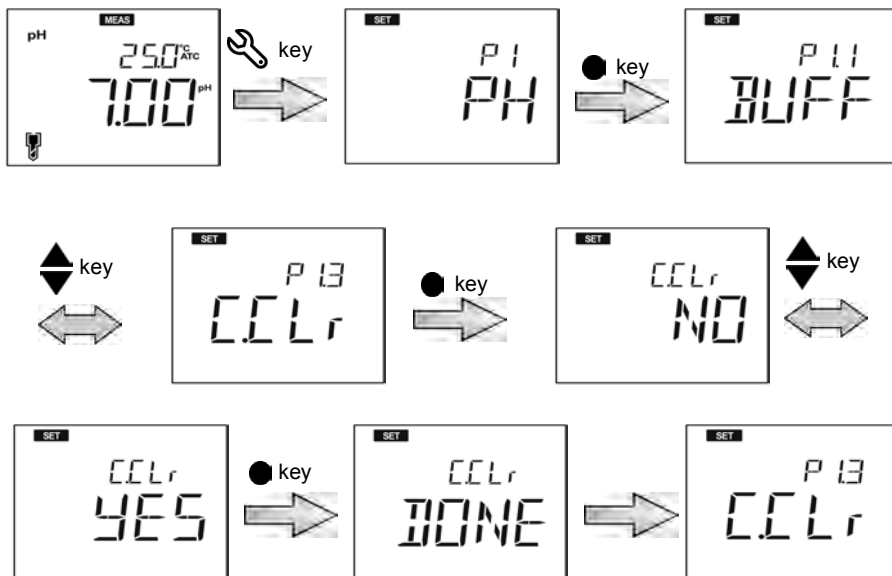

• P2 Data Setup

Using P2 Data setup function of the meter, you can:

- Set data log interval
- Print data log
- Erase data log

To set the data functions, follow the procedure detailed below:

Prerequisites

Switch on the pH meter.







Note

Default data log interval is ____ seconds. Data log interval can be set from 2 to 999 seconds.

Tip







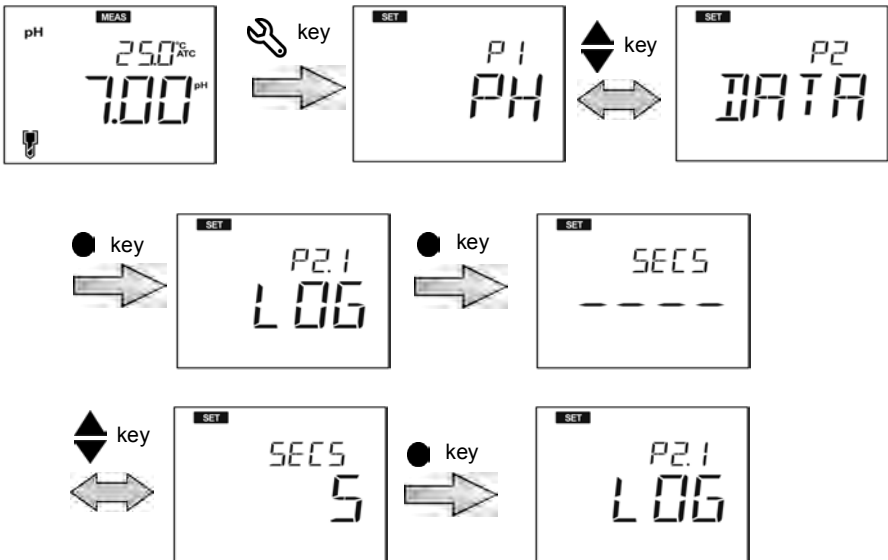

To return to the measurement mode, press the  key.

• P 2.1 Data log interval setup

1. Press the  key, **P1 PH** screen appears.
2. Press the  key, **P2 DATA** screen appears.
3. Press the **ENT**  key, **P2.1 LOG** screen appears.
4. Press the **ENT**  key, previously set log interval appears.
5. Use the   keys to sets the data log interval.
6. Press the **ENT**  key, **P2.1 LOG** screen appears. This indicates completion of data log interval setup.



● P 2.2 Print data log



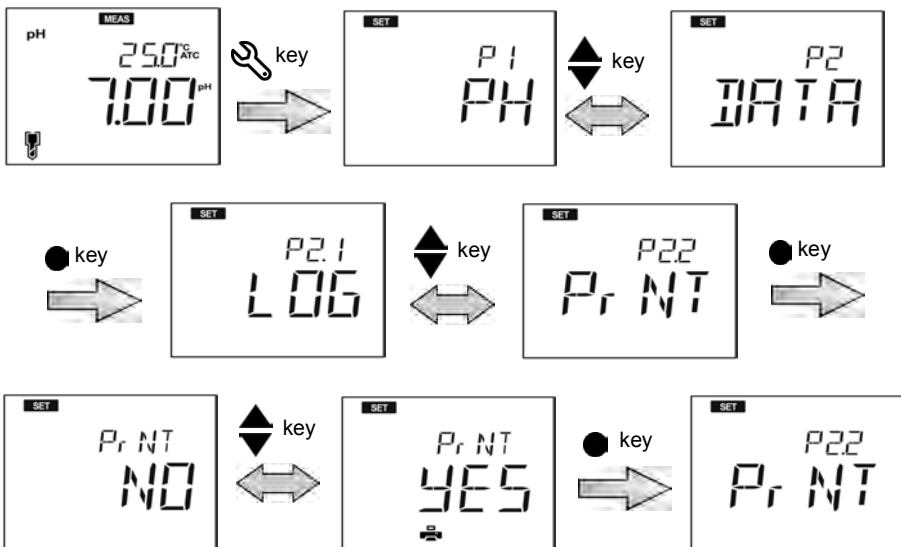





1. Press the  key, **P1 PH** screen appears.
2. Press the  key, **P2 DATA** screen appears.
3. Press the **ENT**  key, **P2.1 LOG** screen appears.
4. Press the  key, **P2.2 PrNT** screen appears.
5. Press the **ENT**  key, default setup is **NO**.
6. Use the   keys to change the setup to **YES**.
7. Press the **ENT**  key, **P2.2 PrNT** screen appears. This indicates completion of the print data.



Tip

To stop the printing process, Press the  key.

● **P 2.3 Erase data log**

1. Press the  key, **P1 PH** screen appears.
2. Press  key, **P2 DATA** screen appears.
3. Press the **ENT**  key, **P2.1 LOG** screen appears.
4. Press the  key, **P2.2 PRNT** screen appears.
5. Press the  key, **P2.3 D.CLR** screen appears.
6. Press the **ENT**  key, default setup is **NO**.
7. Use the   keys set it to **YES** to erase all the data.
8. Press the **ENT**  key, **D.CLR DONE** screen appears briefly and then **P2.3 D.CLR** screen appears. This indicates completion of erasure of data.

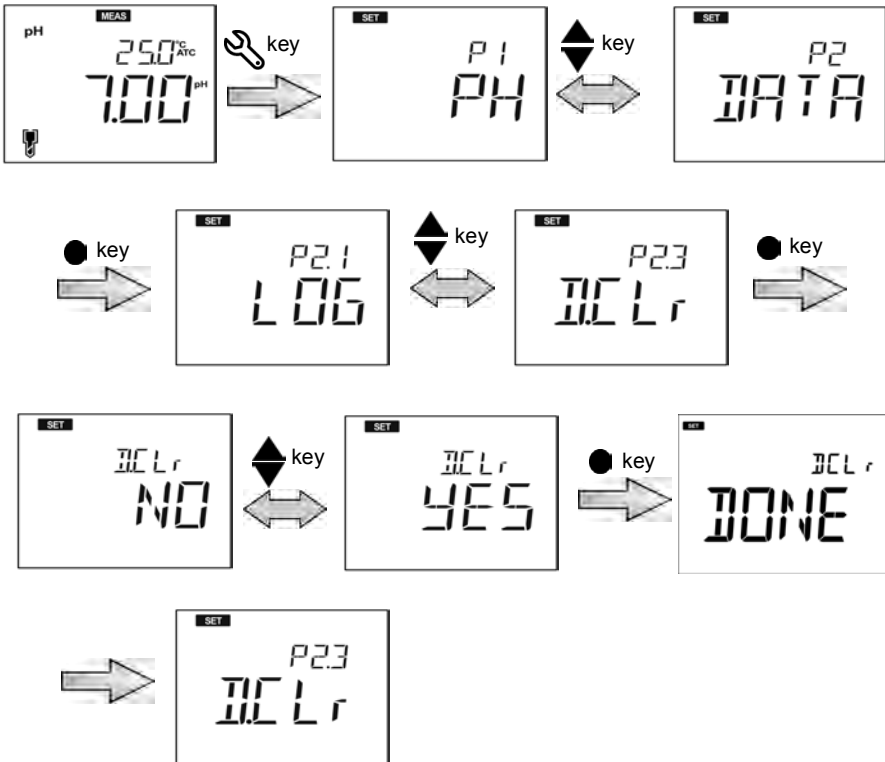

• P3 General Setup

Using P3 General setup function of the meter, you can:

- Select stability mode of the meter
- Set auto shut-off time
- Select temperature measurement
- Reset the meter

To set the general functions, follow the procedure detailed below:

Prerequisites

Switch on the pH meter.

Note

- In the calibration mode, the auto stable (**AS**) mode is activated. Default stability setup in measurement mode is “auto stable” (**AS**). If you like, you can change it to “auto hold” (**AH**) or “real time” (**RT**).
 - Default auto shut-off time is 30 minutes. You can set the time from ---- to 30 minutes, where ---- indicates “no auto shut-off time” has been set and meter will be on continuously.
 - Default temperature unit is °C and you can change the unit to °F.
 - Default reset meter setup is **NO**. If you like to reset the meter, you can change it to **YES**.
-

Tip

- Stability judgment criteria remains same for both auto stability mode and auto hold mode.
 - To return to the measurement mode, press the  key.
-

● **P 3.1 Auto stable, auto hold or real time mode setup**

Auto stable (AS) mode - The meter shows live readings; 😊 annunciator blinks until reading is stable.







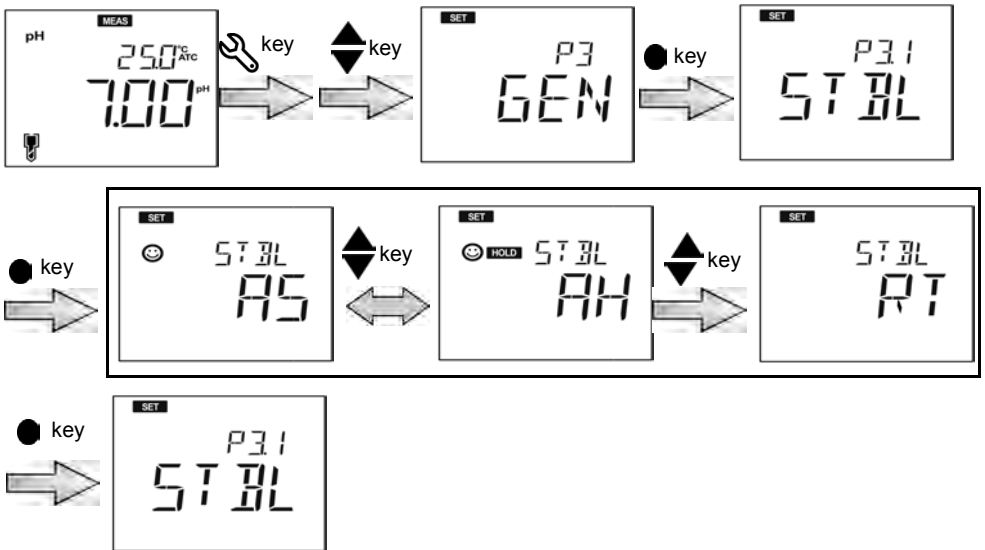

Auto hold (AH) mode - The meter locks the stable reading; 😊 annunciator blinks until reading is stable and then **HOLD** lights up.

Real time (RT) Mode - The meter shows live readings; both 😊 and **HOLD** annunciators are inactivate.

1. Press the 🔧 key, **P1 PH** screen appears.
2. Press ▲ key, **P2 DATA** screen appears.
3. Press ▲ key, **P3 GEN** screen appears.
4. Press the ENT ● key, **P3.1 STBL** screen appears.
5. Press the ENT ● key, Default the stability mode is **AS** (auto stable).
6. Use the ▲ ▼ keys to change the stability mode as **AH** (auto hold) or **RT** (real time).
7. Press the ENT ● key, **P3.1 STBL** screen appears. This indicates completion of the stability mode selection.







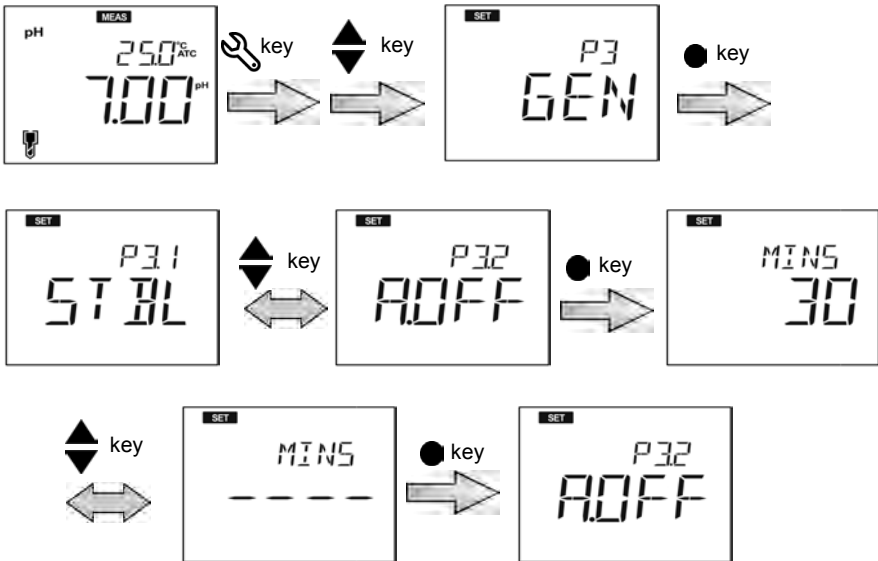





● **P 3.2 Auto shut-off time setup**

1. Press the  key, **P1 PH** screen appears.
2. Press the  key, **P2 DATA** screen appears.
3. Press the  key, **P3 GEN** screen appears.
4. Press the **ENT**  key, **P3.1 STBL** screen appears.
5. Press the  key, **P3.2 A.OFF** screen appears.
6. Press the **ENT**  key, default auto shut-off time is **30 minutes**.
7. Use the   keys to adjust the auto off time.
8. Press the **ENT**  key, **P3.2 A.OFF** screen appears. This indicates completion of the auto shut-off time setup.







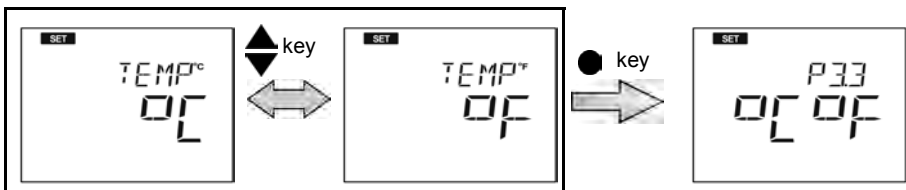
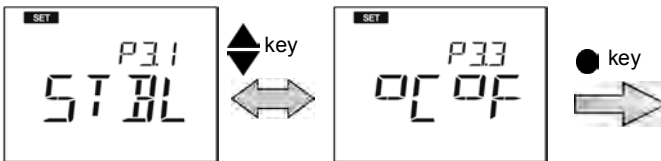
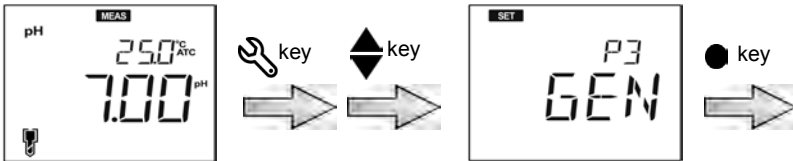





● **P 3.3 Temperature unit setup**

1. Press the  key, **P1 PH** screen appears.
2. Press the  key, **P2 DATA** screen appears.
3. Press the  key, **P3 GEN** screen appears.
4. Press the  key, **P3.1 STBL** screen appears.
5. Press the  key, **P3.2 A.OFF** screen appears.
6. Press the  key, **P3.3°C°F** screen appears.
7. Press the **ENT**  key, default temperature unit is **°C**.
8. Use the   keys to change the unit to **°F**.
9. Press the **ENT**  key, **P3.3°C°F** screen appears. This indicates completion of the end temperature unit selection.



● **P 3.4 Reset meter (factory default)**

1. Press the  key, **P1 PH** screen appears.
2. Press the  key, **P2 DATA** screen appears.
3. Press the  key, **P3 GEN** screen appears.
4. Press the **ENT**  key, **P3.1 STBL** screen appears.
5. Press the  key, **P3.2 A.OFF** screen appears.
6. Press the  key, **P3.3 °C°F** screen appears.
7. Press the  key, **P3.4 r.SET** screen appears.
8. Press the **ENT**  key, default meter re-setup is **NO**.
9. Use the   key to set it **YES**.
10. Press the  key. Meter displays **DONE** and automatically switches off.

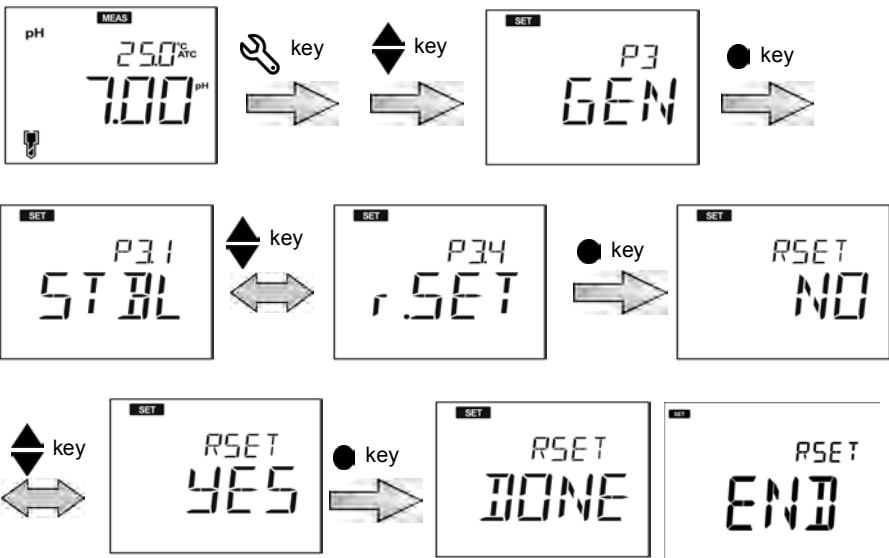

■ Maintenance and Storage

This section describes maintenance of LAQUA PH1500 benchtop meters, pH and ORP electrodes used with the meter.

● Maintenance contract

Please contact your dealer for the product maintenance contract.

● Maintenance and storage of the instrument

● How to clean the instrument

- If the instrument is dirty, wipe it gently with a soft dry cloth. If it is difficult to remove the dirt, wipe it gently with a cloth moistened with alcohol.
- The instrument is made of solvent resistant materials but is not resistant to all chemicals. Do not dip the instrument in strong acid or alkali solution, or wipe it with such solutions.
- Do not wipe the instrument with polishing powder or other abrasive compound.

● Environmental conditions for storage

- Temperature: 0°C to 45°C
- Humidity: under 80% relative humidity and free from condensation

● Avoid the following conditions:

- Dusty place
- Strong vibration
- Direct sunlight
- Corrosive gas environment
- Close to an air-conditioner
- Direct wind

● Maintenance and Storage of pH and ORP Electrodes

This section describes an overview of the procedures for maintenance and storage of pH electrode.

● How to clean the electrodes

When the tip of an electrode (responsive membrane and liquid junction) becomes dirty, the response time may slow or an error may occur in the measurement results. To avoid such errors, clean the electrode. For dirt that cannot be washed off by pure water (or deionized water), use the cleaning solution indicated below depending on the type of dirt. After cleaning, rinse the electrode with pure water (or deionized water).

However for pH and ORP electrodes, different cleaning solutions should be used to clean different types of dirt.

For pH electrode

Type of dirt	Cleaning solution
General	Diluted neutral cleaning solution
Oil	Alcohol, or diluted neutral cleaning solution
Inorganic substance	1 mol/L HCl or electrode cleaning solution
Protein	Cleaning solution including protein-removing enzyme
Alkali	Dip in 1 mol/L HCl or electrode cleaning solution for 1h to 2 h

For ORP electrode

Type of dirt	Cleaning solution
General	Dilute neutral cleaning solution (General dish washing liquid works reasonably well.)
Oil	
Inorganic substance	Immerse dilute nitric acid (1:1 nitric acid)

● **Daily storage of the electrodes**

If the electrode becomes dry, the response will be slow. Store in a moist atmosphere. Follow the steps below to properly store the electrode:

1. Wash the electrode well with pure water (or deionized water) to remove sample completely, and close the internal solution filler port.
2. Wash the inside of the protective cap with pure water (or deionized water), then add enough pure water (or deionized water) to soak the sponge.
3. Attach the protective cap.

Note



When the electrode will not be used for a long period, store it by following the electrode storage procedure detailed above.

■ Error Messages and Troubleshooting

● Error message

This section describes the causes of typical errors and the actions to be taken to resolve respective errors.

If ERR is displayed while you are using the instrument, check the error, its cause and action to be taken in the error list below:

Meter display	ERR description	Cause of error and How to solve the problem
OFFS ERR	Offset voltage error	Electrode is dirty or reference junction is clogged. Clean the electrode.
SLPE ERR	Slope error	Electrode sensitivity is low. Please clean and recalibrate with fresh standard solution. If the problem persists, replace the electrode with new one.
BUFF ERR	Can not auto recognize standard solution	The instrument cannot identify the standard solution. Check the calibration solution and use fresh one if required.
	Calibration interval alarm error	Exceeds the calibration interval setup. Calibrate the meter.
MEM FULL	Memory data full	The number of the data saved has exceeded the specified number of items. Print or transfer the data. Or, clear stored data.
	If user selects the enter key before stable in calibration mode	● key is pressed before the calibration value has stabilized. Wait for the value to be stable and then press the ● key.

● Troubleshooting

This section describes causes and actions to take for problems that customers frequently ask.

The indicated value fluctuates

< Problem with the electrode >

Cause	How to solve problem
The electrode is dirty.	Clean the electrode.
The electrode is broken.	Replace the electrode.
The level of reference electrolyte gel.	Replace the electrode.

< Problem with the instrument >

Cause	How to solve problem
There is a motor or other device causing electrical interference.	Measure at a place where no influence from induction is given. Ground all AC-powered equipment.
The electrode is not connected correctly.	Connect the electrode properly.

< Problem with the sample >

Cause	How to solve problem
Electrode is not immersed enough to cover liquid junction.	The electrode must be immersed up to the liquid junction. As a guide, immerse to at least 3 cm from the tip of the electrode.
The stability of electrode is affected by the sample solution.	It is important to select an electrode that is appropriate for the sample. Consult your dealer. To confirm an electrode that is appropriate for the sample, check the pH electrode selection guide in our catalogue, or refer to our website.

The response is slow

Cause	How to solve problem
The electrode is dirty.	Clean the electrode.
The electrode is broken.	Replace the electrode.
The response of electrode is affected by the sample solution.	It is important to select an electrode that is appropriate for the sample. Consult your dealer. To confirm an electrode that is appropriate for the sample, check the pH electrode selection guide in our catalogue, or refer to our website.

The indicated value does not change**The measured value is out of the measurement range**

When the measured value is below the display range, "Ur" appears. When the measured value is over the display range, "Or" appears.

Cause	How to solve problem
Sample is out of the measurement range.	Use a sample within the measurement range.
Electrode is not immersed enough to cover liquid junction.	The electrode must be immersed up to the liquid junction. As a guide, immerse to at least 3 cm from the tip of the electrode.
The electrode cable is broken.	Replace the electrode.
Calibration is not performed or performed incorrectly.	Perform calibration correctly.
Instrument defect	Check as explained below.

• How to check for instrument defect

Short the metal part of the outer tube to the center pin of the electrode connector of the corresponding channel of the instrument. If “Ur” or “Or” appears in this condition, consult your dealer.



Repeatability of the measured value is poor

Cause	How to solve problem
Effect of the sample solution	Repeatability becomes poor when the pH of the sample changes over time.
The electrode is dirty.	Clean the electrode.
The electrode is broken.	Replace the electrode.
The internal solution of the electrode is partially depleted or contaminated.	Replace the electrode.

Nothing appears when the power is turned ON

Cause	How to solve problem
Instrument defect.	Consult your dealer.

Swelling of keypad

Cause	How to solve problem
Using the instrument at high elevation or other location where the air pressure is different from sea level.	To eliminate the pressure difference between the inside and outside of the instrument, briefly open and then close the serial connector and battery cover. After opening, correctly close the cover to maintain dust and water proofing.
Instrument defect	Consult your dealer.

Part of the display is missing

Cause	How to solve problem
Instrument defect.	Check the display by switching ON the instrument when all the LCD segments are lit.

■ Appendix

● Appendix 1

This section describes technical information and option for LAQUA PH1500 benchtop meter.

pH calibration can be performed according to several buffer standards. The most common standard is the US buffer standard. The default setup is US buffer standard. Alternative standards that can be chosen are NIST and DIN.

The pH buffers are temperature dependent i.e. the pH value changes with change in temperature. The meter is intelligent to detect the temperature and pH value associated with buffer when calibration is performed. It remembers all the temperature vs. pH value for all the standards.

The pH vs. temperature values for the various standards are listed below:

< USA >

Temp. (°C)	pH 1.68	pH 4.01	pH 7.00	pH 10.01	pH 12.46
0	1.67	4.01	7.12	10.32	
5	1.67	4.01	7.09	10.25	13.25
10	1.67	4.00	7.06	10.18	13.03
15	1.67	4.00	7.04	10.12	
20	1.68	4.00	7.02	10.06	12.64
25	1.68	4.01	7.00	10.01	12.46
30	1.69	4.01	6.98	9.97	12.29
35	1.69	4.02	6.98	9.93	
40	1.70	4.03	6.97	9.89	11.99
45	1.70	4.04	6.97	9.86	
50	1.71	4.06	6.97	9.83	11.73
55	1.72	4.08	6.97	9.81	

< NIST >

Temp. (°C)	pH 1.68	pH 4.01	pH 6.86	pH 9.18	pH 12.46
0	1.67	4.00	6.98	9.46	
5	1.67	4.00	6.95	9.39	13.25
10	1.67	4.00	6.92	9.33	13.03
15	1.67	4.00	6.90	9.27	
20	1.68	4.00	6.88	9.22	12.64
25	1.68	4.01	6.86	9.18	12.46
30	1.69	4.01	6.85	9.14	12.29
35	1.69	4.02	6.84	9.10	
40	1.70	4.03	6.84	9.04	11.99
45	1.70	4.04	6.83	9.04	
50	1.71	4.06	6.83	9.01	11.73
55	1.72	4.08	6.83	8.99	

< DIN >

Temp. (°C)	pH 1.09	pH 3.06	pH 4.65	pH 9.23	pH 12.75
0	1.08	3.1	4.67	9.48	13.37
5	1.09	3.1	4.66	9.43	13.37
10	1.09	3.1	4.66	9.37	13.37
15	1.09	3.08	4.65	9.32	13.17
20	1.09	3.07	4.65	9.27	12.96
25	1.09	3.06	4.65	9.23	12.75
30	1.10	3.05	4.65	9.18	12.61
35	1.10	3.04	4.65	9.13	12.45
40	1.10	3.04	4.66	9.09	12.29
45	1.11	3.04	4.67	9.04	12.14
50	1.11	3.04	4.68	9.00	11.98
55	1.11	3.04	4.69	8.96	11.84

Note

Calibration is performed using Nernst's equation with the above values.

- Appendix 2

Printer format - Measurement

pH

Meter Model	:HORIBA PHI 500
Serial Number	:123456789
SW Revision	:1.00
Mode	: PH
pH	: 7.00 pH
Temperature	:25.0 C (MAN)
Elect. Status	:Excellent
User Name	:
Signature	:

mV

Meter Model	:HORIBA PHI 500
Serial Number	:123456789
SW Revision	:1.00
Mode	: mV
mV	: 0.0 mV
Temperature	:25.0 C (MAN)
User Name	:
Signature	:

Relative mV

Meter Model	:HORIBA PHI 500
Serial Number	:123456789
SW Revision	:1.00
Mode	: R. mV
R. mV	: 0.0 mV
Offset	: -3.0 mV
Temperature	:25.0 C (MAN)
User Name	:
Signature	:

Printer format - Data log

Meter Model	:HORI8A PHI 500
Serial Number	:123456789
SW Revision	:1.00
User Name	:
Signature	:
Logged Data	
Location	:2
Mode	:pH
pH	:7.00 pH
mV	:0.0 mV
Temperature	:25.0 C (MAN)
Elect. Status	:Excellent
Location	:1
Mode	:mV
mV	:178.0 mV
Temperature	:25.0 C (MAN)

Printer format - Calibration

pH

Meter Model	:HORI8A PHI 500
Serial Number	:123456789
SW Revision	:1.00
Calibration data	
Cal Points	: 4.01 , 7.00 ,10.01
Offset	: 0.0 mV
Avg Slope	: 98.2 %
Cal Temp.	: 25.0 C (ATC)
Elect. Status	: Excellent
User Name	:
Signature	:

• Meter Specifications

Specifications	LAQUA-pH1500
pH range	- 2.00 to 16.00
pH resolution	0.01
mV	-2000 to 2000
mV resolution	0.1mV(+999.9mV); 1mV (other)
ORP cal	Yes (+/- 200mV)
Temperature	-30 to 130 C/ -22 to 266 F
Temp. resolution	0.1
Temp Cal	Yes (+/- 10 degrees)
Display	Static LCD; no back light; 160 segments
Channel	1CH
Data memory	1000
Communication	Phono jack (RS232/USB)
Power	110V/220V

HORIBAAdvanced Techno

31, Miyanonishi-cho, Kisshoin Minami-ku, Kyoto 601-8306, Japan
<http://www.horiba-adt.jp>

For any questions regarding this product, please contact your local agency, or inquire from the following website.
http://global.horiba.com/contact_e/index.htm

Manual: LAQUA-PH1500/1500-S/1500-SN =E=
P/N: 3200869207
GZ: GZ0000622466-