



# Technical Manual & Trade Price Guide

Australian Product Range



 1800 810 803

 [sales.au@rwc.com](mailto:sales.au@rwc.com)

 [johnguest.com](http://johnguest.com)



Reliance Worldwide Corporation (Aust.) Pty. Ltd.  
27-28 Chapman Place, Eagle Farm QLD 4009,  
Australia | ABN 71 004 784 301

## Introduction

Terms, Conditions and Warranty	1
About John Guest	2
The John Guest Range	3
WaterMark Details for Australian Product	5
Non-Watermarked Product Tested to AS/NZS 4020	5
International Standards	5

## Speedfit Twist and Lock Range

Speedfit Twist and Lock Technical Specifications	7	
How To Make A Connection - Speedfit Twist and Lock Fittings	9	
Speedfit Twist and Lock Fittings	WaterMarked range of domestic plumbing fittings	11

## Speedfit Fittings, Valves and Tubing

Speedfit Technical Specifications	15
How To Make A Connection - Speedfit Range	18
Pipe Stop Distances	19
Collet Covers and Collet Clips	19
Typical Bar Installation	20

### Imperial Fittings

Grey Acetal Fittings – PI Range	Liquids and inert gases	21
White Acetal Fittings – CI Range	Pure water and other potable liquids	32
White Polypropylene Fittings – PP Range	Pure water and a wide range of applications	35
Superseal Fittings – SM & SI Range	For use with stainless steel tube	39
Brass Fittings – MI Range	Beverage dispense applications	41

### Metric Fittings

Acetal Fittings – CM Range	Drinks and other potable liquids	42
Black Acetal Fittings – PM Range	Liquids and inert gases	43
White Polypropylene Fittings – PPM Range	Pure water and a wide range of applications	51

### Metric to Imperial Adaptors

Metric to Imperial Adaptors	Converts metric sizes to inch and inch sizes to metric	52
-----------------------------	--	----

### Valves, LLDPE Tube and Accessories

Acetal Stop Valves	White and grey acetal – Angle and Elbow Stop Valves	53
Shut-Off Valves	White polypropylene and grey acetal Shut Off Valves	54
Check Valves and Service Valves	Single and Double Check Valves and Service Valves	56
LLDPE Tube – PE Range	Strong yet flexible tubing	59
Accessories	From Collet Covers to Tube Cutters	61

## Speedfit Compressed Air System

Speedfit Compressed Air Technical Specifications	65	
How To Make A Connection - Speedfit Compressed Air Fittings	67	
Installing A Speedfit Compressed Air System	69	
Black Acetal Fittings – PM Range	12mm-28mm fittings for compressed air systems	70
Brass Fittings – MM Range	Compressed air systems	73
Brass Fittings – RM Range	Pneumatic air line applications	74
Speedline Pipe and Accessories	Rigid nylon pipe and accessories	75



## Pricing

List Price is per unit. All prices exclude GST.

## Terms and Conditions

No party should rely upon the contents of this publication as to the fitness of any particular product for any particular use or application. Goods are offered with the benefit of the manufacturers Warranty. Reliance Worldwide Corporation (AUST.) Pty Ltd. shall not be liable for any loss or damage either direct or consequential arising from any defect.

RWC reserves the right to modify designs and specifications and to withdraw and introduce products at any time without notice.

No part of this publication may be reproduced, copied or transmitted in any form by any means graphic, electronic or mechanical (including photo-copying, recording, taping or by any information storage and retrieval system) without prior permission in writing of the publisher Reliance Worldwide Corporation (Aust.) Pty. Ltd.

## Installation

Installation is subject to the requirements of the applicable regulatory authority, the National Construction Code Volume Three – Plumbing Code of Australia, associated reference standards as applicable at the time and AS/NZS 3500.

## Reliance Worldwide Corporation Warranty

Reliance Worldwide Corporation (Aust.) Pty. Ltd. (RWC) will either replace or repair any defective goods where the defect arose as a result of manufacture for up to twenty-five (25) years for WaterMarked products, and one (1) year for non-WaterMarked products (see [www.rmc.com.au/warranty](http://www.rmc.com.au/warranty) for more details). You may contact RWC at the phone number, address or e-mail shown below and will be required to return the goods for evaluation. Should the defect be found to be one of our manufacture we will send you a replacement product to your stated address at our expense. Our goods come with guarantees that cannot be excluded under Australian Consumer Law. You are entitled to a replacement or refund for a major failure and for compensation for any other reasonably foreseeable loss or damage. You are also entitled to have the goods repaired or replaced if the goods fail to be of acceptable quality and failure does not amount to a major failure.

® = Registered Trade Mark of  
Reliance Worldwide Corporation (Aust.) Pty. Ltd.  
27-28 Chapman Place, Eagle Farm QLD 4009, Australia  
1800 810 803 | [sales.au@rwc.com](mailto:sales.au@rwc.com)

© 2022 All rights reserved



## About John Guest

When Mr. John Guest first opened his factory doors in the UK in 1961, he was determined to run a company where quality of product and excellence of service underpinned its ethos.

A strong spirit of innovation was encouraged from the outset, which led to the development and invention of the first Speedfit push-to-connect fittings in the 1970's by John Guest himself.

Today, John Guest has a long established reputation as a world leading manufacturer of push-to-connect fittings, tubing and other fluid control products. A reputation built on producing consistently high quality products with an ongoing commitment to value engineering and product development.

The world's first food-quality push-to-connect fitting, the John Guest range is now over 800 items strong and provides the quickest and most effective of installations. Pushing the tube into the fitting is all that is needed to produce an instant but permanent leakproof connection.

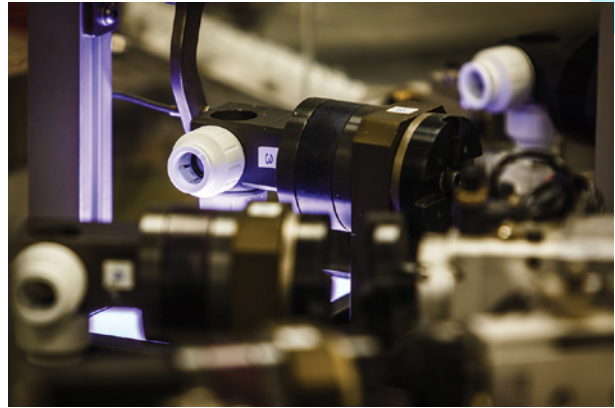

## Quality Manufacture

**A commitment to quality is at the heart of the John Guest philosophy.**

The strictest control is maintained by virtue of the fact that design and manufacture is carried out in modern purpose built manufacturing centres in West London and at Maidenhead in Berkshire.

Maintaining control over the whole process from initial tool design and tool making, through to final assembly and testing, ensuring that only products of the highest quality are produced.

The company believe it is this commitment to quality that has led to it receiving prestigious awards from many of the world's leading testing and approvals organisations.

John Guest is a preferred supplier to many international companies.



**Fast Installation Time  
'Right First Time Every Time'**



**Quick Disconnection**

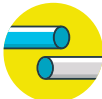

**Suitable For Soft Metal  
or Plastic Tubes**



**Re-Usable**



**No Tools Needed**

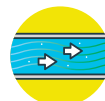

**Superior Flow Characteristics**

## The John Guest Range



### Speedfit Twist and Lock Range Plumbing Fittings

The Twist and Lock range of WaterMarked plumbing fittings were designed for use in normal domestic plumbing applications in accordance with 'AS/NZS 3500', 'AS 4176 (ISO 15875/21003)'. The 12mm range is popular with the caravan and motorhome market.

An additional benefit the Twist and Lock range offers is that a twist of the screw cap locks the pipe into place and gives increased compression on the O-Ring for even greater security.



### Grey Acetal Imperial (PI) and Black Acetal Metric (PM) Fittings

The PI and PM range of fittings are manufactured from an acetal copolymer with food grade nitrile O-Rings. Being especially produced for foodstuffs and potable liquids, they are equally suitable for air and inert gases and can therefore be used on N<sub>2</sub>/CO<sub>2</sub> mixed gas dispense lines and pneumatic and vacuum applications.



### White Acetal Imperial (CI) and Acetal Metric (CM) Fittings

Manufactured from an acetal copolymer with food grade EPDM O-Rings, the CI and CM range have been developed for the water purification/filtration industry, but are equally suitable for other potable liquids. They are also recommended for intermittent hot water applications. The CI and CM Fittings are NOT suitable for compressed air and vacuum applications.



### White Polypropylene Imperial (PP) and Metric (PPM) Fittings

The PP range of push-to-connect fittings is produced in white polypropylene and fitted with EPDM seals. Developed for the water industry, they also suit a wide range of applications. Polypropylene has the advantage of being more chemically resistant than acetal.



### Superseal Imperial (SI) and Metric (SM) Fittings

Designed to provide extra grip on hard steel, stainless steel and other polished metal tubing, the Superseal range features a collet with integrally moulded stainless steel teeth. It is similar to the standard Speedfit design, but incorporates an additional hand-operated nut and wedged shaped plastic washer to apply extra pressure to the collet and the double O-Ring seals. Superseal is suitable for potable liquids and other food quality applications.



### Brass Fittings (MI) – Beverage Dispense Applications

The MI range of brass fittings are manufactured in brass with a polypropylene collet and a food grade EPDM O-Ring and are designed for use in coffee brewing equipment, dispensing and vending machine applications.



### Brass Fittings (RM) – Pneumatic Air Line applications

The RM range of brass fittings are suitable for pneumatic air line systems. Suitable for plastic and soft metal piping. The Straight Male Adaptor features a SuperThread, a unique thread seal developed by John Guest to enable male adaptors to be used with a variety of female thread forms.



### Metric/Imperial Adaptors

Manufactured from a range of compounds to suit your needs, Metric/Imperial adaptors are designed to extend the range of John Guest Speedfit products that can be combined together in one system.



### Valves

Manufactured from a range of compounds to suit your needs and designed to offer a variety of control measures, the John Guest range features Stop Valves, Shut Off Valves, Check Valves and Service Valves.



### LLDPE Tubing

John Guest LLDPE tubing provides the benefits of a wide range of temperature and pressure suitability, broad chemical compatibility, it is made from FDA approved materials and is NSF international certified. Common applications are water filtration, ice makers and misting systems and is recommended for use with cold water and intermittent hot water applications.



### Compressed Air Systems

Push-to-connect fittings and pipe means a compressed air system can be installed quickly and easily with substantially reduced production down time. It is also easy to rearrange and extend a system.





### WaterMark Details for Australian Product

The WaterMark license has been applied to the John Guest Speedfit Twist and Lock Range – see the relevant chapter in this Technical Manual for a full list of WaterMarked products.

All John Guest products should be installed as per the installation instructions and within the prescribed operation conditions as detailed in the appropriate technical manual section. Failure to ensure proper installation methods and operating conditions may result in a shortened operating life and or voiding of the product warranty.



### Non-Watermarked Product Tested to AS/NZS 4020

All John Guest potable water products are certified to AS/NZS 4020 for use in contact with potable water. Products that have not been certified to Australian standards through the WaterMark scheme are not suitable for installation within a plumbing system covered as AS/NZS 3500. All John Guest products that do not have a WaterMark approval are to be used in a serviceable location and must not be used in behind-the-wall applications.

The only exception to this is where a John Guest product is utilised as a sub-component in another manufacturer's product that carries an appropriate WaterMark certification.

All John Guest products should be installed as per the installation instructions and within the prescribed operation conditions as detailed in the appropriate technical manual section. Failure to ensure proper installation methods and operating conditions may result in a shortened operating life and or voiding of the product warranty.

Installations may be subject to the requirements of the applicable regulatory authority, the National Construction Code Volume Three – Plumbing Code of Australia, associated reference standards as applicable at the time and AS/NZS 3500.

### International Standards

Accepted by almost all the world's beer and beverage producers and by the manufacturers of drinks dispense equipment, John Guest products have quality and performance approvals from leading testing and acceptance authorities.

Speedfit products are designed and manufactured under a fully integrated system assessed by B.S.I to BS EN ISO9001. They are approved by IAPMO Oceana for hot and cold water use (ISO15875/21003).



### Food Contact Approvals

NSF 51 listed fittings in this brochure are produced in Food and Drug Administration (FDA) compliant materials and are therefore recommended for food quality applications. The majority of fittings in this catalogue are also supported by a John Guest declaration of compliance to European Regulation (EC) no.1935/2004.

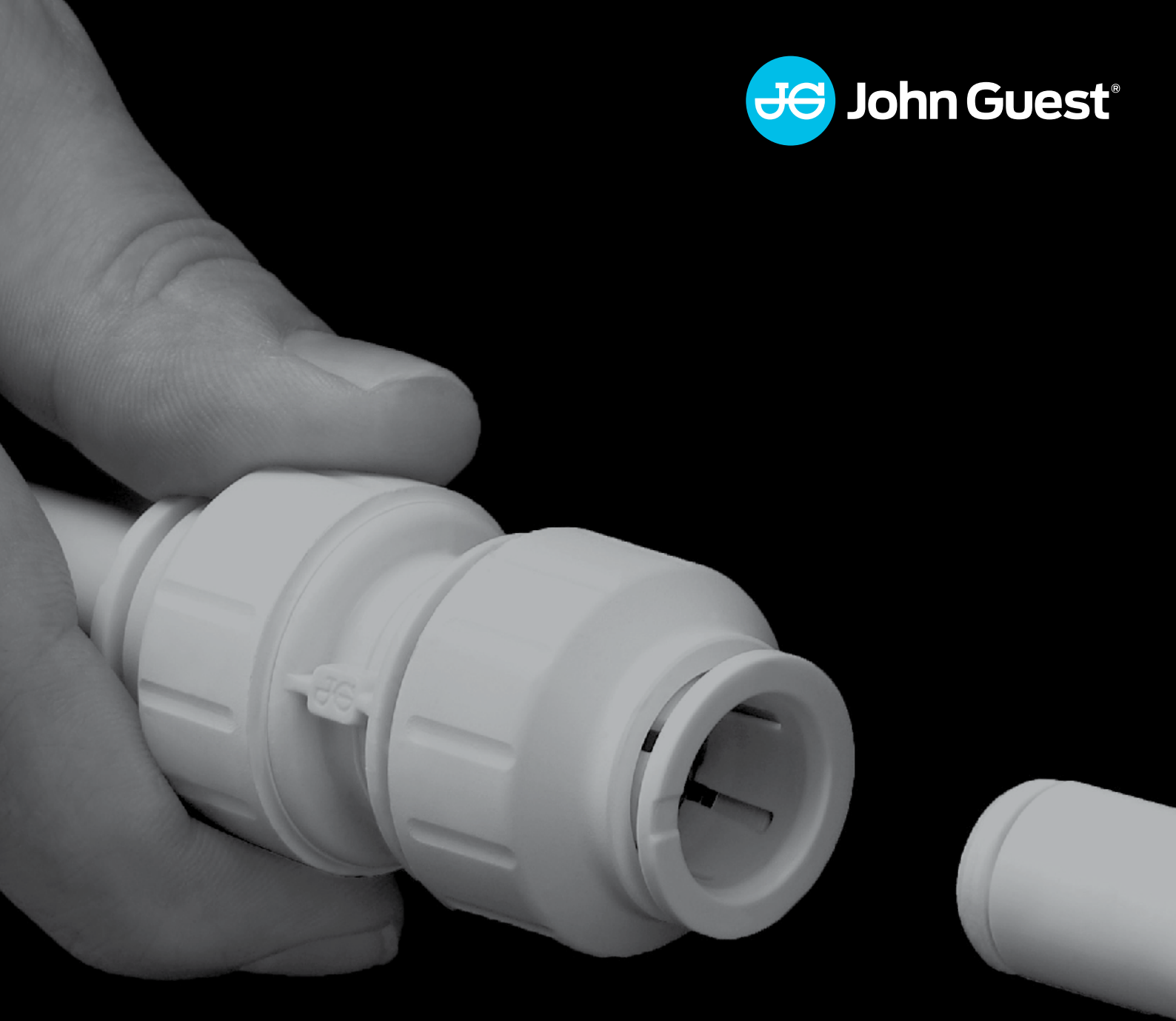

# Speedfit

Twist and Lock Range

## Speedfit Twist and Lock Technical Specifications

Fittings and pipe should be kept clean and undamaged before use.

### Approved Applications

The John Guest Speedfit Twist and Lock range has WaterMark certification to AS 4176 'Multilayer Pipe and Fitting Systems for Hot and Cold Water Plumbing Applications'.



### Sizes

12mm outside diameter (OD) pipe.

### Installation

Always refer to AS/NZS 3500 when installing any John Guest hot and cold plumbing systems, and ensure that any installation is performed in accordance to the requirements of the standard. However, the installer should also be aware of local authority codes and by-laws relevant to plumbing, which take precedence over these guidelines in any area where they vary.

### High Temperatures

In case of malfunction, the Speedfit Twist and Lock system can withstand 100°C intermittently for short periods. The Speedfit Twist and Lock system should not be used on an uncontrolled heat source.

### Minimum Bend Radii (BPEX)

Pipe OD	Minimum Radius	Minimum Radius With Cold Forming Bend
12mm	120mm	55mm

### Clip Spacing

For surface mounted pipes. Where pipe is concealed, clipping may only be required where necessary.

Pipe OD	Clip Spacing	
	Horizontal Run	Vertical Run
12mm	300mm	500mm

### Expansion (PEX pipe)

1% on length between 20°C and 82°C.

### Pipe Clips

Pipe clips should not be fitted any closer than 60mm from the end of the fitting. Pipe should be adequately supported by pipe clips to prevent undue stress (side load) on fittings.

### Pipe Inserts

Pipe inserts must be used on all installations when using plastic pipe and should be fully inserted. Only use a Speedfit insert with Speedfit pipe.

### Paint and Chemicals

Before using Speedfit fittings and pipe with chemicals or other potentially aggressive liquids, please contact our Customer Service Department.

Use only water or oil based paint. **Do not allow contact with** jointing compounds, cellulose based paints, paint thinners or strippers, solder flux, acid based descalents, or aggressive cleaning products, including those below pH4, high in hypochlorite (e.g. bleach), or containing hydrogen peroxide.

### UV Resistance

Speedfit products should **not** be installed in direct or reflected sunlight as the material may degrade with extended UV exposure.

### Brazing Flux

No fluxes of any type should come into contact with Speedfit fittings or pipe.

### Copper Capillary Adaptors

Braze a Speedfit copper capillary adaptor to the copper pipe and allow capillary joint to cool completely, making sure that the Speedfit stem end is free of any flux, or other contaminant, before inserting any Speedfit fittings.

### Chlorine

Speedfit Twist and Lock is not suitable for use in systems where the water contains high levels of chlorine. E.g. swimming pools, fountains, etc.



## Metal Joists

When 'cabling' plastic pipe through metal joists, ensure rubber grommets are in place to prevent damage to pipe. Use of collet clips on standard fittings is recommended.

## Connection to Water Heaters

Not to be used beyond the inlet stop valve, and within 1 metre of the outlet of the water heater.

## Connection to Copper Pipe

450mm is the minimum distance to make a brazed connection on copper pipe where brazing tails are inserted into Speedfit connectors. Ensure that any residual flux does not come into contact with the fitting.

## Concrete and Masonry

Speedfit pipe and fittings can be laid in concrete and masonry, providing they are installed in conduit pipe with access boxes for the fittings. This is to enable the pipe to expand and provide accessibility for both pipe and fittings. Fittings and pipe should be removable for possible replacement. Insulation is also recommended to protect against heat loss and the effects of frost.

## Electrical Continuity

If Speedfit is used in an existing metal system which may have been used for earthing, electrical continuity should be reinstated.

## Collet Clips

Collet Clips prevent accidental release of pipe from non-Twist and Lock fittings, i.e. stop ends and brass fittings. Red and blue clips can also be used to provide colour coding of pipe on both Twist and Lock, and other Speedfit fittings.

## Re-Circulating Ring Main Systems

Speedfit products must not be used on any re-circulating ring main systems, as they are not approved under the current standards.

## System Testing

To ensure the pipe work and fittings have been installed correctly, whether it be on a new or extended system, it is essential that the system is checked, and hydraulically wet tested. Testing should be at 200kPa for 10 minutes, and as per AS 350016.3.1, requiring the plumbing system to be tested to 1500kPa for at least 30 minutes.

## System Flushing

As is usual practice for any plumbing installation, flushing of the system prior to the use of Speedfit is recommended to remove any contaminants/chemical residue from elsewhere in the system.

## Vermin

Speedfit products should not be used in vermin infested areas.

## Maximum Torque Figures

Plastic threads are not generally as strong as brass threads. Customers and end users should be aware of this when choosing products for their applications. Over tightening of plastic threads will cause undue stress and eventual cracking and leakage. The maximum torque figures for BSP, and BSPT threads, used on Speedfit plumbing products, in mating threads, conforming to the relevant British or International thread standards, are as follows:

Threads	Size	Maximum Torque
Brass	1/2"	4.0 Nm
Brass	3/4"	5.0 Nm

It is recommended that all installations are checked prior to use to determine that seal has been made.

## How To Make A Connection – Speedfit Twist and Lock Fittings

Speedfit Twist and Lock fittings have a unique grip-then-seal construction, made up of a collet with stainless steel teeth, to grip the pipe, and an O-Ring to provide a permanent leak proof seal.

When connecting Speedfit pipe to a Speedfit Twist and Lock fitting, be sure to always use a pipe Insert.

The head of the insert has been designed for ease of insertion.

The additional benefit of Speedfit Twist and Lock fittings is that a twist of a screwcap locks the pipe in position and gives increased compression on the O-Ring for even greater security.

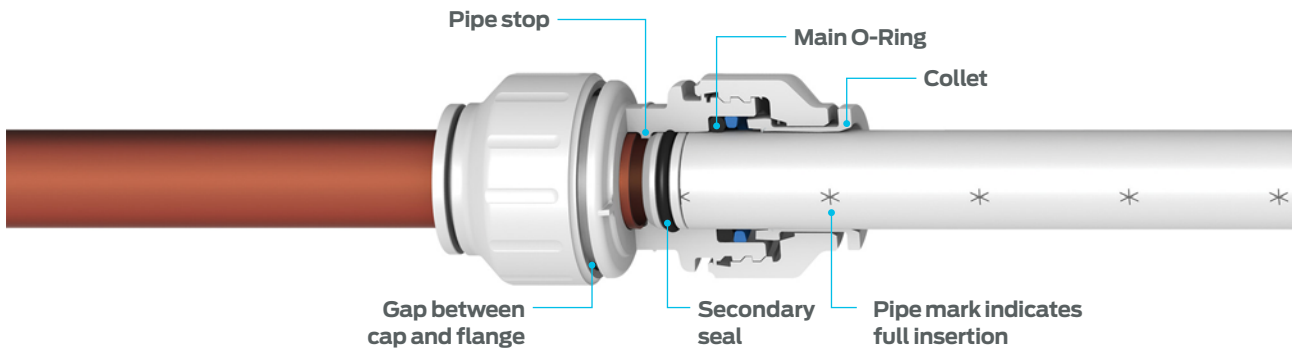

### Making A Good Connection

Fittings and pipe should be kept in their original packaging to ensure they are clean and undamaged before use.

#### Prepare the Pipe

Ensure the pipe is free of score marks. Cut the pipe square. We recommend the use of JG Pipe Cutters.

To prevent damage to the O-Ring, remove all burrs and sharp edges. When connecting Speedfit pipe, use a Speedfit Pipe Insert. A twisting motion will aid insertion. The insert should only be used with Speedfit pipe.

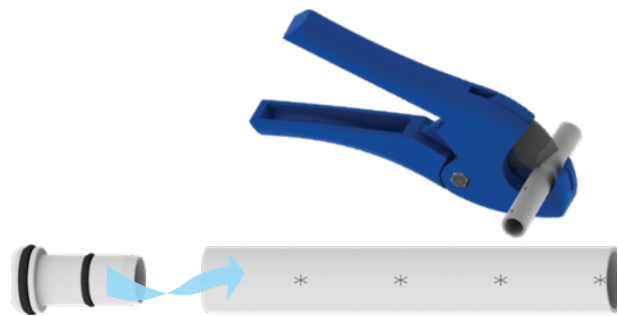

#### Push Up to Pipe Stop

The fitting should be in the 'unlocked' position. This is shown with a small gap between the screwcap and the body flange.

Push the pipe fully into the fitting, up to the pipe stop. A good connection has been made.

If you are not using collet clips, ensure that the screwcaps are in the locked position.



#### Added benefit of Speedfit Twist and Lock

Twist the screwcap until it touches the body flange. This increases the O-Ring seal around the pipe and locks the pipe into position.

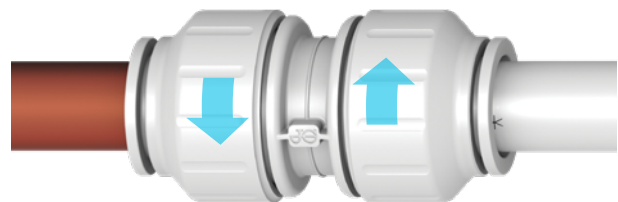

#### Pull to Check Secure.

It is good practice to test the system prior to leaving the site, or before use. Our recommended test procedure is shown in our Technical Checklist.



**To Disconnect**

Ensure that the system is depressurised.

The screwcap on Speedfit Twist and Lock fittings will need to be turned back to the unlocked position.

Push the collet square against the face of the fitting by using fingers, or with the help of our collet release tool.

With the collet held in position, the pipe can be removed. The fitting can be used again without the need for replacement parts.

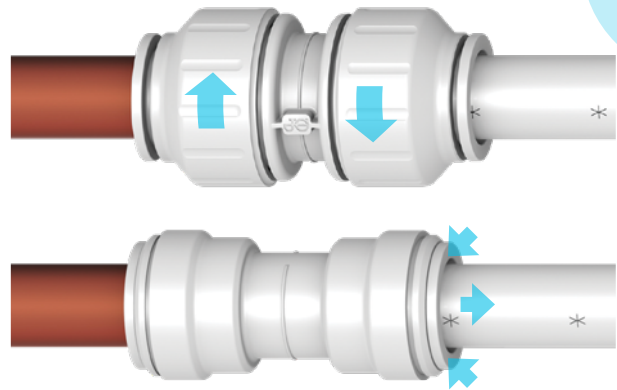

**Installation Troubleshooting**

Do not use a hacksaw to cut the pipe. This will leave unwanted burrs on the end of the pipe.

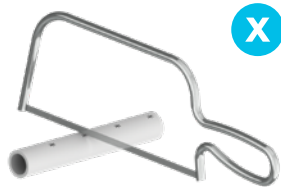

**Do not insert fingers into the fitting as the stainless steel teeth may cause injury.**

Do not use damaged or scored pipe. Score marks can cause leaks past the O-Ring.

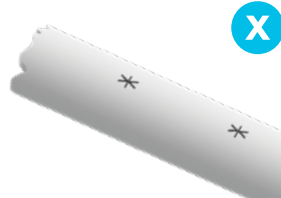

**Remember to pressure test the completed installation according to the recommendations in the Technical Specifications section.**

Make sure to push the pipe fully into the fitting, past both the collet (gripper) and the O-Ring.

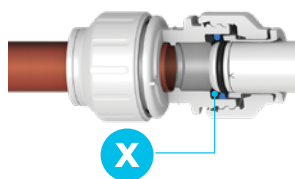

Fitting may be gripped but not sealed if pipe is not fully inserted.





Technical Information  
page 7

## Speedfit Twist and Lock Fittings

### WaterMarked Fittings

Speedfit Twist and Lock fittings have a unique grip-then-seal construction, made up of a collet with stainless steel teeth to grip the pipe, and an O-Ring to provide a permanent leak proof seal.

Temperature	Pressure	Temperature	Pressure
AIR/VACUUM	12mm	POTABLE LIQUIDS	12mm
Not Suitable		DO NOT FREEZE	
		+1°C	2000kpa
		+20°C	2000kpa
		+70°C*	1000kpa

\* NOT to exceed maximum temperature



### Equal Straight Connector

Order Code	Tube OD	Pack Size	List Price
PEM0412W	12mm	10	9.35



### Equal Elbow

Order Code	Tube OD	Pack Size	List Price
PEM0312W	12mm	10	10.04



### Stem Elbow

Order Code	Tube OD	Stem	Pack Size	List Price
PEM221212W	12mm	12mm	10	11.13

Provides a swivel type connection.



### Equal Tee

Order Code	Tube OD	Pack Size	List Price
PEM0212W	12mm	5	11.37



### Stem Tee

Order Code	Tube OD	Stem OD	Tube OD	Pack Size	List Price
PEM531212W	12mm	12mm	12mm	5	16.72



### Straight Tap Connector

Order Code	Tube OD	Thread BSP	Pack Size	List Price
PEMSTC1214	12mm	1/2"	5	9.05

With brass swivel nut and sealing washer. For torque figures see Technical Specification chapter.



## Bent Tap Connector

Order Code	Tube OD	Thread BSP	Pack Size	List Price
PEMBTC1214	12mm	1/2"	5	15.87



## Stop End

Order Code	Tube OD	Pack Size	List Price
PSE4612W	12mm	10	5.56

For a permanent or temporary shut off.



## Brass Male Coupler

Order Code	Tube OD	Thread BSP	Pack Size	List Price
NC2771	12mm	1/2"	10	16.70

Manufactured in DZR Brass.



## Brass Female Coupler

Order Code	Tube OD	Thread BSP	Pack Size	List Price
MW451213	12mm	3/8"	10	15.08

Manufactured in DZR Brass.



## Speedpex Barrier Pipe – Coil

Order Code	Tube OD	Length (m)	Pack Size	List Price
WM12BPEX-50C	12mm	50m	Coil	276.02



## Pipe Insert

Order Code	Tube OD	Pack Size	List Price
TSM12	12mm	50	0.84

To be used when connecting Speedfit pipe to a Speedfit fitting.

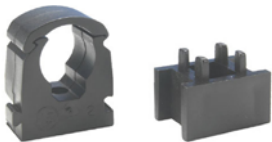

## Pipe Clips And Spacers

Order Code	Tube OD	Pack Size	List Price
PC12W	12mm	50	0.84
PCSW		1	0.52



**Collet Locking Clip**

Order Code	Colour	Tube OD	Pack Size	List Price
CM1812B	Blue	12mm	100	0.75
CM1812R	Red	12mm	100	0.75

Collet Clips prevent accidental release of pipe from non-Twist and Lock fittings ie. Stop Ends and brass fittings. Red and blue clips can also be used to provide colour coding of pipe on both Twist and Lock and non-Twist and Lock fittings.



**Pipe Cutter**

Order Code	Pack Size	List Price
JG-TS	1	73.73

For up to 22mm size pipe.





# Speedfit

Fittings, Valves and Tubing

## Speedfit Fittings Technical Specifications

### Materials of Construction

Speedfit fittings are made up of three components;

- Bodies are produced in an acetal copolymer or polypropylene.
- O-Rings are nitrile rubber or EPDM.
- Collets are produced in acetal copolymer or polypropylene with stainless steel teeth.

### Working Pressure and Temperature Range

Refer to appropriate product group section.

### Pipe Types

- LLDPE tube – polyethylene, nylon and polyurethane conforming to the tolerances shown below. For soft tubing or thin wall pipe, we recommend the use of tube inserts.
- Braided pipe – use of Tube to Hose Stems listed in this manual is essential when using braided pipe. Use of clamps to retain braided tube on barbs is recommended.
- Metal pipe (soft) – brass, copper or mild steel conforming to the tolerances below.
- Metal pipe (hard) – we do not recommend Speedfit fittings for hard metal or chromium plated pipes.

For stainless steel and other polished metal pipes, we recommend the use of Superseal fittings (refer to the Superseal Fittings – SM & SI Range chapter in this manual).

It is essential that outside diameters be free from score marks and that the pipe be deburred before inserting the fitting.

### Installation and System Testing

**Fittings and pipe should be kept clean and undamaged before use.** All pipe and fittings installations must be pressure tested after installation, to ensure system integrity before handing over to the final user. See also, the Speedfit Installation chapter for further details.

### 1/4 Turn Valves

These valves have been designed to allow temporary servicing of downstream equipment and must only be used in the fully open or fully closed position.

**Do not use these valves** in a partially open position to control flow; to provide a permanent termination; without pipe assembled or plugged (or threaded connections sealed, or as a tap or faucet).

### Chemicals

Before using Speedfit fittings and pipe with chemicals or other potentially aggressive liquids, please contact our Customer Service Department.

In general, use only water or oil based paint. **Do not allow contact with** Cellulose based paint, paint thinners or strippers, solder flux, or aggressive cleaners.

Keep away from ozone generators such as electric motors, mercury vapour lamps, and high voltage electrical equipment.

Speedfit fittings are not recommended for use with explosive gases, petroleum spirits, and other fuels, or for central heating systems.

### Collet Covers

Collet covers are available as additional security against removal of the pipe, or to provide a simple means of colour coding.

### Maximum Torque Values for Plastic Threads BSP, BSPT and NPT

Plastic threads are not generally as strong as brass threads. Customers and end users should be aware of this when choosing products for their applications. Over tightening of plastic threads will cause undue stress and eventual cracking and leakage. The maximum torque figures for BSP and BSPT threads used on John Guest fittings in mating threads conforming to the relevant BS or International thread standards are shown below.

	1/8" – 1/4"	Threads 3/8" – 1/2"	3/4"
Maximum Torque	1.5Nm	3.0Nm	4.0Nm

John Guest recommend OEM customers to consider replacing threaded ports with the more modern Cartridge Systems. It is also recommended that all installations are checked prior to use to determine that a seal has been made.

## Maintenance and Replacement Intervals

John Guest products generally require little maintenance, but as a minimum, we recommend routine visual inspection. Frequency of visual inspection will depend on severity of application and risk of failure. If after visual inspection John Guest products appear damaged, cracked, charred, discoloured, heat distorted or corroded they should be replaced. Any product that is or appears to be leaking should be replaced.

Product life is affected by the severity of the application, the hostility of the working environment and contact with aggressive chemicals or liquids. It is, therefore, important that specific replacement intervals be considered by specifiers/users/customers, based on previous service life, or when failure could result in unacceptable downtime, damage or injury risk.

## Cleaners and Sanitising of Fittings

The external surfaces of John Guest products must not come into contact with oxidising or acidic cleaners and sanitising agents, for example (but not limited to), those below pH 4, high in sodium hypochlorite level (bleach), or containing hydrogen peroxide. Our plastic material suppliers recommend ECOLAB Oasis 133 as a suitable cleaner for the external surfaces of products manufactured by John Guest.

Several different methods exist for sanitising the internal surfaces of fluid systems, including sodium hypochlorite, hydrogen peroxide, chlorine dioxide or ozone. It is entirely the responsibility of the end user to determine if the chosen method is suitable for use with John Guest products over the planned working life of the system. However, to avoid unnecessary early failure, John Guest requires that the disinfection solution must be immediately flushed out at all draw off points with fresh water at the end of the disinfection period. **The solution must not be left in the system.** Disinfection solutions must only come into contact with the internal (fluid carrying) surfaces of the system. If any other surfaces of a fitting comes into contact with disinfection solution, the whole fitting must be replaced immediately. Polypropylene fittings offer greater resistance to aggressive chemicals than Acetal fittings, but do not have the same mechanical properties. John Guest polypropylene fittings are generally designated by the part number prefix PP or PPM.

## Side Loads

John Guest products are not designed to be used whilst under side load as this may adversely affect their ability to function long-term. Always ensure tubes have good alignment with the fitting. They must also not be subjected to any form of impact or other damage, such as being hit or dropped, even accidentally. If fittings have been damaged or suffered an impact, they should be replaced immediately. RWC warranty does not cover loss caused by any form of damage.

## LLDPE Tube Technical Specifications

### Potable Water Applications

John Guest LLDPE tubing is suitable for potable cold water applications with a maximum chlorine content of 4 parts per million (4ppm). Heating water above 20°C and/or pressures above the maximum will significantly reduce service life. Direct exposure to sunlight will also significantly reduce its useful service. As part of good practice, tubing should be inspected regularly. If there is any evidence of damage, hardening or cracking, it should be replaced immediately.

### UV Resistance

Only black LLDPE tube should be installed in areas exposed to any light if biofilm growth is considered an issue. In this case, any other coloured tube must be protected from light exposure. Black LLDPE tube is also UV stabilised and can be installed where exposed to direct or indirect sunlight (UV).

### Chemical Resistance

For use of LLDPE tube with chemicals or potentially aggressive liquids, please refer to our Customer Service Department. When using cleaning agents or other potentially aggressive liquids, please ensure compatibility with tubing and fittings. LLDPE is not recommended for mineral oils, gases and fuels or high pressure compressed air/pneumatic systems.

### Pneumatics Applications

John Guest LLDPE tube is suitable for pneumatic applications providing pressure is maximum 1000kPa @ 20°C. At elevated temperatures (50°C+) mineral oil will degrade LLDPE tube and, therefore, LLDPE tube used in pneumatic circuits should be periodically checked and replaced if necessary.

### Tube Inserts

If the tube is used in a warm water system a tube insert is necessary.

**LLDPE Tube Tolerances**

Tube OD	Tolerance
1/4" to 1/2"	+0.001/-0.004"
4mm	+0.05/-0.07mm
6mm to 12mm	+0.05/-0.10mm
15mm	+0.10/-0.10mm

**Minimum Bend Radii**

Tube OD	Tube ID	Minimum Bend Radius
1/4"	0.170"	1.00"
5/16"	0.187"	1.13"
3/8"	0.250"	1.25"
1/2"	0.375"	2.50"
4mm	2.5mm	25mm
6mm	4mm	25mm
8mm	6mm	30mm
10mm	7mm	32mm
12mm	9mm	63mm
15mm	11.5mm	100mm

## How To Make A Connection – Speedfit Range

To make a connection, the tube is simply pushed in by hand; the unique patented John Guest collet locking system then holds the tube firmly in place without deforming it or restricting flow. The Collet (gripper) has stainless steel teeth which hold the pipe firmly in position, while the O-Ring provides a permanent leakproof seal.

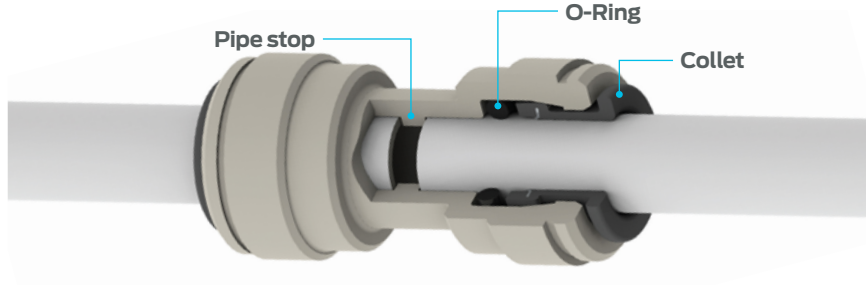

### Making A Good Connection

Fittings and pipe should be kept in their original packaging to ensure they are clean and undamaged before use.

#### Prepare the pipe

Ensure the pipe is free of score marks. Cut the pipe square. We recommend the use of JG Pipe Cutters.

To prevent damage to the O-Ring, remove all burrs and sharp edges. When connecting Speedfit Pipe, use a Speedfit Pipe Insert. A twisting motion will aid insertion. The insert should only be used with Speedfit Pipe.



#### Push Up To Pipe Stop

Push the pipe into the fitting, to the pipe stop.

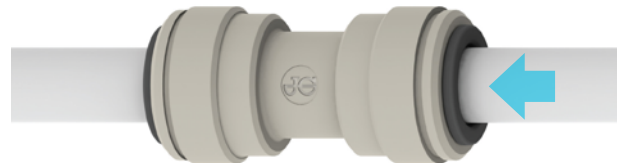

#### Pull To Check Secure

Pull on the pipe to check it is secure. Test the system before use.



Don't forget to push the pipe fully into the fitting, past both the collet (gripper) and the O-Ring.

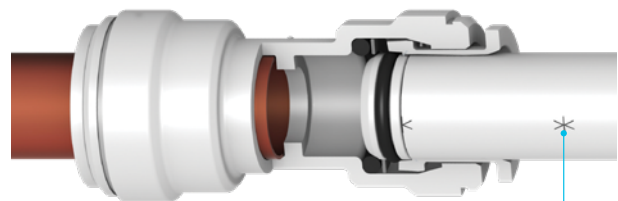

Pipe mark not level with collet head – indicating pipe not pushed fully home

### To Disconnect

Push in collet and remove tube.

To disconnect, ensure the system is depressurized, push the collet square against the fitting. With the collet held in this position the tube can be removed.





### Pipe Stop Distances

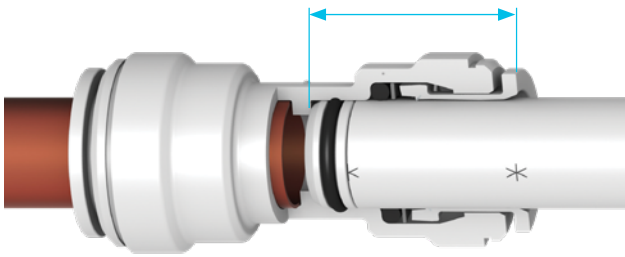

Stops are located at the following distances from the end of the fitting:

Size	Stop distance
10mm	20mm
15mm	30mm
22mm	35mm
28mm	44mm

### Collet Covers and Collet Clips

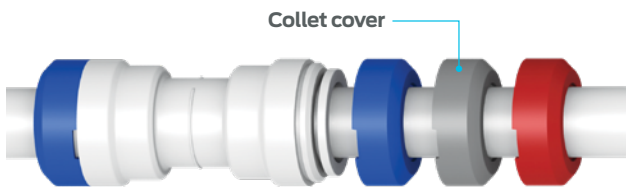

Use a collet cover or collet clip to provide added security against pipe disconnection, e.g. the fitting coming into contact with rigid surfaces and behind dry-lining walls.

Collet covers for use with standard Speedfit fittings, are available in white, red or blue to allow colour coding of pipes.

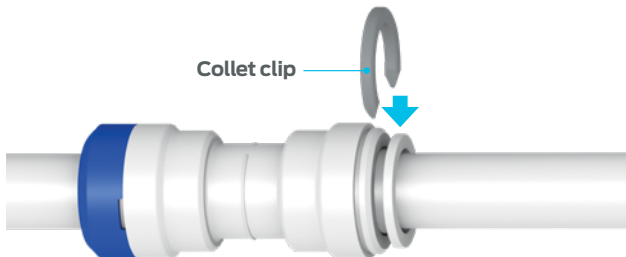

White or grey collet clips are used with standard fittings to prevent accidental pipe disconnection.

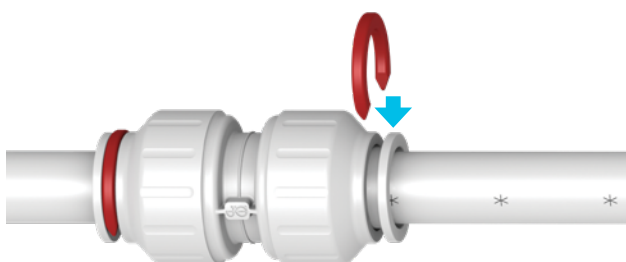

Red or blue collet clips provide colour coding of pipe on Twist & Lock fittings. They are not designed to prevent accidental release, and should be fitted when the fitting is in the locked position.

### Typical Bar Installation

John Guest Speedfit push-to-connect fittings have been designed for a wide range of industrial applications. They provide a fast and secure way of connecting tubes, and offer considerable advantages over conventional fittings.

Complex pipe systems can be assembled more rapidly than with traditional methods, and because Speedfit fittings are easy to disconnect, fault finding and maintenance become a much easier operation.

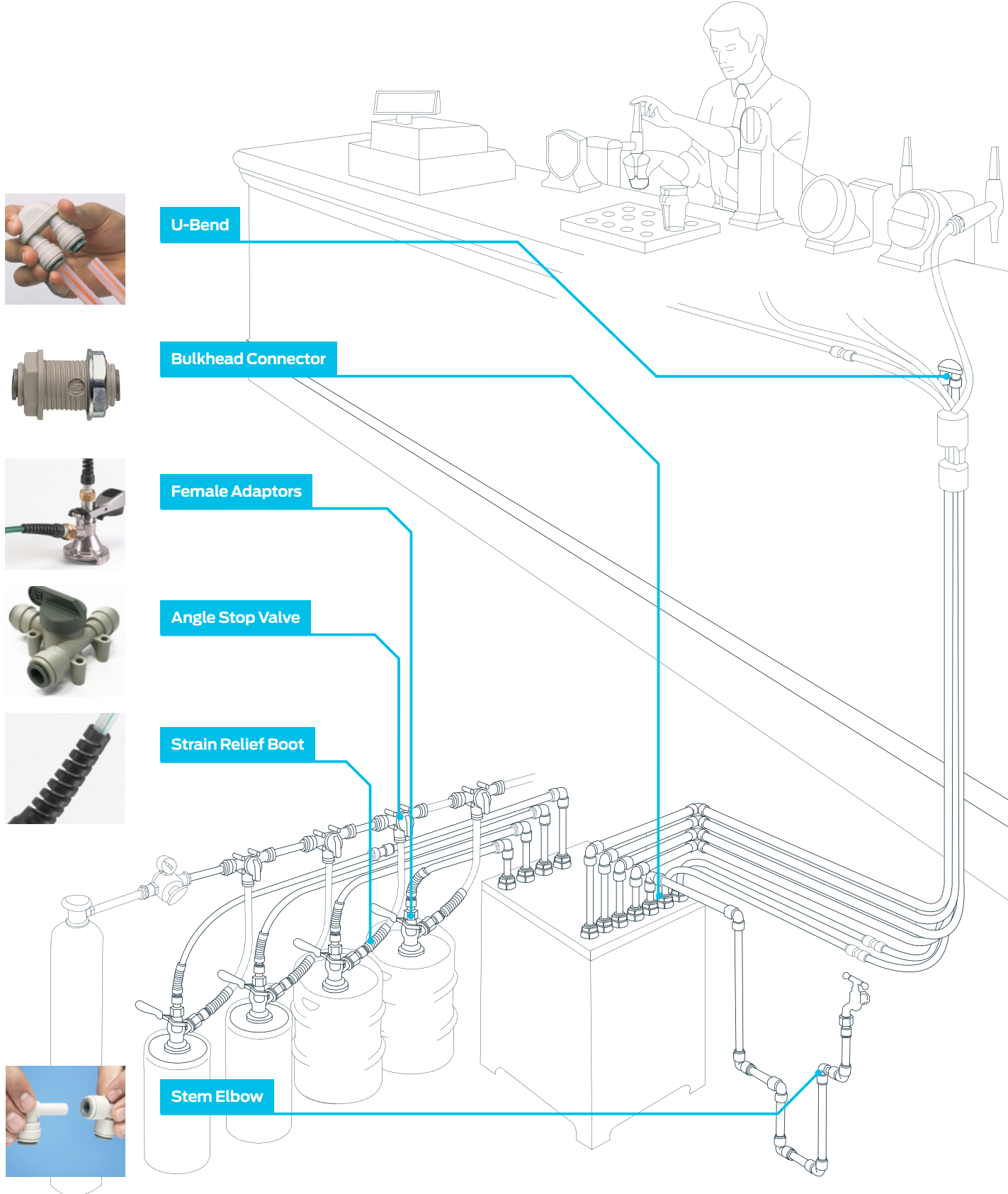

Standard JG Speedfit products can be coupled together to form integral new fittings:

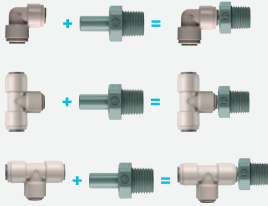

## Grey Acetal Fittings – PI Range

### For liquids and inert gases

PI fittings offered in sizes 5/32" to 5/8" are manufactured in grey acetal copolymer, and fitted with a food grade Nitrile O-Ring, making them especially suitable for applications involving foodstuffs and potable liquids. They are however equally suitable for air and inert gases, and can be used on N<sub>2</sub>/CO<sub>2</sub> mixed gas dispense lines, pneumatic and vacuum applications. Ensure products are installed in accordance with local codes of practice.

Temperature			Pressure		
AIR/VACUUM	5/32" - 5/16"	3/8" - 5/8"	POTABLE LIQUIDS	5/32" - 5/16"	3/8" - 5/8"
-20°C	1600kPa	1000kPa	DO NOT FREEZE		
+1°C	1600kPa	1000kPa	+1°C	1600kPa	1000kPa
+20°C	1600kPa	1000kPa	+20°C	1600kPa	1000kPa
+65°C*	1600kPa	700kPa	+65°C*	1600kPa	700kPa

\* NOT to exceed maximum temperature



Technical Information  
page 15



Accessories  
page 61



Imperial to Metric  
Adaptors  
page 52



### Straight Adaptor – BSPT Thread

Order Code	Tube OD	Thread BSPT	Pack Size	List Price
PI010601S	3/16"	1/8"	10	2.67
PI010602S	3/16"	1/4"	10	2.67
PI010801S	1/4"	1/8"	10	2.90
PM010801S	5/16"	1/8"	10	3.41
PM010802S	5/16"	1/4"	10	3.59
PM010803S	5/16"	3/8"	10	4.44
PI011202S	3/8"	1/4"	10	5.35
PI011203S	3/8"	3/8"	10	5.72
PI011603S	1/2"	3/8"	10	7.60
PI011604S	1/2"	1/2"	10	8.41



### Straight Adaptor – BSP Thread

Order Code	Tube OD	Thread BSP	Pack Size	List Price
PI010812S	1/4"	1/4"	10	4.09
PI011212S	3/8"	1/4"	10	5.72
PI011213S	3/8"	3/8"	10	4.64

For use with spot face ports.

**Straight Adaptor – NPTF Thread**

Order Code	Tube OD	Thread NPTF	Pack Size	List Price
PI010821S	1/4"	1/8"	10	2.92
PI010822S	1/4"	1/4"	10	3.33
PI010823S	1/4"	3/8"	10	3.17
PM010821S	5/16"	1/8"	10	3.41
PM010822S	5/16"	1/4"	10	3.58
PM010823S	5/16"	3/8"	10	4.44
PI011221S	3/8"	1/8"	10	5.29
PI011222S	3/8"	1/4"	10	5.35
PI011223S	3/8"	3/8"	10	5.72
PI011224S	3/8"	1/2"	10	7.60
PI011623S	1/2"	3/8"	10	7.60
PI011624S	1/2"	1/2"	10	8.41

**Straight Adaptor – British Nipple Type**

Order Code	Tube OD	Thread BSW	Pack Size	List Price
PM0108E5S	5/16"	1/2" - 24	10	3.56
PI0112E5S	3/8"	1/2" - 24	10	5.17

**Straight Adaptor – MFL Thread**

Order Code	Tube OD	Thread MFL	Pack Size	List Price
PI0112F6S	3/8"	3/8"	10	5.43

**Equal Straight Connector**

Order Code	Tube OD	Pack Size	List Price
PM0404S	5/32"	10	3.71
PI0406S	3/16"	10	3.77
PI0408S	1/4"	10	4.26
PM0408S	5/16"	10	4.45
PI0412S	3/8"	10	5.77
PI0416S	1/2"	10	7.05

**Reducing Straight Connector**

Order Code	Tube OD	Tube OD	Pack Size	List Price
PI200806S	1/4"	3/16"	10	4.55
PM200804S	5/16"	5/32"	10	4.63
PI201008S	5/16"	1/4"	10	4.73
PI201206S	3/8"	3/16"	10	5.65
PI201208S	3/8"	1/4"	10	5.71
PI201210S	3/8"	5/16"	10	5.12
PI201608S	1/2"	1/4"	10	4.74
PI201610S	1/2"	5/16"	10	6.69
PI201612S	1/2"	3/8"	10	7.20

**Equal Elbow**

Order Code	Tube OD	Pack Size	List Price
PI0306S	3/16"	10	4.44
PI0308S	1/4"	10	5.25
PM0308S	5/16"	10	5.40
PI0312S	3/8"	10	7.54
PI0316S	1/2"	10	9.09

**Reducing Elbow**

Order Code	Tube OD	Tube OD	Pack Size	List Price
PI211008S	5/16"	1/4"	10	5.77
PI211206S	3/8"	3/16"	10	8.03
PI211208S	3/8"	1/4"	10	8.08
PI211210S	3/8"	5/16"	10	8.15
PI211610S	1/2"	5/16"	10	8.37
PI211612S	1/2"	3/8"	10	9.28

**Stem Elbow**

Order Code	Stem OD	Tube OD	Pack Size	List Price
PI220606S	3/16"	3/16"	10	4.44
PI220808S	1/4"	1/4"	10	4.50
PM220808S	5/16"	5/16"	10	5.54
PI221208S	3/8"	1/4"	10	7.91
PI221210S	3/8"	5/16"	10	6.15
PI221212S	3/8"	3/8"	10	8.19
PI221616S	1/2"	1/2"	10	8.76



**Rigid Elbow – NPTF Thread**

Order Code	Tube OD	Thread NPTF	Pack Size	List Price
PI480821S	1/4"	1/8"	10	3.81
PI480822S	1/4"	1/4"	10	4.29
PI480823S	1/4"	3/8"	10	6.86
PI481222S	3/8"	1/4"	10	7.29
PI481223S	3/8"	3/8"	10	7.73

**Equal Tee**

Order Code	Tube OD	Pack Size	List Price
PI0206S	3/16"	10	5.96
PI0208S	1/4"	10	6.65
PM0208S	5/16"	10	6.82
PI0212S	3/8"	10	7.97
PI0216S	1/2"	10	9.66

**Reducing Tee**

Order Code	Tube OD	Tube OD Branch	Pack Size	List Price
PI301208S	3/8"	1/4"	10	7.74
PI301612S	1/2"	3/8"	10	10.70

**Swivel Elbow – BSPT Thread**

Order Code	Tube OD	Thread BSPT	Pack Size	List Price
PI090601S	3/16"	1/8"	10	7.41
PI090801S	1/4"	1/8"	10	8.42
PI090802S	1/4"	1/4"	10	8.60
PM090802S	5/16"	1/4"	10	8.88
PM090803S	5/16"	3/8"	10	9.22
PI091202S	3/8"	1/4"	10	11.17
PI091603S	1/2"	3/8"	10	13.65
PI091604S	1/2"	1/2"	10	13.80

**Swivel Elbow – NPTF Thread**

Order Code	Tube OD	Thread NPTF	Pack Size	List Price
PM090421S	5/32"	1/8"	10	6.26
PI090821S	1/4"	1/8"	10	8.41
PI090822S	1/4"	1/4"	10	8.60
PM090822S	5/16"	1/4"	10	8.87
PI091222S	3/8"	1/4"	10	11.18
PI091223S	3/8"	3/8"	10	12.03
PI091623S	1/2"	3/8"	10	13.65
PI091624S	1/2"	1/2"	10	13.80

**Swivel Branch Tee – BSPT Thread**

Order Code	Tube OD	Thread BSPT	Pack Size	List Price
PI100801S	1/4"	1/8"	10	9.90
PI100802S	1/4"	1/4"	10	10.03
PM100801S	5/16"	1/8"	10	10.32
PI101202S	3/8"	1/4"	10	11.61
PI101203S	3/8"	3/8"	10	12.46
PI101604S	1/2"	1/2"	10	14.42

**Swivel Branch Tee – NPTF Thread**

Order Code	Tube OD	Thread NPTF	Pack Size	List Price
PI100821S	1/4"	1/8"	10	9.90
PI100822S	1/4"	1/4"	10	10.04
PI101222S	3/8"	1/4"	10	11.61
PI101624S	1/2"	1/2"	10	14.42

**Swivel Male Run Tee – BSPT Thread**

Order Code	Tube OD	Thread BSPT	Pack Size	List Price
PI110802S	1/4"	1/4"	10	10.04

**Swivel Male Run Tee – NPTF Thread**

Order Code	Tube OD	Thread NPTF	Pack Size	List Price
PI110822S	1/4"	1/4"	10	10.04

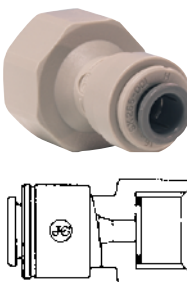
**Female Adaptor – Flat End BSP Thread**

Order Code	Tube OD	Thread BSP	Pack Size	List Price
PI451014FS	5/16"	1/2"	10	8.47
PI451015FS	5/16"	5/8"	10	8.99
PI451213S	3/8"	3/8"	10	8.71
PI451214FS	3/8"	1/2"	10	8.87
PI451215FS	3/8"	5/8"	10	9.55
PI451613S	1/2"	3/8"	10	9.84
PI451615FS	1/2"	5/8"	10	9.84

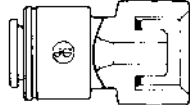
**Female Adaptor – Cone End BSP Thread**

Order Code	Tube OD	Thread BSP	Pack Size	List Price
PI451014CS	5/16"	1/2"	10	9.09
PI451015CS	5/16"	5/8"	10	9.09
PI451214CS	3/8"	1/2"	10	8.99
PI451215CS	3/8"	5/8"	10	9.09
PI451614CS	1/2"	1/2"	10	10.64

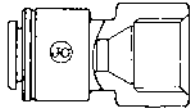
**Female Adaptor – UNS Thread**

Order Code	Tube OD	Thread UNS	Pack Size	List Price
PI4512C5S	3/8"	1/2" - 16	10	8.88

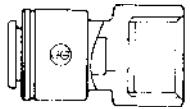

**Female Adaptor – NPTF Thread**

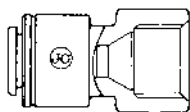
Order Code	Tube OD	Thread NPTF	Pack Size	List Price
PI450822S	1/4"	1/4"	10	5.53
PI451222S	3/8"	1/4"	10	5.53

**Female Adaptor – FFL Thread**

Order Code	Tube OD	Thread FFL	Pack Size	List Price
PM4508F4S	5/16"	1/4"	10	5.25
PI4512F4S	3/8"	1/4"	10	6.02
PI4512F6S	3/8"	3/8"	10	7.02

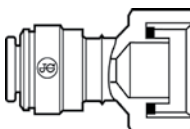
1/4 (FFL) corresponds to a 7/16 UNF. 3/8 (FFL) corresponds to a 5/8 UNF.

**Tap Adaptor – BSP Thread**

Order Code	Tube OD	Thread BSP	Pack Size	List Price
CI320814S	1/4"	1/2"	10	5.11
CI320816S	1/4"	3/4"	10	6.02
CI321214S	3/8"	1/2"	10	5.37
CI321216S	3/8"	3/4"	10	6.85

Not suitable for air/vacuum applications.

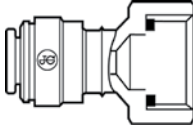

### Tap Adaptor – Flat End BSP Thread

Order Code	Tube OD	Thread BSP	Pack Size	List Price
CI320816FS	1/4"	3/4"	10	5.61
CI321216FS	3/8"	3/4"	10	5.27

Not suitable for air/vacuum applications.

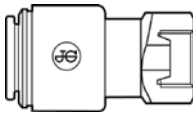

### Tap Adaptor – UNS Thread

Order Code	Tube OD	Thread UNS	Pack Size	List Price
CI3208U7S	1/4"	7/16" - 24	10	4.55
CI3210U7S	5/16"	7/16" - 24	10	5.37
CI3212U7S	3/8"	7/16" - 24	10	5.37

Not suitable for air/vacuum applications.

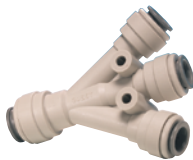

### Three-Way Divider

Order Code	Tube OD Inlet	Tube OD Outlet	Pack Size	List Price
PI491612S	1/2"	3/8"	10	14.38



### Three-Way Divider – Red

Order Code	Tube OD Inlet	Tube OD Outlet	Pack Size	List Price
PI491212S-R	3/8"	3/8"	5	16.46



### Two-Way Divider

Order Code	Tube OD	Pack Size	List Price
PI2308S	1/4"	10	6.95
PM2308S	5/16"	10	7.20
PI2312S	3/8"	10	8.46
PI2316S	1/2"	5	11.20



### Unequal Two-Way Divider

Order Code	Tube OD	Thread NPTF	Pack Size	List Price
PI241210S	3/8"	5/16"	10	7.97

**Bulkhead Connector**

Order Code	Tube OD	Pack Size	List Price
PI1206S	3/16"	10	6.53
PI1208S	1/4"	10	6.64
PM1208S	5/16"	10	9.71
PI1212S	3/8"	10	9.89
PI1216S	1/2"	5	17.22

**Reducing Bulkhead Connector**

Order Code	Tube OD	Tube OD	Pack Size	List Price
PI121208S	3/8"	1/4"	10	9.89
NC2429	1/4"	6mm	10	7.80

**Stem Adaptor – BSPT Thread**

Order Code	Stem OD	Thread BSPT	Pack Size	List Price
PI050801S	1/4"	1/8"	10	2.86
PI050802S	1/4"	1/4"	10	2.99
PM050801S	5/16"	1/8"	10	3.06
PM050802S	5/16"	1/4"	10	3.11
PM050803S	5/16"	3/8"	10	3.41
PI051202S	3/8"	1/4"	10	3.14
PI051203S	3/8"	3/8"	10	3.95
PI051603S	1/2"	3/8"	10	4.01
PI051604S	1/2"	1/2"	10	4.08

**Stem Adaptor – BSP Thread**

Order Code	Stem OD	Thread BSP	Pack Size	List Price
PI051212S	3/8"	1/4"	10	2.86
PI051213S	3/8"	3/8"	10	2.95

**Stem Adaptor – NPTF Thread**

Order Code	Stem OD	Thread NPTF	Pack Size	List Price
PI050821S	1/4"	1/8"	10	2.86
PI050822S	1/4"	1/4"	10	2.99
PI050823S	1/4"	3/8"	10	3.50
PM050822S	5/16"	1/4"	10	3.11
PI051222S	3/8"	1/4"	10	3.17
PI051223S	3/8"	3/8"	10	3.95
PI051623S	1/2"	3/8"	10	4.01
PI051624S	1/2"	1/2"	10	4.07

**Stem Adaptor – British Nipple Type**

Order Code	Stem OD	Thread BSW	Pack Size	List Price
PI0512E5S	3/8"	1/2" - 24	10	3.20

**Tube to Hose Stem**

Order Code	Stem OD	Hose ID	Pack Size	List Price
PI250806S	1/4"	3/16"	10	2.31
PI250808S	1/4"	1/4"	10	2.50
PI250810S	1/4"	5/16"	10	2.37
PI251006S	5/16"	3/16"	10	2.54
PI251008S	5/16"	1/4"	10	2.73
PM250808S	5/16"	5/16"	10	2.90
PI251012S	5/16"	3/8"	10	4.01
PI251208S	3/8"	1/4"	10	4.07
PI251210S	3/8"	5/16"	10	3.82
PI251212S	3/8"	3/8"	10	4.14
PI251216S	3/8"	1/2"	10	4.45
PI251612S	1/2"	3/8"	10	4.87
PI251616S	1/2"	1/2"	10	5.35

**Tube to Hose Stem – Long Version**

Order Code	Stem OD	Hose ID	Pack Size	List Price
PI251012SL	5/16"	3/8"	10	4.07
PI251212SL	3/8"	3/8"	10	4.14

**Tube to Hose Elbow**

Order Code	Stem OD	Hose ID	Pack Size	List Price
PI290808S	1/4"	1/4"	10	3.58
PI290810S	1/4"	5/16"	10	3.77
PI291008S	5/16"	1/4"	10	3.58
PM290808S	5/16"	5/16"	10	3.77
PI291208S	3/8"	1/4"	10	4.50
PI291210S	3/8"	5/16"	10	4.63

**Enlarger**

Order Code	Tube OD	Stem OD	Pack Size	List Price
PI131012S	3/8"	5/16"	10	4.32
PI131216S	1/2"	3/8"	10	7.94



**Reducer**

Order Code	Stem OD	Tube OD	Pack Size	List Price
PI060605S	3/16"	5/32"	10	2.67
PI061006S	5/16"	3/16"	10	3.17
PI061008S	5/16"	1/4"	10	3.35
PI061206S	3/8"	3/16"	10	3.82
PI061208S	3/8"	1/4"	10	4.05
PI061210S	3/8"	5/16"	10	4.14
PI061610S	1/2"	5/16"	10	4.50
PI061612S	1/2"	3/8"	10	7.29

**Cross**

Order Code	Tube OD	Pack Size	List Price
PI4712S	3/8"	10	15.44

**U-Bend**

Order Code	Tube OD	Pack Size	List Price
PIUB12S	3/8"	10	9.20
PIUB16S	1/2"	10	9.20

**Plug**

Order Code	Stem OD	Pack Size	List Price
PI0808S	1/4"	10	1.14
PM0808S	5/16"	10	1.44
PI0812S	3/8"	10	2.00
PI0816S	1/2"	10	2.99

**End Stop**

Order Code	Stem OD	Pack Size	List Price
PI4608S	1/4"	10	2.19
PI4612S	3/8"	10	2.54



**Strain Relief Boot**

Order Code	Size	Pack Size	List Price
NC2447	3/8"	10	10.97
NC2448	1/2"	10	11.56

To suit most 3/8" or 1/2" fittings. The Strain Relief Boot has been developed to reduce the potential strain on the tubing. The Boot limits the bend radius of the tube, preventing it from kinking.



**Cooling Manifold**

Order Code	Tube Size Ends	Tube Size Branches	Pack Size	List Price
NC2183	15mm	3/8"	1	24.40

Intended for use on a 15mm Water Recirculation System.

A 4mm restriction between the two 15mm ports directs a proportion of recirculation water around a 3/8" looped spur.

Performance characteristics are dependent on a number of variables, so it is recommended that suitability is assessed against the customer's own criteria.

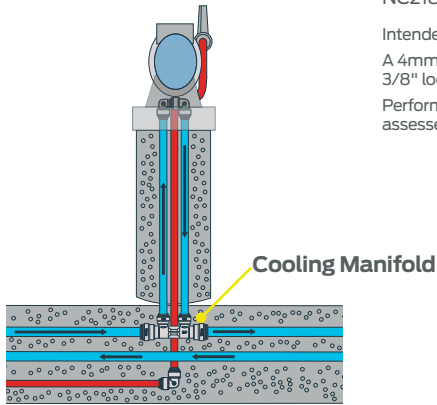

Standard JG Speedfit products can be coupled together to form integral new fittings:

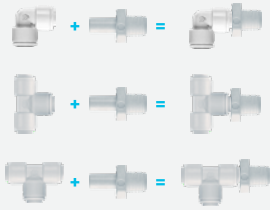

## White Acetal Fittings – CI Range

### For pure water and potable liquids

The CI range of imperial size fittings are manufactured in white acetal. With a food grade EPDM O-Ring, they have been developed for the water industry, but are equally suitable for other potable liquids.

Selected items are available with red or blue collets.

The CI Range is NOT suitable for compressed air and vacuum applications. For these situations we recommend the Grey Acetal Fittings – PI Range.

Temperature	Pressure	Temperature	Pressure
AIR/VACUUM	1/4" - 3/8"	POTABLE LIQUIDS	1/4" - 3/8"
Not Suitable		DO NOT FREEZE	
		+1°C	1000kPa
		+20°C	1000kPa
		+65°C*	700kPa

\*NOT to exceed maximum temperature



Technical Information  
page 15



Accessories  
page 61



Imperial to Metric  
Adaptors  
page 52



### Equal Straight Connector

Order Code	Tube OD	Pack Size	List Price
CI0408W	1/4"	10	4.26
CI0412W	3/8"	10	5.77



### Straight Adaptor – NPTF Thread

Order Code	Tube OD	Thread NPTF	Pack Size	List Price
CI010821W	1/4"	1/8"	10	2.90
CI010822W	1/4"	1/4"	10	3.33
CI010823W	1/4"	3/8"	10	3.54
CI011222W	3/8"	1/4"	10	5.35



### Equal Elbow

Order Code	Tube OD	Pack Size	List Price
CI0308W	1/4"	10	5.25
CI0312W	3/8"	10	7.54

**Stem Elbow**

Order Code	Stem OD	Tube OD	Pack Size	List Price
CI220808W	1/4"	1/4"	10	4.50
CI221208W	3/8"	1/4"	10	7.91
CI221212W	3/8"	3/8"	10	8.19

**Rigid Elbow – NPTF Thread**

Order Code	Tube OD	Thread NPTF	Pack Size	List Price
CI480821W	1/4"	1/8"	10	3.81
CI480822W	1/4"	1/4"	10	4.29
CI480823W	1/4"	3/8"	10	6.86
CI481222W	3/8"	1/4"	10	7.29

**Equal Tee**

Order Code	Tube OD	Pack Size	List Price
CI0208W	1/4"	10	6.65
CI0212W	3/8"	10	7.97

**Stem Tee (Run)**

Order Code	Tube OD	Stem OD	Tube OD	Pack Size	List Price
CI530808W	1/4"	1/4"	1/4"	10	4.06

**Bulkhead Connector**

Order Code	Tube OD	Pack Size	List Price
CI1208W	1/4"	10	7.10

**Female Connector – BSP Thread**

Order Code	Tube OD	Thread BSP	Pack Size	List Price
CI450814FW	1/4"	1/2"	10	5.11

**Stem Adaptor – NPTF Thread**

Order Code	Stem OD	Thread NPTF	Pack Size	List Price
CI050821W	1/4"	1/8"	10	2.86
CI050822W	1/4"	1/4"	10	2.99
CI051222W	3/8"	1/4"	10	3.01
CI051223W	3/8"	3/8"	10	3.17

**Reducer**

Order Code	Stem OD	Tube OD	Pack Size	List Price
CI061208W	3/8"	1/4"	10	4.07

**Barb Connector – Superseal x Barb**

Order Code	Superseal OD	Tube ID	Pack Size	List Price
CI270808W	1/4"	1/4"	10	4.73



Technical Information  
page 15



Accessories  
page 61



Imperial to Metric  
Adaptors  
page 52

## Polypropylene Fittings – PP Range

### For pure water and a wide range of applications

The PP Range of imperial size push-to-connect fittings are produced in white polypropylene and fitted with EPDM seals.

Polypropylene has the advantage of being more chemically resistant than acetal.

Temperature	Pressure	Temperature	Pressure
AIR/VACUUM	1/4" - 1/2"	POTABLE LIQUIDS	1/4" - 1/2"
		DO NOT FREEZE	
		+1°C	1000kPa
		+20°C	1000kPa
		+60°C*	400kPa

\*NOT to exceed maximum temperature



### Straight Adaptor – NPTF Thread

Order Code	Tube OD	Thread NPTF	Pack Size	List Price
PP010821W	1/4"	1/8"	10	2.98
PP010822W	1/4"	1/4"	10	3.48
PP010823W	1/4"	3/8"	10	3.48
PP010824W	1/4"	1/2"	10	2.78
PP011222W	3/8"	1/4"	10	5.56
PP011223W	3/8"	3/8"	10	5.56
PP011224W	3/8"	1/2"	10	8.26
PP011623W	1/2"	3/8"	10	8.26
PP011624W	1/2"	1/2"	10	9.15



### Equal Straight Connector

Order Code	Tube OD	Pack Size	List Price
PP0408W	1/4"	10	4.63
PPM0408W	5/16"	10	4.85
PP0412W	3/8"	10	6.28
PP0416W	1/2"	10	7.60



### Reducing Straight Connector

Order Code	Tube OD	Tube OD	Pack Size	List Price
PP201208W	3/8"	1/4"	10	5.71
PP201612W	1/2"	3/8"	10	7.76



**Equal Tee**

Order Code	Tube OD	Pack Size	List Price
PP0208W	1/4"	10	7.21
PPM0208W	5/16"	10	7.32
PP0212W	3/8"	10	8.69
PP0216W	1/2"	10	10.46

**Reducing Tee**

Order Code	Tube OD End	Tube OD End	Tube OD Branch	Pack Size	List Price
PP30120812W	3/8"	1/4"	3/8"	10	8.35
PP30121208W	3/8"	3/8"	1/4"	10	9.48
PP301612W	1/2"	1/2"	3/8"	10	11.61

**Equal Elbow**

Order Code	Tube OD	Pack Size	List Price
PP0308W	1/4"	10	5.45
PPM0308W	5/16"	10	5.66
PP0312W	3/8"	10	8.09
PP0316W	1/2"	10	9.79

**Reducing Elbow**

Order Code	Tube OD	Tube OD	Pack Size	List Price
PP211008W	5/16"	1/4"	10	5.06
PP211208W	3/8"	1/4"	10	6.52
PP211612W	1/2"	3/8"	10	7.07

**Stem Elbow**

Order Code	Stem OD	Tube OD	Pack Size	List Price
PP220808W	1/4"	1/4"	10	4.90
PPM220808W	5/16"	5/16"	10	5.84
PP221208W	3/8"	1/4"	10	8.22
PP221212W	3/8"	3/8"	10	8.86
PP221616W	1/2"	1/2"	10	9.48

**Rigid Elbow – NPTF Thread**

Order Code	Tube OD	Thread NPTF	Pack Size	List Price
PP480821W	1/4"	1/8"	10	3.69
PP480822W	1/4"	1/4"	10	4.52
PP480823W	1/4"	3/8"	10	7.55
PP481222W	3/8"	1/4"	10	7.55
PP481223W	3/8"	3/8"	10	7.76

**Bulkhead Connector**

Order Code	Tube OD	Pack Size	List Price
PP1208W	1/4"	10	8.43
PP1212W	3/8"	10	12.73
PP1216W	1/2"	5	15.09

**Female Adaptor – NPTF Thread**

Order Code	Tube OD	Thread NPTF	Pack Size	List Price
PP450822W	1/4"	1/4"	10	7.16

**Tap Adaptor – UNS Thread**

Order Code	Tube OD	Thread UNS	Pack Size	List Price
PP3208U7W	1/4"	7/16" - 24	10	6.06
PP3212U7W	3/8"	7/16" - 24	10	6.33

**Stem Adaptor – NPTF Thread**

Order Code	Stem OD	Thread NPTF	Pack Size	List Price
PP050822W	1/4"	1/4"	10	1.82
PP051222W	3/8"	1/4"	10	3.03
PP051223W	3/8"	3/8"	10	3.37
PP051624W	1/2"	1/2"	10	4.56

**Reducer**

Order Code	Stem OD	Tube OD	Pack Size	List Price
PP061208W	3/8"	1/4"	10	4.25
PP061612W	1/2"	3/8"	10	7.98



**Plug**

Order Code	Stem OD	Pack Size	List Price
PP0808W	1/4"	10	1.21
PPM0808W	5/16"	10	1.38
PP0812W	3/8"	10	1.98



**Tube to Hose Stem**

Order Code	Stem OD	Hose ID	Pack Size	List Price
PP251212W	3/8"	3/8"	10	4.63
PP251616W	1/2"	1/2"	10	6.05



**Unequal Divider**

Order Code	Tube OD	Tube OD	Pack Size	List Price
PP241208W	1/4"	3/8"	10	5.15



**Divider**

Order Code	Tube OD	Pack Size	List Price
PP2312W	3/8"	10	7.55

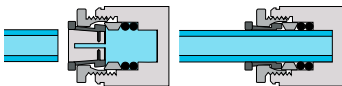
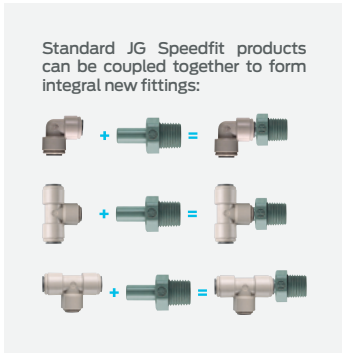

## Superseal Fittings – SM & SI Range

### For use with stainless steel tube

Superseal is a special fitting designed to provide extra grip on hard steel, stainless steel and other polished metal pipe.

The Superseal design features a collet with integrally moulded stainless steel teeth, similar to the standard Speedfit design, but incorporating an additional hand-operated nut and wedge shaped plastic washer to apply extra pressure to the collet, and the double O-Ring seals. This ensures that the collet teeth bite thoroughly into the tube to provide grip while at the same time, compressing the O-Rings to further enhance sealing.

Like other John Guest fittings, Superseal fittings are suitable for potable liquids and other food quality applications.

Temperature			Pressure			Temperature			Pressure								
AIR/VACUUM			1/4" & 5/16"			3/8"			POTABLE LIQUIDS			1/4" & 5/16"			3/8"		
-20°C			1600kPa			1000kPa			DO NOT FREEZE								
+1°C			1600kPa			1000kPa			+1°C			1600kPa			1000kPa		
+20°C			1600kPa			1000kPa			+20°C			1600kPa			1000kPa		
+65°C*			1000kPa			700kPa			+65°C*			1000kPa			700kPa		

\*NOT to exceed maximum temperature



Technical Information  
page 15



Accessories  
page 61



Imperial to Metric  
Adaptors  
page 52



### Straight Adaptor – BSPT Thread

Order Code	Superseal OD	Thread BSPT	Pack Size	List Price
SM010802S	5/16"	1/4"	10	6.69



### Straight Adaptor – BSP Thread

Order Code	Superseal OD	Thread BSP	Pack Size	List Price
SM010812S	5/16"	1/4"	10	9.77



### Straight Connector – Superseal x Superseal

Order Code	Superseal OD	Pack Size	List Price
SM410808E	5/16"	10	8.05

**Straight Connector – Superseal x Speedfit**

Order Code	Superseal OD	Speedfit OD	Pack Size	List Price
SM040808S	5/16"	5/16"	10	7.20
SI041012S	5/16"	3/8"	10	7.91
SI041016S	5/16"	1/2"	10	6.55
SI041210S	3/8"	5/16"	10	8.03
SI041212S	3/8"	3/8"	10	8.88

**Elbow – Superseal x Superseal**

Order Code	Superseal OD	Superseal OD	Pack Size	List Price
SM400808S	5/16"	5/16"	10	13.32
SI401210S	3/8"	5/16"	10	13.99
SI401212S	3/8"	3/8"	10	14.59

**Elbow – Superseal x Speedfit**

Order Code	Superseal OD	Speedfit OD	Pack Size	List Price
SI030812S	1/4"	3/8"	10	10.64
SM030808S	5/16"	5/16"	10	8.19
SI031012S	5/16"	3/8"	10	9.51
SI031210S	3/8"	5/16"	10	11.14
SI031212S	3/8"	3/8"	10	11.19

**Flow Bend Connector – Superseal x Speedfit**

Order Code	Superseal OD	Speedfit OD	Pack Size	List Price
SM420808S	5/16"	5/16"	10	11.55
SI421012S	5/16"	3/8"	10	12.30
SI421210S	3/8"	5/16"	10	11.80
SI421212S	3/8"	3/8"	10	12.69

**Barb Connector**

Order Code	Superseal OD	Tube OD	Pack Size	List Price
SI270808S	1/4"	1/4"	10	4.97

**Superseal Spanner**

Order Code	Pack Size	List Price
SPAN1	1	11.51



Technical Information  
page 15

## Brass Fittings – MI Range

### Brass fittings for beverage dispense applications

The brass MI Range of fittings are designed for use in coffee brewing equipment, dispensing, and vending machine applications. The fittings are manufactured in brass with a polypropylene collet and a food grade EPDM O-Ring.

Temperature	Pressure	Temperature	Pressure
AIR/VACUUM	1/4" - 3/8"	POTABLE LIQUIDS	1/4" - 3/8"
NOT SUITABLE		DO NOT FREEZE	
		+1°C	1000kPa
		+20°C	1000kPa
		+60°C*	400kPa

\*NOT to exceed maximum temperature



### Brass Female Connector – FFL Thread

Order Code	Tube OD	Thread FFL	Pack Size	List Price
MI4508F4S	1/4"	1/4"	10	11.19
MI4512F4S	3/8"	1/4"	10	11.85

1/4 (FFL) corresponds to a 7/16 UNF.  
3/8 (FFL) corresponds to a 5/8 UNF.



### Brass Polypropylene Female Connector – BSPP Thread

Order Code	Tube OD	Thread BSPP	Pack Size	List Price
NC2145	1/4"	3/4"	10	12.96
NC2249	3/8"	3/4"	10	12.96



Technical Information  
page 15

### Acetal Fittings – CM Range

#### For drinks and other potable liquids

CM range of metric size fittings are manufactured in acetal. With a food grade EPDM O-Ring, they have been developed for the water industry but are equally suitable for other potable liquids.

The CM Range is NOT suitable for compressed air and vacuum applications. For these situations we recommend the Grey Acetal Fittings – PI Range and the Black Acetal Fittings – PM Range.

Temperature	Pressure	Temperature	Pressure
AIR/VACUUM	6 - 12mm	POTABLE LIQUIDS	6 - 12mm
NOT SUITABLE		DO NOT FREEZE	
		+1°C	1000kPa
		+20°C*	1000kPa
		+65°C*	700kPa

\*NOT to exceed maximum temperature

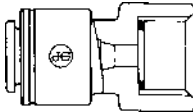

#### Female Adaptor – BSP Thread

Order Code	Tube OD	Tube BSP	Pack Size	List Price
CM451213FS	12mm	3/8"	10	8.50
NCCM451213FS	12mm	3/8" Short	10	8.50
CM451214FS	12mm	1/2"	10	9.52

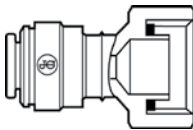

#### Female Tap Adaptor – BSP Thread / Cone End Seal

Order Code	Tube OD	Tube BSP	Pack Size	List Price
CM321014E	10mm	1/2"	10	6.54
CM321216E	12mm	3/4"	10	7.54



#### Straight Adaptor

Order Code	Tube OD	Thread BSP	Pack Size	List Price
CM011514S	15mm	1/2"	1	4.44



Standard JG Speedfit products can be coupled together to form integral new fittings:

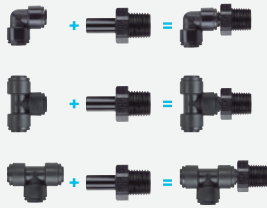

## Black Acetal Fittings – PM Range

### For liquids and inert gases

The PM Range of metric size fittings are manufactured in black acetal copolymer with food grade nitrile O-Rings. Being especially produced for foodstuffs and potable liquids, they are equally suitable for air and inert gases and can therefore be used on N<sub>2</sub>/CO<sub>2</sub> mixed gas dispense lines and pneumatic applications and vacuum (ensure products are installed in accordance with local codes of practice).

Temperature		Pressure		Temperature		Pressure		
AIR/VACUUM	4 - 8mm	10 - 22mm	POTABLE LIQUIDS	4 - 8mm	10 - 22mm			
-20°C	1600kPa	1000kPa	DO NOT FREEZE					
+1°C	1600kPa	1000kPa	+1°C	1600kPa	1000kPa			
+20°C	1600kPa	1000kPa	+20°C	1600kPa	1000kPa			
+65°C	1000kPa	700kPa	+65°C*	1000kPa	700kPa			

\*NOT to exceed maximum temperature



Technical Information  
page 15



Accessories  
page 61



Imperial to Metric  
Adaptors  
page 52



### Straight Adaptor – BSP Thread

Order Code	Tube OD	Thread BSP	Pack Size	List Price
PM010411E	4mm	1/8"	10	2.42
PM010412E	4mm	1/4"	10	3.76
PM010512E	5mm	1/4"	10	3.81
PM010611E	6mm	1/8"	10	3.31
PM010612E	6mm	1/4"	10	3.75
PM010811E	8mm	1/8"	10	3.56
PM010812E	8mm	1/4"	10	3.76
PM010813E	8mm	3/8"	10	4.75
PM011012E	10mm	1/4"	10	5.85
PM011013E	10mm	3/8"	10	6.34
PM011014E	10mm	1/2"	10	8.15
PM011213E	12mm	3/8"	10	8.01
PM011214E	12mm	1/2"	10	8.77
PM011513E	15mm	3/8"	10	6.71
PM011514E	15mm	1/2"	1	9.16
PM011516E *	15mm	3/4"	1	10.22
PM011814E	18mm	1/2"	1	9.69
PM012216E	22mm	3/4"	1	10.22

\* No thread seal.

**Straight Adaptor – BSPT Thread**

Order Code	Tube OD	Thread BSPT	Pack Size	List Price
PM010401E	4mm	1/8"	10	2.49
PM010402E	4mm	1/4"	10	3.56
PM010601E	6mm	1/8"	10	3.11
PM010602E	6mm	1/4"	10	3.56
PM010801E	8mm	1/8"	10	3.50
PM010802E	8mm	1/4"	10	3.56
PM010803E	8mm	3/8"	10	4.50
PM010804E	8mm	1/2"	10	6.18
PM011002E	10mm	1/4"	10	5.54
PM011003E	10mm	3/8"	10	5.98
PM011004E	10mm	1/2"	10	7.70
PM011203E	12mm	3/8"	10	7.58
PM011204E	12mm	1/2"	10	8.42

**Equal Straight Connector**

Order Code	Tube OD	Pack Size	List Price
PM0404E	4mm	10	3.90
PM0405E	5mm	10	3.96
PM0406E	6mm	10	4.05
PM0408E	8mm	10	4.50
PM0410E	10mm	10	5.93
PM0412E	12mm	10	6.92
PM0415E	15mm	1	7.42
PM0418E	18mm	1	8.24
PM0422E	22mm	1	10.37

**Reducing Straight Connector**

Order Code	Tube OD	Tube OD	Pack Size	List Price
PM200604E	6mm	4mm	10	4.59
PM200804E	8mm	4mm	10	4.59
PM200806E	8mm	6mm	10	4.75
PM201006E	10mm	6mm	10	5.59
PM201008E	10mm	8mm	10	5.15
PM201208E	12mm	8mm	10	6.92
PM201210E	12mm	10mm	10	8.08

**Equal Elbow**

Order Code	Tube OD	Pack Size	List Price
PM0304E	4mm	10	4.26
PM0306E	6mm	10	4.64
PM0308E	8mm	10	5.40
PM0310E	10mm	10	7.64
PM0312E	12mm	10	9.12
PM0315E	15mm	1	10.17
PM0318E	18mm	1	11.96
PM0322E	22mm	1	14.24

**Reducing Elbow Connector**

Order Code	Tube OD	Tube OD	Pack Size	List Price
PM210804E	8mm	4mm	10	5.78
PM210806E	8mm	6mm	10	5.98
PM211008E	10mm	8mm	10	8.08
PM211208E	12mm	8mm	10	8.01
PM211210E	12mm	10mm	10	8.41

**Stem Elbow**

Order Code	Tube OD	Stem OD	Pack Size	List Price
PM220404E	4mm	4mm	10	4.26
PM220606E	6mm	6mm	10	4.39
PM220808E	8mm	8mm	10	5.40
PM221010E	10mm	10mm	10	7.70
PM221212E	12mm	12mm	10	9.18
PM221515E	15mm	15mm	1	9.00
PM221818E	18mm	18mm	1	14.42
PM222222E	22mm	22mm	1	14.62

**Rigid Elbow – NPTF Thread**

Order Code	Tube OD	Thread NPTF	Pack Size	List Price
PM480621E	6mm	1/8"	10	2.35
PM480623E	6mm	3/8"	10	5.27

**Swivel Elbow – BSP Thread**

Order Code	Tube OD	Thread BSP	Pack Size	List Price
PM090512E	5mm	1/4"	10	6.24
PM090611E	6mm	1/8"	10	6.34
PM090612E	6mm	1/4"	10	6.53
PM090811E	8mm	1/8"	10	7.31
PM090812E	8mm	1/4"	10	7.44
PM090813E	8mm	3/8"	10	8.46
PM091012E	10mm	1/4"	10	10.05
PM091013E	10mm	3/8"	10	10.82
PM091014E	10mm	1/2"	10	12.46
PM091213E	12mm	3/8"	10	12.60
PM091214E	12mm	1/2"	10	13.95

**Swivel Elbow – BSPT Thread**

Order Code	Tube OD	Thread BSPT	Pack Size	List Price
PM090601E	6mm	1/8"	10	6.30
PM090602E	6mm	1/4"	10	6.42
PM090801E	8mm	1/8"	10	7.05
PM090802E	8mm	1/4"	10	7.19
PM090803E	8mm	3/8"	10	8.15
PM091002E	10mm	1/4"	10	9.74
PM091003E	10mm	3/8"	10	10.43
PM091004E	10mm	1/2"	10	12.07
PM091203E	12mm	3/8"	10	12.21
PM091204E	12mm	1/2"	10	13.55

**Equal Tee**

Order Code	Tube OD	Pack Size	List Price
PM0204E	4mm	10	5.65
PM0205E	5mm	10	5.98
PM0206E	6mm	10	6.24
PM0208E	8mm	10	6.82
PM0210E	10mm	10	8.08
PM0212E	12mm	10	9.66
PM0215E	15mm	1	13.39
PM0218E	18mm	1	13.73
PM0222E	22mm	1	15.07

**Reducing Tee**

Order Code	Tube OD Ends	Tube OD Branch	Pack Size	List Price
PM3018AE	18mm	15mm	1	16.21
PM3022AE	22mm	15mm	1	16.21

**Swivel Tee – Centre Leg BSP Thread**

Order Code	Tube OD	Thread BSP	Pack Size	List Price
PM100611E	6mm	1/8"	10	7.75
PM100813E	8mm	3/8"	10	10.05
PM101012E	10mm	1/4"	10	10.62
PM101213E	12mm	3/8"	5	13.60
PM101214E	12mm	1/2"	5	15.06

**Swivel Tee – Centre Leg BSPT Thread**

Order Code	Tube OD	Thread BSPT	Pack Size	List Price
PM100801E	8mm	1/8"	10	8.41
PM100802E	8mm	1/4"	10	8.60

**Bulkhead Connector**

Order Code	Tube OD	Pack Size	List Price
PM1204E	4mm	10	5.54
PM1205E	5mm	10	6.38
PM1206E	6mm	10	6.53
PM1208E	8mm	10	6.68
PM1210E	10mm	10	10.27
PM1212E	12mm	5	11.05

For 1/4" x 6mm size see Grey Acetal Fittings – PI Range.

**Reducer**

Order Code	Stem OD	Tube OD	Pack Size	List Price
PM060604E	6mm	4mm	10	2.82
PM060605E	6mm	5mm	10	2.87
PM060804E	8mm	4mm	10	3.46
PM060805E	8mm	5mm	10	3.46
PM060806E	8mm	6mm	10	3.49
PM061006E	10mm	6mm	10	3.69
PM061008E	10mm	8mm	10	4.14
PM061208E	12mm	8mm	10	4.58
PM061210E	12mm	10mm	10	7.95
PM061510E	15mm	10mm	1	8.60
PM061512E	15mm	12mm	1	8.81
PM061815E	18mm	15mm	1	9.31
PM062215E	22mm	15mm	1	10.35
PM062218E	22mm	18mm	1	10.35

**Stem Adaptor – BSP Thread**

Order Code	Stem OD	Thread BSP	Pack Size	List Price
PM050411E	4mm	1/8"	10	1.52
PM050412E	4mm	1/4"	10	1.62
PM050512E	5mm	1/4"	10	1.62
PM050611E	6mm	1/8"	10	1.53
PM050612E	6mm	1/4"	10	1.64
PM050811E	8mm	1/8"	10	1.53
PM050812E	8mm	1/4"	10	1.64
PM051012E	10mm	1/4"	10	2.10
PM051013E	10mm	3/8"	10	2.67
PM051014E	10mm	1/2"	10	4.39
PM051213E	12mm	3/8"	10	3.03
PM051214E	12mm	1/2"	10	4.39
PM051513E	15mm	3/8"	1	4.02
PM051514E	15mm	1/2"	1	5.95
PM051814E	18mm	1/2"	1	5.95
PM052214E	22mm	1/2"	1	6.33
PM052216E	22mm	3/4"	1	7.44

**Stem Adaptor – BSPT Thread**

Order Code	Stem OD	Thread BSPT	Pack Size	List Price
PM050401E	4mm	1/8"	10	1.46
PM050402E	4mm	1/4"	10	1.59
PM050601E	6mm	1/8"	10	1.48
PM050801E	8mm	1/8"	10	1.48
PM050802E	8mm	1/4"	10	1.53
PM050803E	8mm	3/8"	10	2.36
PM051003E	10mm	3/8"	10	2.36
PM051004E	10mm	1/2"	10	3.95
PM051203E	12mm	3/8"	10	2.73
PM051204E	12mm	1/2"	10	3.95

**Two-Way Divider**

Order Code	Tube OD	Pack Size	List Price
PM2304E	4mm	10	6.30
PM2308E	8mm	10	7.31
PM2310E	10mm	10	7.88

**Plug**

Order Code	Colour	Stem OD	Pack Size	List Price
PM0804R	Red	4mm	10	1.10
PM0805R	Red	5mm	10	1.14
PM0806R	Red	6mm	10	1.27
PM0808R	Red	8mm	10	1.46
PM0810R	Red	10mm	10	2.67
PM0812R	Red	12mm	10	3.18
PM0815E	Black	15mm	1	3.49
PM0818E	Black	18mm	1	3.65
PM0822E	Black	22mm	1	4.11

**Tube To Hose Stem**

Order Code	Stem OD	Hose ID	Pack Size	List Price
PM250806E	8mm	6mm	10	4.00
PM251008E	10mm	8mm	10	4.20



**End Stop**

Order Code	Tube OD	Pack Size	List Price
PM4612E	12mm	10	6.49
PM4615E	15mm	1	7.20
PM4622E	22mm	1	8.37

**Female Adaptor**

Order Code	Tube OD	Thread BSP	Pack Size	List Price
PM450411E*	4mm	1/8"	10	3.94
PM450611E	6mm	1/8"	10	4.83
PM450612E*	6mm	1/4"	10	4.92
PM450812E	8mm	1/4"	10	5.09
PM450813E	8mm	3/8"	10	4.74
PM451015FE*	10mm	5/8"	10	13.73

\* With thread seal. Other sizes, no seal.

**U-Bend**

Order Code	Tube OD	Pack Size	List Price
PMUB15E	15mm	1	11.40

 Technical Information  
page 15

 Accessories  
page 61

 Imperial to Metric  
Adaptors  
page 52

## White Polypropylene Fittings – PPM Range

### For potable liquids

The PPM Range of metric size push-to-connect fittings are produced in white polypropylene, and fitted with EPDM seals. Polypropylene has the advantage of being more chemically resistant than acetal.

Temperature	Pressure	Temperature	Pressure
AIR/VACUUM	8mm - 15mm	POTABLE LIQUIDS	8mm - 15mm
		DO NOT FREEZE	
		+1°C	1000kPa
		+20°C	1000kPa
		+60°C*	400kPa

Not Suitable

\*NOT to exceed maximum temperature



### Equal Straight Connector

Order Code	Tube OD	Pack Size	List Price
PPM0408W	8mm	10	4.85



### Equal Elbow

Order Code	Tube OD	Pack Size	List Price
PPM0308W	8mm	10	5.66



### Stem Elbow

Order Code	Stem OD	Tube OD	Pack Size	List Price
PPM220808W	8mm	8mm	10	5.84



### Equal Tee

Order Code	Tube OD	Pack Size	List Price
PPM0208W	8mm	10	7.32



### Plug

Order Code	Stem OD	Pack Size	List Price
PPM0808W	8mm	10	1.38



### Divider

Order Code	Stem OD	Pack Size	List Price
PPM2312W	12mm	10	12.66



Technical Information  
page 15

## Metric to Imperial Adaptors

Converts metric sizes to inch and inch sizes to metric

Temperature	Pressure	Temperature	Pressure
AIR/VACUUM	1/2" - 15mm	POTABLE LIQUIDS	1/2" - 15mm
Refer To Ratings of Ranges Adapting Between		Refer To Ratings of Ranges Adapting Between	



### Straight Connector

Order Code	Tube OD	Tube OD	Pack Size	List Price
NC462	15mm	1/2"	1	7.23



### Unequal Straight Connector

Order Code	Tube OD	Tube OD	Pack Size	List Price
NC2511	15mm	3/8"	1	5.14



### Stem to Tube Adaptor

Order Code	Stem OD	Tube OD	Pack Size	List Price
NC2164	15mm	3/8"	1	7.09
NC2173	1/2"	15mm	1	11.20



### Stem to Hose Connector

Order Code	Stem OD	Hose ID	Pack Size	List Price
NC932	15mm	1/2"	1	6.13



### Tube to Hose Connector

Order Code	Tube OD	Hose ID	Pack Size	List Price
NC448	15mm	1/2"	1	5.65



### Stem to Stem Adaptor

Order Code	Stem OD	Stem OD	Pack Size	List Price
NC478	15mm	3/8"	1	7.10



Technical Information  
page 15

● **1/4 Turn Valves** are designed to allow temporary servicing of downstream equipment and must only be used in the fully open or fully closed position. **Do not use these valves:** in a partially open position to control flow; to provide a permanent termination; without tubing assembled or plugged (or threaded connections sealed); or as a tap.

## Acetal Stop Valves

Acetal Stop Valves are not to be used with compressed air, explosive gases, petroleum spirit and other fuels, or for heating systems.

### Angle Stop Valves

Angle Stop Valves have an Acetal body, EPDM O-Rings, incorporate a single check valve and a 1/4 turn chromium plated ball valve.

The valves are for use with potable water. For use with other potable liquids please refer to our Customer Service Department for guidance.

Temperature	Pressure	Temperature	Pressure
AIR/VACUUM	3/8" - 1/2" - 15mm	POTABLE LIQUIDS	3/8" - 1/2" - 15mm
		DO NOT FREEZE	
		+1°C	1200kPa
		+20°C	1200kPa
		+65°C*	600kPa

Not Suitable

\*NOT to exceed maximum temperature



### Acetal Angle Stop Valve – Metric to Imperial ●

Order Code	Tube OD	Tube OD Branch	Pack Size	List Price
ASV3	15mm	1/4"	1	31.27

### Acetal Angle Stop Valve – Imperial ●

Order Code	MxF BSP Threads	Tube OD Branch	Pack Size	List Price
ASV8	1/2"	3/8"	1	42.12
ASV10	1/2"	1/4"	1	42.12



Technical Information  
page 15



Accessories  
page 61

● **1/4 Turn Valves** are designed to allow temporary servicing of downstream equipment and must only be used in the fully open or fully closed position. Do not use these valves: in a partially open position to control flow; to provide a permanent termination; without tubing assembled or plugged (or threaded connections sealed); or as a tap.

## Shut-Off Valves

### White Polypropylene Shut-Off Valves for potable water

The PP Range of shut-off valves are produced in polypropylene and fitted with EPDM seals. Polypropylene has the advantage of being more chemically resistant than acetal.

The valves are for use with potable water. For use with other potable liquids, please refer to our Customer Service Department for guidance.

The valves are not to be used with compressed air, explosive gases, petroleum spirits and other fuels or for heating systems.

Temperature	Pressure	Temperature	Pressure
AIR/VACUUM	1/4" - 3/8" 6mm - 12mm	POTABLE LIQUIDS	1/4" - 3/8" 6mm - 12mm
DO NOT FREEZE			
Not Suitable		+1°C	1000kPa
		+20°C	1000kPa
		+60°C*	400kPa

\*NOT to exceed maximum temperature



### Shut-Off Valve – Speedfit to Speedfit ●

Order Code	Tube OD	Pack Size	List Price
PPSV040808W	1/4"	1	12.56
PPSV041212W	3/8"	1	13.22
PPMSV040606W	6mm	1	12.56
PPMSV040808W	8mm	1	13.05
PPMSV041010W	10mm	1	13.22
PPMSV041212W	12mm	1	20.70



### Shut-Off Valve – Speedfit to Male NPTF Thread ●

Order Code	Tube OD	Thread NPTF	Pack Size	List Price
PPSV010822W	1/4"	1/4"	1	12.56
PPSV011223W	3/8"	3/8"	1	13.22



### Shut-Off Valve – Speedfit to Female NPTF Thread ●

Order Code	Tube OD	Thread NPTF	Pack Size	List Price
PPSV500822W	1/4"	1/4"	1	14.27
PPSV501222W	3/8"	1/4"	1	14.90



### Mounting Clip

Order Code	Size	Pack Size	List Price
SVMC-06	6mm / 1/4"	1	3.64
SVMC-10	10mm / 3/8"	1	3.64

The mounting clip is designed to give a very firm grip. A twisting action is needed to remove the valve. The clip can be used with either shut off valve. When used with the short handle version, valves can be banked together.



Technical Information  
page 15

● **1/4 Turn Valves** are designed to allow temporary servicing of downstream equipment and must only be used in the fully open or fully closed position. Do not use these valves: in a partially open position to control flow; to provide a permanent termination; without tubing assembled or plugged (or threaded connections sealed); or as a tap.

## Shut-Off Valves

### Grey Acetal Shut-Off Valves for liquids and inert gases

Acetal Shut-Off Valves have a full bore mechanism, and are especially designed for the Brewing and Soft Drinks Industries and for potable water. They are also suitable for air and inert gases such as N<sub>2</sub>/CO<sub>2</sub> to a maximum temperature of 50°C (ensure products are installed in accordance with local codes of practice).

The range includes valves with short and long handles to operate a 1/4 turn on/off action. Some valves are available with integral mounting bosses.

Temperature	Pressure	Temperature	Pressure
<b>AIR/VACUUM</b>	<b>3/8" - 1/2"</b>	<b>POTABLE LIQUIDS</b>	<b>3/8" - 1/2"</b>
-20	1000kPa	DO NOT FREEZE	
+1°C	1000kPa	+1°C	1000kPa
+23°C	1000kPa	+23°C	1000kPa
+65°C*	700kPa	+65°C*	700kPa

\*NOT to exceed maximum temperature



### Shut-Off Valve – Short Handle ●

Order Code	Tube OD	Pack Size	List Price
PISV0412CS	3/8"	1	28.04



### Shut-Off Valve – Long Handle ●

Order Code	Tube OD	Pack Size	List Price
PISV0412S	3/8"	1	28.04
PISV0416S	1/2"	1	28.42



### Angle Stop Valve ●

Order Code	Tube OD	Pack Size	List Price
NC2555	3/8"	1	22.02

Features double O-Rings in each of the Speedfit ports and has been developed for a wide range of applications including foodstuffs, potable liquids and air.



Technical Information  
page 15



Accessories  
page 61

## Check Valves and Service Valves

### Single Check Valves

Produced specifically for the drinks dispense industry, the Speedfit acetal Single Check Valve ensures protection against reversal of flow.

The low headloss design and fast installation time makes the valve the ideal selection. The valve is designed for use with liquids, it is not suitable for air and vacuum applications.

Temperature	Pressure	Temperature	Pressure
AIR/VACUUM	1/4" - 3/8" 6mm - 12mm	POTABLE LIQUIDS	1/4" - 3/8" 6mm - 12mm
Not Suitable		DO NOT FREEZE	
		+1°C	1000kPa
		+20°C	1000kPa
		+65°C*	700kPa

\*NOT to exceed maximum temperature

#### Notes

- Typical 'crack open' pressure 2kPa.
- Valves with low fixed cracking pressure (i.e 10cm water column), that have not been activated for some time may take several seconds to re-seal.
- It is the responsibility of the end user to verify that the product is suitable for the specific application.
- It is also recommended that the non-return valve is regularly checked and maintained.



### Single Check Valve – Imperial

Order Code	Tube OD	Pack Size	List Price
1/4SCV	1/4"	10	22.75
5/16SCV	5/16"	10	30.78
3/8SCV	3/8"	10	32.13

For use with liquids only.



### Single Check Valve – Metric

Order Code	Tube OD	Pack Size	List Price
6SCV	6mm	10	24.83
10SCV	10mm	1	36.68
12SCV	12mm	10	29.16

For use with liquids only.





Technical Information  
page 15



Accessories  
page 61

● **1/4 Turn Valves** are designed to allow temporary servicing of downstream equipment and must only be used in the fully open or fully closed position. Do not use these valves: in a partially open position to control flow; to provide a permanent termination; without tubing assembled or plugged (or threaded connections sealed); or as a tap.

## Check Valves and Service Valves

### Double Check and Service Valves – Metric

Double Check Valves ensure the prevention of contamination arising from back syphonage, back flow and cross connection. A spring loaded internal check valve is sited either side of the test cock, and an arrow identifies the direction of flow. The low headloss design and fast installation time makes this unit the ideal selection. The valve can be mounted in any position.

Service Valves are ideally suited to provide a temporary shut-off facility in a drinks dispense situation. The valve consists of a ball mechanism operated by means of a screwdriver slot.

Temperature	Pressure	Temperature	Pressure
AIR/VACUUM	15mm	POTABLE LIQUIDS	15mm
		DO NOT FREEZE	
		+1°C	1200kPa
		+20°C	1200kPa
		+65°C*	600kPa

Not Suitable

\*NOT to exceed maximum temperature

#### Notes

- Valves with low fixed cracking pressure (i.e 10cm water column), that have not been activated for some time may take several seconds to re-seal.
- It is the responsibility of the end user to verify that the product is suitable for the specific application.
- It is also recommended that the non-return valve is regularly checked and maintained.



### Double Check Valve – Metric

Order Code	Tube OD	Pack Size	List Price
15DCV	15mm	1	28.64

For use with liquids only.



### Double Check Service Valve – Metric ●

Order Code	Tube OD	Pack Size	List Price
15DCSV	15mm	1	49.52

For use with liquids only.



### Service Valve – Metric ●

Order Code	Tube OD	Pack Size	List Price
15SV	15mm	1	15.10

For use with liquids only.



Technical Information  
page 15



Accessories  
page 61

● **1/4 Turn Valves** are designed to allow temporary servicing of downstream equipment and must only be used in the fully open or fully closed position. Do not use these valves: in a partially open position to control flow; to provide a permanent termination; without tubing assembled or plugged (or threaded connections sealed); or as a tap.

## Check Valves and Service Valves

### Service Valves – Imperial

Speedfit Service Valves are ideally suited to provide a temporary shut-off facility in a drinks dispense situation.

The valve consists of a ball mechanism operated by means of a screwdriver slot.

Push-to-connect fittings make for a fast installation time, especially in confined spaces.

The valve can also be used for domestic hot and cold water supplies.

Temperature	Pressure	Temperature	Pressure
AIR/VACUUM	1/2"	POTABLE LIQUIDS	1/2"
		DO NOT FREEZE	
		+1°C	1000kPa
		+20°C	1000kPa
		+65°C*	700kPa

\*NOT to exceed maximum temperature

#### Notes

- Valves with low fixed cracking pressure (i.e 10cm water column), that have not been activated for some time may take several seconds to re-seal.
- It is the responsibility of the end user to verify that the product is suitable for the specific application.
- It is also recommended that the non-return valve is regularly checked and maintained.



### Service Valve – Imperial ●

Order Code	Tube OD	Pack Size	List Price
1/2ISV	1/2"	1	21.41

For use with liquids only.

 Technical Information  
page 16

## LLDPE Tube – PE Range

### Strong yet flexible

The John Guest PE Range of plastic tubing is produced in Linear Low Density Polyethylene for cold and intermittent hot water applications.

Our LLDPE tubing provides the benefits of a wide range of temperature and pressure suitability, broad chemical compatibility, and is made from non contaminating materials. Common applications being water purification, water conditioners, ice makers and misting systems. LLDPE is more robust than traditional low or medium density polyethylene and is recommended for use with cold and intermittent hot water.

Our tubing is made from FDA approved materials and is NSF International certified.

John Guest Polyethylene tubing is designed for use with John Guest Speedfit Push-to-connect fittings, John Guest Shut-Off Valves, and virtually all standard tubing connectors.

Tube OD	Tube ID	Maximum Pressure and Temperature
1/4"	0.170"	1600kPa at 20°C 800kPa at 65°C
5/16"	0.187"	
3/8"	0.25"	
4mm	2.5mm	
6mm	4mm	
10mm	7mm	
1/2"	0.375"	1000kPa at 20°C 600kPa at 65°C
8mm	6mm	
12mm	9mm	
15mm	11.5mm	

### Maximum Working Temperature 65°C at pressures shown in chart above.

The above maximum temperatures and pressures do not take chlorine content into account. This could reduce service life. Please note maximum pressure rating for a system depends on the lowest rated component, eg. most John Guest fittings have a different rating from the tube ratings shown above.

Burst pressures are approximately 3 times the maximum working pressure.



### LLDPE Tube – Imperial Sizes

Order Code	Tube OD	Colour	Coil Length	List Price
PE-08-BI-0500F-B	1/4"	Blue	500ft (152m)	77.78
PE-08-BI-0500F-E	1/4"	Black	500ft (152m)	77.78
PE-08-BI-0500F-G	1/4"	Green	500ft (152m)	77.78
PE-08-BI-0500F-N	1/4"	Natural	500ft (152m)	73.70
PE-08-BI-0500F-O	1/4"	Orange	500ft (152m)	77.78
PE-08-BI-0500F-R	1/4"	Red	500ft (152m)	77.78
PE-08-BI-0500F-V	1/4"	Violet	500ft (152m)	82.52
PE-08-BI-0500F-W	1/4"	White	500ft (152m)	77.78
PE-08-BI-0500F-Y	1/4"	Yellow	500ft (152m)	77.78
PE-08-BI-1000F-B	1/4"	Blue	1000ft (304m)	155.59
PE-08-BI-1000F-W	1/4"	White	1000ft (304m)	155.59
PE-10-CI-0500F-B	5/16"	Blue	500ft (152m)	111.04
PE-10-CI-0500F-E	5/16"	Black	500ft (152m)	111.04
PE-10-CI-0500F-N	5/16"	Natural	500ft (152m)	111.04
PE-10-CI-0500F-R	5/16"	Red	500ft (152m)	111.04
PE-10-CI-0500F-W	5/16"	White	500ft (152m)	111.04

**LLDPE Tube – Imperial Sizes (continued)**

Order Code	Tube OD	Colour	Coil Length	List Price
PE-12-EI-0500F-B	3/8"	Blue	500ft (152m)	155.59
PE-12-EI-0500F-E	3/8"	Black	500ft (152m)	155.59
PE-12-EI-0500F-G	3/8"	Green	500ft (152m)	155.59
PE-12-EI-0500F-N	3/8"	Natural	500ft (152m)	143.31
PE-12-EI-0500F-O	3/8"	Orange	500ft (152m)	155.59
PE-12-EI-0500F-R	3/8"	Red	500ft (152m)	155.59
PE-12-EI-0500F-W	3/8"	White	500ft (152m)	155.59
PE-12-EI-0500F-Y	3/8"	Yellow	500ft (152m)	155.59
PE-16-GI-0250F-B	1/2"	Blue	250ft (76m)	116.39
PE-16-GI-0250F-E	1/2"	Black	250ft (76m)	116.39
PE-16-GI-0250F-N	1/2"	Natural	250ft (76m)	112.28
PE-16-GI-0250F-R	1/2"	Red	250ft (76m)	116.39

**LLDPE Tube – Metric**

Order Code	Tube OD	Colour	Coil Length	List Price
PE-04025-0100M-B	4mm	Blue	100m	36.22
PE-04025-0100M-E	4mm	Black	100m	36.22
PE-04025-0100M-N	4mm	Natural	100m	36.22
PE-0604-0100M-B	6mm	Blue	100m	48.81
PE-0604-0100M-E	6mm	Black	100m	48.81
PE-0604-0100M-N	6mm	Natural	100m	48.81
PE-0604-0100M-R	6mm	Red	100m	48.81
PE-0806-100M-B	8mm	Blue	100m	75.83
PE-0806-100M-E	8mm	Black	100m	75.83
PE-0806-100M-N	8mm	Natural	100m	75.83
PE-0806-100M-R	8mm	Red	100m	75.83
PE-1007-100M-B	10mm	Blue	100m	116.38
PE-1007-100M-E	10mm	Black	100m	116.38
PE-1007-100M-N	10mm	Natural	100m	112.28
PE-1007-100M-R	10mm	Red	100m	116.38
PE-1209-100M-B	12mm	Blue	100m	124.42
PE-1209-100M-E	12mm	Black	100m	124.42
PE-1209-100M-N	12mm	Natural	100m	112.28
PE-1209-100M-R	12mm	Red	100m	124.42
PE-15115-0100M-B	15mm	Blue	100m	226.01
PE-15115-0100M-G	15mm	Green	100m	226.01
PE-15115-0100M-R	15mm	Red	100m	226.01



## Accessories

### Collets

Collets can be secured into position using a Locking Clip, preventing accidental disconnection, as shown in the image on the left.

Slip-on Collet Covers, as shown in the illustration on the left, prevents accidental removal or tampering with tubing. Tubing can be inserted with the Collet Cover already attached to the fittings, or the cover can slide into position afterwards. The Collet Cover is easily removed when required and comes in a variety of colours for colour coding.

#### Colours available and suffix indication

- S = Grey
- B = Blue
- R = Red
- Y = Yellow
- E = Black



### Collet Cover – Imperial

Order Code	Tube OD	Colour	Pack Size	List Price
PI1908B	1/4"	Blue	10	0.50
PI1908R	1/4"	Red	10	0.50
PI1908S	1/4"	Grey	10	0.50
PI1916B	1/2"	Blue	10	0.68

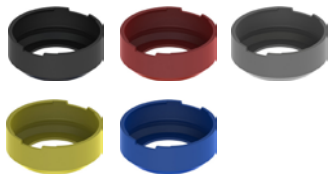

### Collet Cover – Metric

Order Code	Tube OD	Colours	Pack Size	List Price
PM1905E	5mm	Black	10	0.43
PM1906R	6mm	Red	10	0.57
PM1906S	6mm	Grey	10	0.57
PM1908E	8mm	Black	10	0.65
PM1908Y	8mm	Yellow	10	0.65
PM1912B	12mm	Blue	10	0.76
PM1912E	12mm	Black	10	0.76
PM1912R	12mm	Red	10	0.76
PM1915B	15mm	Blue	10	0.36
PM1915E	15mm	Black	10	0.71
PM1915R	15mm	Red	10	0.36
PM1918E	18mm	Black	10	0.71
PM1922E	22mm	Black	10	0.74
PM1922R	22mm	Red	10	0.43



### Flow Bend Clip

Order Code	Tube OD (Metric)	Tube OD (Imperial)	Pack Size	List Price
PM2608S	8mm	5/16"	10	2.49
PM2610S	10mm	3/8"	10	2.49
PM2612S	12mm	1/2"	10	2.81

Designed to support tube and eliminate kinking.



### Tube Insert – Imperial

Order Code	Tube OD	Tube ID	Pack Size	List Price
TSI375S	1/2"	3/8"	10	0.46

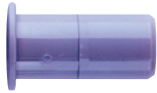

### Tube Insert – Metric

Order Code	Tube OD	Tube ID	Pack Size	List Price
TSM10N	10mm	7mm	50	0.75
TSM1209S	12mm	9mm	1	0.51
TSM15N	15mm	11.5mm	1	0.54



### Plug

Order Code	Stem OD	Colour	Pack Size	List Price
PM0804R	4mm	Red	10	1.10
PM0805R	5mm	Red	10	1.14
PM0806R	6mm	Red	10	1.27
PM0808R	8mm	Red	10	1.46
PM0810R	10mm	Red	10	2.67
PM0812R	12mm	Red	10	3.18
PM0815E	15mm	Black	1	3.49
PM0818E	18mm	Black	1	3.65
PM0822E	22mm	Black	1	4.11



### Collet Locking Tool

Order Code	Size	Pack Size	List Price
ICLT/2	3/16" to 1/2"	1	17.11



### Tube Cutter

Order Code	Pack Size	List Price
TSNIP	1	12.39
BLADES	Replacement blades for TSNIP	6.51

Suitable for up to 12mm tube.



### Pipe Cutter

Order Code	Pack Size	List Price
------------	-----------	------------

JG-TS	1	73.73
-------	---	-------

Suitable for up to 22mm pipe.



### Locking Clip - Imperial

Order Code	Tube OD	Pack Size	List Price
------------	---------	-----------	------------

PIC1808R	1/4"	100	0.54
----------	------	-----	------

PIC1812R	3/8"	100	0.59
----------	------	-----	------

PIC1816R	1/2"	100	0.59
----------	------	-----	------



### Locking Clip - Metric

Order Code	Tube OD	Pack Size	List Price
------------	---------	-----------	------------

PM1806R	6mm	100	0.43
---------	-----	-----	------

PM1808R	8mm	100	0.43
---------	-----	-----	------

PM1810R	10mm	100	0.43
---------	------	-----	------

PM1812R	12mm	100	0.51
---------	------	-----	------

PMC1815R	15mm	100	0.55
----------	------	-----	------





# Speedfit

## Compressed Air System

## Speedfit Compressed Air Technical Specifications

Fittings and pipe should be kept clean and undamaged before use.

### Applications

The John Guest Speedfit range of push-to-connect fittings and pipe provide the ideal connection, from compressor receiver to air line service components, through to complete ring main and take off points.

The system is not recommended for use with explosive gases, petroleum spirits and other fuels, or for central heating systems.

### Sizes

12mm, 15mm, 18mm, 22mm and 28mm outside diameter (OD) pipe.

### Installation

The pressure rating and installation guidelines of the tubing employed must also be considered during the design of the compressed air system.

Pipe should be supported between 600mm to 800mm to prevent excessive load being applied to the fitting(s). These supports should not be closer than 25mm from the end of the fitting.

Speedfit fittings and pipe should only be connected after the air receiver, and not directly to a compressor.

It is recommended that collet covers be fitted when pipework is hidden inside walls and ceilings.

It is recommended that all pipe and fittings installations are pressure tested after installation, and before handing over to the final user.

### Material Specification

The fittings are made up of three components:

- **Bodies** are produced in strong engineering plastic or in brass.
- **O-Rings** are nitrile rubber.
- **Collets** are produced in acetal copolymer with stainless steel teeth

### Pipe Types

Speedfit fittings are intended for use with John Guest nylon pipe but are also suitable for use with a wide range of plastic and soft metal pipes including UPVC, ABS, polyethylene, nylon, mild steel and copper to the tolerances set out below. Soft plastic pipe, such as nylon, has to have a minimum wall thickness of 1.5mm. The pipe must have a good quality surface and be damage free.

Note: Aluminium pipe should NOT be connected directly to a compressor.

### Pipe Tolerances

The Speedfit fittings featured in this manual are intended for pipes with outside diameters to the following tolerances;

Size	Tolerance
12mm to 28mm OD	+0.05 to -0.10mm

### Maximum Torque Figures

The following maximum torque values should be applied.

Size	Plastic Threads	Brass Threads
3/8"	3.0Nm	N/A
1/2"	3.0Nm	4.0Nm
3/4"	4.0Nm	5.0Nm
1"	5.0Nm	5.0Nm

It is recommended that all installations are checked prior to use, to determine that a seal has been made. The maximum torque figures quoted for use with Speedfit fittings are dependent on the mating thread conforming to the relevant British or International thread standard.

Do not over tighten plastic fittings, as this could cause undue stress and eventual failure. Recommended torque figures are shown above and must be adhered to. John Guest recommends OEM Customers consider replacing threaded ports with the modern method of using John Guest Cartridge Systems.

## Side Loads

John Guest products are not designed to be used whilst under side load, as this may adversely affect their ability to function long-term. Always ensure tubes have good alignment with the fitting. They must also not be subjected to any form of impact or other damage, such as being hit or dropped, even accidentally. If fittings are damaged or suffer an impact, they should be replaced immediately. RWC warranty does not cover loss caused by any form of damage.

## Condensate and Dirt in the System

It is always desirable to have clean, dry air at the outlets of a compressed air system, as condensate and dirt will affect the performance and life of ancillary equipment. We would strongly recommend that a filter be fitted to the system to clean the air, and that John Guest Water Trap Tees be used to trap any residual condensate, and this should be taken to a 'drain off' facility to extract it from the system.

## How To Make A Connection – Speedfit Compressed Air Fittings

The John Guest Speedfit push-to-connect fitting has a collet (gripper) with stainless steel teeth which hold the pipe firmly in position, and an O-Ring to provide a permanent leakproof seal.

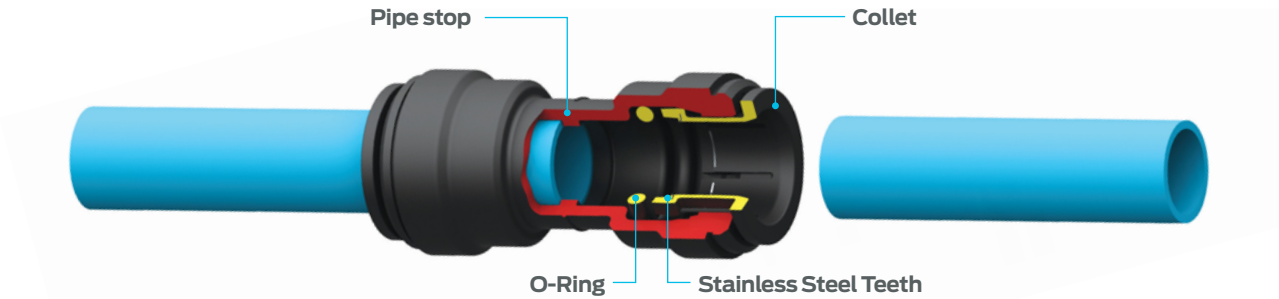

### Making A Good Connection

Fittings and pipe should be kept in their original packaging to ensure they are clean and undamaged before use.

#### Prepare the Pipe

Ensure the pipe is free of score marks. Cut the pipe square. We recommend the use of JG Pipe Cutters.

DO NOT use a hacksaw. To prevent damage to the O-Ring, remove all burrs and sharp edges.

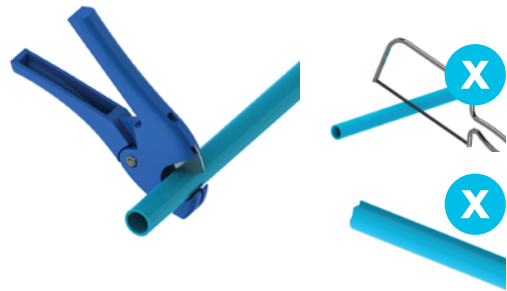

#### Push Up To Pipe Stop

Push the pipe into the fitting, to the pipe stop.

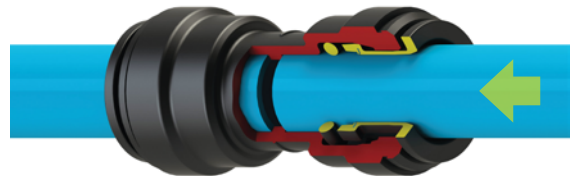

#### Pull To Check Secure

Pull on the pipe to check it is secure. Test the system before use.



#### To Disconnect

Push in collet and remove pipe.

To disconnect, ensure the system is depressurized, push the collet square against the fitting. With the collet held in this position the pipe can be removed.



## 28mm Fittings

28mm fittings also have a collet with stainless steel teeth and an O-Ring.

After inserting the pipe, a screw cap is turned approx 1/4 turn. This locks the collet in place and reduces lateral and sideways movement of the pipe.

### To Disconnect

Turn the screw cap 1/4 turn, push in the collet and remove the pipe. The fitting and pipe can be reused.

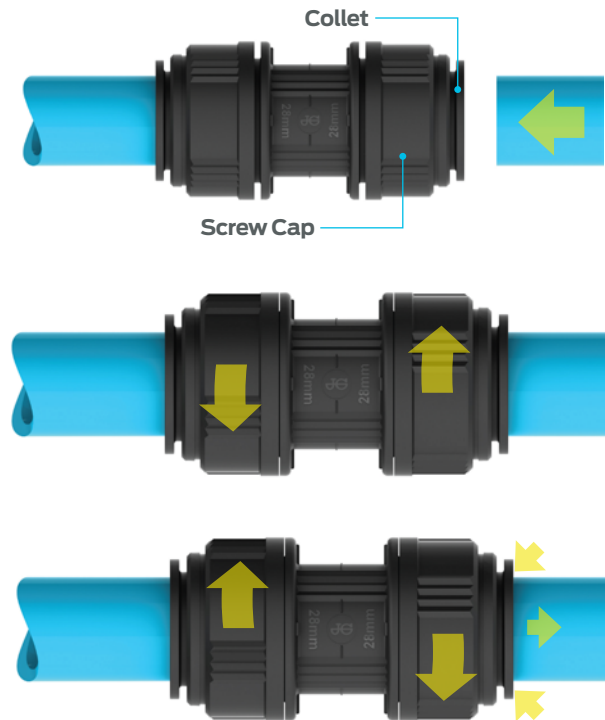

## Water Trap Tee and Water Trap Tee Converter

### Water Trap Tee

The Water Trap Tee from John Guest solves the on-going problem of moisture in a compressed air system, and provides the easy alternative for the need to install 'Swan Necks'.

The ingenious inside arrangement of the fitting allows air to flow, with minimum head loss, from the main to take-off point, without allowing water to follow. The moisture is retained in the line to be drawn off at a suitable location.

### Installation

It is of vital importance, for the correct function of the Water Trap Tee, that the air distribution system be nearly horizontal, and that the outlet port be facing downwards.



### Water Trap Tee Converter

The Water Trap Tee Converter is a simple convenient way of converting a standard John Guest 28mm Tee to a Water Trap Tee. This will stop condensing water entering the vertical take off spur.

The air supply needs to be installed with the correct fall and water drain points regularly vented.

### To Assemble

Use either John Guest 28mm nylon pipe or 28mm copper pipe. The pipe must be cut square, and be free of burrs.

Press the shorter spigot into the pipe. The fit on copper pipe will be loose. This will not affect the function.

Push the pipe and converter up to the pipe stop of the centre leg of the tee.

Turn the screw cap approx 1/4 turn to lock the pipe in position.

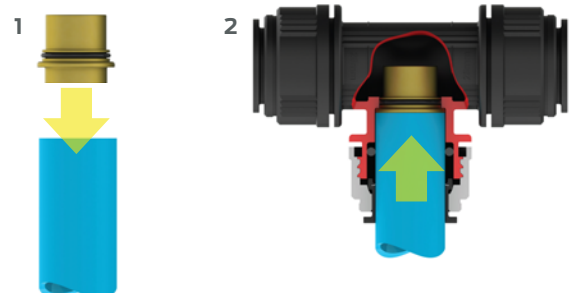



## Installing A Speedfit Compressed Air System

Thermoplastics have different properties to steel pipes and so different techniques need to be employed for the installation of the system. For example, plastic pipe expands considerably more than metallic pipe, so the method to constrain the pipe needs to be suitable for this expansion to take place. If the pipe is constrained at both ends, it will buckle and generate side loads and stress in the pipe. This can be alleviated by an expansion bend in the pipe work.

Pipe should be able to slide through mounting brackets. Plastic pipe work is much lighter than that of steel pipe work and so the mountings do not need to be as robust, and using John Guest connectors means that the system can be easily modified to any new requirements, quickly and without significant specialist tools, such as threading equipment and pipe benders. Using John Guest connectors means that no solvents or adhesives need to be employed in the installation. The coefficient of linear expansion of rigid nylon pipe is approximately 0.00012 metre per metre length per °C.

John Guest compressed air equipment is suitable to use above ground and below ground, but we would strongly suggest that if it is installed below ground, it is installed inside conduit, so that the pipe can expand with temperature fluctuations and be easily removed for service or maintenance.

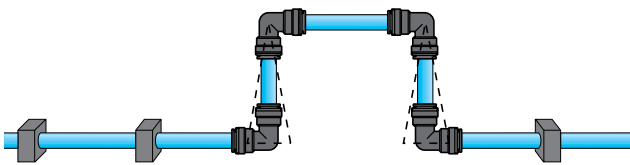

On long pipe runs, it is advisable to install an expansion bend, as shown in the diagram.

### Compressed Air System Installation

When installing a compressed air system, it is advisable to first attach the horizontal pipe clips and only attach the clips to the vertical pipes, after a small amount of pressure has been applied to the system. This will ensure that the vertical pipes have positioned themselves correctly before they are clipped.

#### Phase 1: System without pressure

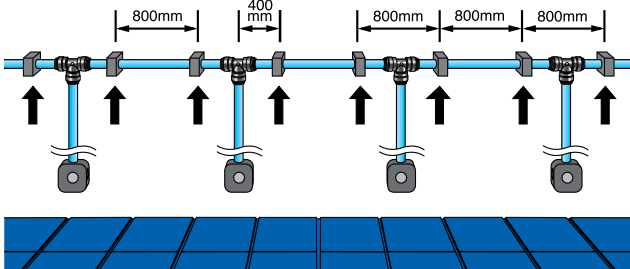

#### Phase 2: System with pressure

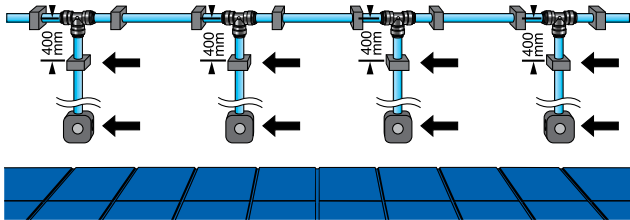

**Note:** All compressed air systems should be equipped with an air line water trap. We recommend a PMTT22E Water Trap Tee for this purpose.

### Column or Pillar Installation

When installing around a column or pillar, maintain a distance of approximately 100mm between the wall and the pipe. Always maintain a distance of 400mm between the fittings and the pipe clip.

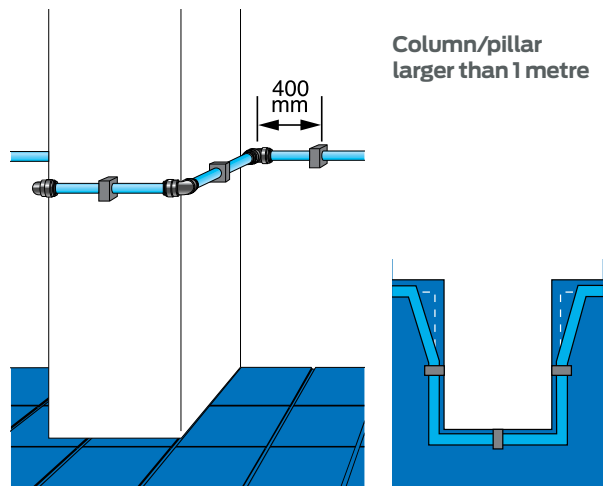
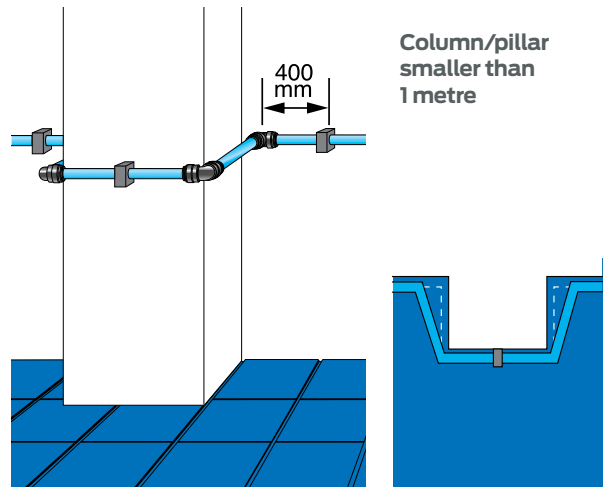

Standard JG Speedfit products can be coupled together to form integral new fittings:

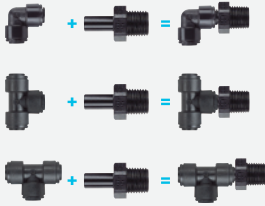

## Black Acetal Fittings – PM Range

### For compressed air and inert gases

The PM Range of metric size fittings is manufactured in black acetal copolymer with food grade nitrile O-Rings. The 12mm to 28mm sizes in the PM range are especially suited to Compressed Air applications. The push-to-connect fittings and pipe means a compressed air system can be installed quickly and easily, with significantly reduced production down time. It is also easy to rearrange and extend a system.

Temperature	Pressure	Temperature	Pressure
AIR/VACUUM	12mm - 28mm	POTABLE LIQUIDS	12mm - 28mm
-20°C	1000kPa	NOT SUITABLE	
+1°C	1000kPa		
+20°C	1000kPa		
+65°C*	700kPa		

\*NOT to exceed maximum temperature



Technical Information  
page 65



### Straight Adaptor – BSP Thread

Product Code	Tube OD	Thread BSP	Pack Size	List Price
PM011213E	12mm	3/8"	10	8.01
PM011214E	12mm	1/2"	10	8.77
PM011514E	15mm	1/2"	1	9.16
PM011516E*	15mm	3/4"	1	10.22
PM011814E	18mm	1/2"	1	9.69
PM012216E	22mm	3/4"	1	10.22
PM012818E	28mm	1"	1	15.19

\*No thread seal



### Equal Elbow

Product Code	Tube OD	Pack Size	List Price
PM0312E	12mm	10	9.12
PM0315E	15mm	1	10.17
PM0318E	18mm	1	11.96
PM0322E	22mm	1	14.24
PM0328E	28mm	1	26.03

**Equal Straight Connector**

Product Code	Tube OD	Pack Size	List Price
PM0412E	12mm	10	6.92
PM0415E	15mm	1	7.42
PM0418E	18mm	1	8.24
PM0422E	22mm	1	10.37
PM0428E	28mm	1	21.60

**Equal Tee**

Product Code	Tube OD	Pack Size	List Price
PM0212E	12mm	10	9.66
PM0215E	15mm	1	13.39
PM0218E	18mm	1	13.73
PM0222E	22mm	1	15.07
PM0228E	28mm	1	33.08

**Reducing Tee**

Product Code	Tube OD Ends	Tube OD Branch	Pack Size	List Price
PM3018AE	18mm	15mm	1	16.21
PM3022AE	22mm	15mm	1	16.21

**Stem Adaptor – BSP Thread**

Product Code	Stem OD	Thread BSP	Pack Size	List Price
PM051213E	12mm	3/8"	10	3.03
PM051214E	12mm	1/2"	10	4.39
PM051513E	15mm	3/8"	1	4.02
PM051514E	15mm	1/2"	1	5.95
PM051814E	18mm	1/2"	1	5.95
PM052214E	22mm	1/2"	1	6.33
PM052216E	22mm	3/4"	1	7.44

**Stem Elbow**

Product Code	Tube OD	Stem OD	Pack Size	List Price
PM221212E	12mm	12mm	10	9.18
PM221515E	15mm	15mm	1	9.00
PM221818E	18mm	18mm	1	14.42
PM222222E	22mm	22mm	1	14.62





## Reducer

Product Code	Stem OD	Tube OD	Pack Size	List Price
PM061512E	15mm	12mm	1	8.81
PM061815E	18mm	15mm	1	9.31
PM062215E	22mm	15mm	1	10.35
PM062218E	22mm	18mm	1	10.35
PM062815E	28mm	15mm	1	16.74
PM062822E	28mm	22mm	1	19.77



## Water Trap Tee

Product Code	Tube OD	Pack Size	List Price
PMTT22E	22mm	1	25.61



## Porting Block

Product Code	Thread BSP	Pack Size	List Price
JG-L-WSK	1/2"	1	50.72

Blanking plugs included.



## U-Bend

Product Code	Tube OD	Pack Size	List Price
PMUB15E	15mm	1	11.40



## End Stop

Product Code	Tube OD	Pack Size	List Price
PM4612E	12mm	10	6.49
PM4615E	15mm	1	7.20
PM4622E	22mm	1	8.37



## Plug

Product Code	Colour	Stem OD	Pack Size	List Price
PM0812R	Red	12mm	10	3.18
PM0815E	Black	15mm	1	3.49
PM0818E	Black	18mm	1	3.65
PM0822E	Black	22mm	1	4.11
PM0828E	Black	28mm	1	5.26



Technical Information  
page 65

## Brass Fittings – MM Range

### For compressed air systems

The MM range of Brass fittings are suitable for compressed air systems. They are intended for use with John Guest nylon, aluminium pipe, or copper, and can also be used on vacuum applications.

Temperature	Pressure	Temperature	Pressure
AIR/VACUUM	15mm - 28mm	POTABLE LIQUIDS	15mm - 28mm
-20°C	1000kPa	<b>NOT SUITABLE</b>	
+1°C	1000kPa		
+20°C	1000kPa		
+65°C*	700kPa		

\*NOT to exceed maximum temperature



### Water Trap Tee Converter

Product Code	Tube OD	Pack Size	List Price
WTC28	28mm	1	17.98

Converts a PM0228E Tee to a Water Trap Tee.



### Brass Wingback Elbow – BSP Thread

Product Code	Tube OD	Thread BSP	Pack Size	List Price
PM15WB	15mm	1/2"	1	30.97
PM22WB	22mm	3/4"	1	46.78



### Straight Male Adaptor – BSPT Thread

Product Code	Tube OD	Thread BSPT	Pack Size	List Price
MM011504N	15mm	1/2"	1	15.95
MM012206N	22mm	3/4"	1	25.96
MM012808N	28mm	1"	1	50.80



### Male Stem Adaptor – BSPT Thread

Product Code	Tube OD	Thread BSPT	Pack Size	List Price
MM051504N	15mm	1/2"	1	14.49
MM052206N	22mm	3/4"	1	24.58
MM052818N	28mm	1"	1	43.23

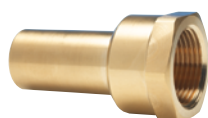

### Female Stem Adaptor – BSPT Thread

Product Code	Tube OD	Thread BSPT	Pack Size	List Price
MM501514N	15mm	1/2"	1	16.66
MM502216N	22mm	3/4"	1	28.28

## Brass Fittings – RM Range

### For pneumatic air line applications

The RM range of brass fittings are suitable for pneumatic air line systems. Suitable for plastic and soft metal pipe.

The Straight Male Adaptor, available in 4mm to 12mm sizes, also have SuperThread, a unique thread seal developed by John Guest, to enable male adaptors to be used with a variety of female thread forms. The RM brass fittings with the SuperThread can be used with BSP (Parallel), BSPT (Taper), NPTF, PF and PT metal thread forms. The special polyurethane seal feature, means no sealant is needed to make an airtight joint. There is no danger of tape entering the system.

Temperature	Pressure	Temperature	Pressure
<b>AIR/VACUUM</b>	<b>4mm - 12mm</b>	<b>POTABLE LIQUIDS</b>	<b>4mm - 12mm</b>
-20°C	1000kPa	<b>Not Suitable</b>	
+1°C	1000kPa		
+20°C	1000kPa		
+65°C*	700kPa		

\*NOT to exceed maximum temperature

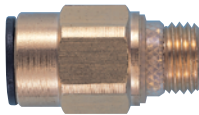

### Straight Male Adaptor – SuperThread

Order Code	Tube OD	SuperThread	Pack Size	List Price
RM010411	4mm	1/8"	10	3.63
RM010412	4mm	1/4"	10	4.54
RM010511	5mm	1/8"	10	4.09
RM010611	6mm	1/8"	10	4.39
RM010612	6mm	1/4"	10	4.39
RM010811	8mm	1/8"	10	4.54
RM010812	8mm	1/4"	10	8.90
RM010813	8mm	3/8"	10	6.55
RM011012	10mm	1/4"	10	7.62
RM011013	10mm	3/8"	10	8.80
RM011014	10mm	1/2"	10	10.96
RM011213	12mm	3/8"	10	10.96
RM011214	12mm	1/2"	10	11.56

Superthread suits BSP, BSPT, NPT, PF and PT.

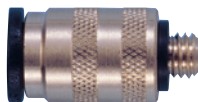

### Straight Male Adaptor – Metric Thread

Order Code	Tube OD	Metric Thread	Pack Size	List Price
RM0104M5	3mm	M5	10	3.90
RM0106M5	6mm	M5	10	4.39



## Speedline Pipe and Accessories

John Guest Compressed Air fittings are intended for use with John Guest rigid nylon pipe.

Collets can be secured into position using a Locking Clip, preventing accidental disconnection, as shown in the image on the left. The Collet Cover is easily removed when required, and comes in the following colours;

### Colours available and suffix indication

E = Black      B = Blue      R = Red



### Speedline Rigid Nylon Pipe

Product Code	Tube OD	Length	List Price
PA-RM1512-3M-20B	15mm	3m	13.37
PA-RM1814-3M-20B	18mm	3m	19.59
PA-RM2218-3M-20B	22mm	3m	23.22
PA-RM2218-5M-20B	22mm	5m	38.72
PA-RM2823-3M-10B	28mm	3m	37.08
PA-RM2823-5M-10B	28mm	5m	61.79



### Collet Covers

Product Code	Tube OD	Colour	Pack Size	List Price
PM1915E	15mm	Black	10	0.71
PM1915B	15mm	Blue	10	0.36
PM1915R	15mm	Red	10	0.36
PM1918E	18mm	Black	10	0.71
PM1922E	22mm	Black	10	0.74
PM1922R	22mm	Red	10	0.43

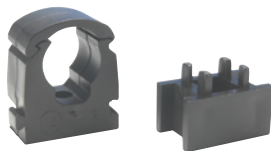

### Pipe Mounting Clip and Spacer

Product Code	Tube OD	Pack Size	List Price
PC15E	15mm	200	1.16
PC18E	18mm	150	1.16
PC22E	22mm	100	1.16
PC28E	28mm	80	1.16
PCSE	Spacer All Sizes	400	1.16



### Pipe Cutter

Product Code	Pack Size	List Price
JG-TS	Suitable for up to 22mm pipe	1      73.73



 1800 810 803

 [sales.au@rwc.com](mailto:sales.au@rwc.com)

 [johnguest.com](http://johnguest.com)

**AN RWC BRAND**  
**RWC** Reliance Worldwide Corporation (Aust.) Pty. Ltd.  
27-28 Chapman Place, Eagle Farm QLD 4009,  
Australia | ABN 71 004 784 301

AU-JG-PG0201-1122-R1

The RWC logo, consisting of the letters 'RWC' in a bold, black, sans-serif font, positioned on a white background that is part of a larger graphic design with blue and yellow geometric shapes.