

SMART Digital S - DDA

up to 30 l/h

Installation and operating instructions



Further languages

<http://net.grundfos.com/qr/i/95724708>

be
think
innovate

GRUNDFOS 

English (GB) Installation and operating instructions

Original installation and operating instructions

CONTENTS

	Page		Page
1. Safety instructions	3	6.5	Analog output 26
1.1 Symbols used in this document	3	6.6	SlowMode 27
1.2 Qualification and training of personnel	3	6.7	FlowControl 28
1.3 Safety instructions for the operator/user	3	6.8	Pressure monitoring 29
1.4 Safety of the system in the event of a failure in the dosing pump	3	6.8.1	Pressure setting ranges 29
1.5 Dosing chemicals	4	6.8.2	Calibration of pressure sensor 29
1.6 Diaphragm breakage	4	6.9	Flow measurement 30
2. General information	5	6.10	AutoFlowAdapt 30
2.1 Applications	5	6.11	Auto deaeration 30
2.2 Improper operating methods	5	6.12	Key lock 30
2.3 Symbols on the pump	6	6.12.1	Temporary deactivation 30
2.4 Nameplate	6	6.12.2	Deactivation 30
2.5 Type key	7	6.13	Display Setup 31
2.6 Product overview	8	6.13.1	Units 31
3. Technical data / Dimensions	9	6.13.2	Additional display 31
3.1 Technical data	9	6.14	Time+date 31
3.2 Technical data for CIP (Clean-In-Place) applications	11	6.15	Bus communication 32
3.3 Dimensions	11	6.15.1	GENbus communication 32
4. Assembly and installation	12	6.15.2	Possible industrial bus types 32
4.1 Pump assembly	12	6.15.3	Activate communication 32
4.1.1 Requirements	12	6.15.4	Setting the bus address 32
4.1.2 Align and install mounting plate	12	6.15.5	Characteristics of bus communication 33
4.1.3 Engage pump in mounting plate	12	6.15.6	Deactivate communication 33
4.1.4 Adjusting control cube position	12	6.15.7	Communication faults 33
4.2 Hydraulic connection	13	6.16	Inputs/Outputs 34
4.3 Electrical connection	14	6.16.1	Relay outputs 34
5. Startup	16	6.16.2	External stop 35
5.1 Setting the menu language	16	6.16.3	Empty and Low level signals 35
5.2 Deaerating the pump	17	6.17	Basic settings 35
5.3 Calibrating the pump	17	7. Service	36
6. Operation	19	7.1	Regular maintenance 36
6.1 Control elements	19	7.2	Cleaning 36
6.2 Display and symbols	19	7.3	Service system 36
6.2.1 Navigation	19	7.4	Perform service 37
6.2.2 Operating states	19	7.4.1	Dosing head overview 37
6.2.3 Sleep mode (energy-saving mode)	19	7.4.2	Dismantling the diaphragm and valves 37
6.2.4 Overview of display symbols	20	7.4.3	Reassembling the diaphragm and valves 38
6.3 Main menus	21	7.5	Resetting the service system 38
6.3.1 Operation	21	7.6	Diaphragm breakage 38
6.3.2 Info	21	7.6.1	Dismantling in case of diaphragm breakage 39
6.3.3 Alarm	21	7.6.2	Dosing liquid in the pump housing 39
6.3.4 Setup	21	7.7	Repairs 39
6.4 Operation modes	22	8. Faults	40
6.4.1 Manual	22	8.1	List of faults 41
6.4.2 Pulse	22	8.1.1	Faults with error message 41
6.4.3 Analog 0/4-20 mA	23	8.1.2	General faults 43
6.4.4 Batch (pulse-based)	24	9. Disposal	43
6.4.5 Dosing timer cycle	25		
6.4.6 Dosing timer week	25		



Warning

Prior to installation, read these installation and operating instructions. Installation and operation must comply with local regulations and accepted codes of good practice.

1. Safety instructions

These installation and operating instructions contain general instructions that must be observed during installation, operation and maintenance of the pump. It must therefore be read by the installation engineer and the relevant qualified operator prior to installation and start-up, and must be available at the installation location at all times.

1.1 Symbols used in this document



Warning

If these safety instructions are not observed, it may result in personal injury.

Caution

If these safety instructions are not observed, it may result in malfunction or damage to the equipment.

Note

Notes or instructions that make the job easier and ensure safe operation.

1.2 Qualification and training of personnel

The personnel responsible for the installation, operation and service must be appropriately qualified for these tasks. Areas of responsibility, levels of authority and the supervision of the personnel must be precisely defined by the operator. If necessary, the personnel must be trained appropriately.

Risks of not observing the safety instructions

Non-observance of the safety instructions may have dangerous consequences for the personnel, the environment and the pump and may result in the loss of any claims for damages.

It may lead to the following hazards:

- Personal injury from exposure to electrical, mechanical and chemical influences.
- Damage to the environment and personal injury from leakage of harmful substances.

1.3 Safety instructions for the operator/user

The safety instructions described in these instructions, existing national regulations on health protection, environmental protection and for accident prevention and any internal working, operating and safety regulations of the operator must be observed. Information attached to the pump must be observed. Leakages of dangerous substances must be disposed of in a way that is not harmful to the personnel or the environment.

Damage caused by electrical energy must be prevented, see the regulations of the local electricity supply company.

Caution

Before any work to the pump, the pump must be in the "Stop" operating state or be disconnected from the power supply. The system must be pressureless!

Note

The mains plug is the separator separating the pump from the mains.

Only original accessories and original spare parts should be used. Using other parts can result in exemption from liability for any resulting consequences.

1.4 Safety of the system in the event of a failure in the dosing pump

The dosing pump was designed according to the latest technologies and is carefully manufactured and tested.

If it fails regardless of this, the safety of the overall system must be ensured. Use the relevant monitoring and control functions for this.

Caution

Make sure that any chemicals that are released from the pump or any damaged lines do not cause damage to system parts and buildings.

The installation of leak monitoring solutions and drip trays is recommended.

1.5 Dosing chemicals

Warning



Before switching the supply voltage back on, the dosing lines must be connected in such a way that any chemicals in the dosing head cannot spray out and put people at risk.

The dosing medium is pressurised and can be harmful to health and the environment.

Warning



When working with chemicals, the accident prevention regulations applicable at the installation site should be applied (e.g. wearing protective clothing).

Observe the chemical manufacturer's safety data sheets and safety instructions when handling chemicals!

Caution

A deaeration hose, which is routed into a container, e.g. a drip tray, must be connected to the deaeration valve.

Caution

The dosing medium must be in liquid aggregate state!

Observe the freezing and boiling points of the dosing medium!

The resistance of the parts that come into contact with the dosing medium, such as the dosing head, valve ball, gaskets and lines, depends on the medium, media temperature and operating pressure.

Caution

Ensure that parts in contact with the dosing media are resistant to the dosing medium under operating conditions, see data booklet!

Should you have any questions regarding the material resistance and suitability of the pump for specific dosing media, please contact Grundfos.

1.6 Diaphragm breakage

If the diaphragm leaks or is broken, dosing liquid escapes from the drain opening (fig. 41, pos. 11) on the dosing head. Observe section [7.6 Diaphragm breakage](#).

Warning

Danger of explosion, if dosing liquid has entered the pump housing!

Operation with damaged diaphragm can lead to dosing liquid entering the pump housing.



In case of diaphragm breakage, immediately separate the pump from the power supply!

Make sure the pump cannot be put back into operation by accident!

Dismantle the dosing head without connecting the pump to the power supply and make sure no dosing liquid has entered the pump housing. Proceed as described in section [7.6.1 Dismantling in case of diaphragm breakage](#).

To avoid any danger resulting from diaphragm breakage, observe the following:

- Perform regular maintenance. See section [7.1 Regular maintenance](#).
- Never operate the pump with blocked or soiled drain opening.
 - If the drain opening is blocked or soiled, proceed as described in section [7.6.1 Dismantling in case of diaphragm breakage](#).
- Never attach a hose to the drain opening. If a hose is attached to the drain opening, it is impossible to recognise escaping dosing liquid.
- Take suitable precautions to prevent harm to health and damage to property from escaping dosing liquid.
- Never operate the pump with damaged or loose dosing head screws.

2. General information



The DDA dosing pump is a self-priming diaphragm pump. It consists of a housing with stepper motor and electronics, a dosing head with diaphragm and valves and the control cube.

Excellent dosing features of the pump:

- Optimal intake even with degassing media, as the pump always works at full suction stroke volume.
- Continuous dosing, as the medium is sucked up with a short suction stroke, regardless of the current dosing flow, and dosed with the longest possible dosing stroke.

2.1 Applications

The pump is suitable for liquid, non-abrasive, non-flammable and non-combustible media strictly in accordance with the instructions in these installation and operating instructions.

Areas of application

- Drinking water treatment
- Wastewater treatment
- Swimming pool water treatment
- Boiler water treatment
- CIP (Clean-In-Place) Observe section [3.2 Technical data for CIP \(Clean-In-Place\) applications](#).
- Cooling water treatment
- Process water treatment
- Wash plants
- Chemical industry
- Ultrafiltration processes and reverse osmosis
- Irrigation
- Paper and pulp industry
- Food and beverage industries

2.2 Improper operating methods

The operational safety of the pump is only guaranteed if it is used in accordance with section [2.1 Applications](#).

Warning



Other applications or the operation of pumps in ambient and operating conditions, which are not approved, are considered improper and are not permitted. Grundfos cannot be held liable for any damage resulting from incorrect use.



Warning

The pump is NOT approved for operation in potentially explosive areas!



Warning

A sunscreen is required for outdoor installation!







Frequent disengagement from the mains voltage, e.g. via a relay, can result in damage to the pump electronics and in the breakdown of the pump. The dosing accuracy is also reduced as a result of internal start procedures.

Do not control the pump via the mains voltage for dosing purposes!

Only use the "External stop" function to start and stop the pump!

2.3 Symbols on the pump

Symbol	Description
	Indication of universally dangerous spot.
	In case of emergency and prior to all maintenance work and repairs, take the mains plug out of the mains supply!
	The device complies with electrical safety class II.
	Connection for deaeration hose at dosing head. If the deaeration hose is not correctly connected, danger will arise due to possible leakage of dosing liquid!

2.4 Nameplate

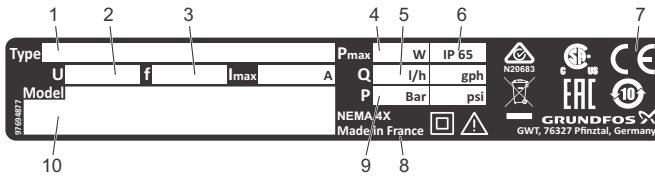

Fig. 1 Nameplate

Pos.	Description	Pos.	Description
1	Type designation	6	Enclosure class
2	Voltage	7	Mark of approval, CE mark, etc.
3	Frequency	8	Country of origin
4	Power consumption	9	Max. operating pressure
5	Max. dosing flow	10	Model

TM04 8144 1720

2.5 Type key

The type key is used to identify the precise pump and is not used for configuration purposes.

Code	Example	DDA	7.5-	16	AR-	PP/	V/	C-	F-	3	1	U2U2	F	G
	Pump type													
	Max. flow [l/h]													
	Max. pressure [bar]													
	Control variant													
AR	Standard													
FC	AR with FlowControl													
FCM	FC with integrated flow measurement													
	Dosing head material													
PP	Polypropylene													
PVC	PVC (polyvinyl chloride, only up to 10 bar)													
PV	PVDF (polyvinylidene fluoride)													
SS	Stainless steel DIN 1.4401													
	Gasket material													
E	EPDM													
V	FKM													
T	PTFE													
	Valve ball material													
C	Ceramic													
SS	Stainless steel DIN 1.4401													
	Control cube position													
F	Front-mounted (can be changed to the right or left)													
	Voltage													
3	1 x 100-240 V, 50/60 Hz													
	Valve type													
1	Standard													
2	Spring-loaded (HV version)													
	Suction/discharge side connection													
U2U2	Hose, 4/6 mm, 6/9 mm, 6/12 mm, 9/12 mm													
U7U7	Hose 0.17" x 1/4"; 1/4" x 3/8"; 3/8" x 1/2"													
AA	Threaded Rp 1/4, female (stainless steel)													
VV	Threaded 1/4 NPT, female (stainless steel)													
XX	No connection													
	Installation set*													
I001	Hose, 4/6 mm (up to 7.5 l/h, 13 bar)													
I002	Hose, 9/12 mm (up to 60 l/h, 9 bar)													
I003	Hose, 0.17" x 1/4" (up to 7.5 l/h, 13 bar)													
I004	Hose, 3/8" x 1/2" (up to 60 l/h, 10 bar)													
	Mains plug													
F	EU													
B	USA, Canada													
G	UK													
I	Australia, New Zealand, Taiwan													
E	Switzerland													
J	Japan													
L	Argentina													
	Design													
G	Grundfos													

* including: 2 pump connections, foot valve, injection unit, 6 m PE discharge hose, 2 m PVC suction hose, 2 m PVC deaeration hose (4/6 mm)

2.6 Product overview

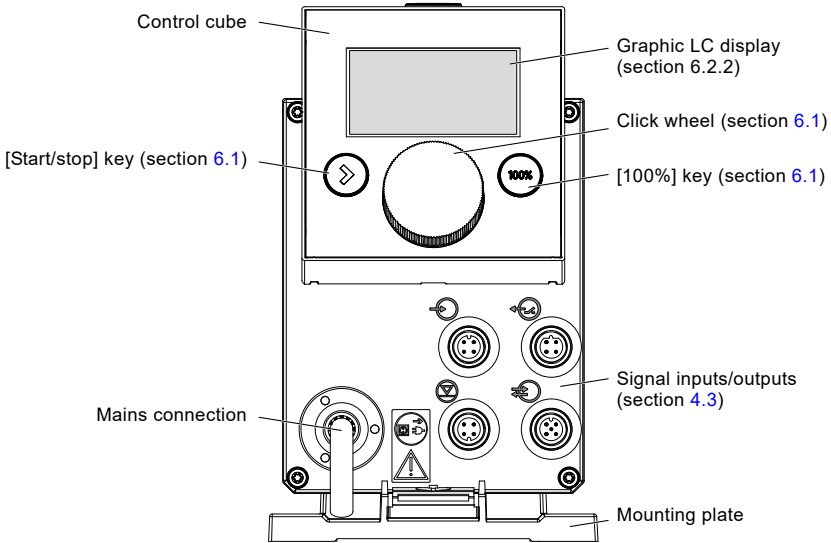

Fig. 2 Front view of the pump

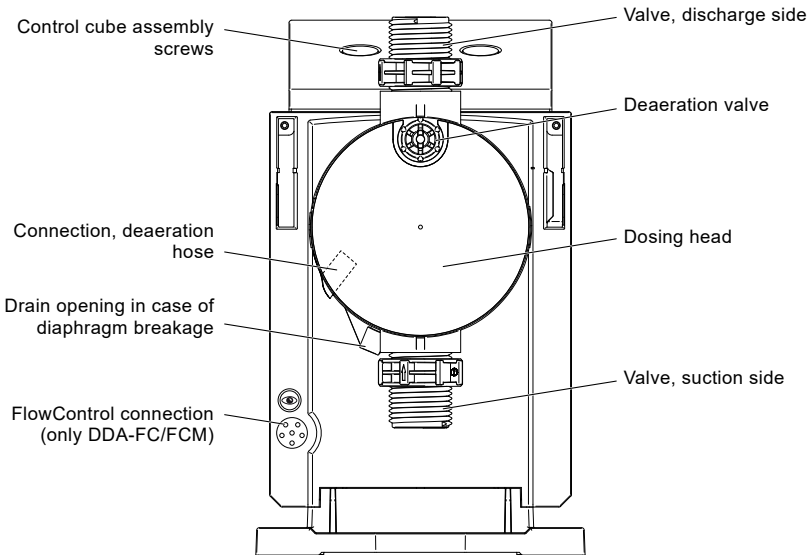

Fig. 3 Rear view of the pump

TM04 1129 3117

TM04 1129 3117

3. Technical data / Dimensions



3.1 Technical data

Data		7.5-16	12-10	17-7	30-4	
Mechanical data	Turn-down ratio (setting range)	[1:X]	3000	1000	1000	1000
	Max. dosing capacity	[l/h]	7.5	12.0	17.0	30.0
		[gph]	2.0	3.1	4.5	8.0
	Max. dosing capacity with SlowMode 50 %	[l/h]	3.75	6.00	8.50	15.00
		[gph]	1.00	1.55	2.25	4.00
	Max. dosing capacity with SlowMode 25 %	[l/h]	1.88	3.00	4.25	7.50
		[gph]	0.50	0.78	1.13	2.00
	Min. dosing capacity	[l/h]	0.0025	0.0120	0.0170	0.0300
		[gph]	0.0007	0.0031	0.0045	0.0080
	Max. operating pressure ⁶⁾	[bar]	16	10	7	4
		[psi]	230	150	100	60
	Max. stroke frequency ¹⁾	[strokes/min]	190	155	205	180
	Stroke volume	[ml]	0.74	1.45	1.55	3.10
	Accuracy of repeatability	[%]	± 1			
	Max. suction lift during operation ²⁾	[m]	6			
	Max. suction lift when priming with wet valves ²⁾	[m]	2	3	3	2
	Min. pressure difference between suction and discharge side	[bar]	1 (FC and FCM: 2)			
	Max. inlet pressure, suction side	[bar]	2			
	Max. viscosity in SlowMode 25 % with spring-loaded valves ³⁾	[mPas] (= cP)	2500	2500	2000	1500
	Max. viscosity in SlowMode 50 % with spring-loaded valves ³⁾	[mPas] (= cP)	1800	1300	1300	600
Max. viscosity without SlowMode with spring-loaded valves ³⁾	[mPas] (= cP)	600	500	500	200	
Max. viscosity without spring-loaded valves ³⁾	[mPas] (= cP)	50	300	300	150	
Min. internal hose/pipe diameter suction/discharge side ^{2), 4)}	[mm]	4	6	6	9	
Min. internal hose/pipe diameter suction/discharge side (high viscosity) ⁴⁾	[mm]	9				
Min./Max. liquid temperature	[°C]	-10/45				
Min./Max. ambient temperature	[°C]	0/45				
Min./Max. storage temperature	[°C]	-20/70				
Max. relative humidity (non-condensing)	[%]	96				
Max. altitude above sea level	[m]	2000				

Data		7.5-16	12-10	17-7	30-4
Electrical data	Voltage [V]	100-240 V, - 10 %/+ 10 %, 50/60 Hz			
	Length of mains cable [m]	1.5			
	Max. inrush current for 2 ms (100 V) [A]	8			
	Max. inrush current for 2 ms (230 V) [A]	25			
	Max. power consumption P ₁ [W]	24 ⁵⁾			
	Enclosure class	IP65, Nema 4X			
	Electrical safety class	II			
	Pollution degree	2			
Signal input	Max. load for level input	12 V, 5 mA			
	Max. load for pulse input	12 V, 5 mA			
	Max. load for External stop input	12 V, 5 mA			
	Min. pulse length [ms]	5			
	Max. pulse frequency [Hz]	100			
	Impedance at 0/4-20 mA analog input [Ω]	15			
	Accuracy of analog input (full-scale value) [%]	± 1.5			
	Min. resolution of analog input [mA]	0.05			
Signal output	Max. resistance in level/pulse circuit [Ω]	1000			
	Max. ohmic load on relay output [A]	0.5			
	Max. voltage on relay/analog output [V]	30 VDC/30 VAC			
	Impedance at 0/4-20 mA analog output [Ω]	500			
	Accuracy of analog output (full-scale value) [%]	± 1.5			
	Min. resolution of analog output [mA]	0.02			
Weight/size	Weight (PVC, PP, PVDF) [kg]	2.4	2.4	2.6	
	Weight (stainless steel) [kg]	3.2	3.2	4.0	
	Diaphragm diameter [mm]	44	50	74	
Sound pressure	Max. sound pressure level [dB(A)]	60			
Approvals		CE, CB, CSA-US, NSF61, EAC, ACS, RCM			

- 1) The maximum stroke frequency varies depending on calibration
- 2) Data is based on measurements with water
- 3) Maximum suction lift: 1 m, dosing capacity reduced (approx. 30 %)
- 4) Length of suction line: 1.5 m, length of discharge line: 10 m (at max. viscosity)
- 5) With E-Box
- 6) PVC (polyvinyl chloride), only up to 10 bar

3.2 Technical data for CIP (Clean-In-Place) applications

Short-term temperature limits for max. 40 minutes at max. 2 bar operating pressure:

Max. liquid temperature for dosing head material PVDF	[°C]	85
Max. liquid temperature for dosing head material stainless steel	[°C]	120



The dosing head material Polyvinyl chloride (PVC) must not be used in CIP applications.

3.3 Dimensions

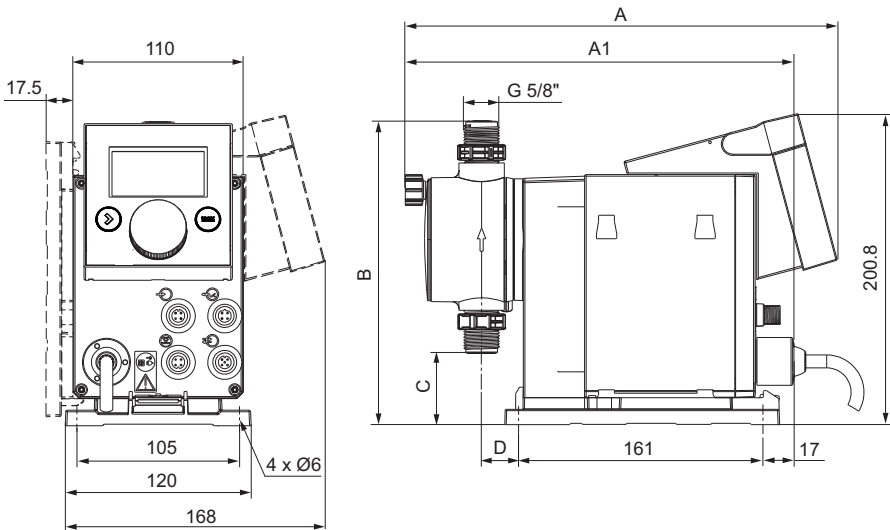

TM04 1103 3117

Fig. 4 Dimensional sketch

Pump type	A [mm]	A1 [mm]	B [mm]	C [mm]	D [mm]
DDA 7.5-16	280	251	196	46.5	24
DDA 12-10/17-7	280	251	200.5	39.5	24
DDA 30-4	295	267	204.5	35.5	38.5

4. Assembly and installation

For use in Australia:

Installation of this product must comply with AS/NZS3500!

Note

Certificate of suitability number: CS9431
RCM number: N20683



4.1 Pump assembly

Warning



Install the pump in such a way that the plug can easily be reached by the operator during operation! This will enable the operator to separate the pump from the mains quickly in case of emergency!

The pump is delivered with a mounting plate. The mounting plate can be mounted vertically e.g. on a wall or horizontally e.g. on a tank. It takes just a few quick steps to firmly secure the pump to the mounting plate by means of a slot mechanism.

The pump can easily be released from the mounting plate for maintenance.

4.1.1 Requirements

- The mounting surface must be stable and must not vibrate.
- Dosing must flow upwards vertically.

4.1.2 Align and install mounting plate

- **Vertical installation:** Mounting plate slot mechanism must be above.
- **Horizontal installation:** Mounting plate slot mechanism must be opposite the dosing head.
- The mounting plate can be used as a drill template, please see fig. 4 for drill hole distances.

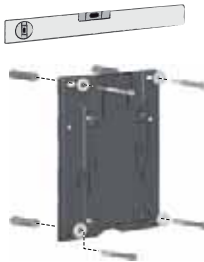

Fig. 5 Locate mounting plate



Warning

Make sure that you do not damage any cables and lines during installation!

1. Indicate drill holes.
2. Drill holes.
3. Secure mounting plate using four screws, diameter 5 mm, to the wall, on the bracket or the tank.

4.1.3 Engage pump in mounting plate

1. Attach the pump to the mounting plate support clamps and slide under slight pressure until it engages.

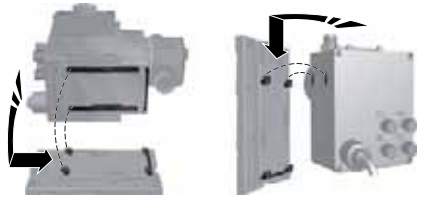

Fig. 6 Engaging the pump

4.1.4 Adjusting control cube position

The control cube is fitted to the front of the pump on delivery. It can be turned by 90 ° so that the user can select to operate the pump from the right or left side.

Caution

The enclosure class (IP65/Nema 4X) and shock protection are only guaranteed if the control cube is installed correctly!

Caution

Pump must be disconnected from the power supply!

1. Carefully remove both protective caps on the control cube using a thin screwdriver.
2. Loosen screws.
3. Carefully lift off control cube only so far from the pump housing that no tensile stress is produced on the flat band cable.
4. Turn control cube by 90 ° and re-attach.
 - Make sure the O-ring is secure.
5. Tighten screws slightly and attach protective caps.

TM04 1162-0110

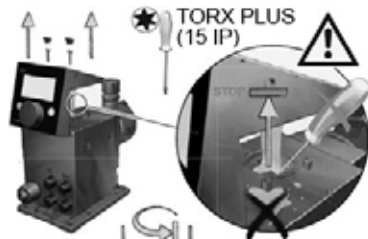

IP65, Nema 4X



Fig. 7 Adjusting control cube

TM04 1159 0110

TM04 1182 3117

4.2 Hydraulic connection



Warning

Risk of chemical burns!

Wear protective clothing (gloves and goggles) when working on the dosing head, connections or lines!

The dosing head may contain water from the factory check!

Caution

When dosing media which should not come into contact with water, another medium must be dosed beforehand!

Caution

Faultless function can only be guaranteed in conjunction with lines supplied by Grundfos!

Caution

The lines used must comply with the pressure limits as per section [3.1 Technical data!](#)

Important information on installation

- Observe suction lift and line diameter, see section [3.1 Technical data](#).
- Shorten hoses at right angles.
- Ensure that there are no loops or kinks in the hoses.
- Keep suction line as short as possible.
- Route suction line up towards the suction valve.
- Installing a filter in the suction line protects the entire installation against dirt and reduces the risk of leakage.
- Only control variant FC/FCM: For discharge quantities < 1 l/h we recommend the use of an additional spring-loaded valve (approx. 3 bar) on the discharge side for the safe generation of the necessary differential pressure.

Hose connection procedure

1. Push union nut and tensioning ring across hose.
2. Push cone part fully into hose, see [fig. 8](#).
3. Attach cone part with hose to corresponding pump valve.
4. Tighten union nut manually.
 - Do not use tools!
5. Tighten up union nuts after 2-5 operating hours if using PTFE gaskets!
6. Attach deaeration hose to the corresponding connection (see [fig. 3](#)) and run into a container or a collecting tray.

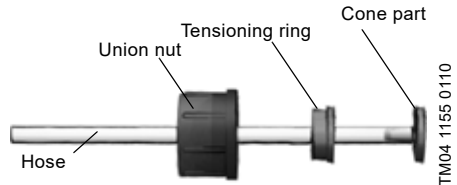

Fig. 8 Hydraulic connection

Note

Pressure differential between suction and discharge side must be at least 1 bar/14.5 psi!

Caution

Tighten the dosing head screws with a torque wrench once before commissioning and again after 2-5 operating hours at 4 Nm.

Installation example

The pump offers various installation options. In the picture below, the pump is installed in conjunction with a suction line, level switch and multifunction valve on a Grundfos tank.

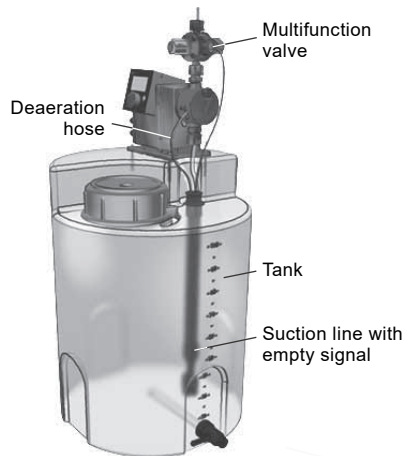

Fig. 9 Installation example

4.3 Electrical connection



Warning
The enclosure class (IP65/Nema 4X) is only guaranteed if plugs or protective caps are correctly installed!



Warning
The pump can start automatically when the mains voltage is switched on!
Do not manipulate mains plug or cable!

The mains plug is the separator separating the pump from the mains.



Note The rated voltage of the pump, see section [2.4 Nameplate](#), must conform to local conditions.

Signal connections



Warning
Electric circuits of external devices connected to the pump inputs must be separated from dangerous voltage by means of double or reinforced insulation!

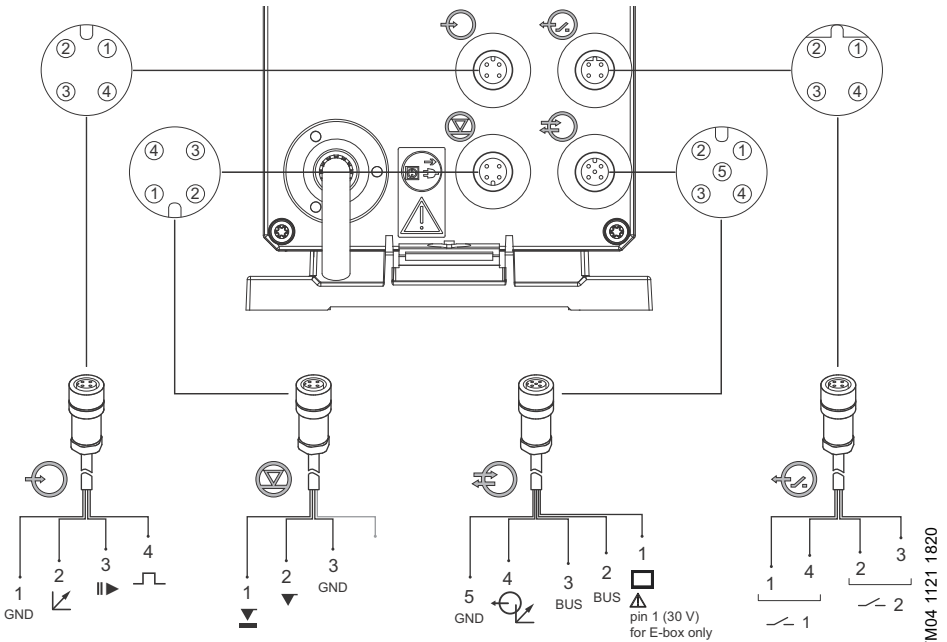

TM04 1121 1820

Fig. 10 Wiring diagram of the electrical connections

Analog, External stop and pulse input

Function	Pins			
	1/brown	2/white	3/blue	4/black
Analog	GND/(-) mA	(+) mA		
External stop	GND		X	
Pulse	GND			X

Level signals: Empty signal and Low-level signal

Function	Pins			
	1	2	3	4
Low-level signal	X		GND	
Empty signal		X	GND	

GENibus, Analog output

Danger of damage to the product due to short circuit! Pin 1 supplies 30 VDC.
 Never short-circuit pin 1 with any of the other pins!

Caution

Function	Pins				
	1/brown	2/white	3/blue	4/black	5/yellow/green
GENibus	+30 V	RS-485 A	RS-485 B		GND
Analog output				(+) mA	GND/(-) mA

Relay outputs

Function	Pins			
	1/brown	2/white	3/blue	4/black
Relay 1	X			X
Relay 2		X	X	

FlowControl signal connection

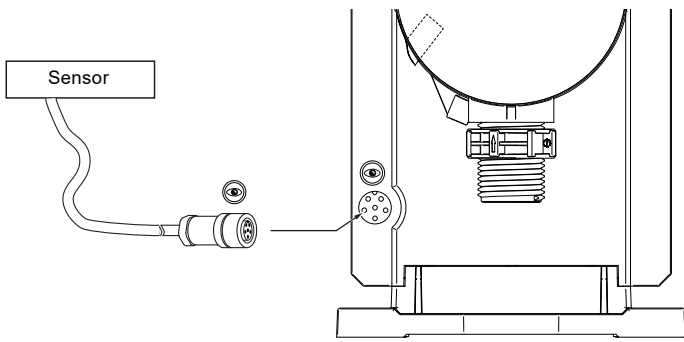

Fig. 11 FlowControl signal connection

TM04 1158 1716

5. Startup

5.1 Setting the menu language

For description of control elements, see section 6.

1. Turn click wheel to highlight the cog symbol.

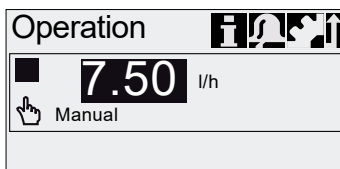

2. Press the click wheel to open the "Setup" menu.

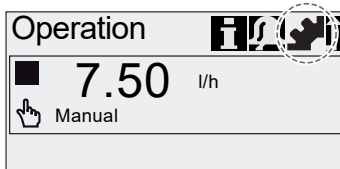

3. Turn the click wheel to highlight the "Language" menu.

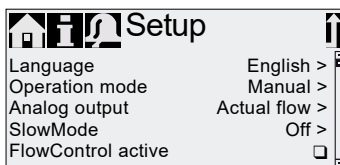

4. Press the click wheel to open the "Language" menu.

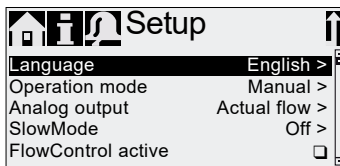

5. Turn the click wheel to highlight the desired language.

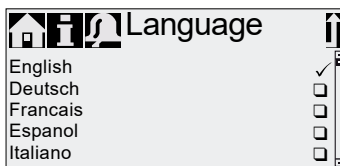

6. Press the click wheel to select the highlighted language.

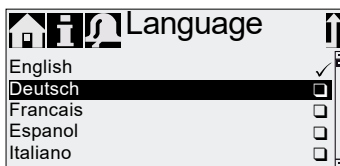

7. Press the click wheel again to confirm the "Confirm settings?" prompt and apply the setting.



Fig. 12 Set menu language



5.2 Deaerating the pump



Warning

The deaeration hose must be connected correctly and inserted into a suitable tank!

1. Open deaeration valve by approximately half a turn.
2. Press and hold down the [100%] key (deaeration key) until liquid flows continuously without any bubbles from the deaeration hose.
3. Close deaeration valve.

Press the [100%] key and simultaneously turn the click wheel clockwise to increase the duration of the process to up to 300 seconds. After setting the seconds, do not press the key any longer.

Note

5.3 Calibrating the pump

The pump is calibrated in the factory for media with a viscosity similar to water at maximum pump backpressure (see section [3.1 Technical data](#)).

If the pump is operated with a backpressure that deviates or if dosing a medium whose viscosity deviates, the pump must be calibrated.

For pumps with FCM control variant, it is not necessary to calibrate the pump if there is deviating or fluctuating backpressure as long as the "AutoFlowAdapt" function has been enabled (see section [6.10 AutoFlowAdapt](#)).

Requirements

- The hydraulics and electrics of the pump are connected (see section [4. Assembly and installation](#)).
- The pump is integrated into the dosing process under operating conditions.
- The dosing head and suction hose are filled with dosing medium.
- The pump has been deaerated.

Calibration process - example for DDA 7.5-16

1. Fill a measuring beaker with dosing medium.
Recommended filling volumes V_1 :
 - DDA 7.5-16: 0.3 l
 - DDA 12-10: 0.5 l
 - DDA 17-7: 1.0 l
 - DDA 30-4: 1.5 l

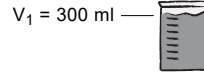

2. Read off and note down the fill volume V_1 (e.g. 300 ml).
3. Place the suction hose in the measuring beaker.

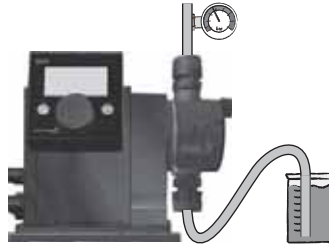

4. Start the calibration process in the "Setup > Calibration" menu.



5. The pump executes 200 dosing strokes and displays the factory calibration value (e.g. 125 ml).



6. Remove the suction hose from the measuring beaker and check the remaining volume V_2 (e.g. 170 ml).

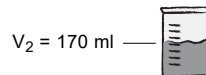

7. From V_1 and V_2 , calculate the actual dosed volume $V_d = V_1 - V_2$ (e.g. 300 ml - 170 ml = 130 ml).

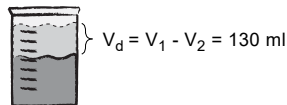

8. Set and apply V_d in the calibration menu.
 - The pump is calibrated.

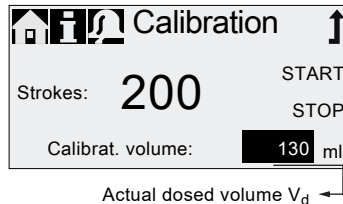

6. Operation



6.1 Control elements

The pump control panel includes a display and the following control elements.

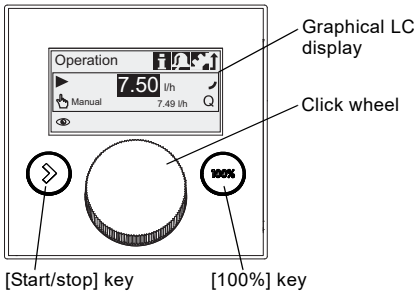

Fig. 13 Control panel

Keys

Key	Function
[Start/stop] key	Starting and stopping the pump.
[100%] key	The pump doses at maximum flow regardless of the operation mode.

Click wheel

The click wheel is used to navigate through the menus, select settings and confirm them.

Turning the click wheel clockwise moves the cursor clockwise in increments in the display. Turning the click wheel counter-clockwise moves the cursor counter-clockwise.

6.2 Display and symbols

6.2.1 Navigation

In the "Info", "Alarm" and "Setup" main menus, the options and submenus are displayed in the rows below. Use the "Back" symbol to return to the higher menu level. The scroll bar at the right edge of the display indicates that there are further menu items which are not shown.

The active symbol (current cursor position) flashes. Press the click wheel to confirm your selection and open the next menu level. The active main menu is displayed as text, the other main menus are displayed as symbols. The position of the cursor is highlighted in black in the sub-menus.

When you position the cursor on a value and press the click wheel, a value is selected. Turning the click wheel clockwise increases the value, turning the click wheel counter-clockwise reduces the value. When you now press the click wheel, the cursor will be released again.

6.2.2 Operating states

The operating state of the pump is indicated by a symbol and display colour.

Display	Fault	Operating state		
White	-	Stop	Standby	
Green	-			Running
Yellow	Warning	Stop	Standby	Running
Red	Alarm	Stop	Standby	

6.2.3 Sleep mode (energy-saving mode)

If in the "Operation" main menu the pump is not operated for 30 seconds, the header disappears. After two minutes, the display brightness is reduced.

If in any other menu the pump is not operated for two minutes, the display switches back to the "Operation" main menu and the display brightness is reduced. This state will be cancelled when the pump is operated or a fault occurs.

TM04 1104 3117

6.2.4 Overview of display symbols

The following display symbols may appear in the menus.

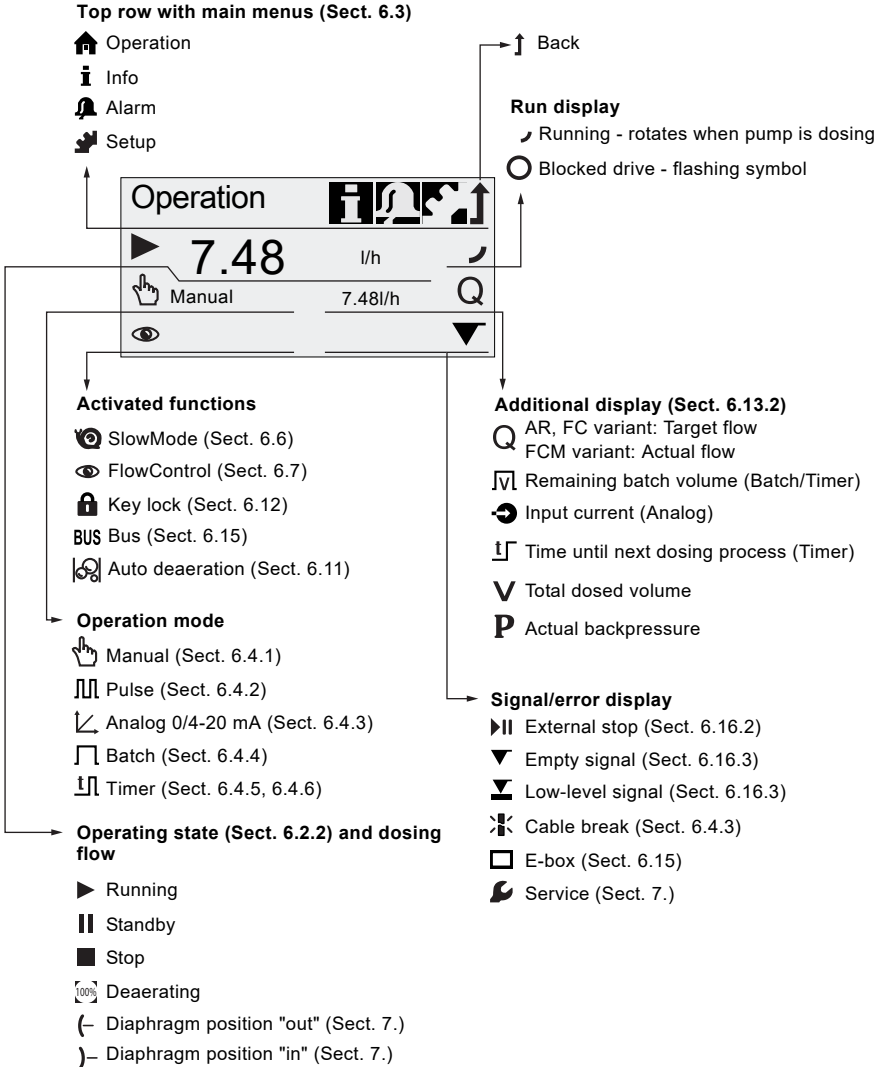

Fig. 14 Overview of display symbols

6.3 Main menus

The main menus are displayed as symbols at the top of the display. The currently active main menu is displayed as text.

6.3.1 Operation

Status information such as the dosing flow, selected operation mode and operating state is displayed in the "Operation" main menu.

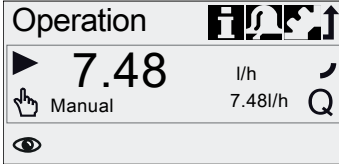

TM04 1157 2011

6.3.2 Info

You can find the date, time and information about the active dosing process, various counters, product data and the service system status in the "Info" main menu. The information can be accessed during operation.

The service system can also be reset from here.

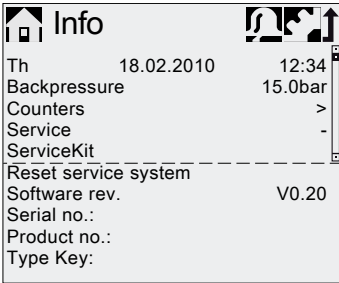

TM04 1106 1010

Counters

The "Info > Counters" menu contains the following counters:

Counters	Resettable
Volume	
Total dosed volume [l] or US gallons	Yes
Operating hours	
Accumulated operating hours (pump switched on) [h]	No
Motor runtime	
Accumulated motor runtime [h]	No
Strokes	
Accumulated number of dosing strokes	No
Power on/off	
Accumulated frequency of switching mains voltage on	No

6.3.3 Alarm

You can view errors in the "Alarm" main menu.

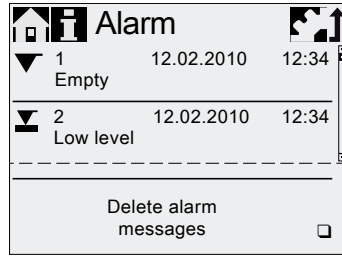

TM04 1109 1010

Up to 10 warnings and alarms, together with their date, time and cause, are listed in chronological order. If the list is full, the oldest entry will be overwritten, see section 8. *Faults*.

6.3.4 Setup

The "Setup" main menu contains menus for pump configuration. These menus are described in the following sections.

Note Check all pump settings after any change in the "Setup" menu.

Setup	Section
Language	English > 5.1
Operation mode	Pulse > 6.4
Pulse memory*	<input type="checkbox"/> > 6.4.2
Analog scaling	> 6.4.3
Batch volume*	1.06 l > 6.4.4
Dosing time[mm:ss]*	7:50 > 6.4.4
Dosing timer cycle*	> 6.4.5
Dosing timer week*	> 6.4.6
Analog output	Actual flow > 6.5
SlowMode	Off > 6.6
FlowControl active*	<input type="checkbox"/> > 6.7
FlowControl*	> 6.7
Pressure monitoring*	> 6.8
AutoFlowAdapt*	<input type="checkbox"/> > 6.10
Auto deaeration	<input type="checkbox"/> > 6.11
Calibration	> 5.3
Key lock	Off > 6.12
Display	> 6.13
Time+date	> 6.14
Bus	> 6.15
Inputs/Outputs	> 6.16
Basic settings	> 6.17

TM04 1110 1010

* These submenus are only displayed for specific default settings and control variants. The contents of the "Setup" menu also vary depending on the operation mode.

6.4 Operation modes

Six different operation modes can be set in the "Setup > Operation mode" menu.

- Manual, see section 6.4.1
- Pulse, see section 6.4.2
- Analog 0-20mA, see section 6.4.3
- Analog 4-20mA, see section 6.4.3
- Batch (pulse-based), see section 6.4.4
- Dosing timer cycle, see section 6.4.5
- Dosing timer week, see section 6.4.6

6.4.1 Manual

In this operation mode, the pump constantly doses the dosing flow set with the click wheel. The dosing flow is set in l/h or ml/h in the "Operation" menu. The pump automatically switches between the units. Alternatively, the display can be reset to US units (gph). See section 6.13 *Display Setup*.

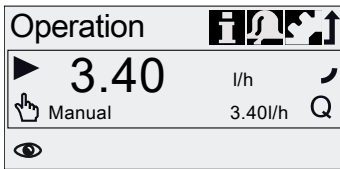

Fig. 15 Manual mode

The setting range depends on the pump type:

Type	Setting range*	
	[l/h]	[gph]
DDA 7.5-16	0.0025 - 7.5	0.0007 - 2.0
DDA 12-10	0.012 - 12	0.0031 - 3.1
DDA 17-7	0.017 - 17	0.0045 - 4.5
DDA 30-4	0.03 - 30	0.0080 - 8.0

* When the "SlowMode" function is active, the maximum dosing flow is reduced, see section 3.1 *Technical data*.

6.4.2 Pulse

In this operation mode, the pump doses the set dosing volume for each incoming (potential-free) pulse, e.g. from a water meter. The pump automatically calculates the optimum stroke frequency for dosing the set volume per pulse.

The calculation is based on:

- the frequency of external pulses
- the set dosing volume/pulse.

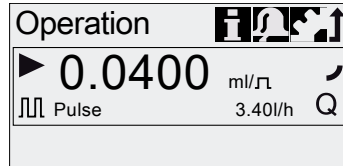

Fig. 16 Pulse mode

The dosing volume per pulse is set in ml/pulse in the "Operation" menu using the click wheel. The setting range for the dosing volume depends on the pump type:

Type	Setting range [ml/pulse]
DDA 7.5-16	0.0015 - 14.9
DDA 12-10	0.0029 - 29.0
DDA 17-7	0.0031 - 31.0
DDA 30-4	0.0062 - 62.0

The frequency of incoming pulses is multiplied by the set dosing volume. If the pump receives more pulses than it can process at the maximum dosing flow, it runs at the maximum stroke frequency in continuous operation. Excess pulses will be ignored if the memory function is not enabled.

Memory function

When the "Setup > Pulse memory" function is enabled, up to 65,000 unprocessed pulses can be saved for subsequent processing.



Warning

Subsequent processing of saved pulses can cause local increase in concentration!

The contents of the memory will be deleted by:

- Switching off the power supply
- Changing the operation mode
- Interruption (e.g. alarm, External stop).



6.4.3 Analog 0/4-20 mA

In this operation mode, the pump doses according to the external analog signal. The dosing volume is proportional to the signal input value in mA.

Operation mode	Input value [mA]	Dosing flow [%]
4-20 mA	≤ 4.1	0
	≥ 19.8	100
0-20 mA	≤ 0.1	0
	≥ 19.8	100

If the input value in operation mode 4-20 mA falls below 2 mA, an alarm is displayed and the pump stops. A cable break or signal transmitter error has occurred. The "Cable break" symbol is displayed in the "Signal and error display" area of the display.

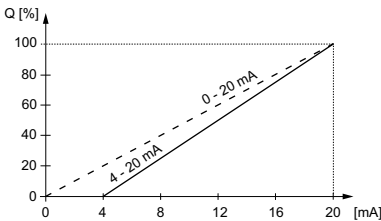

Fig. 17 Analog scaling

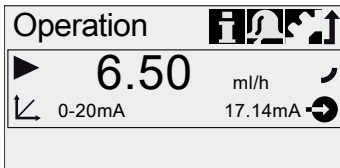

Fig. 18 Analog operation mode

Set analog scaling

Analog scaling refers to the assignment of the current input value to the dosing flow.

Changes of analog scaling affect also the analog output signal. See section 6.5 Analog output.

Analog scaling passes through the two reference points (I_1/Q_1) and (I_2/Q_2), which are set in the "Setup > Analog scaling" menu. The dosing flow is controlled according to this setting.

Example 1 (DDA 7.5-16)

Analog scaling with positive gradient:

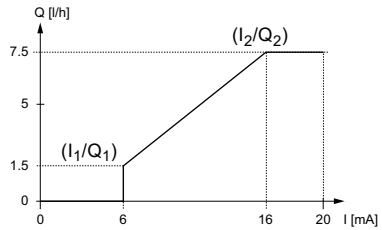

Fig. 19 Analog scaling with pos. gradient

In example 1, the reference points $I_1 = 6$ mA, $Q_1 = 1.5$ l/h and $I_2 = 16$ mA, $Q_2 = 7.5$ l/h have been set.

From 0 to 6 mA analog scaling is described by a line that passes through $Q = 0$ l/h, between 6 mA and 16 mA it rises proportionally from 1.5 l/h to 7.5 l/h and from 16 mA onwards it passes through $Q = 7.5$ l/h.

Example 2 (DDA 7.5-16)

Analog scaling with negative gradient (Operation mode 0-20 mA):

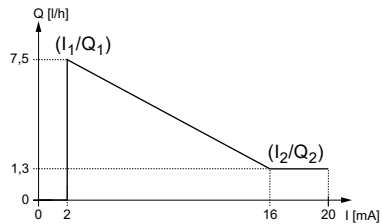

Fig. 20 Analog scaling with neg. gradient

In example 2, the reference points $I_1 = 2$ mA, $Q_1 = 7.5$ l/h and $I_2 = 16$ mA, $Q_2 = 1.3$ l/h have been set.

From 0 to 2 mA analog scaling is described by a line that passes through $Q = 0$ l/h, between 2 mA and 16 mA it drops proportionally from 7.5 l/h to 1.3 l/h and from 16 mA onwards it passes through $Q_2 = 1.3$ l/h.

TM04 1160 2010

TM04 1120 2010

TM04 1127 1110

TM04 1101 2010

Set analog scaling in the "Operation" menu

Analog scaling can also be modified after a security prompt directly in the "Operation" menu. This is how the dosing flow is directly modified for the current flow input value.

Caution Please observe that changes also have a direct effect on point I_2/Q_2 (see fig. 21)!

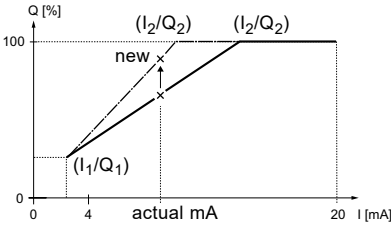

Fig. 21 Set analog scaling ("Operation" menu)

6.4.4 Batch (pulse-based)

In this operation mode, the pump doses the set batch volume in the set dosing time (t_1). A batch is dosed with each incoming pulse.

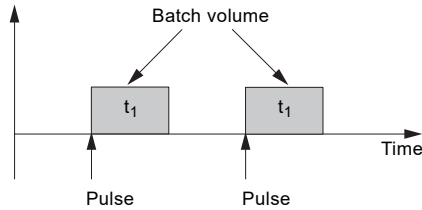

Fig. 22 Batch (pulse-based)

The setting range depends on the pump type:

Type	Setting range per batch		Resolution* [ml]
	from [ml]	to [l]	
DDA 7.5-16	0.74	999	0.0925
DDA 12-10	1.45	999	0.1813
DDA 17-7	1.55	999	0.1938
DDA 30-4	3.10	999	0.3875

* Thanks to the digital motor control, dosing quantities with a resolution of up to 1/8 of the dosing stroke volume can be dosed.

The batch volume (e.g. 75 ml) is set in the "Setup > Batch volume" menu. The minimum dosing time required for this (e.g. 36 seconds) is displayed and can be increased.

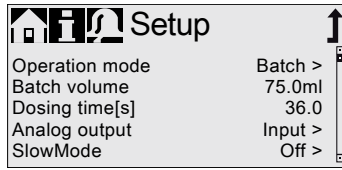

Fig. 23 Batch mode

Signals received during a batch process or an interruption (e.g. alarm, External stop) will be ignored. If the pump is restarted following an interruption, the next batch volume is dosed on the next incoming pulse.

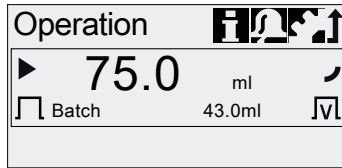

Fig. 24 Batch mode

In the "Operation" menu, the total batch volume (e.g. 75 ml) and the remaining batch volume still to be dosed (e.g. 43 ml) are shown in the display.

6.4.5 Dosing timer cycle

In this operation mode, the pump doses the set batch volume in regular cycles. Dosing starts when the pump is started after a singular start delay. The setting range for the batch volume corresponds to the values in section 6.4.4 *Batch (pulse-based)*.

Warning

When time or date is changed in "Time+date" menu, timer dosing and timer relay output functions (Relay 2) are stopped!



Timer dosing and timer relay output functions must be restarted manually!

Changing time or date can cause increase or decrease in concentration!

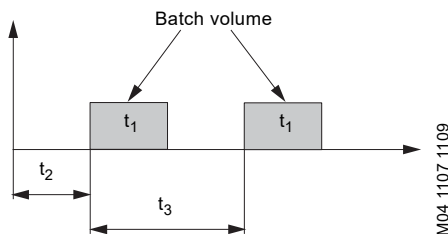

Fig. 25 Dosing timer cycle diagram

t_1	Dosing time
t_2	Start delay
t_3	Cycle time

In the event of an interruption (e.g. interruption of the mains voltage, External stop), the dosing will be stopped while the time continues running. After suspending the interruption, the pump will continue to dose according to the actual timeline position.

The following settings are required in the "Setup > Dosing timer cycle" menu:

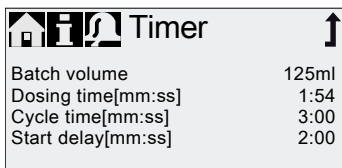

Fig. 26 Dosing timer cycle

The batch volume to be dosed (e.g. 125 ml) is set in the "Setup > Dosing timer cycle" menu. The dosing time required for this (e.g. 1:54) is displayed and can be changed.

The total batch volume (e.g. 125 ml) and the remaining batch volume still to be dosed are displayed in the "Operation" menu. During breaks in dosing, the time until the next dosing process (e.g. 1:21) is displayed.

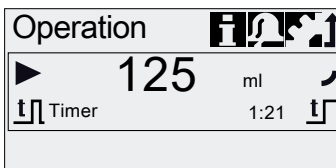

Fig. 27 Dosing timer cycle

6.4.6 Dosing timer week

In this operation mode, up to 16 dosing procedures are defined for a week. These dosing procedures may take place regularly on one or several week days. The setting range for the batch volume corresponds to the values in section 6.4.4 *Batch (pulse-based)*.

Warning

When time or date is changed in "Time+date" menu, timer dosing and timer relay output functions (Relay 2) are stopped!



Timer dosing and timer relay output functions must be restarted manually!

Changing time or date can cause increase or decrease in concentration!

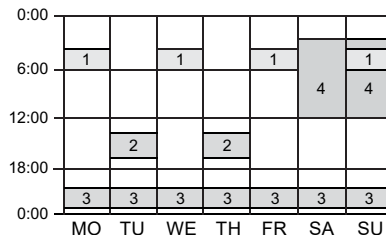

Fig. 28 Example for Dosing timer week function

Note If several procedures overlap, the process with the higher dosing flow has priority!

In the event of an interruption (e.g. disconnection of the mains voltage, External stop), the dosing is stopped while the time continues running. After suspending the interruption, the pump continues to dose according to the actual timeline position.

TM04 1136 2011

TM04 1107 1109

TM04 1108 1109

TM04 1137 1110

The following settings are required in the "Setup > Dosing timer week" menu for each dosing procedure:

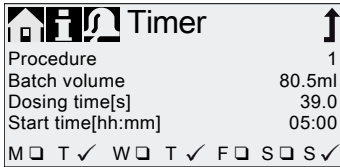

Fig. 29 Setting the timer

The batch volume (e.g. 80.5 ml) is set in the "Setup > Dosing timer week" menu. The dosing time required for this (e.g. 39.0) is displayed and can be changed.

In the "Operation" menu, the total batch volume (e.g. 80.5 ml) and the remaining batch volume to be dosed is displayed. During breaks in dosing, the time (e.g. 43:32) until the next dosing is displayed.

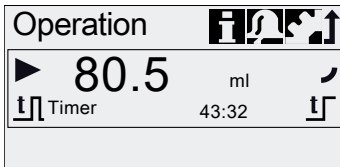

Fig. 30 Weekly timer dosing (break in dosing)

6.5 Analog output

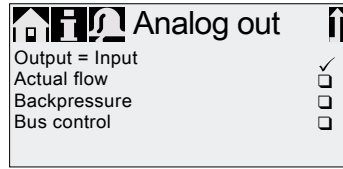

Fig. 31 Configure analog output

The analog output of the pump is parametrised in the "Setup > Analog output" menu. The following settings are possible:

Setting	Description of output signal	Variant		
		FCM	FC	AR
Output = Input	Analog feedback signal (not for master-slave application). The analog input signal is mapped 1:1 to the analog output.	X	X	X
Actual flow**	Current actual flow • 0/4 mA = 0 % • 20 mA = 100 % see section 6.9 Flow measurement	X	X*	X*
Backpressure	Backpressure, measured in the dosing head • 0/4 mA = 0 bar • 20 mA = Max. operating pressure see section 6.8 Pressure monitoring	X	X	
Bus control	Enabled by command in Bus control, see section 6.15 Bus communication	X	X	X

* Output signal is based on motor speed and pump status (target flow).

** Signal has same analog scaling as the current analog input signal. See [6.4.3 Analog 0/4-20 mA](#).

Wiring diagram see section [4.3 Electrical connection](#).

In all operation modes, the analog output has a range of 4-20 mA. Exception:

Note

Operation mode 0-20 mA. Here, the analog output range is 0-20 mA.

6.6 SlowMode



When the "SlowMode" function is enabled, the pump slows down the suction stroke. The function is enabled in the "Setup > SlowMode" menu and is used to prevent cavitation in the following cases:

- for dosing media with a high viscosity
- for degassing dosing media
- for long suction lines
- for large suction lift.

In the "Setup > SlowMode" menu, the speed of the suction stroke can be reduced to 50 % or 25 %.

Caution

Enabling the 'SlowMode' function reduces the maximum dosing flow of the pump to the set percentage value!

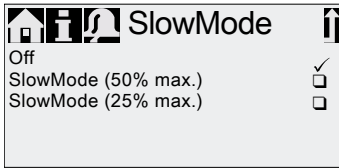

TM04 1153 1110

Fig. 32 SlowMode menu

6.7 FlowControl



Applies to DDA-FC/FCM control variant.

This function is used to monitor the dosing process. Although the pump is running, various influences e.g. air bubbles, can cause a reduced flow or even stop the dosing process. In order to guarantee optimum process safety, the enabled "FlowControl" function directly detects and indicates the following errors and deviations:

- Overpressure
- Damaged discharge line
- Air in the dosing chamber
- Cavitation
- Suction valve leakage > 70 %
- Discharge valve leakage > 70 %.

The occurrence of a fault is indicated by the "eye" symbol flashing. The faults are displayed in the "Alarm" menu (see section 8. [Faults](#)).

FlowControl works with a maintenance-free sensor in the dosing head. During the dosing process, the sensor measures the current pressure and continuously sends the measured value to the microprocessor in the pump. An internal indicator diagram is created from the current measured values and the current diaphragm position (stroke length). Causes for deviations can be identified immediately by aligning the current indicator diagram with a calculated optimum indicator diagram. Air bubbles in the dosing head reduce e.g. the discharge phase and consequently the stroke volume (see fig. 33).

Requirements for a correct indicator diagram are:

- FlowControl function is active
- pressure difference between suction and discharge side is > 2 bar
- No interruption/pause in discharge stroke
- Pressure sensor and cable are functioning properly
- No leakage > 50 % in suction or discharge valve

If one of these requirements is not met, the indicator diagram cannot be evaluated.

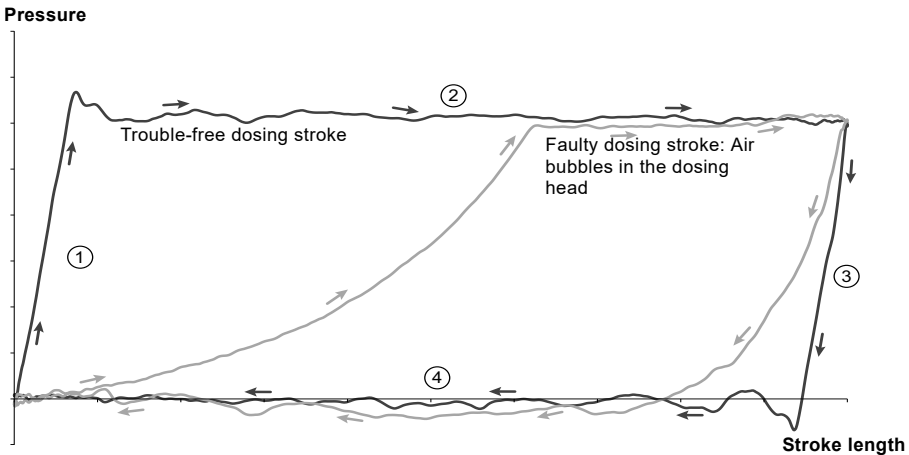

TM04 1610 1710

Fig. 33 Indicator diagram

1	Compression phase
2	Discharge phase
3	Expansion phase
4	Suction phase

Setting FlowControl

The "FlowControl" function is set using the two parameters "Sensitivity" and "Delay" in the "Setup > FlowControl" menu.

Sensitivity

In "Sensitivity" the deviation in stroke volume, which will result in an error message, is set in percent.

Sensitivity	Deviation
low	approx. 70 %
medium	approx. 50 %
high	approx. 30 %

Delay

The "Delay" parameter is used to define the time period until an error message is generated: "short", "medium" or "long". The delay depends on the set dosing flow and therefore cannot be measured in strokes or time.

Air bubbles

The "FlowControl" function identifies air bubbles > 60 % of the stroke volume. After switching to "Air bubble" warning status, the pump adapts the stroke frequency to approximately 30-40 % of max. stroke frequency, and starts a special motor drive strategy. The adaptation of the stroke frequency allows the air bubbles to rise from suction to discharge valve. Due to the special motor drive strategy the air bubbles are displaced from the dosing head into the discharge line.

If the air bubbles have not been eliminated after a maximum of 60 strokes, the pump returns to the normal motor drive strategy.

6.8 Pressure monitoring

Applies to DDA-FC/FCM control variant.

A pressure sensor monitors the pressure in the dosing head. If the pressure during the discharge phase falls below 2 bar, a warning is generated (pump continues running). If in the "Setup > Pressure monitoring" menu the function "Min. pressure alarm" is activated, an alarm is generated and the pump is stopped.

If the pressure exceeds the "Max. pressure" set in the "Setup > Pressure monitoring" menu, the pump is shut down, enters the standby state and indicates an alarm.

Caution The pump restarts automatically once the backpressure falls below the set "Max. pressure"!

6.8.1 Pressure setting ranges

Type	Fixed min. pressure [bar]	Adjustable max. pressure [bar]
DDA 7.5-16	< 2	3-17
DDA 12-10	< 2	3-11
DDA 17-7	< 2	3-8
DDA 30-4	< 2	3-5

Warning
Install a pressure-relief valve in the pressure line to provide protection against impermissibly high pressure!

The pressure measured in the dosing head is slightly higher than the actual system pressure.

Caution Therefore the "Max. pressure" should be set at least 0.5 bar higher than the system pressure.

6.8.2 Calibration of pressure sensor

The pressure sensor is calibrated in the factory. As a rule, it does not need to be re-calibrated. If specific circumstances (e.g. pressure sensor exchange, extreme air pressure values at the location of the pump) necessitate a calibration, the sensor can be calibrated as follows:

1. Set pump to "Stop" operating state.
2. Make system pressureless and flush.
3. Dismantle suction line and suction valve.



Warning

Calibrating when the suction valve is installed produces incorrect calibration and can cause personal injuries and damage to property!

Only carry out a calibration if this is technically required!

4. Proceed as described below to calibrate:

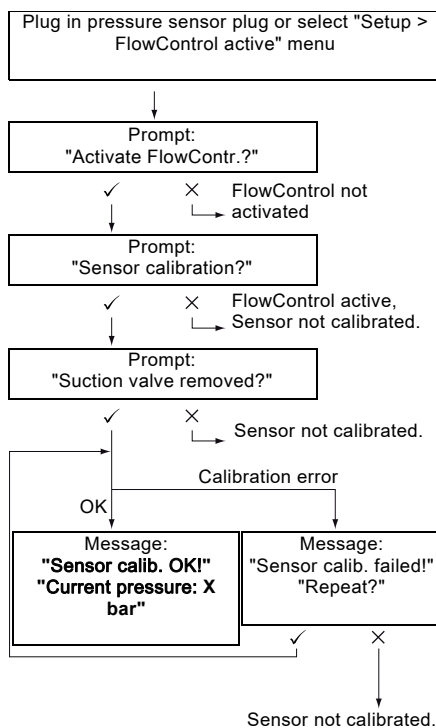

If a calibration is not successfully possible, check plug connections, cable and sensor and replace defective parts where necessary.

6.9 Flow measurement

Applies to DDA-FCM control variant.

The pump accurately measures the actual flow and displays it. Via the 0/4-20 mA analog output, the actual flow signal can easily be integrated into an external process control without additional measuring equipment (see section [6.5 Analog output](#)).

The flow measurement is based on the indicator diagram as described in section [6.7 FlowControl](#). The accumulated length of the discharge phase multiplied by the stroke frequency produces the displayed actual flow. Faults e.g. air bubbles or backpressure that is too low result in a smaller or larger actual flow. When the "AutoFlowAdapt" function is activated (see section [6.10 AutoFlowAdapt](#)), the pump compensates for these influences by correction of the stroke frequency.

Note Strokes which cannot be analysed (partial strokes, pressure differential which is too low) are provisionally calculated based on the setpoint value and displayed.

6.10 AutoFlowAdapt

Applies to DDA-FCM control variant.

The "AutoFlowAdapt" function is activated in the "Setup" menu. It detects changes in various parameters and responds accordingly in order to keep the set target flow constant.

Note Dosing accuracy is increased when "AutoFlowAdapt" is activated.

This function processes information from the pressure sensor in the dosing head. Errors detected by the sensor are processed by the software. The pump responds immediately regardless of the operation mode by adjusting the stroke frequency or where necessary compensating for the deviations with a corresponding indicator diagram.

If the target flow cannot be achieved by the adjustments, a warning is issued.

"AutoFlowAdapt" operates on the basis of the following functions:

- FlowControl: malfunctions are identified (see section [6.7 FlowControl](#)).
- Pressure monitoring: pressure fluctuations are identified (see section [6.8 Pressure monitoring](#)).
- Flow measurement: deviations from the target flow are identified (see section [6.9 Flow measurement](#)).

Example of "AutoFlowAdapt"

Pressure fluctuations

The dosing volume decreases as backpressure increases and conversely the dosing volume increases as the backpressure decreases.

The "AutoFlowAdapt" function identifies pressure fluctuations and responds by adjusting the stroke frequency. The actual flow is thus maintained at a constant level.

6.11 Auto deaeration

Dosing degassing media can result in air pockets in the dosing head during breaks in dosing. This can result in no medium being dosed when restarting the pump. The "Setup > Auto deaeration" function performs pump deaeration automatically at regular intervals. Software-controlled diaphragm movements encourage any bubbles to rise and gather at the discharge valve so that they can be removed on the next dosing stroke.

The function works:

- when the pump is not in the "Stop" operating state
- during breaks in dosing (e.g. External stop, no incoming pulses, etc.).

The diaphragm movements can displace small volumes into the discharge line.

Note When dosing strongly degassing media, this is however virtually impossible.

6.12 Key lock

The key lock is set in the "Setup > Key lock" menu by entering a four-digit code. It protects the pump by preventing changes to settings. Two levels of key lock can be selected:

Level	Description
Settings	All settings can only be changed by entering the lock code. The [Start/stop] key and the [100%] key are not locked.
Settings + keys	The [Start/stop] key and the [100%] key and all settings are locked.

It is still possible to navigate in the "Alarm" and "Info" main menu and reset alarms.

6.12.1 Temporary deactivation

If the "Key lock" function is activated but settings need to be modified, the keys can be unlocked temporarily by entering the deactivation code. If the code is not entered within 10 seconds, the display automatically switches to the "Operation" main menu. The key lock remains active.

6.12.2 Deactivation

The key lock can be deactivated in the "Setup > Key lock" menu via the "Off" menu point. The key lock is deactivated after the general code "2583" or a pre-defined custom code has been entered.

6.13 Display Setup

Use the following settings in the "Setup > Display" menu to adjust the display properties:

- Units (metric/US)
- Display contrast
- Additional display.

6.13.1 Units

Metric units (litres/millilitres/bar) or US units (US gallons/PSI) can be selected. According to the operation mode and menu, the following units of measurement are displayed:

Operation mode / function	Metric units	US units
Manual control	ml/h or l/h	gph
Pulse control	ml/□	ml/□
0/4-20 mA Analog control	ml/h or l/h	gph
Batch (pulse- or timer-controlled)	ml or l	gal
Calibration	ml	ml
Volume counter	l	gal
Pressure monitoring	bar	psi

6.13.2 Additional display

The additional display provides additional information about the current pump status. The value is shown in the display with the corresponding symbol.

In "Manual" mode the "Actual flow" information can be displayed with Q = 1.28 l/h (see fig. 34).

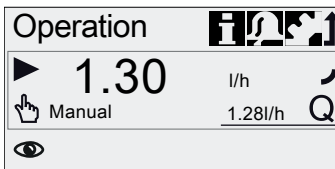

Additional display ←

Fig. 34 Display with additional display

The additional display can be set as follows:

Setting	Description
	Depending on the operation mode:
	Q Actual flow (Manual/Pulse) ^{1), 2)}
	Q Target flow (Pulse)
Default display	↻ Input current (analog)
	√l Remaining batch volume (Batch, Timer)
	t□ Period until next dosing (Timer)
Dosed volume	V Dosed vol. since last reset (see Counters on page 21)
Actual flow	Q Current actual flow ¹⁾
Backpressure	P Current backpressure in the dosing head ³⁾

1) only DDA-FCM control variant

2) only if indicator diagram can be evaluated (see [6.7 FlowControl](#))

3) only DDA-FCM/FC control variant

6.14 Time+date

The time and date can be set in the "Setup > Time+date" menu.

Warning

When time or date is changed in "Time+date" menu, timer dosing and timer relay output functions (Relay 2) are stopped!



Timer dosing and timer relay output functions must be restarted manually!

Changing time or date can cause increase or decrease in concentration!

Caution

The conversion between summer and winter time does not take place automatically!

TM04 1151 2011

6.15 Bus communication

BUS

The bus communication enables remote monitoring and setting of the pump via a fieldbus system.

Further manuals, functional profiles and support files (e.g. GSD-files) are available on the CD delivered with the interface hardware and on www.grundfos.com.

6.15.1 GENIbus communication

The pump is supplied with an integrated module for GENIbus communication. The pump identifies the bus control after connecting to the corresponding signal input. The "Activate communication?" prompt is displayed. After confirmation, the corresponding symbol appears in the "Activated functions" area in the "Operation" menu.

In the "Setup > Bus" menu the GENIbus address can be set from 32 to 231 and bus control can be deactivated.



Fig. 35 Bus menu

TM04 1139 2410

Caution

The maximum cable length for GENIbus connection is 3 m and must not be exceeded!

6.15.2 Possible industrial bus types

The pump can be integrated into several networks using the additional E-box (Extension-Box).

Bus type	Interface hardware	Retrofitting possible for pump software
Profibus® DP	E-Box 150	V2.5 and higher
Modbus RTU	E-Box 200	V2.5 and higher
Ethernet	E-Box 500	V2.5 and higher

The pump can also be connected to a Grundfos CIU unit (CIU = Communication Interface Unit) equipped with one of the following CIM modules (CIM = Communication Interface Module):

- CIM150 Profibus
- CIM200 Modbus
- CIM270 GRM
- CIM500 Ethernet

For internal communication between the E-Box/CIU and the dosing pump, GENIbus is used.

Caution

The maximum cable length for GENIbus connection is 3 m and must not be exceeded!

Caution

Prior to installation and start-up, read the documentation delivered with the E-Box or CIU unit!

6.15.3 Activate communication

1. Set the pump to operating state "Stop" with the [Start/stop] key.
2. Switch off the power supply of the pump.
3. Install and connect the E-Box/CIU as described in the respective separate installation and operating instructions.
4. Switch on the power supply of the pump.

The "Activate communication?" prompt is displayed.

After confirmation, the "Bus" symbol appears in the "Activated functions" area of the "Operation" menu, no matter if the prompt was accepted or refused.

If the prompt has been accepted, the bus control function is activated. If the prompt has been refused, bus control function can be activated in "Setup > Bus" menu.



Fig. 36 Example of submenu for Profibus®

TM04 1139 2410

6.15.4 Setting the bus address

1. Enter "Setup > Bus" menu and set desired bus address:

Bus type	Address range
Profibus® DP	0-126
Modbus RTU	1-247

2. The pump needs to be restarted to initialise the new bus address. Switch off the power supply of the pump and wait for approximately 20 seconds.
 3. Switch on the power supply of the pump.
- The pump is initialised with the new bus address.

6.15.5 Characteristics of bus communication

To start and stop the pump via bus, it needs to be in operating state "Running". When the pump is remotely stopped from bus, the "External stop" symbol is displayed and the pump switches to operating state "Standby".

While bus control function is activated, the "Setup" menu only shows the "Bus" and "Key lock" submenus. The other main menus, the "External stop" function and the keys are still available.

All operation modes (see section [6.4 Operation modes](#)) can still be used when bus control is activated. This allows to use the bus control only for monitoring and setting the pump. In this case the respective "BusWatchDog" (see functional profile on E-Box/CIU product CD) should be deactivated in bus control, because otherwise faults in communication can stop the pump.

Note

To change any settings manually, the bus control function must be deactivated temporarily.

The analog output can not be used while the pump is bus-controlled as both functions use the same electrical connection. See section [4.3 Electrical connection](#).

6.15.6 Deactivate communication

Warning



After deactivating the bus control function, the pump can start automatically!

Before deactivating the bus control function, set the pump to operating state "Stop"!

Bus control function can be deactivated in the "Setup > Bus" menu. After deactivation all submenus in "Setup" menu are available.

The "Bus" symbol in the display disappears at next restart of the pump, after the E-Box/CIU plug was disconnected.

Caution

After disconnecting any plug, always refit protective cap!

6.15.7 Communication faults

Faults are only detected, if the respective "BusWatchDog" (see functional profile on E-Box/CIU product CD) is activated.

Warning



After a communication fault is repaired, the pump can start automatically, depending on current bus control and pump settings!

Before repairing any fault, set the pump to operating state "Stop"!

In case of bus communication faults (e.g. communication cable break), the pump stops dosing and switches to operating state "Standby" approximately 10 seconds after the fault was detected. An alarm is triggered, detailing the cause of the fault. See section [8. Faults](#).

6.16 Inputs/Outputs

In the "Setup > Inputs/Outputs" menu, you can configure the two outputs "Relay 1+Relay 2" and the signal inputs "External stop", "Empty signal" and "Low-level signal".

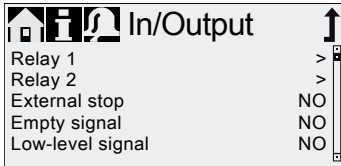

Fig. 37 Inputs/Outputs menu

Warning

When time or date is changed in "Time+date" menu, timer dosing and timer relay output functions (Relay 2) are stopped!



Timer dosing and timer relay output functions must be restarted manually!

Changing time or date can cause increase or decrease in concentration!

TM04 1152 1110

6.16.1 Relay outputs

The pump can switch two external signals using installed relays. The relays are switched by potential-free pulses. The connection diagram of the relays is shown in section 4.3 *Electrical connection*. Both relays can be allocated with the following signals:

Relay 1 signal	Relay 2 signal	Description
Alarm*	Alarm	Display red, pump stopped (e.g. empty signal, etc.)
Warning*	Warning	Display yellow, pump is running (e.g. low-level signal, etc.)
Stroke signal	Stroke signal	Each full stroke
Pump dosing	Pump dosing*	Pump running and dosing
Pulse input**	Pulse input**	Each incoming pulse from pulse input
Bus control	Bus control	Activated by a command in the bus communication
	Timer Cycle	See following sections
	Timer Week	See following sections
Contact type		
NO*	NO*	Normally open contact
NC	NC	Normally closed contact

* Factory setting

** The correct transmission of incoming pulses can only be guaranteed up to a pulse frequency of 5 Hz.

Timer Cycle (Relay 2)

For the "Relay 2 > Timer Cycle" function, set the following parameters:

- On (t_1)
- Start delay (t_2)
- Cycle time (t_3)

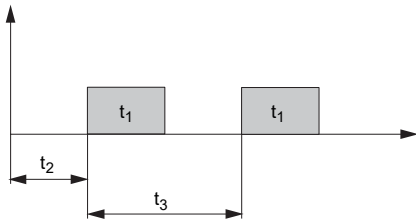

Fig. 38 Diagram

TM04 1124 2110

Timer Week (Relay 2)

This function saves up to 16 relay on-times for a week. The following settings can be made for each relay switching operation in the "Relay 2 > Timer Week" menu:

- Procedure (No.)
- On time (duration)
- Start time
- Weekdays.

6.16.2 External stop

The pump can be stopped via an external contact, e.g. from a control room. When activating the external stop signal, the pump switches from the operating state "Running" into the operating state "Standby". The corresponding symbol appears in the "Signal/error display" area of the display.

Frequent disengagement from the mains voltage, e.g. via a relay, can result in damage to the pump electronics and in the breakdown of the pump. The dosing accuracy is also reduced as a result of internal start procedures.

Caution

Do not control the pump via the mains voltage for dosing purposes!

Only use the "External stop" function to start and stop the pump!

The contact type is factory-set to normally open contact (NO). In the "Setup > Inputs/Outputs > External stop" menu, the setting can be changed to normally closed contact (NC).

6.16.3 Empty and Low level signals

In order to monitor the filling level in the tank, a dual-level sensor can be connected to the pump. The pump responds to the signals as follows:

Sensor signal	Pump status
Low level	<ul style="list-style-type: none"> • Display is yellow • ▼ Flashes • Pump continues running
Empty	<ul style="list-style-type: none"> • Display is red • ▼ Flashes • Pump stops

Caution

When the tank is filled up again, the pump restarts automatically!

Both signal inputs are allocated to the normally open contact (NO) in the factory. They can be re-allocated in the "Setup > Inputs/Outputs" menu to normally closed contact (NC).

6.17 Basic settings

All settings can be reset to the settings default upon delivery in the "Setup > Basic settings" menu.

Selecting "Save customer settings" saves the current configuration to the memory. This can then be activated using "Load customer settings".

The memory always contains the previously saved configuration. Older memory data is overwritten.

7. Service



In order to ensure a long service life and dosing accuracy, wearing parts such as diaphragms and valves must be regularly checked for signs of wear. Where necessary, replace worn parts with original spare parts made from suitable materials.

Should you have any questions, please contact your service partner.



Warning

Maintenance work must only be carried out by qualified staff.

7.1 Regular maintenance

Interval	Task
Daily	<p>Check, if liquid leaks from the drain opening (fig. 41, pos. 11) and if the drain opening is blocked or soiled. If so, follow the instructions given in section 7.6 <i>Diaphragm breakage</i>.</p> <p>Check, if liquid leaks from the dosing head or valves. If necessary, tighten dosing head screws with a torque wrench at 4 Nm. If necessary, tighten valves and cap nuts, or perform service (see 7.4 <i>Perform service</i>).</p> <p>Check, if a service requirement is present at the pump display. If so, follow the instructions given in section 7.3 <i>Service system</i>.</p>
Weekly	Clean all pump surfaces with a dry and clean cloth.
Every 3 months	<p>Check dosing head screws. If necessary, tighten dosing head screws with a torque wrench at 4 Nm. Replace damaged screws immediately.</p>

7.2 Cleaning

If necessary, clean all pump surfaces with a dry and clean cloth.

7.3 Service system

According to the motor runtime or after a defined period of operation, service requirements will appear. Service requirements appear regardless of the current operating state of the pump and do not affect the dosing process.

Service requirement	Motor runtime [h]*	Time interval [months]*
Service soon!	7500	23
Service now!	8000	24

* Since the last service system reset

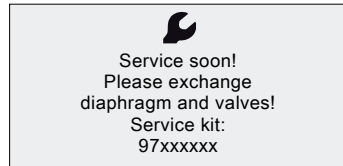

Fig. 39 Service soon!

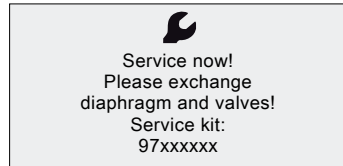

Fig. 40 Service now!

Caution For media which result in increased wear, the service interval must be shortened.

The service requirement signals when the replacement of wearing parts is due and displays the number of the service kit. Press the click wheel to temporarily hide the service prompt.

When the "Service now!" message appears (displayed daily), the pump must be serviced immediately. The symbol appears in the "Operation" menu.

The number of the service kit required is also displayed in the "Info" menu.

TM04 1131 1110

TM04 1131 1110

7.4 Perform service

Only spare parts and accessories from Grundfos should be used for maintenance. The usage of non-original spare parts and accessories renders any liability for resulting damages null and void.

Further information about carrying out maintenance can be found in the service kit catalogue on our homepage. See www.grundfos.com.

Warning

Risk of chemical burns!

When dosing dangerous media, observe the corresponding precautions in the safety data sheets!



Wear protective clothing (gloves and goggles) when working on the dosing head, connections or lines!

Do not allow any chemicals to leak from the pump. Collect and dispose of all chemicals correctly!

Before any work to the pump, the pump must be in the "Stop" operating state or be disconnected from the power supply. The system must be pressureless!

Caution

7.4.1 Dosing head overview

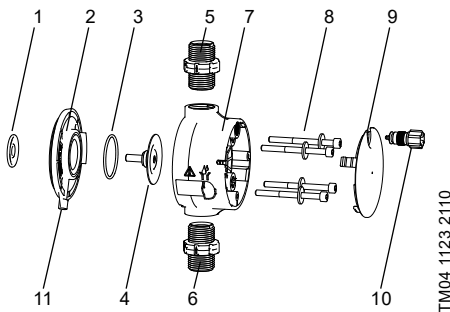

TM04 1123 2110

Fig. 41 Changing the diaphragm and valves

1	Safety diaphragm
2	Flange
3	O-ring
4	Diaphragm
5	Valve on discharge side
6	Valve on suction side
7	Dosing head
8	Screws with discs
9	Cover
10	Deaeration valve
11	Drain opening

7.4.2 Dismantling the diaphragm and valves

Warning

Danger of explosion, if dosing liquid has entered the pump housing!



If the diaphragm is possibly damaged, don't connect the pump to the power supply! Proceed as described in section [7.6 Diaphragm breakage!](#)

This section refers to [fig. 41](#).

1. Make system pressureless.
2. Empty dosing head before maintenance and flush it if necessary.
3. Set pump to "Stop" ■ operating state using the [Start/stop] key.
4. Press the [Start/stop] and [100%] keys at the same time to put the diaphragm into "out" position.
 - Symbol (–) must be displayed (see [fig. 14](#)).
5. Take suitable steps to ensure that the returning liquid is safely collected.
6. Dismantle suction, pressure and deaeration hose.
7. Dismantle valves on suction and discharge side (5, 6).
8. Remove the cover (9).
9. Loosen screws (8) on the dosing head (7) and remove with discs.
10. Remove the dosing head (7).
11. Unscrew diaphragm (4) counter-clockwise and remove with flange (2).
12. Make sure the drain opening (11) is not blocked or soiled. Clean if necessary.
13. Check the safety diaphragm (1) for wear and damage. Replace if necessary.

If nothing indicates that dosing liquid has entered the pump housing, go on as described in section [7.4.3 Reassembling the diaphragm and valves](#). Otherwise proceed as described in section [7.6.2 Dosing liquid in the pump housing](#).

7.4.3 Reassembling the diaphragm and valves

The pump must only be reassembled, if nothing indicates that dosing liquid has entered the pump housing. Otherwise proceed as described in section [7.6.2 Dosing liquid in the pump housing](#).

This section refers to fig. 41.

1. Attach flange (2) correctly and screw on new diaphragm (4) clockwise.
 - Make sure that the O-ring (3) is seated correctly!
2. Press the [Start/stop] and [100%] keys at the same time to put the diaphragm into "in" position.
 - Symbol – must be displayed (see fig. 14).
3. Attach the dosing head (7).
4. Install screws with discs (8) and cross-tighten with a torque wrench.
 - Torque: 4 Nm.
5. Attach the cover (9).
6. Install new valves (5, 6).
 - Do not interchange valves and pay attention to direction of arrow.
7. Connect suction, pressure and deaeration hose (see section [4.2 Hydraulic connection](#))
8. Press the [Start/stop] key to leave the service mode.

Caution

Tighten the dosing head screws with a torque wrench once before commissioning and again after 2-5 operating hours at 4 Nm.

9. Deaerate dosing pump (see section [5.2 Deaerating the pump](#)).
10. Please observe the notes on commissioning in section [5. Startup!](#)

7.5 Resetting the service system

After performing the service, the service system must be reset using the "Info > Reset service system" function.

7.6 Diaphragm breakage

If the diaphragm leaks or is broken, dosing liquid escapes from the drain opening (fig. 41, pos. 11) on the dosing head.

In case of diaphragm breakage, the safety diaphragm (fig. 41, pos. 1) protects the pump housing against ingress of dosing liquid.

When dosing crystallising liquids the drain opening can be blocked by crystallisation. If the pump is not taken out of operation immediately, a pressure can build up between the diaphragm (fig. 41, pos. 4) and the safety diaphragm in the flange (fig. 41, pos. 2). The pressure can press dosing liquid through the safety diaphragm into the pump housing.

Most dosing liquids don't cause any danger when entering the pump housing. However a view liquids can cause a chemical reaction with inner parts of the pump. In the worst case, this reaction can produce explosive gases in the pump housing.

Warning

Danger of explosion, if dosing liquid has entered the pump housing!

Operation with damaged diaphragm can lead to dosing liquid entering the pump housing.

In case of diaphragm breakage, immediately separate the pump from the power supply!

Make sure the pump cannot be put back into operation by accident!

Dismantle the dosing head without connecting the pump to the power supply and make sure no dosing liquid has entered the pump housing. Proceed as described in section [7.6.1 Dismantling in case of diaphragm breakage](#).



To avoid any danger resulting from diaphragm breakage, observe the following:

- Perform regular maintenance. See section [7.1 Regular maintenance](#).
- Never operate the pump with blocked or soiled drain opening.
 - If the drain opening is blocked or soiled, proceed as described in section [7.6.1 Dismantling in case of diaphragm breakage](#).
- Never attach a hose to the drain opening. If a hose is attached to the drain opening, it is impossible to recognise escaping dosing liquid.
- Take suitable precautions to prevent harm to health and damage to property from escaping dosing liquid.
- Never operate the pump with damaged or loose dosing head screws.

7.6.1 Dismantling in case of diaphragm breakage



Warning

Danger of explosion, if dosing liquid has entered the pump housing!

Do not connect the pump to the power supply!

This section refers to fig. 41.

1. Make system pressureless.
2. Empty dosing head before maintenance and flush it if necessary.
3. Take suitable steps to ensure that the returning liquid is safely collected.
4. Dismantle suction, pressure and deaeration hose.
5. Remove the cover (9).
6. Loosen screws (8) on the dosing head (7) and remove with discs.
7. Remove the dosing head (7).
8. Unscrew diaphragm (4) counter-clockwise and remove with flange (2).
9. Make sure the drain opening (11) is not blocked or soiled. Clean if necessary.
10. Check the safety diaphragm (1) for wear and damage. Replace if necessary.

If nothing indicates that dosing liquid has entered the pump housing, go on as described in section

[7.4.3 Reassembling the diaphragm and valves.](#)

Otherwise proceed as described in section

[7.6.2 Dosing liquid in the pump housing.](#)

7.6.2 Dosing liquid in the pump housing



Warning

Danger of explosion!

Immediately separate the pump from the power supply!

Make sure the pump cannot be put back into operation by accident!

If dosing liquid has entered the pump housing:

- Send the pump to Grundfos for repair, following the instructions given in section [7.7 Repairs](#).
- If a repair isn't economically reasonable, dispose of the pump observing the information in section [9. Disposal](#).

7.7 Repairs



Warning

The pump housing must only be opened by personnel authorised by Grundfos!

Repairs must only be carried out by authorised and qualified personnel!

Switch off the pump and disconnect it from the voltage supply before carrying out maintenance work and repairs!

After consulting Grundfos, please send the pump, together with the safety declaration completed by a specialist, to Grundfos. The safety declaration can be found at the end of these instructions. It must be copied, completed and attached to the pump.

The pump must be cleaned prior to dispatch!

Caution

If dosing liquid has possibly entered the pump housing, state that explicitly in the safety declaration! Observe section [7.6 Diaphragm breakage](#).

If the above requirements are not met, Grundfos may refuse to accept delivery of the pump. The shipping costs will be charged to the sender.

8. Faults



In the event of faults in the dosing pump, a warning or an alarm is triggered.

The corresponding fault symbol flashes in the "Operation" menu, see section [8.1 List of faults](#). The cursor jumps to the "Alarm" main menu symbol. Press the click wheel to open the "Alarm" menu and, where necessary, faults to be acknowledged will be acknowledged.

A yellow display indicates a warning and the pump continues running.

A red display indicates an alarm and the pump is stopped.

The last 10 faults are stored in the "Alarm" main menu. When a new fault occurs, the oldest fault is deleted.

The two most recent faults are shown in the display, you can scroll through all the other faults. The time and cause of the fault are displayed.

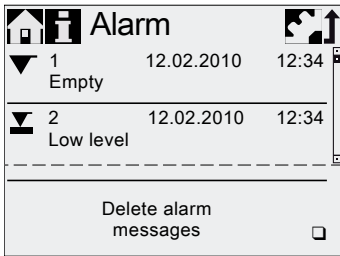

TM04 1109 10 10





The list of faults can be deleted at the end of the list.

If there is a service requirement, this appears when the "Alarm" menu is opened. Press the click wheel to temporarily close the service prompt (see section [7.3 Service system](#)).

8.1 List of faults

8.1.1 Faults with error message

Display in the "Alarm" menu	Possible cause	Possible remedy
▼ Empty (Alarm)	<ul style="list-style-type: none"> Dosing medium tank empty 	<ul style="list-style-type: none"> Fill tank. Check contact setting (NO/NC).
▼ Low level (Warning)	<ul style="list-style-type: none"> Dosing medium tank almost empty 	
Overpressure (Alarm)	<ul style="list-style-type: none"> Discharge valve blocked Isolating valve in discharge line closed Pressure peaks due to high viscosity Max. pressure set too low (see section 6.8 Pressure monitoring) 	<ul style="list-style-type: none"> Replace valve if necessary (see section 7.4 Perform service). Check flow direction of valves (arrow) and correct if necessary. Open the isolating valve (on the discharge side). Enlarge diameter of discharge line. Change pressure setting (see section 6.8 Pressure monitoring).
Low backpressure (Warning/alarm*)	<ul style="list-style-type: none"> Faulty diaphragm Broken discharge line Pressure differential between suction and discharge side too low Leakage in the pressure loading valve at Q < 1 l/h Deaeration valve open 	<ul style="list-style-type: none"> Change the diaphragm (see section 7.4 Perform service). Check discharge line and repair if necessary. Install additional spring-loaded valve (approx. 3 bar) on the discharge side. Close the deaeration valve.
Air bubble (Warning)	<ul style="list-style-type: none"> Broken/leaky suction line Strongly degassing medium Tank dosing medium empty 	<ul style="list-style-type: none"> Check suction line and repair if necessary. Provide positive inlet pressure (place dosing medium tank above the pump). Enable "SlowMode" (see section 6.6 SlowMode). Fill tank.
👁 Cavitation (Warning)	<ul style="list-style-type: none"> Blocked/constricted/squeezed suction line Blocked/constricted suction valve Suction lift too high Viscosity too high 	<ul style="list-style-type: none"> Enable "SlowMode" (see section 6.6 SlowMode). Reduce suction lift. Increase suction hose diameter. Check suction line and open isolating valve if necessary.
Suct. valve leak (Warning)	<ul style="list-style-type: none"> Leaky/dirty suction valve Deaeration valve open 	<ul style="list-style-type: none"> Check valve and tighten it up. Flush system. Replace valve if necessary (see section 7.4 Perform service). Check O-ring position. Install filter in suction line. Close the deaeration valve.
Disch. valve leak (Warning)	<ul style="list-style-type: none"> Leaky/dirty discharge valve Leakage in the pressure loading valve Deaeration valve open 	<ul style="list-style-type: none"> Check valve and tighten it up. Flush system. Replace valve if necessary (see section 7.4 Perform service). Check O-ring position. Install screen in suction line. Close the deaeration valve. Install spring-loaded valve on the discharge side.
Flow deviation (Warning)	<ul style="list-style-type: none"> Considerable deviation between target and actual flow Pump not or incorrectly calibrated 	<ul style="list-style-type: none"> Check installation. Calibrate the pump (see section 5.3 Calibrating the pump).

Display in the "Alarm" menu	Possible cause	Possible remedy
 Pressure sensor (Warning)	<ul style="list-style-type: none"> Broken "FlowControl" cable (see fig. 11) Sensor defect Pressure sensor not correctly calibrated. 	<ul style="list-style-type: none"> Check plug connection. Change sensor if necessary. Calibrate pressure sensor correctly (see section 6.8.2 Calibration of pressure sensor).
 Motor blocked (Alarm)	<ul style="list-style-type: none"> Backpressure greater than nominal pressure Damage to gears 	<ul style="list-style-type: none"> Reduce backpressure. Arrange for repair of gears, if necessary.
BUS Bus error (Alarm)	<ul style="list-style-type: none"> Fieldbus communication error 	<ul style="list-style-type: none"> Check cables for correct specification and damage; replace if necessary. Check cable routing and shielding; correct if necessary.
 E-Box (Alarm)	<ul style="list-style-type: none"> E-Box connection error Faulty E-Box 	<ul style="list-style-type: none"> Check plug connection. Replace E-Box if necessary.
 Cable break (Alarm)	<ul style="list-style-type: none"> Defect in analog cable 4-20 mA (input current < 2 mA) 	<ul style="list-style-type: none"> Check cable/plug connections and replace, if necessary. Check signal transmitter.
 Service now (Warning)	<ul style="list-style-type: none"> Time interval for service expired 	<ul style="list-style-type: none"> Perform service (see section 7.4 Perform service).

* Depending on setting

8.1.2 General faults

Fault	Possible cause	Possible remedy	
Dosing flow too high	Inlet pressure greater than backpressure	Install additional spring-loaded valve (approx. 3 bar) on the discharge side. Increase pressure differential.	
	Incorrect calibration	Calibrate the pump (see section 5.3 Calibrating the pump).	
	Air in dosing head	Deaerate the pump.	
	Faulty diaphragm	Change the diaphragm (see section 7.4 Perform service).	
	Leakage/fracture in lines	Check and repair lines.	
	Valves leaking or blocked	Check and clean valves.	
No dosing flow or dosing flow too low	Valves installed incorrectly	Check that the arrow on the valve housing is pointing in the direction of flow. Check whether all O-rings are installed correctly.	
	Blocked suction line	Clean suction line/install filter.	
	Suction lift too high	Reduce suction lift. Install priming aid. Enable "SlowMode" (see section 6.6 SlowMode).	
	Viscosity too high		Enable "SlowMode" (see section 6.6 SlowMode).
			Use hose with larger diameter.
			Install spring-loaded valve on the discharge side.
	Faulty calibration	Calibrate the pump (see section 5.3 Calibrating the pump).	
	Deaeration valve open	Close the deaeration valve.	
	Irregular dosing	Valves leaking or blocked	Tighten up valves, replace valves if necessary (see section 7.4 Perform service).
		Backpressure fluctuations	Keep backpressure constant. Activate "AutoFlowAdapt" (only DDA-FCM).
Liquid escaping from the drain opening on the flange	Faulty diaphragm	Immediately separate the pump from the power supply! Observe section 7. Service and especially section 7.6 Diaphragm leakage .	
Liquid escaping	Dosing head screws not tightened	Tighten up screws (see section 4.2 Hydraulic connection).	
	Valves not tightened	Tighten up valves/union nuts (see section 4.2 Hydraulic connection).	
Pump not sucking in	Suction lift too high	Reduce suction lift; if necessary, provide positive inlet pressure.	
	Backpressure too high	Open the deaeration valve.	
	Soiled valves	Flush system, replace valves if necessary (see section 7.4 Perform service).	

9. Disposal

This product or parts of it must be disposed of in an environmentally sound way. Use appropriate waste collection services. If this is not possible, contact the nearest Grundfos company or service workshop.



collection point designated by the local waste disposal authorities. The separate collection and recycling of such products will help protect the environment and human health.

See also end-of-life information at www.grundfos.com/product-recycling.



The crossed-out wheeled bin symbol on a product means that it must be disposed of separately from household waste. When a product marked with this symbol reaches its end of life, take it to a

中国 RoHS

产品中有害物质的名称及含量

部件名称	有害物质					
	铅 (Pb)	汞 (Hg)	镉 (Cd)	六价铬 (Cr6+)	多溴联苯 (PBB)	多溴联苯醚 (PBDE)
泵壳	X	O	O	O	O	O
印刷电路板	X	O	O	O	O	O
紧固件	X	O	O	O	O	O
管件	X	O	O	O	O	O
定子	X	O	O	O	O	O
转子	X	O	O	O	O	O

本表格依据 SJ/T 11364 的规定编制

O: 表示该有害物质在该部件所有均质材料中的含量均在 GB/T 26572 规定的限量要求以下。
X: 表示该有害物质至少在该部件的某一均质材料中的含量超出 GB/T 26572 该规定的限量要求。

 该产品环保使用期限为 10 年，标识如左图所示。
此环保期限只适用于产品在安装与使用说明书中所规定的条件下工作

Argentina

Bombas GRUNDFOS de Argentina S.A.
Ruta Panamericana km. 37.500 Centro
Industrial Garin
1619 - Garin Pcia. de B.A.
Phone: +54-3327 414 444
Telefax: +54-3327 45 3190

Australia

GRUNDFOS Pumps Pty. Ltd.
P.O. Box 2040
Regency Park
South Australia 5942
Phone: +61-8-8461-4611
Telefax: +61-8-8340 0155

Austria

GRUNDFOS Pumpen Vertrieb
Ges.m.b.H.
Grundfosstraße 2
A-5082 Grödig/Salzburg
Tel.: +43-6246-883-0
Telefax: +43-6246-883-30

Belgium

N.V. GRUNDFOS Bellux S.A.
Boomsesteenweg 81-83
B-2630 Aartselaar
Tél.: +32-3-870 7300
Télécopie: +32-3-870 7301

Belarus

Представительство ГРУНДФОС в
Минске 220125, Минск ул.
Шафарнянская, 11, оф. 56, БЦ «Порт»
Тел.: +375 17 397 397 3
+375 17 397 397 4
Факс: +375 17 397 397 1
E-mail: minsk@grundfos.com

Bosnia and Herzegovina

GRUNDFOS Sarajevo
Zmaja od Bosne 7-7A,
BH-71000 Sarajevo
Phone: +387 33 592 480
Telefax: +387 33 590 465
www.ba.grundfos.com
e-mail: grundfos@bih.net.ba

Brazil

BOMBAS GRUNDFOS DO BRASIL
Av. Humberto de Alencar Castelo
Branco, 630
CEP 09850 - 300
São Bernardo do Campo - SP
Phone: +55-11 4393 5533
Telefax: +55-11 4343 5015

Bulgaria

Grundfos Bulgaria EOOD
Slatina District
Iztochna Tangenta street no. 100
BG - 1592 Sofia
Tel. +359 2 49 22 200
Fax. +359 2 49 22 201
email: bulgaria@grundfos.bg

Canada

GRUNDFOS Canada Inc.
2941 Brighton Road
Oakville, Ontario
L6H 6C9
Phone: +1-905 829 9533
Telefax: +1-905 829 9512

China

Grundfos Alldos
Dosing & Disinfection
ALLDOS (Shanghai) Water Technology
Co. Ltd.
West Unit, 1 Floor, No. 2 Building (T 4-2)
278 Jinhui Road, Jin Qiao Export
Processing Zone
Pudong New Area
Shanghai, 201206
Phone: +86 21 5055 1012
Telefax: +86 21 5032 0596
E-mail:
grundfosalldos-CN@grundfos.com

China

GRUNDFOS Pumps (Shanghai) Co. Ltd.
10F The Hub, No. 33 Suhong Road
Minhang District
Shanghai 201106
PRC
Phone: +86-21 6122 5222
Telefax: +86-21 6122 5333

COLOMBIA

GRUNDFOS Colombia S.A.S.
Km 1.5 via Siberia-Cota Conj. Potrero
Chico,
Parque Empresarial Arcos de Cota Bod.
1A,
Cota, Cundinamarca
Phone: +57(1)-2913444
Telefax: +57(1)-8764586

Croatia

GRUNDFOS CROATIA d.o.o.
Buzinski prilaz 38, Buzin
HR-10010 Zagreb
Phone: +385 1 6595 400
Telefax: +385 1 6595 499
www.hr.grundfos.com

GRUNDFOS Sales Czechia and**Slovakia s.r.o.**

Čapkovského 21
779 00 Olomouc
Phone: +420-585-716 111

Denmark

GRUNDFOS DK A/S
Martin Bachs Vej 3
DK-8850 Bjerringbro
Tlf.: +45-87 50 50 50
Telefax: +45-87 50 51 51
E-mail: info_GDK@grundfos.com
www.grundfos.com/DK

Estonia

GRUNDFOS Pumps Eesti OÜ
Peterburi tee 92G
11415 Tallinn
Tel: + 372 606 1690
Fax: + 372 606 1691

Finland

OY GRUNDFOS Pumput AB
Trukkikujua 1
FI-01360 Vantaa
Phone: +358-(0)207 889 500

France

Pompes GRUNDFOS Distribution S.A.
Parc d'Activités de Chesnes
57, rue de Malacombe
F-38290 St. Quentin Fallavier (Lyon)
Tél.: +33-4 74 82 15 15
Télécopie: +33-4 74 94 10 51

Germany

GRUNDFOS Water Treatment GmbH
Reetzstraße 85
D-76327 Pfinztal (Söllingen)
Tel.: +49 7240 61-0
Telefax: +49 7240 61-177
E-mail: gwt@grundfos.com

Germany

GRUNDFOS GMBH
Schlüterstr. 33
40699 Erkrath
Tel.: +49-(0) 211 929 69-0
Telefax: +49-(0) 211 929 69-3799
E-mail: infoservice@grundfos.de
Service in Deutschland:
E-mail: kundendienst@grundfos.de

Greece

GRUNDFOS Hellas A.E.B.E.
20th km. Athinon-Markopoulou Av.
P.O. Box 71
GR-19002 Peania
Phone: +0030-210-66 83 400
Telefax: +0030-210-66 46 273

Hong Kong

GRUNDFOS Pumps (Hong Kong) Ltd.
Unit 1, Ground floor
Siu Wai Industrial Centre
29-33 Wing Hong Street &
68 King Lam Street, Cheung Sha Wan
Kowloon
Phone: +852-27861706 / 27861741
Telefax: +852-27858664

Hungary

GRUNDFOS Hungária Kft.
Tópark u. 8
H-2045 Törökbálint,
Phone: +36-23 511 110
Telefax: +36-23 511 111

India

GRUNDFOS Pumps India Private
Limited
118 Old Mahabalipuram Road
Thoraiappakkam
Chennai 600 097
Phone: +91-44 4596 6800

Indonesia

PT. GRUNDFOS POMPA
Graha Intirub Lt. 2 & 3
Jln. Cillilitan Besar No.454. Makasar,
Jakarta Timur
ID-Jakarta 13650
Phone: +62 21-469-51900
Telefax: +62 21-460 6910 / 460 6901

Ireland

GRUNDFOS (Ireland) Ltd.
Unit A, Merrywell Business Park
Ballymount Road Lower
Dublin 12
Phone: +353-1-4089 800
Telefax: +353-1-4089 830

Italy

GRUNDFOS Pompe Italia S.r.l.
Via Gran Sasso 4
I-20060 Truccazzano (Milano)
Tel.: +39-02-95838112
Telefax: +39-02-95309290 / 95838461

Japan

GRUNDFOS Pumps K.K.
1-2-3. Shin-Miyakoda, Kita-ku
Hamamatsu
431-2103 Japan
Phone: +81 53 428 4760
Telefax: +81 53 428 5005

Korea

GRUNDFOS Pumps Korea Ltd.
6th Floor, Aju Building 679-5
Yeoksam-dong, Kangnam-ku, 135-916
Seoul, Korea
Phone: +82-2-5317 600
Telefax: +82-2-5633 725

Latvia

SIA GRUNDFOS Pumps Latvia
Deglava biznesa centrs
Augusta Deglava ielā 60, LV-1035, Rīga,
Tālr.: + 371 714 9640, 7 149 641
Fakss: + 371 914 9646

Lithuania

GRUNDFOS Pumps UAB
Smolensko g. 6
LT-03201 Vilnius
Tel: + 370 52 395 430
Fax: + 370 52 395 431

Malaysia

GRUNDFOS Pumps Sdn. Bhd.
7 Jalan Peguam U1/25
Glenmarie Industrial Park
40150 Shah Alam
Selangor
Phone: +60-3-5569 2922
Telefax: +60-3-5569 2866

Mexico

Bombas GRUNDFOS de México S.A. de
C.V.
Boulevard TLC No. 15
Parque Industrial Stiva Aeropuerto
Apodaca, N.L. 66600
Phone: +52-81-8144 4000
Telefax: +52-81-8144 4010

Netherlands

GRUNDFOS Netherlands
Veluwezoom 35
1326 AE Almere
Postbus 22015
1302 CA ALMERE
Tel.: +31-88-478 6336
Telefax: +31-88-478 6332
E-mail: info_gnl@grundfos.com

New Zealand

GRUNDFOS Pumps NZ Ltd.
17 Beatrice Tinsley Crescent
North Harbour Industrial Estate
Albany, Auckland
Phone: +64-9-415 3240
Telefax: +64-9-415 3250

Norway

GRUNDFOS Pumper A/S
Strømsveien 344
Postboks 235, Leirdal
N-1011 Oslo
Tlf.: +47-22 90 47 00
Telefax: +47-22 32 21 50

Poland

GRUNDFOS Pompy Sp. z o.o.
ul. Klonowa 23
Baranowo k. Poznania
PL-62-081 Przeźmierowo
Tel: (+48-61) 650 13 00
Fax: (+48-61) 650 13 50

Portugal

Bombas GRUNDFOS Portugal, S.A.
Rua Calvet de Magalhães, 241
Apartado 1079
P-2770-153 Paço de Arcos
Tel.: +351-21-440 76 00
Telefax: +351-21-440 76 90

Romania

GRUNDFOS Pompe România SRL
Bd. Biruintei, nr 103
Pantelimon county Ilfov
Phone: +40 21 200 4100
Telefax: +40 21 200 4101
E-mail: romania@grundfos.ro

Russia

ООО Грундфос Россия
ул. Школьная, 39-41
Москва, RU-109544, Russia
Тел. (+7) 495 564-88-00 (495)
737-30-00
Факс (+7) 495 564 8811
E-mail grundfos.moscow@grundfos.com

Serbia

Grundfos Srbija d.o.o.
Omladinskih brigada 90b
11070 Novi Beograd
Phone: +381 11 2258 740
Telefax: +381 11 2281 769
www.rs.grundfos.com

Singapore

GRUNDFOS (Singapore) Pte. Ltd.
25 Jalan Tukang
Singapore 619264
Phone: +65-6681 9688
Telefax: +65-6681 9689

Slovakia

GRUNDFOS s.r.o.
Prievozská 4D
821 09 BRATISLAVA
Phona: +421 2 5020 1426
sk.grundfos.com

Slovenia

GRUNDFOS LJUBLJANA, d.o.o.
Leskoškova 9e, 1122 Ljubljana
Phone: +386 (0) 1 568 06 10
Telefax: +386 (0)1 568 0619
E-mail: tehnika-si@grundfos.com

South Africa

Grundfos (PTY) Ltd.
16 Lascelles Drive, Meadowbrook Estate
1609 Germiston, Johannesburg
Tel.: (+27) 10 248 6000
Fax: (+27) 10 248 6002
E-mail: Igradidge@grundfos.com

Spain

Bombas GRUNDFOS España S.A.
Camino de la Fuentequilla, s/n
E-28110 Algete (Madrid)
Tel.: +34-91-848 8800
Telefax: +34-91-628 0465

Sweden

GRUNDFOS AB
Box 333 (Lunnagårdsgatan 6)
431 24 Mölndal
Tel.: +46 31 332 23 000
Telefax: +46 31 331 94 60

Switzerland

GRUNDFOS Pumpen AG
Bruggacherstrasse 10
CH-8117 Fällanden/ZH
Tel.: +41-44-806 8111
Telefax: +41-44-806 8115

Taiwan

GRUNDFOS Pumps (Taiwan) Ltd.
7 Floor, 219 Min-Chuan Road
Taichung, Taiwan, R.O.C.
Phone: +886-4-2305 0868
Telefax: +886-4-2305 0878

Thailand

GRUNDFOS (Thailand) Ltd.
92 Chaloein Phrakiat Rama 9 Road,
Dokmai, Pravej, Bangkok 10250
Phone: +66-2-725 8999
Telefax: +66-2-725 8998

Turkey

GRUNDFOS POMPA San. ve Tic. Ltd.
Sti.
Gebze Organize Sanayi Bölgesi
İhsan dede Caddesi,
2. yol 200. Sokak No. 204
41490 Gebze/Kocaeli
Phone: +90 - 262-679 7979
Telefax: +90 - 262-679 7905
E-mail: satis@grundfos.com

Ukraine

Бізнес Центр Європа
Столичне шосе, 103
м. Київ, 03131, Україна
Телефон: (+38 044) 237 04 00
Факс.: (+38 044) 237 04 01
E-mail: ukraine@grundfos.com

United Arab Emirates

GRUNDFOS Gulf Distribution
P.O. Box 16768
Jebel Ali Free Zone
Dubai
Phone: +971-4- 8815 166
Telefax: +971-4-8815 136

United Kingdom

GRUNDFOS Pumps Ltd.
Grovebury Road
Leighton Buzzard/Beds. LU7 4TL
Phone: +44-1525-850000
Telefax: +44-1525-850011

U.S.A.

GRUNDFOS Pumps Corporation
9300 Loiret Blvd.
Lenexa, Kansas 66219
Phone: +1-913-227-3400
Telefax: +1-913-227-3500

Uzbekistan

Grundfos Tashkent, Uzbekistan The
Representative Office of Grundfos
Kazakhstan in Uzbekistan
38a, Oybek street, Tashkent
Телефон: (+998) 71 150 3290 / 71 150
3291
Факс: (+998) 71 150 3292

Addresses revised 31.03.2020

95724708 0520

ECM: 1285312

Trademarks displayed in this material, including but not limited to Grundfos, the Grundfos logo and "be think innovate" are registered trademarks owned by The Grundfos Group. All rights reserved. © 2020 Grundfos Holding A/S, all rights reserved.