

NB, NBE, NK, NKE

Single-stage end-suction pumps according to EN 733
50 Hz



be
think
innovate

GRUNDFOS 

1. Applications	5
Introduction	5
Water supply	5
Industrial pressure boosting	5
Industrial liquid transfer	5
HVAC	5
Irrigation	5
2. Features and benefits	6
3. Performance range	8
NB, 2-pole	8
NK, 2-pole	9
NB, 4-pole	10
NK, 4-pole	11
NB, 6-pole	12
NK, 6-pole	13
4. Product range	14
NB, NK, 2-pole	14
NB, NK, 4-pole	18
NB, NK, 6-pole	23
E-pumps	25
5. Identification	26
Nameplate	26
Type key, NB, NBE	26
Type key, NK, NKE	28
Shaft seals	31
Stuffing boxes, NK	31
6. Construction	32
NB, centre-line outlet	32
NB, tangential outlet	32
NK, centre-line outlet	34
NK, tangential outlet	34
NK, stuffing box	35
Mechanical construction	38
Surface treatment	41
Test pressure	41
Motors and drives	42
7. Operating conditions	45
Pump location	45
Ambient temperature and installation altitude	45
Flow rates	46
Sound pressure level	47
Liquid temperatures	47
Operating range of mechanical shaft seals	48
Recommended shaft seal for water-glycol mixture	49
Operating range of stuffing boxes	50
Pressures in the pump	50
8. Mechanical installation	52
Foundation and grouting	52
Pipes	53
Condensation cover	54
Elimination of noise and vibrations	54
Alignment	55
9. Speed-controlled pumps	56
Maximum speed of the impeller	57
Affinity equations	58
Communication with the E-solution	59
Communication with E-pumps	60

10. Pumps connected in parallel	61
Control of pumps connected in parallel	61
Pumps connected to Control MPC.	61
11. Selection of product	62
Key application data sheet.	62
Pump size	63
Efficiency	63
Material	63
Motor size	63
12. Pumped liquids	64
General recommendations.	64
"Liquids" in Grundfos Product Center	64
13. NK bare-shaft pumps	65
NK, centre-line outlet	65
NK, tangential outlet.	66
14. Pump flange dimensions	67
Fixed pump flanges, EN 1092-2	67
Fixed pump flanges, AS2129 table E.	67
Fixed pump flanges, EN 1092-1	67
Loose pump flanges, EN 1092-1	68
Loose pump flanges, ASME B16.5	68
Loose pump flanges, JIS B 2220	68
15. Introduction to curves and technical data	69
How to read the curve charts	69
Curve conditions	70
Pump performance testing.	71
Performance-test types for end-suction pumps	72
Specifying acceptance grades	75
16. Performance curves	77
Overview	77
2-pole	78
4-pole	96
6-pole	121
17. Dimensional drawings and technical data	132
Dimensional drawings, NB.	132
Technical data, NB.	133
Dimensional drawings, NK.	141
Technical data, NK.	142
Dimensional drawing, NBE, NKE Series 2000.	150
Technical data, NBE, NKE Series 2000.	150
18. Minimum efficiency index	151
19. Base frames	152
NK base frames	152
NK with EN/ISO base frames, dimensional sketches	153
NK with C-channel base frames, dimensional sketches	154
NK pump dimensions with C-channel base frames	157
NB base frames	166
NB base frames, dimensional sketches.	166
NB pump dimensions as per motor type	167
NB base frames, product numbers	175
20. Motor data	177
Standard motor range	177
MGE motor range	177
Electrical data, IE1 motors.	178
Electrical data, IE2 motors.	178

Electrical data, IE3 motors	183
Electrical data, MGE motors	189
Pump dimensions with other motors	190
21. Accessories	200
Counter-flanges	200
Sensors	204
External Grundfos sensors	205
Potentiometer	206
Grundfos GO	206
CIU communication interface units	207
CIM communication interface modules	207
Antennas and battery	207
EMC filter	208
Shims	208
Support blocks, NB	209
Certificates and reports	218
22. Service	219
23. Grundfos Product Center	220

1. Applications

Introduction

NB and NK are multipurpose pumps suitable for a variety of different applications demanding reliable and cost-efficient supply.

NB and NK pumps are used in five main fields of application:

- water supply
- industrial pressure boosting
- industrial liquid transfer
- HVAC
- irrigation.

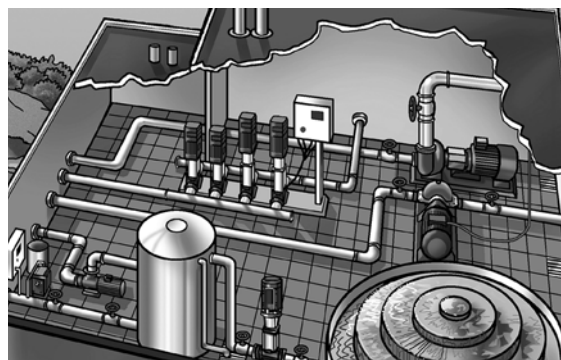

TM03 0146 4204

Water supply

Besides general water supply in municipal and industrial waterworks, the NB and NK pumps are used for these specific applications:

- filtration and transfer at waterworks
- pressure boosting in mains
- pressure boosting in high-rise buildings, hotels, etc.
- pressure boosting in industrial buildings
- various swimming bath applications.

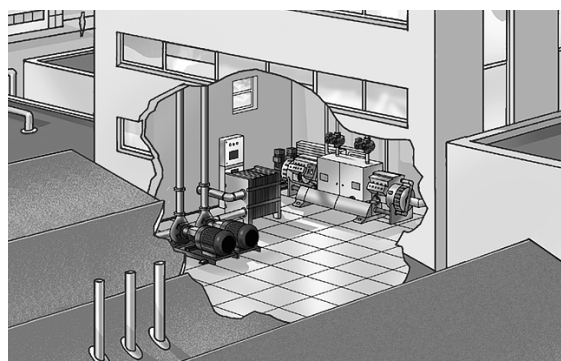

TM03 0147 4204

Industrial pressure boosting

Pressure boosting in these applications:

- industrial washing and cleaning systems
- industrial wash-down systems
- vehicle washing tunnels
- fire-fighting systems.



TM03 0148 4204

Industrial liquid transfer

Liquid transfer in these applications:

- cooling and air-conditioning systems, refrigerants
- boiler-feed and condensate systems
- aquafarming
- industrial heating systems
- district heating plants.

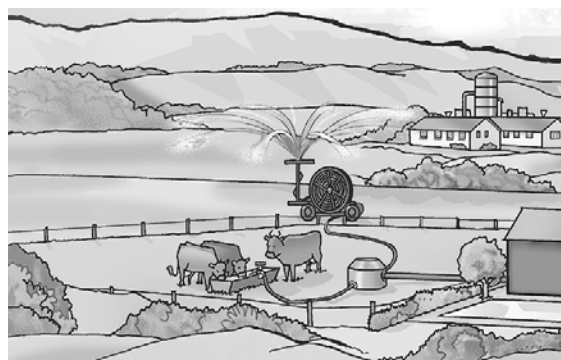

TM03 0149 4204

HVAC

Liquid transfer in these applications:

- heating systems
- ventilation systems
- air-conditioning systems.

Irrigation

Irrigation covers these applications:

- field irrigation, flooding
- sprinkler irrigation
- drip-feed irrigation.

2. Features and benefits

NB and NK pumps offer the following features and benefits:

- The pumps are non-self-priming, single-stage, centrifugal volute pumps with axial inlet port, radial outlet port and horizontal shaft.
- All pumps are according to ISO 5199.
- Inlet and outlet flanges are according to EN 1092-2.
- Dimensions and rated performance are according to EN 733 (10 bar).
However, pumps with flange dimensions up to and including DN 150 are marked PN 16 and thus suitable for 16 bar operation.
- The mechanical shaft seal has dimensions according to EN 12756.
- The pumps offer flow rates from 2 to 1300 m³/h and heads from 2 to 160 m.
- The pumps can be equipped with an MGE motor with integrated frequency converter or connected to a Grundfos CUE external frequency converter.
- All pumps are statically balanced according to ISO 1940-1 class 6.3.
Impellers are hydraulically balanced.



Fig. 1 NB pump

GrA2519



Fig. 2 NK pump

GrA2514

- For NB pumps the back pull-out design enables removal of the motor, motor stool and impeller without disturbing the pump housing or pipes. Even the largest pumps can thus be serviced by a single person with a crane.

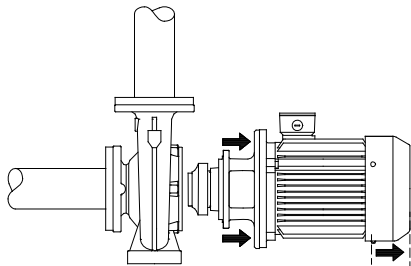

Fig. 3 NB back pull-out design

TM02 9512 2804

- For NK pumps the back pull-out design enables removal of the motor, motor stool and impeller without disturbing the pump housing or pipes. Even the largest pumps can thus be serviced by a single person with a crane.

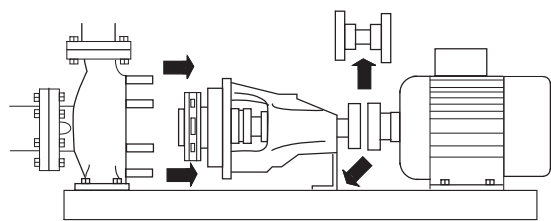

Fig. 4 NK back pull-out design

TM03 1004 0905

- The NB pump is close-coupled with a totally enclosed fan-cooled standard motor with main dimensions to IEC and DIN standards.
- For most of the NB pumps, a Grundfos-designed base frame is available. For more information, see [NB base frames](#) on page 166.

- The NK pump is long-coupled with a totally enclosed fan-cooled standard motor with main dimensions to IEC and DIN standards and mounting designation B3 (IM 1001).

Pumps with standard motors

IE1 IE2 IE3 IE4

NB and NK pumps are fitted with standard motors with efficiency classes IE1, IE2 and IE3 for low-voltage three-phase motors.

IE4 motors are available on request.

The IE3 premium efficiency motors have a higher efficiency level than IE2 high efficiency and IE1 standard efficiency motors.

Pumps with electronic speed control

IE2 IE3 IE5

NBE and NKE pumps are NB and NK pumps equipped with a motor with built-in frequency converter and the necessary application software to achieve an all-in-one solution enabling electronic speed control.

Electronic speed control enables continuously variable control of motor speed which again enables adaptation of the performance to a given requirement.

If a sensor is installed, NBE and NKE pumps allow for any of these configurations and control methods:

- constant pressure
- temperature control
- constant flow.

NBE, NKE pumps with 2-pole motors up to 11 kW and 4-pole motors up to 7.5 kW are fitted with Grundfos permanent-magnet MGE motors that have motor efficiency class IE5 according to IEC 60034-30-2.

Why select an NBE, NKE pump?

A pump with electronic speed control offers these benefits:

- energy savings
- increased comfort
- control and monitoring of pump performance
- communication with the pump.

For further information on electronic speed control, see section [9. Speed-controlled pumps](#).

Energy-optimised pumps

NB, NK pumps are energy-optimised and comply with the EuP Directive, Commission Regulation (EC) No 547/2012, in which most pumps are classified or graduated in an energy efficiency index (MEI). See also section [18. Minimum efficiency index](#).

ATEX-approved pumps

On request, Grundfos offers NB and NK pumps with ATEX-approval in accordance with Directive 94/9/EC, group II, category 2G/D and 3G/D. For more information on ATEX-approved pumps, see the data booklet "NB, NBG, NK, NKG, NBE, NBGE, NKE, NKGE - Custom-built pumps according to EN 733 and ISO 2858".

3. Performance range

NB, 2-pole

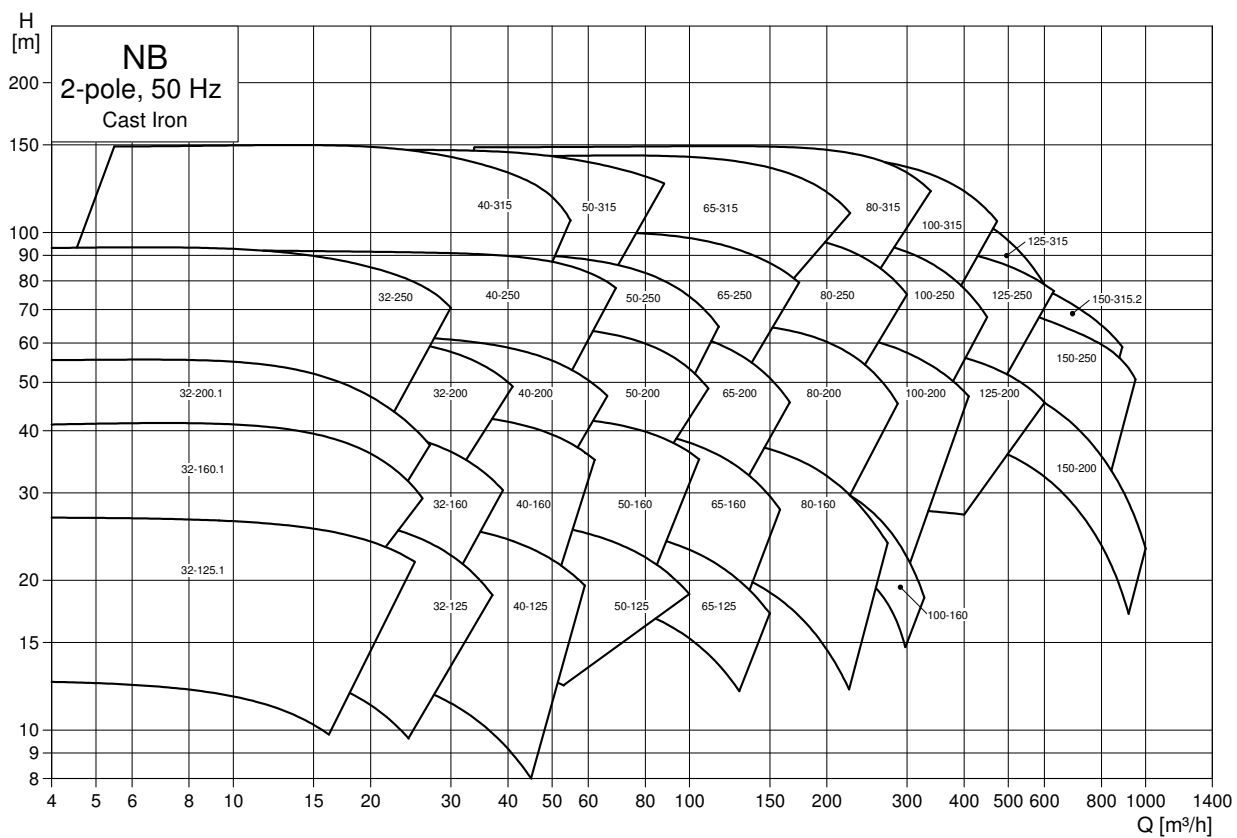

TM05 1049 1418

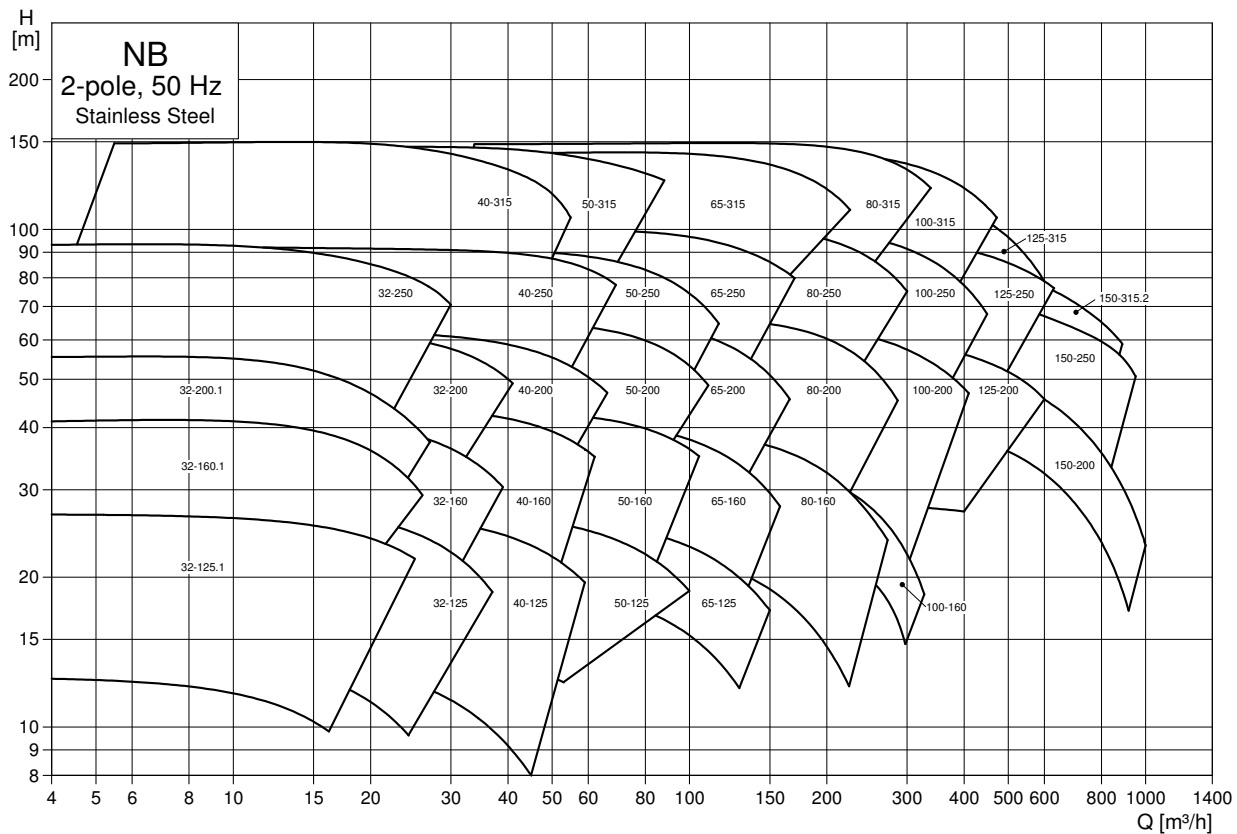

TM05 1051 1418

NK, 2-pole

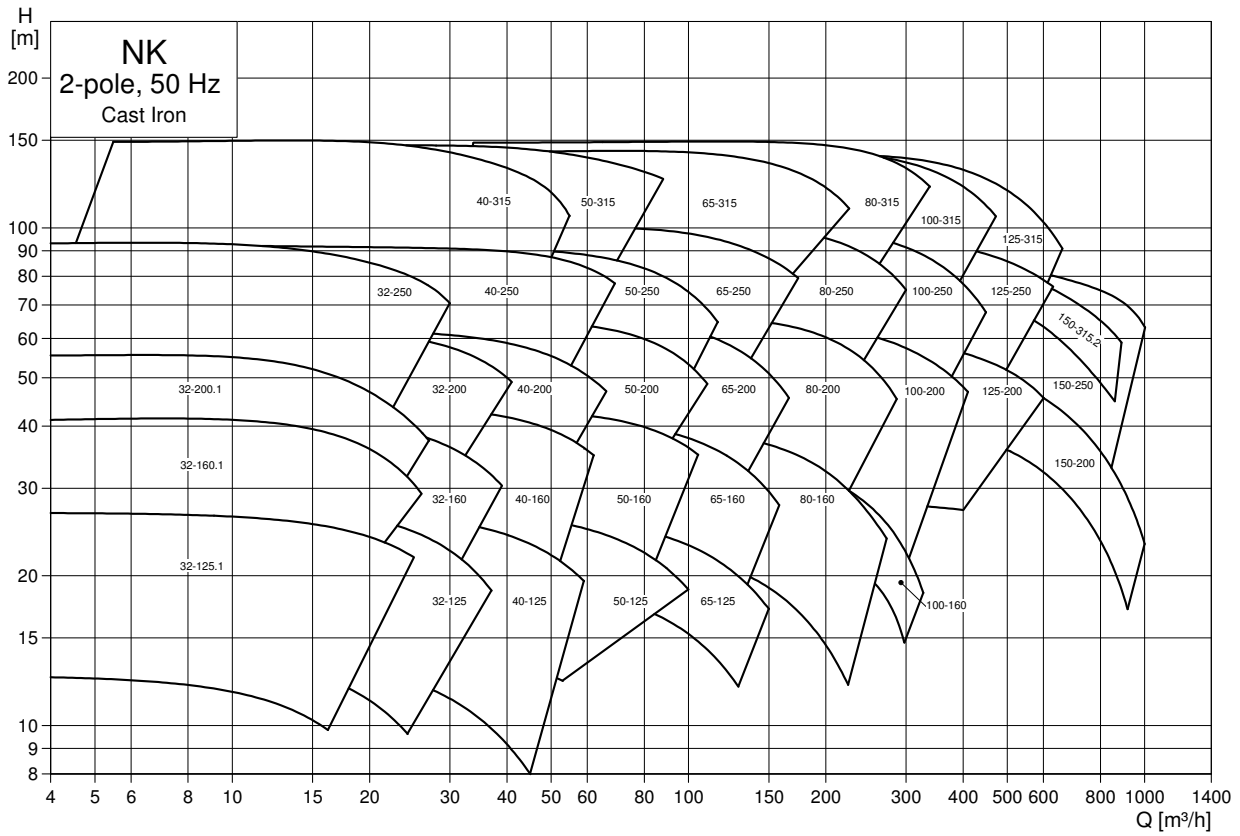

TM05 1048 1418

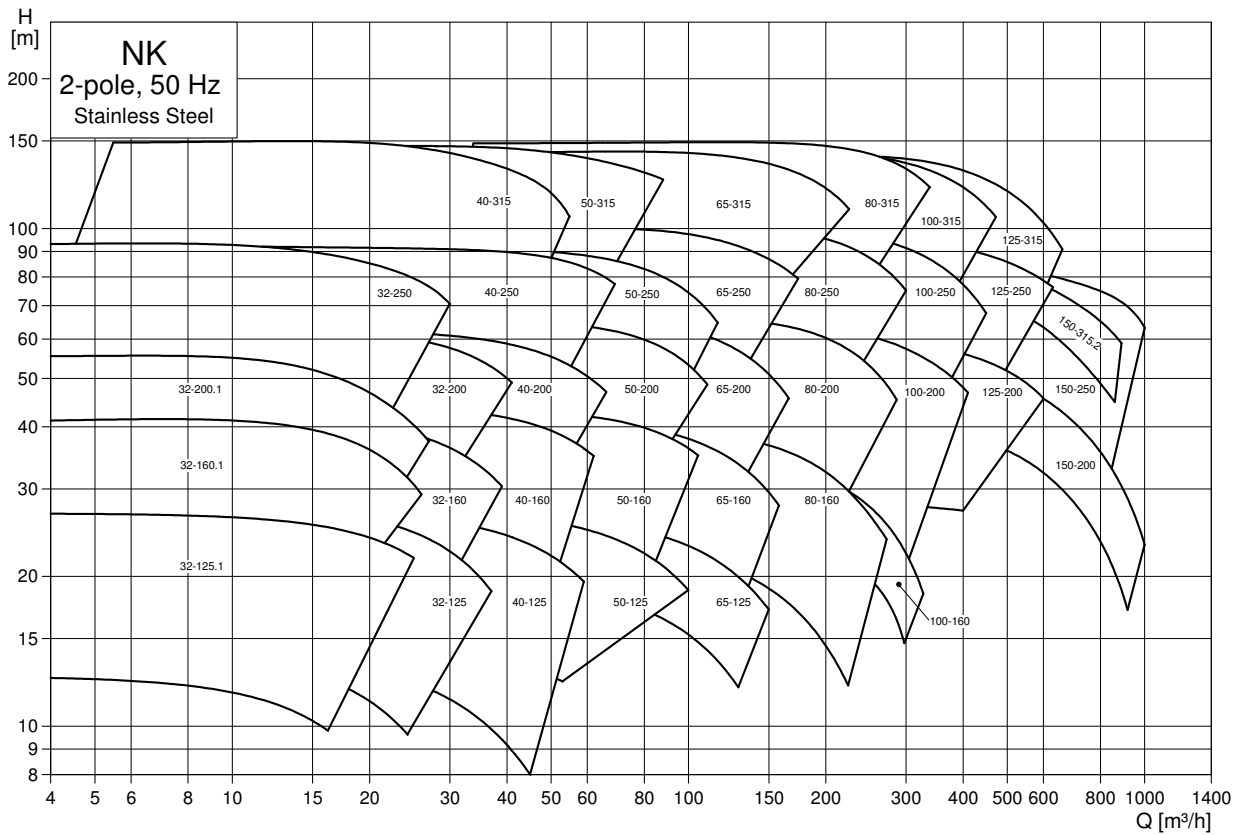

TM05 1050 1418

NB, 4-pole

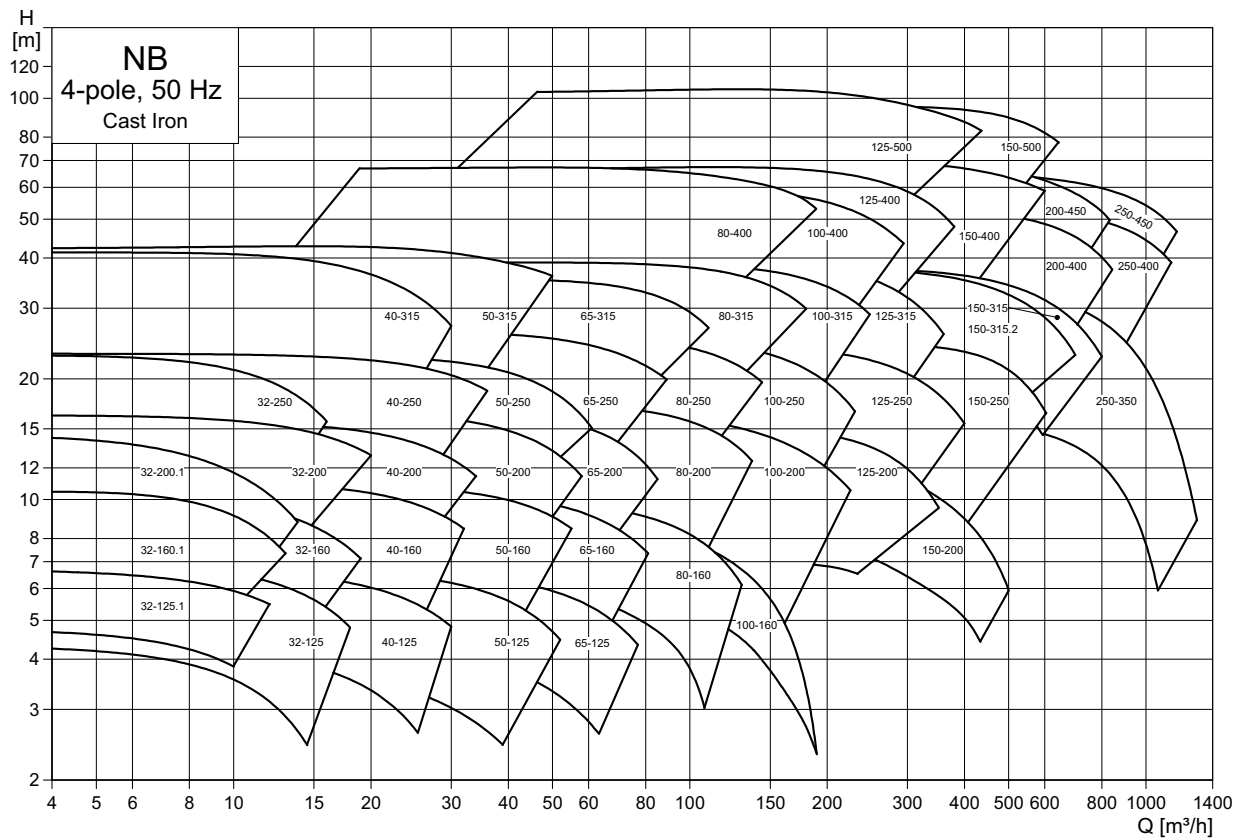

TM05 1053 2316

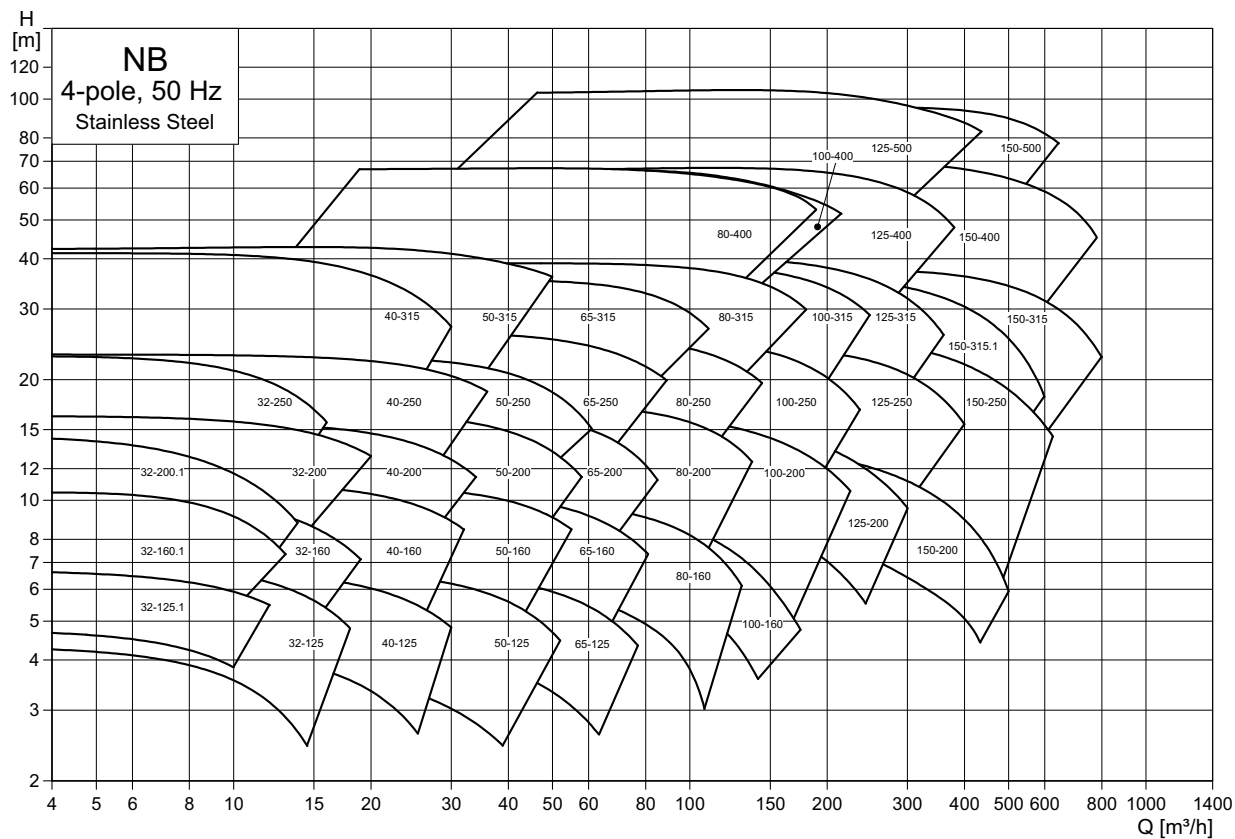

TM06 7430 3316

NK, 4-pole

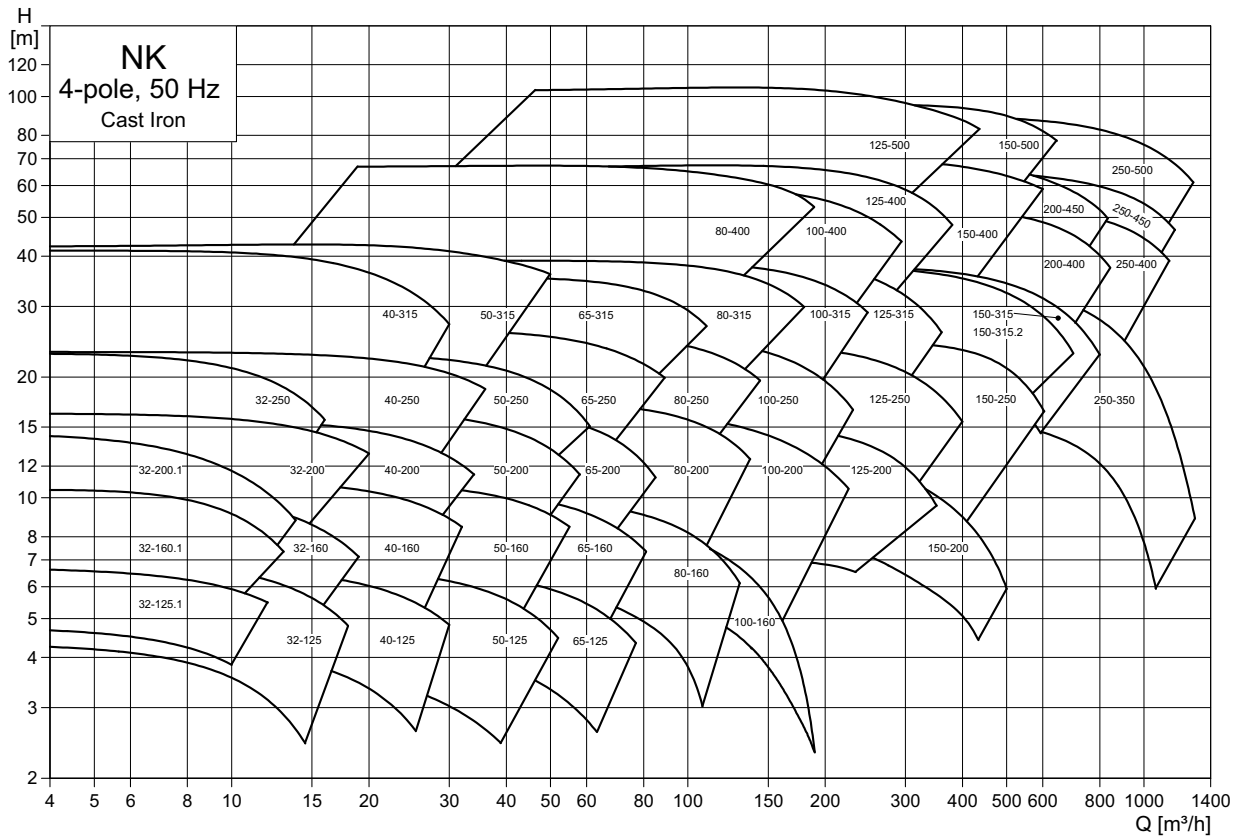

TM05 1052 2316

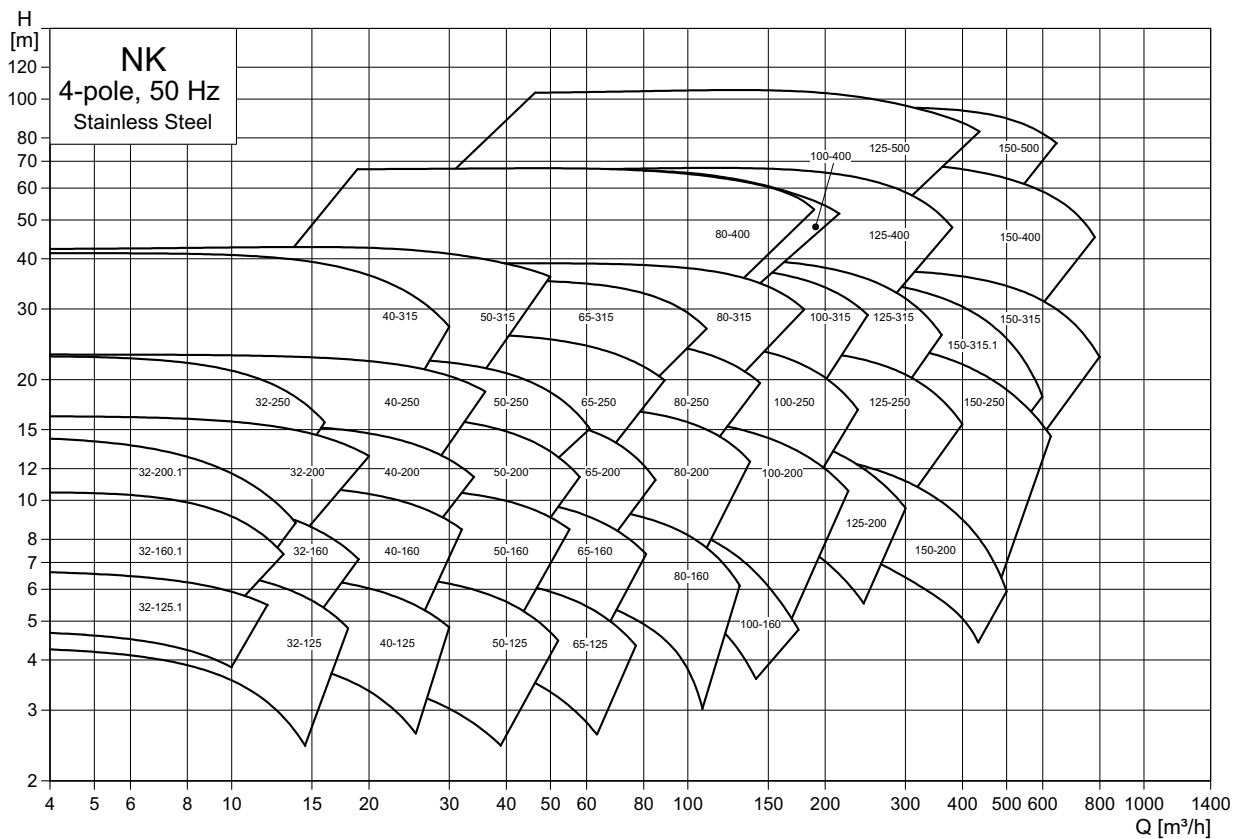

TM06 7431 3316

NB, 6-pole

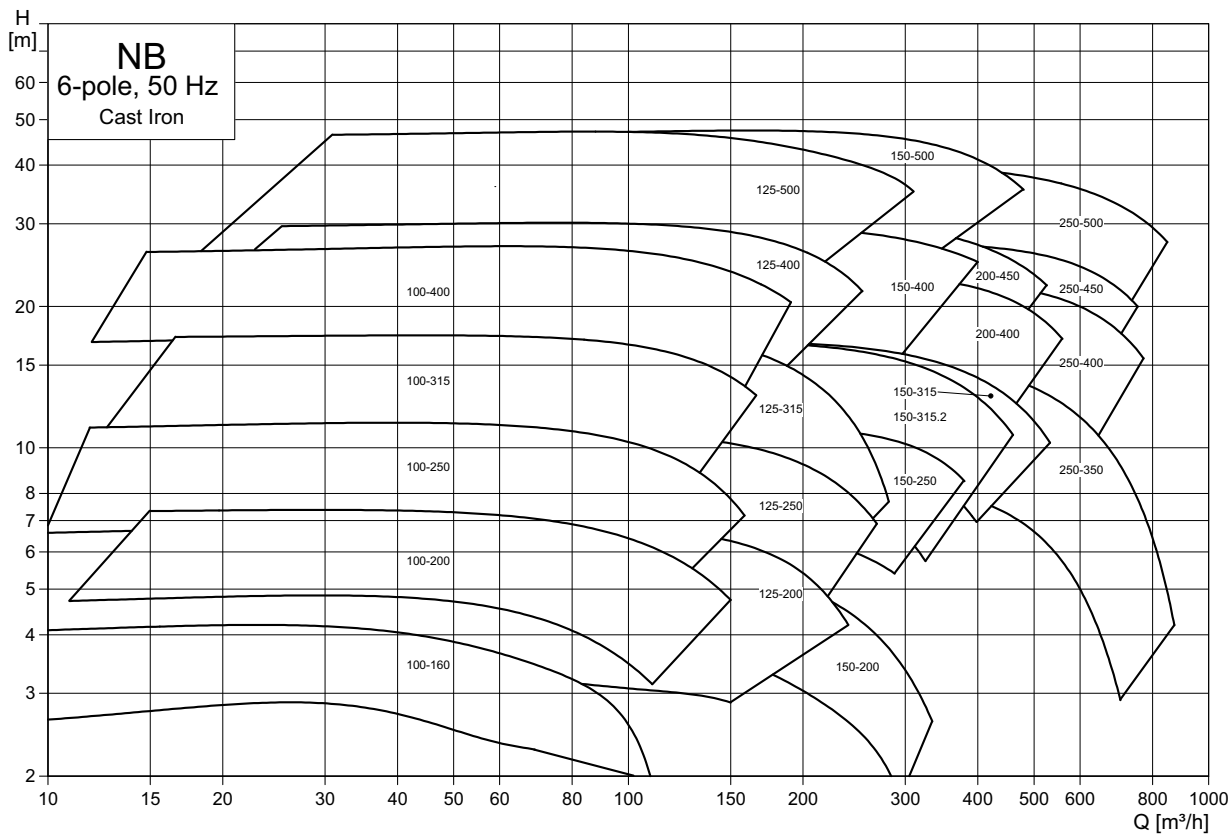

TM05 1057 2316

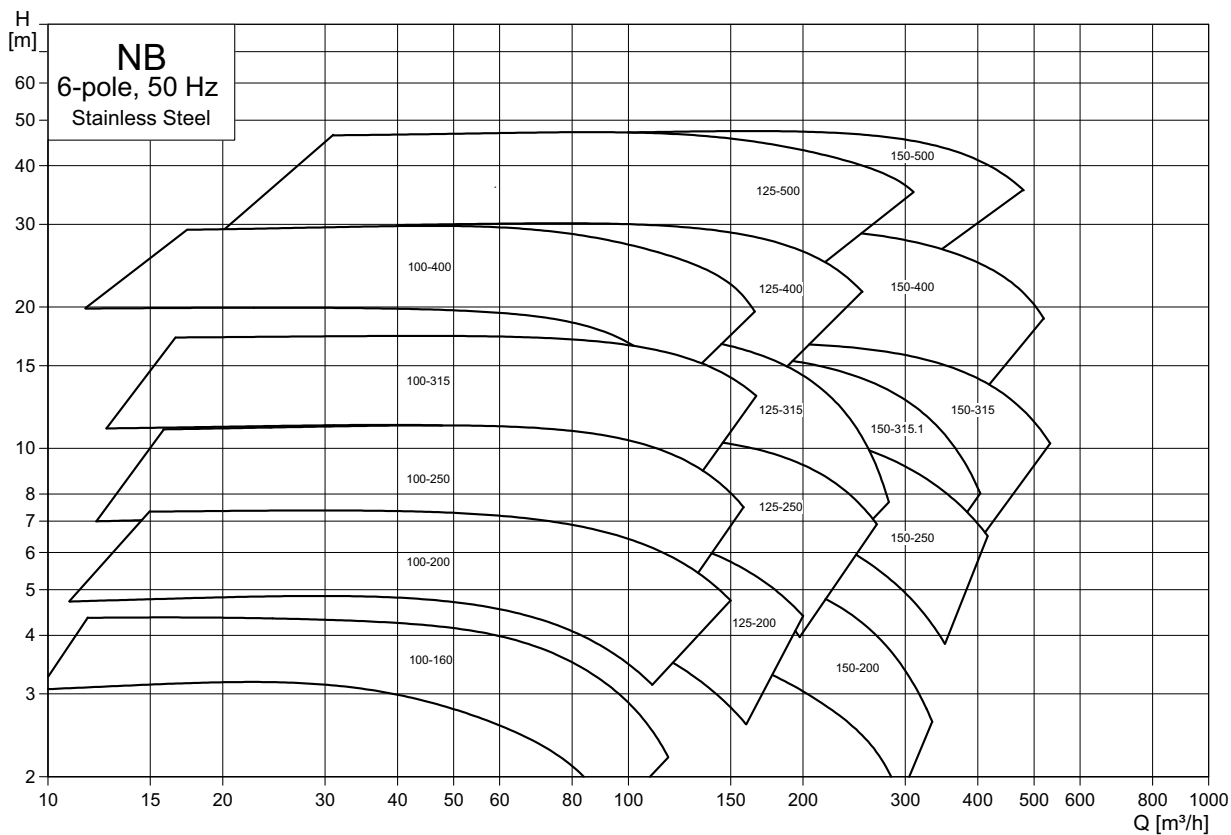

TM06 7432 3316

NK, 6-pole

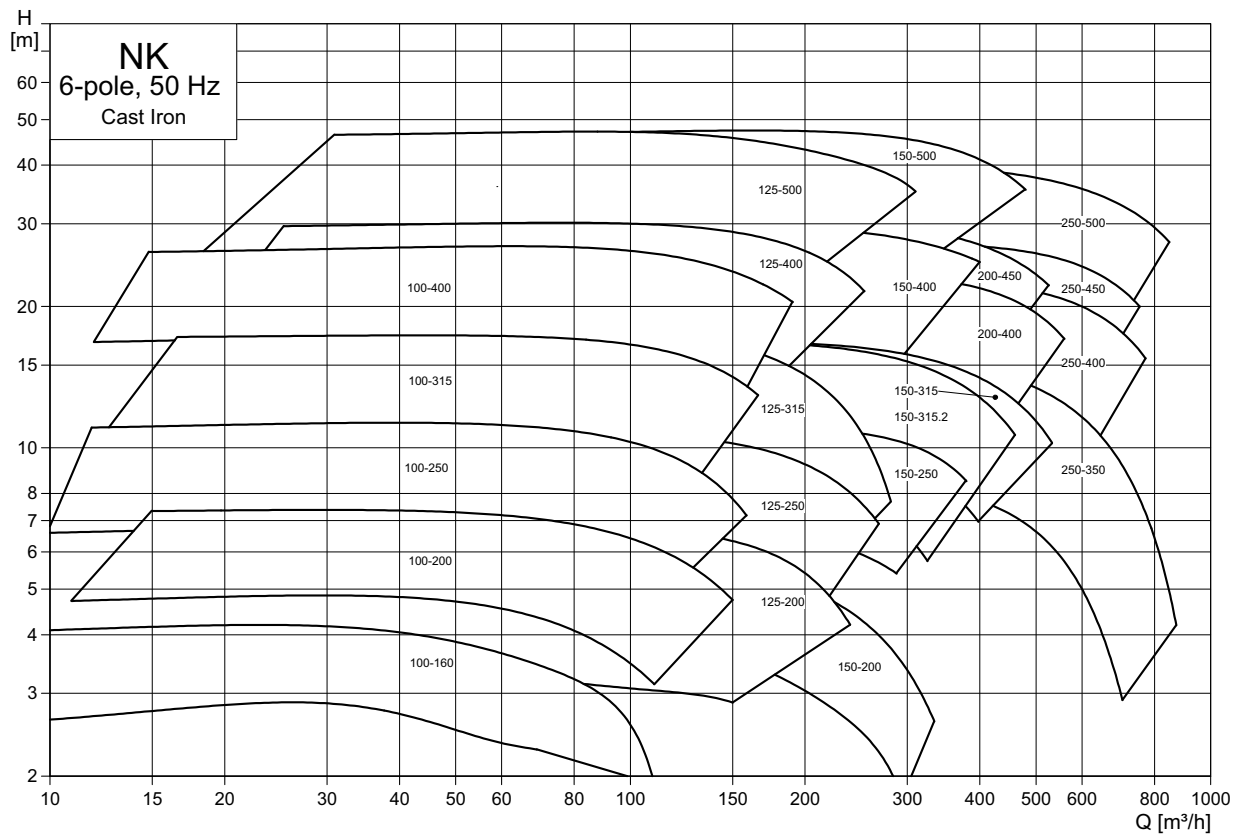

TM05 1056 2316

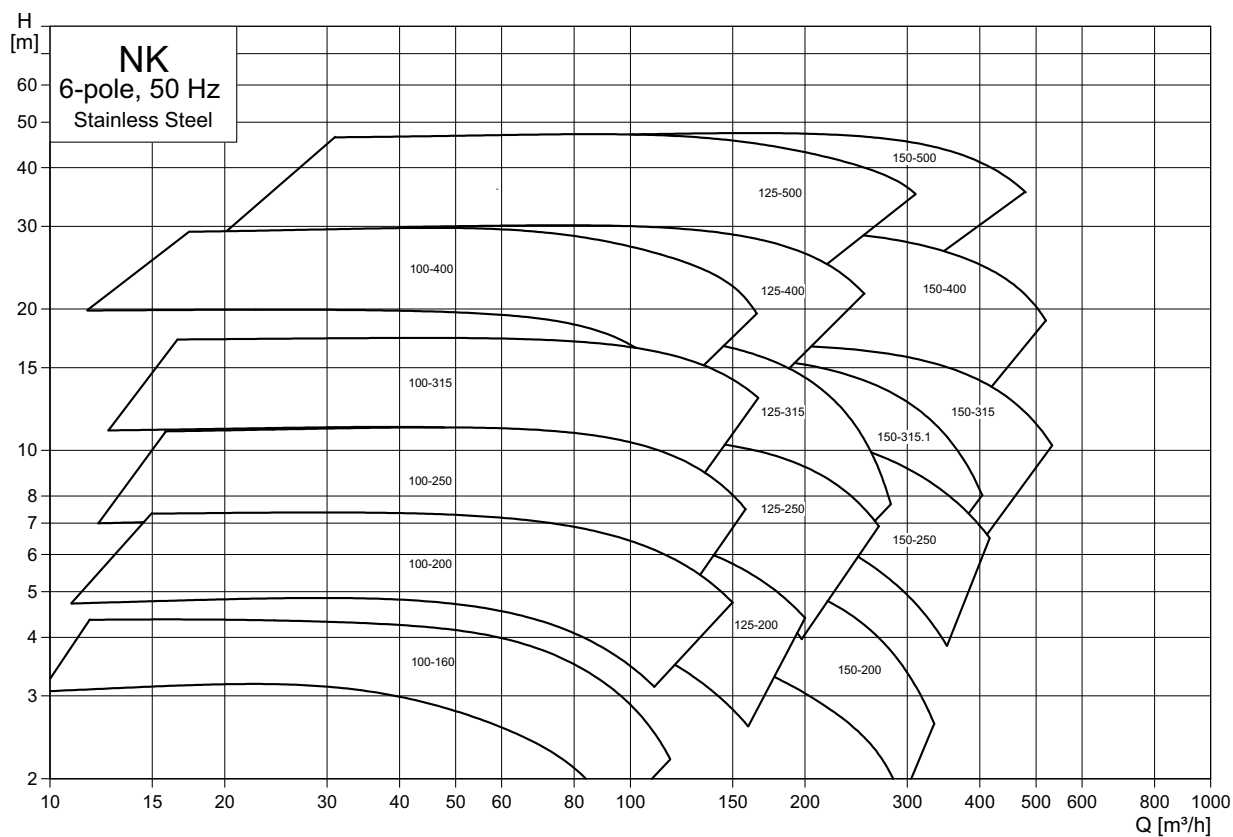

TM06 7433 3316

4. Product range

The tables on the following pages show the complete product ranges of NB, NBE and NK, NKE pumps. The standard range has been combined on the basis of the following parameters:

Pump

- Pump housings have outlet flanges from DN 32 to DN 250.
- Some stainless steel pump sizes have loose flanges. All others have fixed flanges.
- NB pumps are available in mounting design A, B, C and F. The base frame for C is available as accessory. F has base frame. For further information, see [Mechanical construction](#) on page 38.
- Support blocks: NB, NBG pumps combine with many motor frame sizes. In some cases, support blocks or support rails are needed in order to level out the height difference between pump and motor. Also the size of the motor flange may necessitate the use of supports. See [Support blocks, NB](#) on page 209. The Grundfos Product Configuration System makes it possible to configure the NB, NBG pump and the supports, if needed.

Motor

- Motors are for 50 Hz.
- NB and NK pumps are available with 2-, 4- and 6-pole motors; NBE and NKE with 2- and 4-pole motors.
- NB and NK pumps are available with IE2 and IE3 motors; for some regions also IE1 motors.
- Motors with power rating up to and including 4 kW are available for "low voltage"; motors as from 2.2 kW are available for "high voltage".
- Some pumps can be equipped with an MGE motor with integrated frequency converter.
- Some pumps can be connected to a Grundfos CUE external frequency converter.
- All pumps with non-E-motor can be connected to an external frequency converter.

Custom-built pumps

See the data booklet "NB, NBG, NK, NKG, NBE, NBGE, NKE, NKGE - Custom-built pumps according to EN 733 and ISO 2858", or contact Grundfos.

NB, NK, 2-pole

50 Hz, 2-pole		NB pumps				NK pumps				Cast iron pump		Stainless steel pump		Shaft seal diameter [mm]
Pump type	P ₂ [kW]	E-solution	Oversize shaft	Mounting design ¹	Material code	Options	Material code	Options	Flange rating ²	Flange standard	Flange rating ²	Flange standard		
					A, B, C, D, S, T E, F, G, H K, M N, P I, J, L, R, U, W	Double seal arrangement Cartridge seal, single or double Pump housing with feet Pump with base frame	A, B, C, D, S, T E, F, G, H K, M N, P I, J, L, R, U, W	Double seal arrangement Cartridge seal, single or double Standard bearing bracket Heavy-duty bearing bracket	PN 10 PN 16 DIN, code F ANSI, code G JIS, code J	PN 10 PN 16 DIN, code F ANSI, code G JIS, code J	d5 [mm]			
32-125.1	0.75	CUE	-	A	•	-	•	-	F	F	•	-	24	28
	1.1	MGE	-	A	•	-	•	-	F	F	•	-	24	28
	1.5	MGE	-	A	•	-	•	-	F	F	•	-	24	28
32-125	2.2	MGE	-	A	•	-	•	-	F	F	•	-	24	28
	1.1	MGE	-	A	•	-	•	-	F	F	•	-	24	28
	1.5	MGE	-	A	•	-	•	-	F	F	•	-	24	28
32-160.1	2.2	MGE	-	A	•	-	•	-	F	F	•	-	24	28
	3	MGE	-	A	•	-	•	-	F	F	•	-	24	28
	1.5	MGE	-	A	•	-	•	-	F	F	•	-	24	28
32-160	2.2	MGE	-	A	•	-	•	-	F	F	•	-	24	28
	3	MGE	-	A	•	-	•	-	F	F	•	-	24	28
	4	MGE	-	A	•	-	•	-	F	F	•	-	24	28
32-200.1	2.2	MGE	-	A	•	-	•	-	F	F	•	-	24	28
	5.5	MGE	-	A	•	-	•	-	F	F	•	-	24	28
	3	MGE	-	A	•	-	•	-	F	F	•	-	24	28
	4	MGE	-	A	•	-	•	-	F	F	•	-	24	28
	5.5	MGE	-	A	•	-	•	-	F	F	•	-	24	28
	7.5	MGE	-	A	•	-	•	-	F	F	•	-	24	28

50 Hz, 2-pole				NB pumps		NK pumps		Cast iron pump		Stainless steel pump		Shaft seal diameter [mm]	
Pump type	P2 [kW]	E-solution	Oversize shaft	Mounting design ¹	Material code	Options	Material code	Options	Flange rating ²	Flange standard	Flange rating ²		Flange standard
					A, B, C, D, S, T E, F, G, H K, M N, P I, J, L, R, U, W	Double seal arrangement Cartridge seal, single or double Pump housing with feet Pump with base frame	A, B, C, D, S, T E, F, G, H K, M N, P I, J, L, R, U, W	Stuffing box Double seal arrangement Cartridge seal, single or double Standard bearing bracket Heavy-duty bearing bracket	PN 10 PN 16 DIN, code F ANSI, code G JIS, code J	PN 10 PN 16 DIN, code F ANSI, code G JIS, code J			
32-200	4	MGE	-	A	•	-	•	-	F	F	•		-
	5.5	MGE	-	A	•	-	•	-	F	F	•	-	24 28
	7.5	MGE	-	A	•	-	•	-	F	F	•	-	24 28
	11	MGE	-	C	•	-	•	-	F	F	•	-	24 28
32-250	5.5	MGE	-	A	•	-	•	-	F	F	•	-	24 28
	7.5	MGE	-	A	•	-	•	-	F	F	•	-	24 28
	11	MGE	-	C	•	-	•	-	F	F	•	-	24 28
	15	MGE	-	C	•	-	•	-	F	F	•	-	24 28
40-125	1.5	MGE	-	A	•	-	•	-	F	F	•	-	24 28
	2.2	MGE	-	A	•	-	•	-	F	F	•	-	24 28
	3	MGE	-	A	•	-	•	-	F	F	•	-	24 28
	4	MGE	-	A	•	-	•	-	F	F	•	-	24 28
40-160	5.5	MGE	-	A	•	-	•	-	F	F	•	-	24 28
	4	MGE	-	A	•	-	•	-	F	F	•	-	24 28
	5.5	MGE	-	A	•	-	•	-	F	F	•	-	24 28
	7.5	MGE	-	A	•	-	•	-	F	F	•	-	24 28
40-200	11	MGE	-	C	•	-	•	-	F	F	•	-	24 28
	5.5	MGE	-	A	•	-	•	-	F	F	•	-	24 28
	7.5	MGE	-	A	•	-	•	-	F	F	•	-	24 28
	11	MGE	-	B	•	-	•	-	F	F	•	-	24 28
40-250	15	MGE	-	B	•	-	•	-	F	F	•	-	24 28
	11	MGE	-	B	•	-	•	-	F	F	•	-	24 28
	15	MGE	-	B	•	-	•	-	F	F	•	-	24 28
	18.5	MGE	-	B	•	-	•	-	F	F	•	-	24 28
40-315	22	MGE	-	B	•	-	•	-	F	F	•	-	24 28
	30	CUE	-	B	•	-	•	-	F	F	•	-	24 28
	22	MGE	-	C	•	-	•	-	F	F	•	-	32 38
	30	CUE	-	C	•	-	•	-	F	F	•	-	32 38
50-125	37	CUE	-	C	•	-	•	-	F	F	•	-	32 38
	45	CUE	-	C	•	-	•	-	F	F	•	-	32 38
	3	MGE	-	A	•	-	•	-	F	F	•	-	24 28
	4	MGE	-	A	•	-	•	-	F	F	•	-	24 28
50-160	5.5	MGE	-	A	•	-	•	-	F	F	•	-	24 28
	7.5	MGE	-	A	•	-	•	-	F	F	•	-	24 28
	5.5	MGE	-	A	•	-	•	-	F	F	•	-	24 28
	7.5	MGE	-	A	•	-	•	-	F	F	•	-	24 28
50-200	11	MGE	-	B	•	-	•	-	F	F	•	-	24 28
	15	MGE	-	B	•	-	•	-	F	F	•	-	24 28
	11	MGE	-	B	•	-	•	-	F	F	•	-	24 28
	15	MGE	-	B	•	-	•	-	F	F	•	-	24 28
50-250	18.5	MGE	-	B	•	-	•	-	F	F	•	-	24 28
	22	MGE	-	B	•	-	•	-	F	F	•	-	24 28
	15	MGE	-	B	•	-	•	-	F	F	•	-	24 28
	18.5	MGE	-	B	•	-	•	-	F	F	•	-	24 28
50-315	22	MGE	-	B	•	-	•	-	F	F	•	-	24 28
	30	CUE	-	B	•	-	•	-	F	F	•	-	24 28
	37	CUE	-	B	•	-	•	-	F	F	•	-	24 28
	30	CUE	-	C	•	-	•	-	F	F	•	-	32 38
65-125	37	CUE	-	C	•	-	•	-	F	F	•	-	32 38
	45	CUE	-	C	•	-	•	-	F	F	•	-	32 38
	55	CUE	-	C	•	-	•	-	F	F	•	-	32 38
	4	MGE	-	A	•	-	•	-	F	F	•	-	24 28
65-125	5.5	MGE	-	A	•	-	•	-	F	F	•	-	24 28
	7.5	MGE	-	A	•	-	•	-	F	F	•	-	24 28
	11	MGE	-	C	•	-	•	-	F	F	•	-	24 28

50 Hz, 2-pole				NB pumps				NK pumps				Cast iron pump		Stainless steel pump		d5 [mm]	Shaft seal diameter [mm]
Pump type	P2 [kW]	E-solution	Oversize shaft	Material code		Options		Material code		Options		Flange rating ²	Flange standard	Flange rating ²	Flange standard		
				A, B, C, D, S, T E, F, G, H	K, M N, P I, J, L, R, U, W	Double seal arrangement Cartridge seal, single or double Pump housing with feet Pump with base frame	A, B, C, D, S, T E, F, G, H	K, M N, P I, J, L, R, U, W	Stuffing box Double seal arrangement Cartridge seal, single or double Standard bearing bracket Heavy-duty bearing bracket	PN 10 PN 16	DIN, code F ANSI, code G JIS, code J	PN 10 PN 16	DIN, code F ANSI, code G JIS, code J				
														Mounting design ¹			
65-160	7.5	MGE	-	A	•	•	•	•	•	•	•	F	F	•	•	24	28
	11	MGE	-	B	•	•	•	•	•	•	•	F	F	•	•	24	28
	15	MGE	-	B	•	•	•	•	•	•	•	F	F	•	•	24	28
	18.5	MGE	-	B	•	•	•	•	•	•	•	F	F	•	•	24	28
65-200	11	MGE	-	B	•	•	•	•	•	•	•	F	F	•	•	24	28
	15	MGE	-	B	•	•	•	•	•	•	•	F	F	•	•	24	28
	18.5	MGE	-	B	•	•	•	•	•	•	•	F	F	•	•	24	28
	22	MGE	-	B	•	•	•	•	•	•	•	F	F	•	•	24	28
65-250	30	CUE	-	B	•	•	•	•	•	•	•	F	F	•	•	24	28
	37	CUE	-	B	•	•	•	•	•	•	•	F	F	•	•	24	28
	30	CUE	-	C	•	•	•	•	•	•	•	F	F	•	•	32	38
	37	CUE	-	C	•	•	•	•	•	•	•	F	F	•	•	32	38
65-315	45	CUE	-	C	•	•	•	•	•	•	•	F	F	•	•	32	38
	55	CUE	-	C	•	•	•	•	•	•	•	F	F	•	•	32	38
	75	CUE	-	C	•	•	•	•	•	•	•	F	F	•	•	32	38
	55	CUE	-	C	•	•	•	•	•	•	•	F	F	•	•	32	38
80-160	75	CUE	-	C	•	•	•	•	•	•	•	F	F	•	•	32	38
	90	CUE	-	C	•	•	•	•	•	•	•	F	F	•	•	32	38
	110	CUE	-	C	•	•	•	•	•	•	•	F	F	•	•	32	38
	11	MGE	-	B	•	•	•	•	•	•	•	F	F	•	•	24	28
80-200	15	MGE	-	B	•	•	•	•	•	•	•	F	F	•	•	24	28
	18.5	MGE	-	B	•	•	•	•	•	•	•	F	F	•	•	24	28
	22	MGE	-	B	•	•	•	•	•	•	•	F	F	•	•	24	28
	30	CUE	-	B	•	•	•	•	•	•	•	F	F	•	•	24	28
80-250	22	MGE	-	C	•	•	•	•	•	•	•	F	F	•	•	32	38
	30	CUE	-	C	•	•	•	•	•	•	•	F	F	•	•	32	38
	37	CUE	-	C	•	•	•	•	•	•	•	F	F	•	•	32	38
	45	CUE	-	C	•	•	•	•	•	•	•	F	F	•	•	32	38
80-315	55	CUE	-	C	•	•	•	•	•	•	•	F	F	•	•	32	38
	45	CUE	-	C	•	•	•	•	•	•	•	F	F	•	•	32	38
	55	CUE	-	C	•	•	•	•	•	•	•	F	F	•	•	32	38
	75	CUE	-	C	•	•	•	•	•	•	•	F	F	•	•	32	38
100-160	90	CUE	-	C	•	•	•	•	•	•	•	F	F	•	•	32	38
	110	CUE	-	C	•	•	•	•	•	•	•	F	F	•	•	32	38
	132	CUE	-	C	•	•	•	•	•	•	•	F	F	•	•	32	38
	160	CUE	•	C	•	•	•	•	•	•	•	F	F	•	•	42	48
100-200	18.5	MGE	-	C	•	•	•	•	•	•	•	F	F	•	•	24	28
	22	MGE	-	C	•	•	•	•	•	•	•	F	F	•	•	24	28
	30	CUE	-	C	•	•	•	•	•	•	•	F	F	•	•	24	28
	30	CUE	-	C	•	•	•	•	•	•	•	F	F	•	•	32	38
100-250	37	CUE	-	C	•	•	•	•	•	•	•	F	F	•	•	32	38
	45	CUE	-	C	•	•	•	•	•	•	•	F	F	•	•	32	38
	55	CUE	-	C	•	•	•	•	•	•	•	F	F	•	•	32	38
	75	CUE	-	C	•	•	•	•	•	•	•	F	F	•	•	32	38
100-315	55	CUE	-	C	•	•	•	•	•	•	•	F	F	•	•	32	38
	75	CUE	-	C	•	•	•	•	•	•	•	F	F	•	•	32	38
	90	CUE	-	C	•	•	•	•	•	•	•	F	F	•	•	32	38
	110	CUE	-	C	•	•	•	•	•	•	•	F	F	•	•	32	38
100-315	132	CUE	-	C	•	•	•	•	•	•	•	F	F	•	•	32	38
	160	CUE	•	C	•	•	•	•	•	•	•	F	F	•	•	42	48
	200	CUE	•	C	•	•	•	•	•	•	•	F	F	•	•	42	48

50 Hz, 2-pole				NB pumps				NK pumps				Cast iron pump		Stainless steel pump		Shaft seal diameter [mm]	
Pump type	P2 [kW]	E-solution	Oversize shaft	Material code		Options		Material code		Options		Flange rating ²	Flange standard	Flange rating ²	Flange standard		
				A, B, C, D, S, T E, F, G, H	K, M N, P I, J, L, R, U, W	Double seal arrangement Cartridge seal, single or double Pump housing with feet Pump with base frame	A, B, C, D, S, T E, F, G, H	K, M N, P I, J, L, R, U, W	Stuffing box Double seal arrangement Cartridge seal, single or double Standard bearing bracket Heavy-duty bearing bracket	PN 10 PN 16 DIN, code F ANSI, code G JIS, code J	PN 10 PN 16 DIN, code F ANSI, code G JIS, code J	d5 [mm]					
125-200	45	CUE	-	C	•	•	•	•	•	•	•	•	•	•	•	•	32 38
	55	CUE	-	C	•	•	•	•	•	•	•	•	•	•	•	•	32 38
	75	CUE	-	C	•	•	•	•	•	•	•	•	•	•	•	•	32 38
	90	CUE	-	C	•	•	•	•	•	•	•	•	•	•	•	•	32 38
	110	CUE	-	C	•	•	•	•	•	•	•	•	•	•	•	•	32 38
125-250	90	CUE	•	C	•	•	•	•	•	•	•	•	•	•	•	•	42 48
	110	CUE	•	C	•	•	•	•	•	•	•	•	•	•	•	•	42 48
	132	CUE	•	C	•	•	•	•	•	•	•	•	•	•	•	•	42 48
	160	CUE	•	C	•	•	•	•	•	•	•	•	•	•	•	•	42 48
	200	CUE	•	C	•	•	•	•	•	•	•	•	•	•	•	•	42 48
125-315	132	CUE	-	C	•	•	•	•	•	•	•	•	•	•	•	•	42 48
	160	CUE	-	C	•	•	•	•	•	•	•	•	•	•	•	•	42 48
	200	CUE	-	C	•	•	•	•	•	•	•	•	•	•	•	•	42 48
	250	CUE	-	-	•	•	•	•	•	•	•	•	•	•	•	•	42 48
150-200	75	CUE	-	C	•	•	•	•	•	•	•	•	•	•	•	•	32 38
	90	CUE	-	C	•	•	•	•	•	•	•	•	•	•	•	•	32 38
	110	CUE	-	C	•	•	•	•	•	•	•	•	•	•	•	•	32 38
150-250	132	CUE	-	C	•	•	•	•	•	•	•	•	•	•	•	•	42 48
	160	CUE	-	C	•	•	•	•	•	•	•	•	•	•	•	•	42 48
	200	CUE	-	C	•	•	•	•	•	•	•	•	•	•	•	•	42 48
	250	CUE	-	-	•	•	•	•	•	•	•	•	•	•	•	•	42 48
150-315.2	160	CUE	-	C	•	•	•	•	•	•	•	•	•	•	•	•	42 48
	200	CUE	-	C	•	•	•	•	•	•	•	•	•	•	•	•	42 48

¹ For information about mounting designs, see [Mechanical construction](#) on page 38.

² F: fixed flange; L: loose flange.

NB, NK, 4-pole

50 Hz, 4-pole				NB pumps				NK pumps				Cast iron pump		Stainless steel pump		Shaft seal diameter [mm]	
Pump type	P2 [kW]	E-solution	Oversize shaft	Material code		Options		Material code		Options		Flange rating ²	Flange standard	Flange rating ²	Flange standard		
				A, B, C, D, S, T E, F, G, H	K, M N, P I, J, L, R, U, W	Double seal arrangement Cartridge seal, single or double Pump housing with feet Pump with base frame	A, B, C, D, S, T E, F, G, H	K, M N, P I, J, L, R, U, W	Stuffing box Double seal arrangement Cartridge seal, single or double Standard bearing bracket Heavy-duty bearing bracket	PN 10 PN 16 DIN, code F ANSI, code G JIS, code J	PN 10 PN 16 DIN, code F ANSI, code G JIS, code J						
32-125.1	0.25	-	-	A	•	•	•	•	•	•	•	F	F	•	•	24	28
	0.37	-	-	A	•	•	•	•	•	•	•	F	F	•	•	24	28
32-125	0.25	-	-	A	•	•	•	•	•	•	•	F	F	•	•	24	28
	0.37	-	-	A	•	•	•	•	•	•	•	F	F	•	•	24	28
32-160.1	0.25	-	-	A	•	•	•	•	•	•	•	F	F	•	•	24	28
	0.37	-	-	A	•	•	•	•	•	•	•	F	F	•	•	24	28
	0.55	MGE	-	A	•	•	•	•	•	•	•	F	F	•	•	24	28
32-160	0.25	-	-	A	•	•	•	•	•	•	•	F	F	•	•	24	28
	0.37	-	-	A	•	•	•	•	•	•	•	F	F	•	•	24	28
	0.55	MGE	-	A	•	•	•	•	•	•	•	F	F	•	•	24	28
	0.75	MGE	-	A	•	•	•	•	•	•	•	F	F	•	•	24	28
32-200.1	0.37	-	-	A	•	•	•	•	•	•	•	F	F	•	•	24	28
	0.55	MGE	-	A	•	•	•	•	•	•	•	F	F	•	•	24	28
32-200	0.75	MGE	-	A	•	•	•	•	•	•	•	F	F	•	•	24	28
	0.55	MGE	-	A	•	•	•	•	•	•	•	F	F	•	•	24	28
	0.75	MGE	-	A	•	•	•	•	•	•	•	F	F	•	•	24	28
	1.1	MGE	-	A	•	•	•	•	•	•	•	F	F	•	•	24	28
32-250	1.5	MGE	-	A	•	•	•	•	•	•	•	F	F	•	•	24	28
	0.75	MGE	-	A	•	•	•	•	•	•	•	F	F	•	•	24	28
	1.1	MGE	-	A	•	•	•	•	•	•	•	F	F	•	•	24	28
	1.5	MGE	-	A	•	•	•	•	•	•	•	F	F	•	•	24	28
40-125	2.2	MGE	-	A	•	•	•	•	•	•	•	F	F	•	•	24	28
	0.25	-	-	A	•	•	•	•	•	•	•	F	F	•	•	24	28
	0.37	-	-	A	•	•	•	•	•	•	•	F	F	•	•	24	28
	0.55	MGE	-	A	•	•	•	•	•	•	•	F	F	•	•	24	28
40-160	0.37	-	-	A	•	•	•	•	•	•	•	F	F	•	•	24	28
	0.55	MGE	-	A	•	•	•	•	•	•	•	F	F	•	•	24	28
	0.75	MGE	-	A	•	•	•	•	•	•	•	F	F	•	•	24	28
	1.1	MGE	-	A	•	•	•	•	•	•	•	F	F	•	•	24	28
40-200	0.75	MGE	-	A	•	•	•	•	•	•	•	F	F	•	•	24	28
	1.1	MGE	-	A	•	•	•	•	•	•	•	F	F	•	•	24	28
	1.5	MGE	-	A	•	•	•	•	•	•	•	F	F	•	•	24	28
	2.2	MGE	-	A	•	•	•	•	•	•	•	F	F	•	•	24	28
40-250	1.5	MGE	-	A	•	•	•	•	•	•	•	F	F	•	•	24	28
	2.2	MGE	-	A	•	•	•	•	•	•	•	F	F	•	•	24	28
	3	MGE	-	A	•	•	•	•	•	•	•	F	F	•	•	24	28
	3	MGE	-	A	•	•	•	•	•	•	•	F	F	•	•	32	38
40-315	4	MGE	-	A	•	•	•	•	•	•	•	F	F	•	•	32	38
	5.5	MGE	-	A	•	•	•	•	•	•	•	F	F	•	•	32	38
	7.5	MGE	-	A	•	•	•	•	•	•	•	F	F	•	•	32	38
50-125	0.37	-	-	A	•	•	•	•	•	•	•	F	F	•	•	24	28
	0.55	MGE	-	A	•	•	•	•	•	•	•	F	F	•	•	24	28
	0.75	MGE	-	A	•	•	•	•	•	•	•	F	F	•	•	24	28
	1.1	MGE	-	A	•	•	•	•	•	•	•	F	F	•	•	24	28
50-160	0.55	MGE	-	A	•	•	•	•	•	•	•	F	F	•	•	24	28
	0.75	MGE	-	A	•	•	•	•	•	•	•	F	F	•	•	24	28
	1.1	MGE	-	A	•	•	•	•	•	•	•	F	F	•	•	24	28
	1.5	MGE	-	A	•	•	•	•	•	•	•	F	F	•	•	24	28
	2.2	MGE	-	A	•	•	•	•	•	•	F	F	•	•	24	28	

50 Hz, 4-pole				NB pumps			NK pumps				Cast iron pump		Stainless steel pump		Shaft seal diameter [mm]			
Pump type	P2 [kW]	E-solution	Oversize shaft Mounting design ¹	Material code			Options				Flange rating ²	Flange standard	Flange rating ²	Flange standard				
				A, B, C, D, S, T E, F, G, H	K, M	N, P	I, J, L, R, U, W	Double seal arrangement Cartridge seal, single or double Pump housing with feet Pump with base frame	A, B, C, D, S, T E, F, G, H	K, M	N, P	I, J, L, R, U, W	Stuffing box Double seal arrangement Cartridge seal, single or double Standard bearing bracket Heavy-duty bearing bracket	PN 10 PN 16		DIN, code F ANSI, code G JIS, code J	PN 10 PN 16	DIN, code F ANSI, code G JIS, code J
50-200	1.1	MGE	- A	•	•	•	•	•	•	•	•	•	•	•	•	24	28	
	1.5	MGE	- A	•	•	•	•	•	•	•	•	•	•	•	•	24	28	
	2.2	MGE	- A	•	•	•	•	•	•	•	•	•	•	•	•	24	28	
	3	MGE	- A	•	•	•	•	•	•	•	•	•	•	•	•	24	28	
50-250	2.2	MGE	- A	•	•	•	•	•	•	•	•	•	•	•	•	24	28	
	3	MGE	- A	•	•	•	•	•	•	•	•	•	•	•	•	24	28	
	4	MGE	- A	•	•	•	•	•	•	•	•	•	•	•	•	24	28	
50-315	4	MGE	- A	•	•	•	•	•	•	•	•	•	•	•	•	32	38	
	5.5	MGE	- A	•	•	•	•	•	•	•	•	•	•	•	•	32	38	
	7.5	MGE	- A	•	•	•	•	•	•	•	•	•	•	•	•	32	38	
	11	MGE	- C	•	•	•	•	•	•	•	•	•	•	•	•	32	38	
65-125	0.55	MGE	- A	•	•	•	•	•	•	•	•	•	•	•	•	24	28	
	0.75	MGE	- A	•	•	•	•	•	•	•	•	•	•	•	•	24	28	
	1.1	MGE	- A	•	•	•	•	•	•	•	•	•	•	•	•	24	28	
65-160	0.75	MGE	- A	•	•	•	•	•	•	•	•	•	•	•	•	24	28	
	1.1	MGE	- A	•	•	•	•	•	•	•	•	•	•	•	•	24	28	
	1.5	MGE	- A	•	•	•	•	•	•	•	•	•	•	•	•	24	28	
	2.2	MGE	- A	•	•	•	•	•	•	•	•	•	•	•	•	24	28	
65-200	1.5	MGE	- A	•	•	•	•	•	•	•	•	•	•	•	•	24	28	
	2.2	MGE	- A	•	•	•	•	•	•	•	•	•	•	•	•	24	28	
	3	MGE	- A	•	•	•	•	•	•	•	•	•	•	•	•	24	28	
	4	MGE	- A	•	•	•	•	•	•	•	•	•	•	•	•	24	28	
65-250	3	MGE	- A	•	•	•	•	•	•	•	•	•	•	•	•	32	38	
	4	MGE	- A	•	•	•	•	•	•	•	•	•	•	•	•	32	38	
	5.5	MGE	- A	•	•	•	•	•	•	•	•	•	•	•	•	32	38	
	7.5	MGE	- A	•	•	•	•	•	•	•	•	•	•	•	•	32	38	
65-315	5.5	MGE	- A	•	•	•	•	•	•	•	•	•	•	•	•	32	38	
	7.5	MGE	- A	•	•	•	•	•	•	•	•	•	•	•	•	32	38	
	11	MGE	- C	•	•	•	•	•	•	•	•	•	•	•	•	32	38	
	15	MGE	- C	•	•	•	•	•	•	•	•	•	•	•	•	32	38	
80-160	1.5	MGE	- A	•	•	•	•	•	•	•	•	•	•	•	•	24	28	
	2.2	MGE	- A	•	•	•	•	•	•	•	•	•	•	•	•	24	28	
	3	MGE	- A	•	•	•	•	•	•	•	•	•	•	•	•	24	28	
	4	MGE	- A	•	•	•	•	•	•	•	•	•	•	•	•	24	28	
80-200	2.2	MGE	- A	•	•	•	•	•	•	•	•	•	•	•	•	32	38	
	3	MGE	- A	•	•	•	•	•	•	•	•	•	•	•	•	32	38	
	4	MGE	- A	•	•	•	•	•	•	•	•	•	•	•	•	32	38	
	5.5	MGE	- A	•	•	•	•	•	•	•	•	•	•	•	•	32	38	
80-250	7.5	MGE	- A	•	•	•	•	•	•	•	•	•	•	•	•	32	38	
	5.5	MGE	- A	•	•	•	•	•	•	•	•	•	•	•	•	32	38	
	7.5	MGE	- A	•	•	•	•	•	•	•	•	•	•	•	•	32	38	
	11	MGE	- C	•	•	•	•	•	•	•	•	•	•	•	•	32	38	
80-315	11	MGE	- C	•	•	•	•	•	•	•	•	•	•	•	•	32	38	
	15	MGE	- C	•	•	•	•	•	•	•	•	•	•	•	•	32	38	
	18.5	MGE	- C	•	•	•	•	•	•	•	•	•	•	•	•	32	38	
	22	CUE	- C	•	•	•	•	•	•	•	•	•	•	•	•	32	38	
80-400	18.5	MGE	- C	•	•	•	•	•	•	•	•	•	•	•	•	42	48	
	22	CUE	- C	•	•	•	•	•	•	•	•	•	•	•	•	42	48	
	30	CUE	- C	•	•	•	•	•	•	•	•	•	•	•	•	42	48	
	37	CUE	- C	•	•	•	•	•	•	•	•	•	•	•	•	42	48	
	45	CUE	- C	•	•	•	•	•	•	•	•	•	•	•	•	42	48	

50 Hz, 4-pole				NB pumps				NK pumps				Cast iron pump		Stainless steel pump		Shaft seal diameter [mm]
Pump type	P2 [kW]	E-solution	Oversize shaft Mounting design ¹	Material code		Options		Material code		Options		Flange rating ²	Flange standard	Flange rating ²	Flange standard	
				A, B, C, D, S, T E, F, G, H	K, M N, P I, J, L, R, U, W	Double seal arrangement Cartridge seal, single or double Pump housing with feet Pump with base frame	A, B, C, D, S, T E, F, G, H	K, M N, P I, J, L, R, U, W	Stuffing box Double seal arrangement Cartridge seal, single or double Standard bearing bracket Heavy-duty bearing bracket	PN 10 PN 16	DIN, code F ANSI, code G JIS, code J	PN 10 PN 16	DIN, code F ANSI, code G JIS, code J			
100-160	2.2	MGE	A	•	•	•	•	•	•	•	•	F	F	L	L	24 28
	3	MGE	A	•	•	•	•	•	•	•	•	F	F	L	L	24 28
	4	MGE	A	•	•	•	•	•	•	•	•	F	F	L	L	24 28
100-200	4	MGE	A	•	•	•	•	•	•	•	•	F	F	L	L	32 38
	5.5	MGE	A	•	•	•	•	•	•	•	•	F	F	L	L	32 38
	7.5	MGE	A	•	•	•	•	•	•	•	•	F	F	L	L	32 38
	11	MGE	C	•	•	•	•	•	•	•	•	F	F	L	L	32 38
100-250	7.5	MGE	A	•	•	•	•	•	•	•	•	F	F	L	L	32 38
	11	MGE	C	•	•	•	•	•	•	•	•	F	F	L	L	32 38
	15	MGE	C	•	•	•	•	•	•	•	•	F	F	L	L	32 38
100-315	15	MGE	C	•	•	•	•	•	•	•	•	F	F	L	L	32 38
	18.5	MGE	C	•	•	•	•	•	•	•	•	F	F	L	L	32 38
	22	CUE	C	•	•	•	•	•	•	•	•	F	F	L	L	32 38
	30	CUE	C	•	•	•	•	•	•	•	•	F	F	L	L	32 38
100-400	22	CUE	C	•	•	•	•	•	•	•	•	F	F	L	L	42 48
	30	CUE	C	•	•	•	•	•	•	•	•	F	F	L	L	42 48
	37	CUE	C	•	•	•	•	•	•	•	•	F	F	L	L	42 48
	45	CUE	C	•	•	•	•	•	•	•	•	F	F	L	L	42 48
	55	CUE	C	•	•	•	•	•	•	•	•	F	F	L	L	42 48
125-200	5.5	MGE	C	•	•	•	•	•	•	•	•	F	F	L	L	32 38
	7.5	MGE	C	•	•	•	•	•	•	•	•	F	F	L	L	32 38
	11	MGE	C	•	•	•	•	•	•	•	•	F	F	L	L	32 38
	15	MGE	C	•	•	•	•	•	•	•	•	F	F	L	L	32 38
125-250	11	MGE	C	•	•	•	•	•	•	•	•	F	F	L	L	32 38
	15	MGE	C	•	•	•	•	•	•	•	•	F	F	L	L	32 38
	18.5	MGE	C	•	•	•	•	•	•	•	•	F	F	L	L	32 38
	22	CUE	C	•	•	•	•	•	•	•	•	F	F	L	L	32 38
	30	CUE	C	•	•	•	•	•	•	•	•	F	F	L	L	32 38
125-315	18.5	MGE	C	•	•	•	•	•	•	•	•	F	F	L	L	42 48
	22	CUE	C	•	•	•	•	•	•	•	•	F	F	L	L	42 48
	30	CUE	C	•	•	•	•	•	•	•	•	F	F	L	L	42 48
	37	CUE	C	•	•	•	•	•	•	•	•	F	F	L	L	42 48
	45	CUE	C	•	•	•	•	•	•	•	•	F	F	L	L	42 48
125-400	37	CUE	C	•	•	•	•	•	•	•	•	F	F	L	L	42 48
	45	CUE	C	•	•	•	•	•	•	•	•	F	F	L	L	42 48
	55	CUE	C	•	•	•	•	•	•	•	•	F	F	L	L	42 48
	75	CUE	C	•	•	•	•	•	•	•	•	F	F	L	L	42 48
	90	CUE	C	•	•	•	•	•	•	•	•	F	F	L	L	42 48
125-500	55	CUE	C	•	•	•	•	•	•	•	•	F	F	L	L	60 60
	75	CUE	C	•	•	•	•	•	•	•	•	F	F	L	L	60 60
	90	CUE	C	•	•	•	•	•	•	•	•	F	F	L	L	60 60
	110	CUE	C	•	•	•	•	•	•	•	•	F	F	L	L	60 60
	132	CUE	C	•	•	•	•	•	•	•	•	F	F	L	L	60 60
	160	CUE	C	•	•	•	•	•	•	•	•	F	F	L	L	60 60
150-200	7.5	MGE	A	•	•	•	•	•	•	•	•	F	-	L	L	32 38
	11	MGE	C	•	•	•	•	•	•	•	•	F	-	L	L	32 38
	15	MGE	C	•	•	•	•	•	•	•	•	F	-	L	L	32 38
150-250	18.5	MGE	C	•	•	•	•	•	•	•	•	F	-	L	L	42 48
	22	CUE	C	•	•	•	•	•	•	•	•	F	-	L	L	42 48
	30	CUE	C	•	•	•	•	•	•	•	•	F	-	L	L	42 48
	37	CUE	C	•	•	•	•	•	•	•	•	F	-	L	L	42 48
	45	CUE	C	•	•	•	•	•	•	•	•	F	-	L	L	42 48
	55	MGE	C	•	•	•	•	•	•	•	•	F	-	L	L	42 48

50 Hz, 4-pole				NB pumps			NK pumps				Cast iron pump		Stainless steel pump		Shaft seal diameter [mm]	
Pump type	P2 [kW]	E-solution	Oversize shaft Mounting design ¹	Material code		Options		Material code		Options		Flange rating ²	Flange standard	Flange rating ²		Flange standard
				A, B, C, D, S, T E, F, G, H	K, M N, P I, J, L, R, U, W	Double seal arrangement Cartridge seal, single or double Pump housing with feet Pump with base frame	A, B, C, D, S, T E, F, G, H	K, M N, P I, J, L, R, U, W	Stuffing box Double seal arrangement Cartridge seal, single or double Standard bearing bracket Heavy-duty bearing bracket	PN 10 PN 16 DIN, code F ANSI, code G JIS, code J	PN 10 PN 16 DIN, code F ANSI, code G JIS, code J					
150-315.2	22	CUE	- C	•	•	•	•	•	•	•	•	F	-	L	L	42 48
	30	CUE	- C	•	•	•	•	•	•	•	•	F	-	L	L	42 48
	37	CUE	- C	•	•	•	•	•	•	•	•	F	-	L	L	42 48
	45	CUE	- C	•	•	•	•	•	•	•	•	F	-	L	L	42 48
	55	CUE	- C	•	•	•	•	•	•	•	•	F	-	L	L	42 48
150-315	75	CUE	- C	•	•	•	•	•	•	•	•	F	-	L	L	42 48
	37	CUE	- C	•	•	•	•	•	•	•	•	F	-	L	L	42 48
	45	CUE	- C	•	•	•	•	•	•	•	•	F	-	L	L	42 48
	55	CUE	- C	•	•	•	•	•	•	•	•	F	-	L	L	42 48
	75	CUE	- C	•	•	•	•	•	•	•	•	F	-	L	L	42 48
150-400	90	CUE	- C	•	•	•	•	•	•	•	•	F	-	L	L	42 48
	55	CUE	- C	•	•	•	•	•	•	•	•	F	-	L	L	42 ³ 48 ⁴
	75	CUE	- C	•	•	•	•	•	•	•	•	F	-	L	L	42 ³ 48 ⁴
	90	CUE	- C	•	•	•	•	•	•	•	•	F	-	L	L	42 ³ 48 ⁴
	110	CUE	- C	•	•	•	•	•	•	•	•	F	-	L	L	42 ³ 48 ⁴
150-500	132	CUE	• C	•	•	•	•	•	•	•	•	F	-	L	L	48 55
	160	CUE	• C	•	•	•	•	•	•	•	•	F	-	L	L	48 55
	132	CUE	- C	•	•	•	•	•	•	•	•	F	-	L	L	60 60
	160	CUE	- C	•	•	•	•	•	•	•	•	F	-	L	L	60 60
	200	CUE	- C	•	•	•	•	•	•	•	•	F	-	L	L	60 60
200-400	37	CUE	- C	•	•	•	•	•	•	•	•	F	F	-	-	48 55
	45	CUE	- C	•	•	•	•	•	•	•	•	F	F	-	-	48 55
	55	CUE	- C	•	•	•	•	•	•	•	•	F	F	-	-	48 55
	75	CUE	- C	•	•	•	•	•	•	•	•	F	F	-	-	48 55
	90	CUE	- C	•	•	•	•	•	•	•	•	F	F	-	-	48 55
200-450	110	CUE	- C	•	•	•	•	•	•	•	•	F	F	-	-	48 55
	132	CUE	- C	•	•	•	•	•	•	•	•	F	F	-	-	48 55
	160	CUE	- C	•	•	•	•	•	•	•	•	F	F	-	-	48 55
	37	CUE	- C	•	•	•	•	•	•	•	•	F	F	-	-	48 55
	45	CUE	- C	•	•	•	•	•	•	•	•	F	F	-	-	48 55
250-350	55	CUE	- C	•	•	•	•	•	•	•	•	F	F	-	-	48 55
	75	CUE	- C	•	•	•	•	•	•	•	•	F	F	-	-	48 55
	90	CUE	- C	•	•	•	•	•	•	•	•	F	F	-	-	48 55
	45	CUE	- C	•	•	•	•	•	•	•	•	F	F	-	-	48 55
	55	CUE	- C	•	•	•	•	•	•	•	•	F	F	-	-	48 55
250-400	75	CUE	- C	•	•	•	•	•	•	•	•	F	F	-	-	48 55
	90	CUE	- C	•	•	•	•	•	•	•	•	F	F	-	-	48 55
	110	CUE	- C	•	•	•	•	•	•	•	•	F	F	-	-	48 55
	132	CUE	- C	•	•	•	•	•	•	•	•	F	F	-	-	48 55
	160	CUE	- C	•	•	•	•	•	•	•	•	F	F	-	-	48 55
250-450	75	CUE	- C	•	•	•	•	•	•	•	•	F	F	-	-	60 60
	90	CUE	- C	•	•	•	•	•	•	•	•	F	F	-	-	60 60
	110	CUE	- C	•	•	•	•	•	•	•	•	F	F	-	-	60 60
	132	CUE	- C	•	•	•	•	•	•	•	•	F	F	-	-	60 60
	160	CUE	- C	•	•	•	•	•	•	•	•	F	F	-	-	60 60
200	CUE	- C	•	•	•	•	•	•	•	•	F	F	-	-	60 60	

50 Hz, 4-pole				NB pumps				NK pumps				Cast iron pump		Stainless steel pump		Shaft seal diameter [mm]									
Pump type	P2 [kW]	E-solution	Oversize shaft	Material code				Options				Flange rating ²	Flange standard	Flange rating ²			Flange standard								
				Mounting design ¹	A, B, C, D, S, T	E, F, G, H	K, M	N, P	I, J, L, R, U, W	Double seal arrangement Cartridge seal, single or double Pump housing with feet Pump with base frame	A, B, C, D, S, T			E, F, G, H	K, M		N, P	I, J, L, R, U, W	Stuffing box Double seal arrangement Cartridge seal, single or double Standard bearing bracket Heavy-duty bearing bracket	PN 10	PN 16	DIN, code F ANSI, code G JIS, code J	PN 10	PN 16	DIN, code F ANSI, code G JIS, code J
250-500	160	CUE	-	C	•	•	-	-	-	-	•	•	-	-	-	-	-	-	-	-	60	60			
	200	CUE	-	C	•	•	-	-	-	-	•	•	-	-	-	-	-	-	-	-	60	60			
	250	CUE	-	-	-	-	-	-	-	-	•	•	-	-	-	-	-	-	-	-	60	60			
	315	-	-	-	-	-	-	-	-	-	•	•	-	-	-	-	-	-	-	-	60	60			

¹ For information about mounting designs, see [Mechanical construction](#) on page 38.
² F: fixed flange; L: loose flange.
³ For NB, d5 is equal to 48 mm.
⁴ For NB, the shaft seal diameter is equal to 55 mm.

50 Hz, 6-pole				NB pumps			NK pumps				Cast iron pump		Stainless steel pump			Shaft seal diameter [mm]			
Pump type	P2 [kW]	E-solution	Oversize shaft	Material code		Options	Material code		Options		Flange rating ²	Flange standard	Flange rating ²	Flange standard	d5 [mm]				
				A, B, C, D, S, T	E, F, G, H	K, M	N, P	I, J, L, R, U, W	A, B, C, D, S, T	E, F, G, H	K, M	N, P	I, J, L, R, U, W	PN 10			PN 16	DIN, code F	ANSI, code G
				Mounting design ¹		Double seal arrangement Cartridge seal, single or double Pump housing with feet Pump with base frame			Mounting design ¹		Double seal arrangement Cartridge seal, single or double Standard bearing bracket Heavy-duty bearing bracket					Mounting design ¹			
150-315	11	CUE	-	C	•	-	•	•	•	•	•	•	-	-	-	-	42	48	
	15	CUE	-	C	•	-	•	•	•	•	•	•	-	-	-	-	42	48	
	18.5	CUE	-	C	•	-	•	•	•	•	•	•	-	-	-	-	42	48	
	22	CUE	-	C	•	-	•	•	•	•	•	•	-	-	-	-	42	48	
	30	CUE	-	C	•	-	•	•	•	•	•	•	-	-	-	-	42	48	
150-400	18.5	CUE	-	C	•	-	•	•	•	•	•	•	-	-	-	-	42 ³	48 ⁴	
	22	CUE	-	C	•	-	•	•	•	•	•	•	-	-	-	-	42 ³	48 ⁴	
	30	CUE	-	C	•	-	•	•	•	•	•	•	-	-	-	-	42 ³	48 ⁴	
	37	CUE	-	C	•	-	•	•	•	•	•	•	-	-	-	-	42 ³	48 ⁴	
	45	CUE	-	C	•	-	•	•	•	•	•	•	-	-	-	-	42 ³	48 ⁴	
150-500	37	CUE	-	C	•	-	•	•	•	•	•	•	-	-	-	-	60	60	
	45	CUE	-	C	•	-	•	•	•	•	•	•	-	-	-	-	60	60	
	55	CUE	-	C	•	-	•	•	•	•	•	•	-	-	-	-	60	60	
	75	CUE	-	C	•	-	•	•	•	•	•	•	-	-	-	-	60	60	
200-400	15	CUE	-	C	•	•	-	-	-	•	•	-	-	-	-	-	48	55	
	18.5	CUE	-	C	•	•	-	-	-	•	•	-	-	-	-	-	48	55	
	22	CUE	-	C	•	•	-	-	-	•	•	-	-	-	-	-	48	55	
	30	CUE	-	C	•	•	-	-	-	•	•	-	-	-	-	-	48	55	
	37	CUE	-	C	•	•	-	-	-	•	•	-	-	-	-	-	48	55	
200-450	18.5	CUE	-	C	•	•	-	-	-	•	•	-	-	-	-	-	48	55	
	22	CUE	-	C	•	•	-	-	-	•	•	-	-	-	-	-	48	55	
	30	CUE	-	C	•	•	-	-	-	•	•	-	-	-	-	-	48	55	
	37	CUE	-	C	•	•	-	-	-	•	•	-	-	-	-	-	48	55	
	45	CUE	-	C	•	•	-	-	-	•	•	-	-	-	-	-	48	55	
250-350	11	CUE	-	C	•	•	-	-	-	•	•	-	-	-	-	-	48	55	
	15	CUE	-	C	•	•	-	-	-	•	•	-	-	-	-	-	48	55	
	18.5	CUE	-	C	•	•	-	-	-	•	•	-	-	-	-	-	48	55	
	22	CUE	-	C	•	•	-	-	-	•	•	-	-	-	-	-	48	55	
	15	CUE	-	C	•	•	-	-	-	•	•	-	-	-	-	-	48	55	
250-400	18.5	CUE	-	C	•	•	-	-	-	•	•	-	-	-	-	-	48	55	
	22	CUE	-	C	•	•	-	-	-	•	•	-	-	-	-	-	48	55	
	30	CUE	-	C	•	•	-	-	-	•	•	-	-	-	-	-	48	55	
	37	CUE	-	C	•	•	-	-	-	•	•	-	-	-	-	-	48	55	
	45	CUE	-	C	•	•	-	-	-	•	•	-	-	-	-	-	48	55	
250-450	18.5	CUE	-	C	•	•	-	-	-	•	•	-	-	-	-	-	60	60	
	22	CUE	-	C	•	•	-	-	-	•	•	-	-	-	-	-	60	60	
	30	CUE	-	C	•	•	-	-	-	•	•	-	-	-	-	-	60	60	
	37	CUE	-	C	•	•	-	-	-	•	•	-	-	-	-	-	60	60	
	45	CUE	-	C	•	•	-	-	-	•	•	-	-	-	-	-	60	60	
250-500	55	CUE	-	C	•	•	-	-	-	•	•	-	-	-	-	-	60	60	
	45	CUE	-	C	•	•	-	-	-	•	•	-	-	-	-	-	60	60	
	55	CUE	-	C	•	•	-	-	-	•	•	-	-	-	-	-	60	60	
	75	CUE	-	C	•	•	-	-	-	•	•	-	-	-	-	-	60	60	
	90	CUE	-	C	•	•	-	-	-	•	•	-	-	-	-	-	60	60	

¹ For information about mounting designs, see [Mechanical construction](#) on page 38.
² F: fixed flange; L: loose flange.
³ For NB, d5 is equal to 48 mm.
⁴ For NB, the shaft seal diameter is equal to 55 mm.

E-pumps

P2, MGE motor [kW]	NBE, NKE ¹		NBE, NKE Series 2000 ²	
	2-pole	4-pole	2-pole	4-pole
0.55	-	•	-	•
0.75	-	•	-	•
1.1	•	•	•	•
2.2	•	•	•	•
3	•	•	•	•
4	•	•	•	•
5.5	•	•	•	•
7.5	•	•	•	•
11	•	•	•	-
15	•	•	-	-
18.5	•	•	-	-
22	•	-	-	-

¹ For the dimensions of NBE, NKE pumps, see sections [Technical data, NB](#) on page 133 and [Technical data, NK](#) on page 142.

² For the dimensions of NBE, NKE Series 2000 pumps with factory-fitted differential-pressure sensor, see section [Technical data, NBE, NKE Series 2000](#) on page 150.

5. Identification

Nameplate

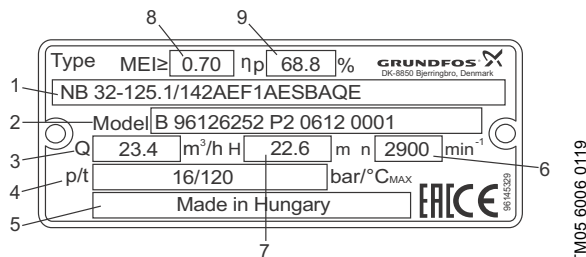

Fig. 5 Example of nameplate

Pos.	Description
1	Type designation
2	Model
	B Model
	96126252 Product number
	P2 Production site code
	0612 Production date, year and week
	0001 Serial number
3	Rated flow
4	Pressure rating or maximum temperature
5	Country of origin
6	Rated speed
7	Pump head
8	Minimum efficiency index
9	Hydraulic pump efficiency at optimum efficiency point

Type key, NB, NBE

Example 1 - Pump design according to EN 733	NBE	32	-125	.1	/142	S2	AE	F	1	A	E	S	BAQE
Example 2 - Pump design according to ISO 2858	NBG	125	-100	-160	/160-142		A	F	2	N	K	S	DQKQ
Type range													
NB, NBG Pump with standard motor													
NBE, NBGE Pump with MGE motor													
Nominal diameter of inlet port (DN)													
Nominal diameter of outlet port (DN)													
Nominal impeller diameter [mm]													
Reduced performance equal to .1													
Actual impeller diameter [mm]													
Sensor version													
S1 Without factory-fitted sensor, pressure sensor is supplied with the pump													
S2 With factory-fitted differential-pressure sensor, Series 2000													
Code for pump version; the codes may be combined.													
A Basic version													
B Oversize motor													
C Without motor													
D Pump housing with feet													
E With ATEX approval, certificate or test report, the second character of the code for pump version is an E													
F With base frame													
S With support blocks													
X Special version, in case of further customisation than already listed													
Pipe connection													
E Table E flange													
F DIN flange													
G ANSI flange													
J JIS flange													
Flange pressure rating (PN - nominal pressure)													
1 10 bar													
2 16 bar													
3 25 bar													
4 40 bar													
5 Other pressure rating													
Materials													
Pump housing													
A EN-GJL-250	EN-GJL-200	Bronze/brass	1.4301										
B EN-GJL-250	Bronze CuSn10	Bronze/brass	1.4301										
C EN-GJL-250	EN-GJL-200	Bronze/brass	1.4401										
D EN-GJL-250	Bronze CuSn10	Bronze/brass	1.4401										
E EN-GJL-250	EN-GJL-200	EN-GJL-250	1.4301										

Example 1 - Pump design according to EN 733				NBE	32	-125	.1	/142	S2	AE	F	1	A	E	S	BAQE
Example 2 - Pump design according to ISO 2858				NBG	125	-100	-160	/160-142		A	F	2	N	K	S	DQQK
F	EN-GJL-250	Bronze CuSn10	EN-GJL-250	1.4301												
G	EN-GJL-250	EN-GJL-200	EN-GJL-250	1.4401												
H	EN-GJL-250	Bronze CuSn10	EN-GJL-250	1.4401												
I	1.4408	1.4408	1.4517	1.4462												
J	1.4408	1.4408	Carbon-graphite-filled PTFE (Graflon®)	1.4462												
K	1.4408	1.4408	1.4517	1.4401												
L	1.4517	1.4517	1.4517	1.4462												
M	1.4408	1.4517	1.4517	1.4401												
N	1.4408	1.4408	Carbon-graphite-filled PTFE (Graflon®)	1.4401												
P	1.4408	1.4517	Carbon-graphite-filled PTFE (Graflon®)	1.4401												
R	1.4517	1.4517	Carbon-graphite-filled PTFE (Graflon®)	1.4462												
S	EN-GJL-250	1.4408	Bronze/brass	1.4401												
T	EN-GJL-250	1.4517	Bronze/brass	1.4462												
U	1.4408	1.4517	1.4517	1.4462												
W	1.4408	1.4517	Carbon-graphite-filled PTFE (Graflon®)	1.4462												
X	Special version															
Rubber parts in pump																
The letter indicates material of pump cover O-ring																
E EPDM																
F FXM (Fluoraz®)																
K FFKM (Kalrez®)																
M FEPS (PTFE-sheathed silicone O-ring)																
X HNBR																
V FKM (Viton®)																
Shaft seal arrangement																
S Single seal																
Code for mechanical shaft seal and shaft seal rubber parts																

Example 1 - Pump design according to EN 733				NBE	32	-125	.1	/142	S2	AE	F	1	A	E	S	BAQE
Example 2 - Pump design according to ISO 2858				NBG	125	-100	-160	/160-142		A	F	2	N	K	S	DQQK

Example 1 shows an NBE 32-125.1 pump with these features:

- pump with MGE motor
- reduced performance
- 142 mm impeller
- with factory-fitted differential-pressure sensor, Series 2000
- basic version
- report or certificate
- DIN flange to EN 1092-2 pipe connection
- 10 bar flange pressure rating
- cast iron pump housing, EN-GJL-250
- cast iron impeller, EN-GJL-200
- bronze/brass wear ring
- stainless steel shaft, EN 1.4301
- EPDM pump cover O-ring
- single shaft seal arrangement
- BAQE shaft seal.

Example 2 shows an NBG 125-100-160 pump with these features:

- 160-142 mm conical impeller
- basic version
- DIN flange to EN 1092-2 pipe connection
- 16 bar flange pressure rating
- stainless steel pump housing, EN 1.4408
- stainless steel impeller, EN 1.4408
- carbon-graphite-filled wear ring, PTFE (Graflon®)
- stainless steel shaft, EN 1.4401
- FFKM pump cover O-ring
- single shaft seal arrangement
- DQQK shaft seal.

Type key, NK, NKE

Model B

Example 1 - Pump design according to EN 733	NKE	32	-125	.1	/142	S2	A1	F	1	A	E	S	BAQE
Example 2 - Pump design according to ISO 2858	NKG	125	-100	-160	/160-142	H2	F	3	N	KE	O	2926	
Type range													
NK, NKG Pump with standard motor													
NKE, NKGE Pump with MGE motor													
Nominal diameter of inlet port (DN)													
Nominal diameter of outlet port (DN)													
Nominal impeller diameter [mm]													
Reduced performance equal to .1													
Actual impeller diameter [mm]													
Sensor version													
S1 Without factory-fitted sensor, pressure sensor is supplied with the pump													
S2 With factory-fitted differential-pressure sensor, Series 2000													
Code for pump version; the codes may be combined.													
A1 Basic version, grease-lubricated standard bearing design, standard coupling													
A2 Basic version, grease-lubricated standard bearing design, spacer coupling													
B Oversize motor													
E With ATEX approval, certificate or test report, the second character of the code for pump version is an E													
G1 Grease-lubricated heavy-duty bearing design, standard coupling													
G2 Grease-lubricated heavy-duty bearing design, spacer coupling													
H1 Oil-lubricated heavy-duty bearing design, standard coupling													
H2 Oil-lubricated heavy-duty bearing design, spacer coupling													
I1 Pump without motor, with grease-lubricated standard bearing design, standard coupling													
I2 Pump without motor, with grease-lubricated standard bearing design, spacer coupling													
J1 Pump without motor, with grease-lubricated heavy-duty bearing design, standard coupling													
J2 Pump without motor, with grease-lubricated heavy-duty bearing design, spacer coupling													
K1 Pump without motor, with oil-lubricated heavy-duty bearing design, standard coupling													
K2 Pump without motor, with oil-lubricated heavy-duty bearing design, spacer coupling													
Y1 Bare shaft pump, with grease-lubricated standard bearing design													
W1 Bare shaft pump, with grease-lubricated heavy-duty bearing design													
Z1 Bare shaft pump, with oil-lubricated heavy-duty bearing design													
X Special version, if further customisation than already listed													
Pipe connection													
E Table E flange													
F DIN flange													
G ANSI flange													
J JIS flange													
Flange pressure rating (PN - nominal pressure)													
1 10 bar													
2 16 bar													
3 25 bar													
4 40 bar													
5 Other pressure rating													
Materials													
	Pump housing	Impeller	Wear ring	Shaft									
A	EN-GJL-250	EN-GJL-200	Bronze/brass	1.4021/1.4034									
B	EN-GJL-250	Bronze CuSn10	Bronze/brass	1.4021/1.4034									
C	EN-GJL-250	EN-GJL-200	Bronze/brass	1.4401									
D	EN-GJL-250	Bronze CuSn10	Bronze/brass	1.4401									
E	EN-GJL-250	EN-GJL-200	EN-GJL-250	1.4021/1.4034									
F	EN-GJL-250	Bronze CuSn10	EN-GJL-250	1.4021/1.4034									
G	EN-GJL-250	EN-GJL-200	EN-GJL-250	1.4401									
H	EN-GJL-250	Bronze CuSn10	EN-GJL-250	1.4401									
I	1.4408	1.4408	1.4517	1.4462									
J	1.4408	1.4408	Carbon-graphite-filled PTFE (Graflon®)	1.4462									
K	1.4408	1.4408	1.4517	1.4401									
L	1.4517	1.4517	1.4517	1.4462									
M	1.4408	1.4517	1.4517	1.4401									

Example 1 - Pump design according to EN 733	NKE	32	-125	.1	/142	S2	A1	F	1	A	E	S	BAQE
Example 2 - Pump design according to ISO 2858	NKG	125	-100	-160	/160-142	H2	F	3	N	KE	O	2926	
N	1.4408	1.4408	Carbon-graphite-filled PTFE (Graflon®)	1.4401									
P	1.4408	1.4517	Carbon-graphite-filled PTFE (Graflon®)	1.4401									
R	1.4517	1.4517	Carbon-graphite-filled PTFE (Graflon®)	1.4462									
S	EN-GJL-250	1.4408	Bronze/brass	1.4401									
T	EN-GJL-250	1.4517	Bronze/brass	1.4462									
U	1.4408	1.4517	1.4517	1.4462									
W	1.4408	1.4517	Carbon-graphite-filled PTFE (Graflon®)	1.4462									
X	Special version												
Rubber parts in pump													
First letter indicates material of pump cover O-ring and seal cover O-ring. The seal cover O-ring is only for double seal arrangements.													
Second letter indicates material of seal housing O-ring													
E EPDM													
F FXM (Fluoraz®)													
K FFKM (Kalrez®)													
M FEPS (PTFE-sheathed silicone O-ring)													
V FKM (Viton®)													
X HNBR													
Shaft seal arrangement													
B Stuffing box													
C Cartridge seal, single													
D Cartridge seal, double													
O Back-to-back, double seal													
P Tandem, double seal													
S Single seal													
Shaft seal(s) in pump													
Letter or digit code for mechanical shaft seal and shaft seal rubber parts													
4 letters: Single mechanical shaft seal, such as BQQE, or single cartridge seal, such as HBQV.													
4 digits: Double seal solution, such as 2716, where 27 is equal to DQQV (primary seal), and 16 is equal to BQQV (secondary seal) or double cartridge seal, such as 5150, where 51 is equal to HQQU (primary seal), and 50 is equal to HBQV (secondary seal).													
The relation between letters and digits of the shaft seals is described on page 30.													

Example 1 - Pump design according to EN 733	NKE	32	-125	.1	/142	S2	A1	F	1	A	E	S	BAQE
Example 2 - Pump design according to ISO 2858	NKG	125	-100	-160	/160-142	H2	F	3	N	KE	O	2926	

Example 1 shows an NKE 32-125.1 pump with these features:

- pump with MGE motor
- reduced performance
- 142 mm impeller
- with factory-fitted differential-pressure sensor, Series 2000
- grease-lubricated standard bearing design
- standard coupling
- DIN flange to EN 1092-2 pipe connection
- PN 10 flange
- cast iron pump housing, EN-GJL-250
- cast iron impeller, EN-GJL-200
- bronze/brass wear ring
- stainless steel shaft, EN 1.4021/1.4034
- EPDM pump cover O-ring
- single shaft seal arrangement
- BAQE shaft seal.

Example 2 shows an NKG 125-100-160 pump with these features:

- 160-142 mm conical impeller
- grease-lubricated heavy-duty bearing design
- spacer coupling
- DIN flange to EN 1092-2 pipe connection
- PN 25 flange
- stainless steel pump housing, EN 1.4408
- stainless steel impeller, EN 1.4408
- carbon-graphite-filled wear ring, PTFE (Graflon®)
- stainless steel shaft, EN 1.4401
- FFKM pump cover and seal cover O-rings
- EPDM seal housing O-ring
- back-to-back double shaft seal arrangement
- primary shaft seal: DQQK
- secondary shaft seal: DQQE.

Relation between letter and digit code of shaft seal and stuffing box description

Digits	Letters	Description
10	BAQE	Single mechanical shaft seal
11	BAQV	Single mechanical shaft seal
12	BBQE	Single mechanical shaft seal
13	BBQV	Single mechanical shaft seal
15	BQQE	Single mechanical shaft seal
16	BQQV	Single mechanical shaft seal
19	AQAE	Single mechanical shaft seal
20	AQAV	Single mechanical shaft seal
21	AQQE	Single mechanical shaft seal
22	AQQV	Single mechanical shaft seal
23	AQQX	Single mechanical shaft seal
24	AQQK	Single mechanical shaft seal
25	DAQF	Single mechanical shaft seal
26	DQQE	Single mechanical shaft seal
27	DQQV	Single mechanical shaft seal
28	DQQX	Single mechanical shaft seal
29	DQQK	Single mechanical shaft seal
50	HBQV	Cartridge seal
51	HQQU	Cartridge seal
52	HAQK	Cartridge seal
	SNEA	Stuffing box, internal barrier liquid, Buraflon® packing rings ¹ , EPDM O-rings in the pump housing
	SNEB	Stuffing box, internal barrier liquid, Thermoflon® packing rings ² , EPDM O-rings in the pump housing
	SNEC	Stuffing box, internal barrier liquid, Buraflon® packing rings ¹ , FKM O-rings in the pump housing
	SNED	Stuffing box, internal barrier liquid, Thermoflon® packing rings ² , FKM O-rings in the pump housing
	SNOA	Stuffing box, without barrier liquid, Buraflon® packing rings ¹ , EPDM O-rings in the pump housing
	SNOB	Stuffing box, without barrier liquid, Thermoflon® packing rings ² , EPDM O-rings in the pump housing
	SNOC	Stuffing box, without barrier liquid, Buraflon® packing rings ¹ , FKM O-rings in the pump housing
	SNOD	Stuffing box, without barrier liquid, Thermoflon® packing rings ² , FKM O-rings in the pump housing
	SNFA	Stuffing box, external barrier liquid, Buraflon® packing rings ¹ , EPDM O-rings in the pump housing
	SNFB	Stuffing box, external barrier liquid, Thermoflon® packing rings ² , EPDM O-rings in the pump housing
	SNFC	Stuffing box, external barrier liquid, Buraflon® packing rings ¹ , FKM O-rings in the pump housing
	SNFD	Stuffing box, external barrier liquid, Thermoflon® packing rings ² , FKM O-rings in the pump housing

¹ Buraflon® packing rings are PTFE impregnated fibre packing rings.
² Thermoflon® packing rings are graphite-PTFE compound packing rings.

Shaft seals

Codes for shaft seals

Positions (1) to (4) cover four pieces of information about the shaft seal:

Example	(1)	(2)	(3)	(4)
Grundfos type designation				
Material, rotating seal face				
Material, stationary seat				
Material, secondary seal and other rubber and composite parts, except the wear ring				

The following table explains positions (1), (2), (3) and (4).

Pos.	Type	Short description of seal
(1)	A	O-ring seal with fixed driver
	B	Rubber bellows seal
	D	O-ring seal, balanced
	H	Cartridge seal, balanced
Pos.	Type	Material
(2)	A	Synthetic carbons:
		Carbon, metal-impregnated (antimony, not approved for potable water)
		Carbon, resin-impregnated
(3)	B	Carbides:
		Silicon carbide
Pos.	Type	Material
(4)	E	EPDM
	V	FKM (Viton®)
	F	FXM (Fluoraz®)
	K	FFKM (Kalrez®)
	X	HNBR
	U	Dynamic O-rings in FFKM and static O-rings in PTFE

For a thorough description of shaft seal types and materials, see the data booklet "NB, NBG, NK, NKG, NBE, NBGE, NKE, NKGE - Custom-built pumps according to EN 733 and ISO 2858".

Stuffing boxes, NK

Various types of stuffing boxes are available as an alternative to shaft seals. Stuffing boxes are not quite as sensitive as shaft seals and therefore suitable for many different applications.

Three types of stuffing boxes are available for NK pumps: SNE(x), SNO(x) and SNF(x).

Codes for stuffing boxes

Positions (1) to (4) cover information about the stuffing box:

Pos.	Code	Short description of stuffing box
(1)	S	Packing type stuffing box
Pos.	Code	Cooling method
(2)	N	Uncooled stuffing box
Pos.	Code	Barrier liquid
(3)	E	With internal barrier liquid
	F	With external barrier liquid
	O	Without barrier liquid
Pos.	Code	Materials
(4)	A	PTFE-impregnated fibre packing rings and EPDM O-rings in the pump housing
	B	Graphite-PTFE compound packing rings and EPDM O-ring in the pump housing
	C	PTFE-impregnated fibre packing rings and FKM O-ring in the pump housing
	D	Graphite-PTFE compound packing rings and FKM O-ring in the pump housing

6. Construction

NB, centre-line outlet

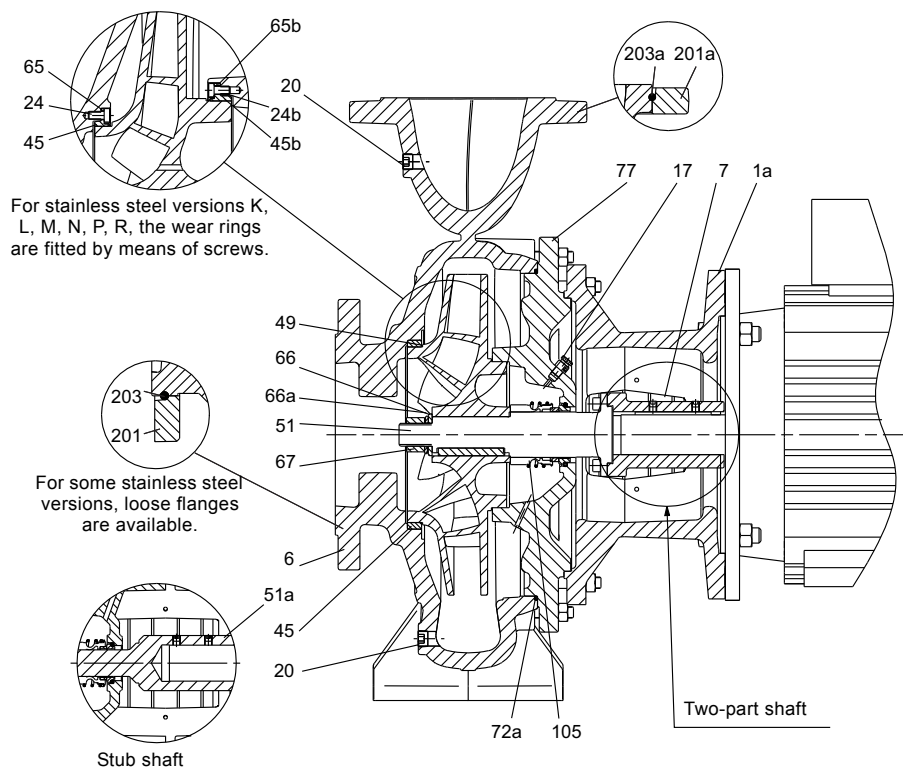

Fig. 6 Sectional drawing, centre-line outlet

NB, tangential outlet

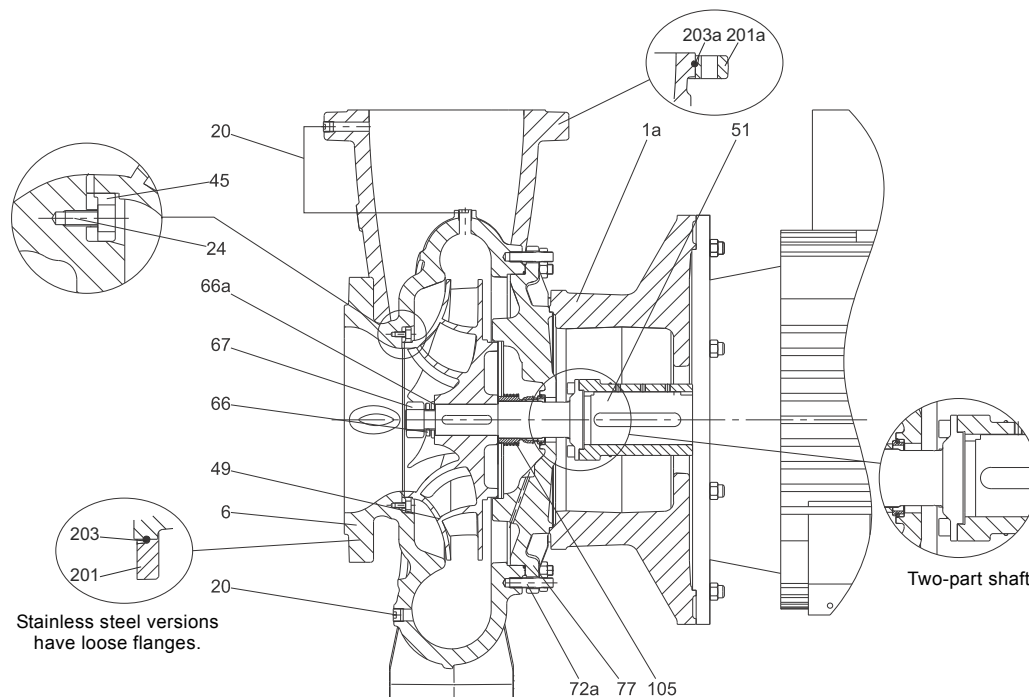
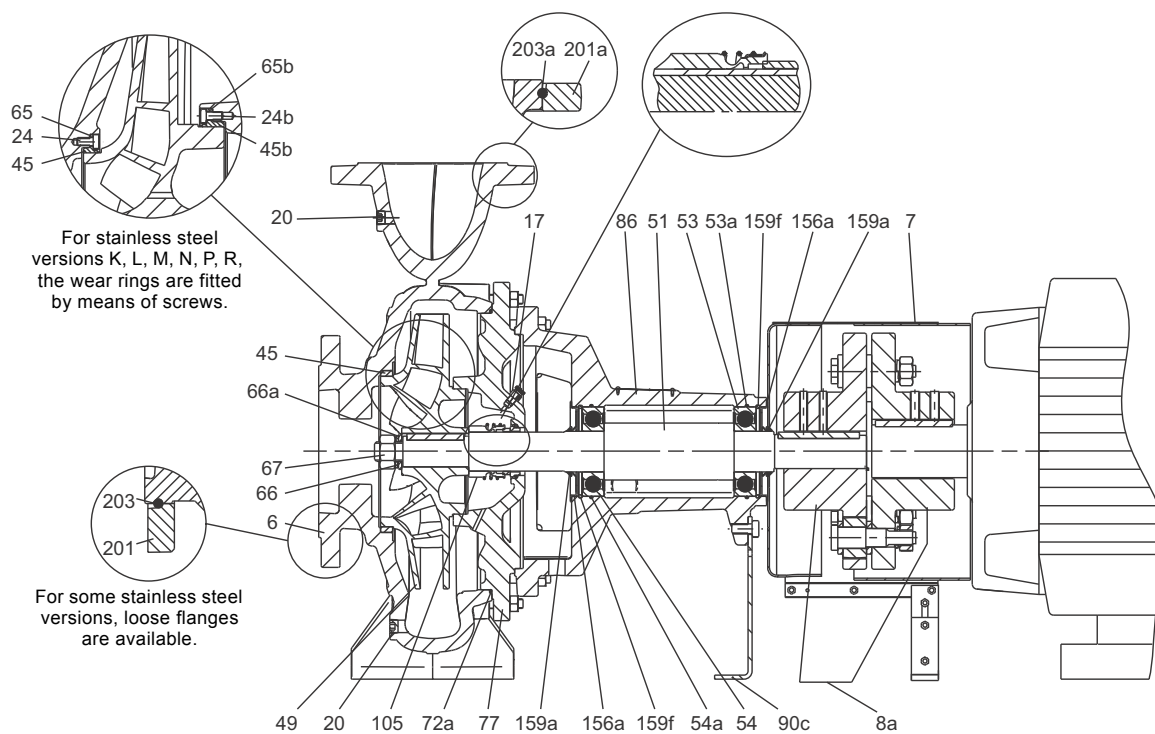

Fig. 7 Sectional drawing, tangential outlet, DN 200 and DN 250

TM06 7253 3216

TM05 1526 4617

NK, centre-line outlet



TM06 7239 1718

Fig. 8 Sectional drawing, centre-line outlet

NK, tangential outlet

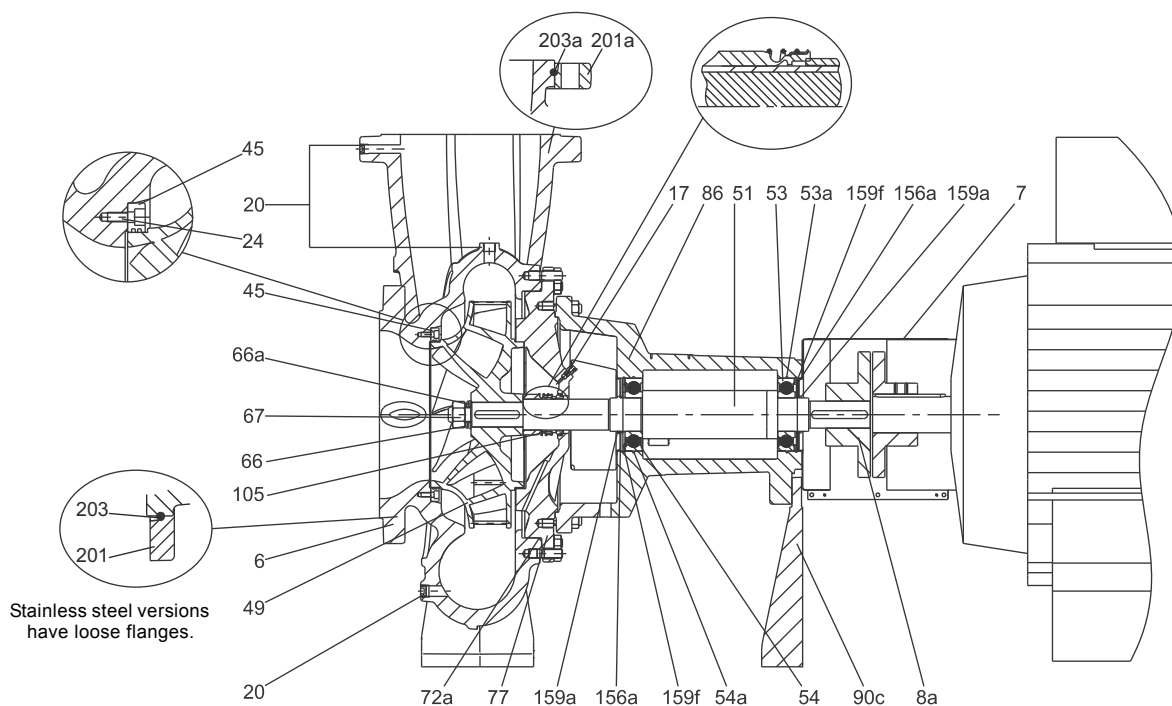

TM05 1528 1718

Fig. 9 Sectional drawing, with tangential outlet, DN 200 and DN 250

NK, stuffing box

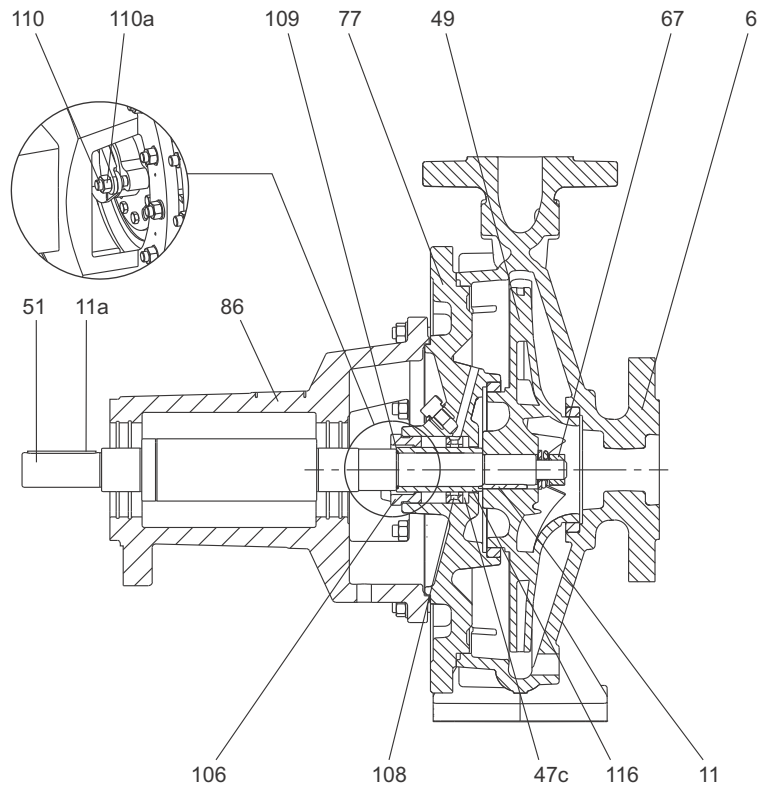

TM06 6931 2916

Fig. 10 Sectional drawing, stuffing box, single cover

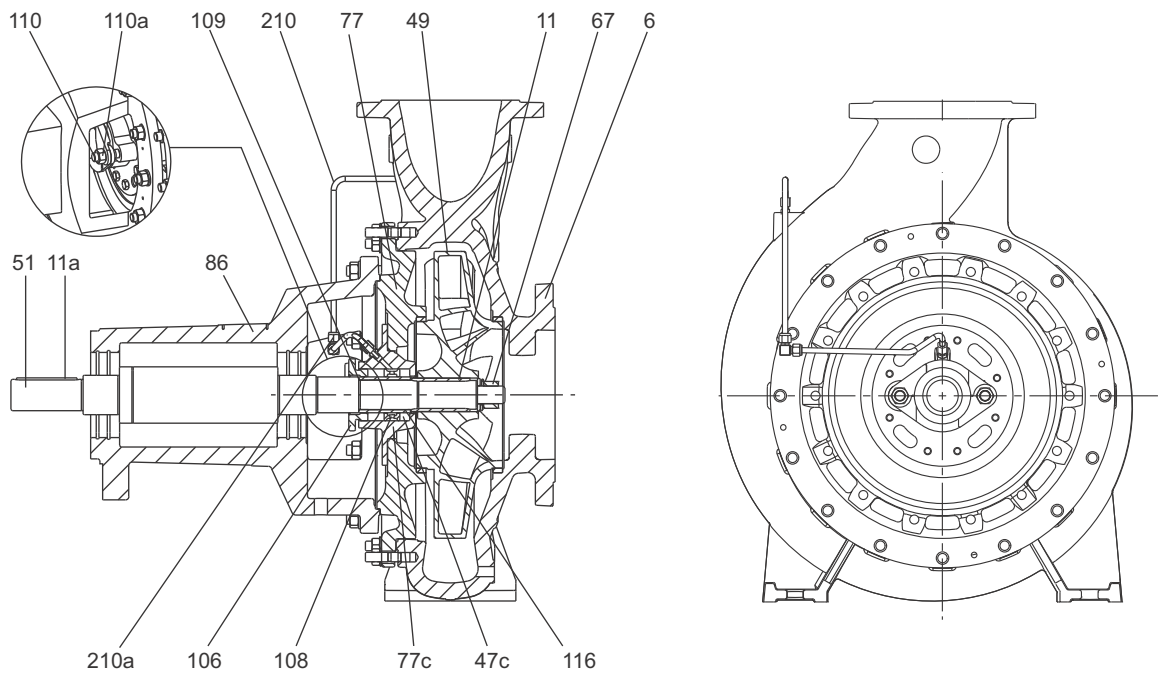

TM06 6932 3016

Fig. 11 Sectional drawing, stuffing box, split cover

Material specification, NK

Pos.	Description	Materials	Material code																				
			A	B	C	D	E	F	G	H	I	J	K	L	M	N	P	R	S	T	U	W	
6	Pump housing	EN-GJL-250	•	•	•	•	•	•	•	•	•	•	•	•	•	•	•	•	•	•	•	•	
		1.4408/CF8M	-	-	-	-	-	-	-	-	-	-	-	-	-	-	-	-	-	-	-	-	-
		1.4517/CD4MCuN	-	-	-	-	-	-	-	-	-	-	-	-	-	-	-	-	-	-	-	-	-
7	Coupling guard	1.4301/AISI 304	•	•	•	•	•	•	•	•	•	•	•	•	•	•	•	•	•	•	•	•	
8a	Coupling	See table below.	•	•	•	•	•	•	•	•	•	•	•	•	•	•	•	•	•	•	•	•	
11	Key	1.4401/AISI 316	•	•	•	•	•	•	•	•	•	•	•	•	•	•	•	•	•	•	•	•	
11a	Key	Steel	•	•	•	•	•	•	•	•	•	•	•	•	•	•	•	•	•	•	•	•	
17	Air vent plug	2.0401/CuZn44Pb2	•	•	•	•	•	•	•	•	•	•	•	•	•	•	•	•	•	•	•	•	
		1.4401/AISI 316	-	-	-	-	-	-	-	-	-	-	-	-	-	-	-	-	-	-	-	-	-
		1.4539/AISI 904L	-	-	-	-	-	-	-	-	-	-	-	-	-	-	-	-	-	-	-	-	-
20	Hexagon socket head plug	ISO 898 8.8 carbon steel	•	•	•	•	•	•	•	•	•	•	•	•	•	•	•	•	•	•	•	•	
		1.4401/AISI 316	-	-	-	-	-	-	-	-	-	-	-	-	-	-	-	-	-	-	-	-	-
		1.4539/AISI 904L	-	-	-	-	-	-	-	-	-	-	-	-	-	-	-	-	-	-	-	-	-
24	Hexagon socket head cap screw	1.4401/AISI 316	-	-	-	-	-	-	-	-	-	-	-	-	-	-	-	-	-	-	-	-	
		1.4539/AISI 904L	-	-	-	-	-	-	-	-	-	-	-	-	-	-	-	-	-	-	-	-	-
24b	Hexagon socket head cap screw	1.4401/AISI 316	-	-	-	-	-	-	-	-	-	-	-	-	-	-	-	-	-	-	-	-	
		1.4539/AISI 904L	-	-	-	-	-	-	-	-	-	-	-	-	-	-	-	-	-	-	-	-	-
45	Wear ring	CuSn10	•	•	•	•	•	•	•	•	•	•	•	•	•	•	•	•	•	•	•	•	
		CuZn34Mn3Al2Fe1-C	•	•	•	•	•	•	•	•	•	•	•	•	•	•	•	•	•	•	•	•	•
		EN-GJL-250	-	-	-	-	-	-	-	-	-	-	-	-	-	-	-	-	-	-	-	-	-
		1.4517/CD4MCuN	-	-	-	-	-	-	-	-	-	-	-	-	-	-	-	-	-	-	-	-	-
45b	Wear ring	Carbon-graphite-filled PTFE (Graflon®)	-	-	-	-	-	-	-	-	-	-	-	-	-	-	-	-	-	-	-	-	
		1.4517/CD4MCuN	-	-	-	-	-	-	-	-	-	-	-	-	-	-	-	-	-	-	-	-	-
47c	Packing ring	Buraflon®/Thermoflon®	•	•	•	•	•	•	•	•	•	•	•	•	•	•	•	•	•	•	•	•	
49	Impeller	EN-GJL-200	•	•	•	•	•	•	•	•	•	•	•	•	•	•	•	•	•	•	•	•	•
		CuSn10	-	-	-	-	-	-	-	-	-	-	-	-	-	-	-	-	-	-	-	-	-
		1.4408/CF8M	-	-	-	-	-	-	-	-	-	-	-	-	-	-	-	-	-	-	-	-	-
		1.4517/CD4MCuN	-	-	-	-	-	-	-	-	-	-	-	-	-	-	-	-	-	-	-	-	-
51	Shaft + Sleeve	1.4301 + 1.0503	•	•	•	•	•	•	•	•	•	•	•	•	•	•	•	•	•	•	•	•	
		1.4401	-	-	-	-	-	-	-	-	-	-	-	-	-	-	-	-	-	-	-	-	-
51	Shaft	1.4462	-	-	-	-	-	-	-	-	-	-	-	-	-	-	-	-	-	-	-	-	
		1.4462	-	-	-	-	-	-	-	-	-	-	-	-	-	-	-	-	-	-	-	-	-
53	Deep-groove ball bearings	2ZR.C3	•	•	•	•	•	•	•	•	•	•	•	•	•	•	•	•	•	•	•	•	
		Angular contact bearing	BECBJ (SKF)	•	•	•	•	•	•	•	•	•	•	•	•	•	•	•	•	•	•	•	•
53a	O-ring	EPDM/FKM	•	•	•	•	•	•	•	•	•	•	•	•	•	•	•	•	•	•	•	•	
54	Deep-groove ball bearings	2ZR.C3	•	•	•	•	•	•	•	•	•	•	•	•	•	•	•	•	•	•	•	•	
		Roller bearing	ECJ (SKF)	•	•	•	•	•	•	•	•	•	•	•	•	•	•	•	•	•	•	•	•
54a	O-ring	EPDM/FKM	•	•	•	•	•	•	•	•	•	•	•	•	•	•	•	•	•	•	•	•	
65	Wear ring retainer	1.4517/CD4MCuN	-	-	-	-	-	-	-	-	-	-	-	-	-	-	-	-	-	-	-	-	
65b	Wear ring retainer	1.4517/CD4MCuN	-	-	-	-	-	-	-	-	-	-	-	-	-	-	-	-	-	-	-	-	
66	Washer	1.4301/AISI 304	•	•	•	•	•	•	•	•	•	•	•	•	•	•	•	•	•	•	•	•	
		1.4401/AISI 316	-	-	-	-	-	-	-	-	-	-	-	-	-	-	-	-	-	-	-	-	-
		1.4539/AISI 904L	-	-	-	-	-	-	-	-	-	-	-	-	-	-	-	-	-	-	-	-	-
66a	Spring lock washer	1.4301/AISI 304	•	•	•	•	•	•	•	•	•	•	•	•	•	•	•	•	•	•	•	•	
		1.4401/AISI 316	-	-	-	-	-	-	-	-	-	-	-	-	-	-	-	-	-	-	-	-	-
		1.4539/AISI 904L	-	-	-	-	-	-	-	-	-	-	-	-	-	-	-	-	-	-	-	-	-
67	Impeller nut	1.4301/AISI 304	•	•	•	•	•	•	•	•	•	•	•	•	•	•	•	•	•	•	•	•	
		1.4401/AISI 316	-	-	-	-	-	-	-	-	-	-	-	-	-	-	-	-	-	-	-	-	-
		1.4539/AISI 904L	-	-	-	-	-	-	-	-	-	-	-	-	-	-	-	-	-	-	-	-	-
72a	O-ring	E / F / K / M / V / X	•	•	•	•	•	•	•	•	•	•	•	•	•	•	•	•	•	•	•	•	
77	Cover	EN-GJL-250	•	•	•	•	•	•	•	•	•	•	•	•	•	•	•	•	•	•	•	•	
		1.4408/CF8M	-	-	-	-	-	-	-	-	-	-	-	-	-	-	-	-	-	-	-	-	-
		1.4517/CD4MCuN	-	-	-	-	-	-	-	-	-	-	-	-	-	-	-	-	-	-	-	-	-
77c	Packing housing	1.4517/CD4MCuN	-	-	-	-	-	-	-	-	-	-	-	-	-	-	-	-	-	-	-	-	
		Cast iron	•	•	•	•	•	•	•	•	•	•	•	•	•	•	•	•	•	•	•	•	•
86	Bearing bracket	1.4408	-	-	-	-	-	-	-	-	-	-	-	-	-	-	-	-	-	-	-	-	
		1.4408	-	-	-	-	-	-	-	-	-	-	-	-	-	-	-	-	-	-	-	-	-
90c	Foot	EN-GJL-250/1.0338/carbon steel DC04	•	•	•	•	•	•	•	•	•	•	•	•	•	•	•	•	•	•	•	•	
105	Shaft seal	Burgmann 1.4401/AISI 316	•	•	•	•	•	•	•	•	•	•	•	•	•	•	•	•	•	•	•	•	
		Burgmann 2.4610/Hastelloy C-4	-	-	-	-	-	-	-	-	-	-	-	-	-	-	-	-	-	-	-	-	-
106	Gland	Cu42Si10	•	•	•	•	•	•	•	•	•	•	•	•	•	•	•	•	•	•	•	•	
		1.4408	•	•	•	•	•	•	•	•	•	•	•	•	•	•	•	•	•	•	•	•	•
		1.4517	-	-	-	-	-	-	-	-	-	-	-	-	-	-	-	-	-	-	-	-	-
108	Distribution ring	1.4301	•	•	•	•	•	•	•	•	•	•	•	•	•	•	•	•	•	•	•	•	
		1.4462	-	-	-	-	-	-	-	-	-	-	-	-	-	-	-	-	-	-	-	-	-
109	O-ring	EPDM/FKM	•	•	•	•	•	•	•	•	•	•	•	•	•	•	•	•	•	•	•	•	
110	Bolt	A2-70	•	•	•	•	•	•	•	•	•	•	•	•	•	•	•	•	•	•	•	•	

Pos.	Description	Materials	Material code																				
			A	B	C	D	E	F	G	H	I	J	K	L	M	N	P	R	S	T	U	W	
110a	Nut	A2-70	•	•	•	•	•	•	•	•	•	•	•	•	•	•	•	•	•	•	•	•	
116	Shaft sleeve	1.4034/1.4021	•	•	•	•	•	•	•	-	-	-	-	-	-	-	-	-	•	•	-	-	
		1.4404/1.4401	-	-	-	-	-	-	-	-	•	•	•	•	•	•	•	•	•	•	•	•	•
		1.4462	-	-	-	-	-	-	-	-	-	-	•	-	-	-	-	-	•	-	-	-	-
156a	Cover, bearing	1.0338/carbon steel DC04	•	•	•	•	•	•	•	•	•	•	•	•	•	•	•	•	•	•	•	•	
159a	Thrower	EPDM	•	•	•	•	•	•	•	•	•	•	•	•	•	•	•	•	•	•	•	•	
159f	Locking ring, circlip	DIN 472 (C75 DIN 17 222)	•	•	•	•	•	•	•	•	•	•	•	•	•	•	•	•	•	•	•	•	
201	Loose flange, inlet	GGG50/1.4408/ASTM CF8M	-	-	-	-	-	-	-	•	•	•	•	•	•	•	•	•	•	-	-	•	
201a	Loose flange, outlet	GGG50/1.4408/ASTM CF8M	-	-	-	-	-	-	-	•	•	•	•	•	•	•	•	•	•	-	-	•	
203	Retainer, inlet	1.4310	-	-	-	-	-	-	-	•	•	•	•	•	•	•	•	•	•	-	-	•	
203a	Retainer, outlet	1.4310	-	-	-	-	-	-	-	•	•	•	•	•	•	•	•	•	•	-	-	•	
210	Flushing pipe	1.4401	•	•	•	•	•	•	•	•	•	•	•	•	•	•	•	•	•	•	•	•	
		1.4462	-	-	-	-	-	-	-	-	-	-	-	-	-	-	-	-	-	•	-	-	-
210a	Compression fitting	1.4401	•	•	•	•	•	•	•	•	•	•	•	•	•	•	•	•	•	•	•	•	
		1.4462	-	-	-	-	-	-	-	-	-	-	-	-	-	-	-	-	-	•	-	-	-

Material of coupling (8a)

Coupling type	Poles	Motor size	Material
Standard coupling	2	Up to 22 kW	EN-GJL-250
		From 30 kW	EN-GJS-450-10
	4	Up to 30 kW	EN-GJL-250
		From 37 kW	EN-GJS-450-10
	6	Up to 37 kW	EN-GJL-250
		From 45 kW	EN-GJS-450-10
Spacer coupling	All	All	EN-GJL-250

Note: Other configurations are available on request. Please contact Grundfos.

Mechanical construction

Mounting design, NB

NB pumps come in these mounting designs:

Mounting design A: pump housing with feet

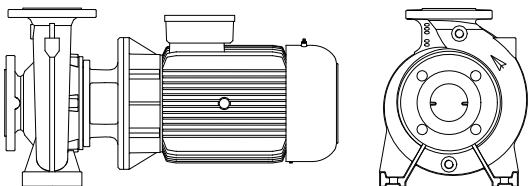

Fig. 12 Mounting design A

TM02 5509 3402

Mounting design B: motor with feet

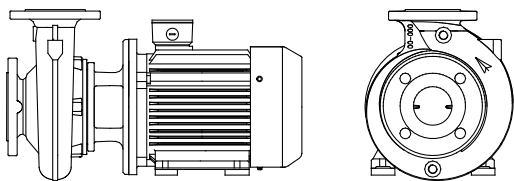

Fig. 13 Mounting design B

TM02 5510 3402

Mounting design C: pump housing and motor with feet

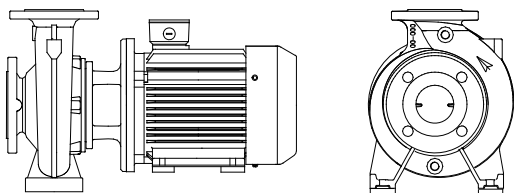

Fig. 14 Mounting design C

TM02 5511 3402

Mounting design F: design C with base frame.

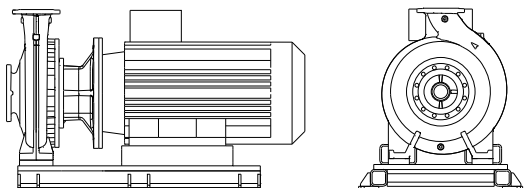

Fig. 15 Mounting design F

TM04 0483 3402

Pump housing

The volute pump housing has an axial inlet port and a radial outlet centre-line port. Flange dimensions are in accordance with EN 1092-2.

For DN 200 outlet and above, the outlet port is tangential.

The pump houses have both a priming and a drain hole closed by plugs.

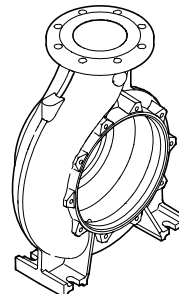

Fig. 16 NB and NK pump housing with centre-line outlet

TM03 0232 4504

Bearing bracket and shaft, NK

The bearing bracket has two sturdy anti-friction, lubricated-for-life bearings.

The bearing bracket is made of cast iron EN-GJL-250.

The shaft is made of stainless steel. Shaft diameter d_5 is either $\varnothing 24$, $\varnothing 32$, $\varnothing 42$, $\varnothing 48$ or $\varnothing 60$ where the coupling is mounted.

A thrower on the shaft prevents liquid from entering the bearing bracket. In stuffing box versions, the shaft is protected by a stainless steel sleeve.

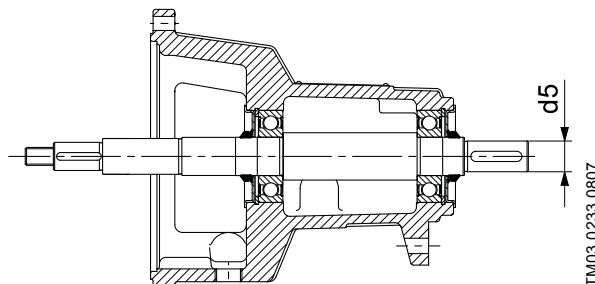

Fig. 17 Bearing bracket and shaft

TM03 0233 0807

All NK pumps are fitted with one of five shaft, shaft seal and bearing sizes. As the bearings and shafts are large, the NK pumps can be driven by a belt drive or a diesel engine, if required.

For prolonged lifetime and to suit high inlet pressure, heavy duty bearing brackets are available. See the data booklet "NB, NBG, NK, NKG, NBE, NBGE, NKE, NKGE - Custom-built pumps according to EN 733 and ISO 2858", or contact Grundfos.

Stuffing boxes, NK

Stuffing boxes are available as pure packing rings or as packing rings with graphite seals. Stuffing box packing rings with graphite seals have proven their qualities in a wide range of applications, especially under extreme conditions, such as high pressure or high temperature, or operation with oils or aggressive liquids.

Braided material is effective for ensuring long service life for packing rings while protecting the shaft sleeve when used in pumps. When fitted, these packing rings are symmetrical, having parallel facings that rule out tilting.

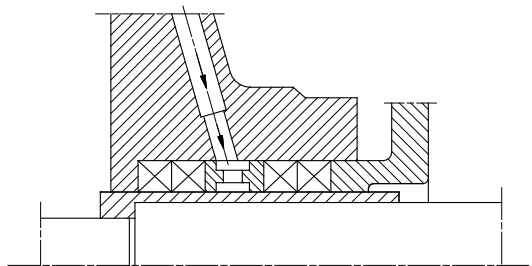

TM00 2584 0597

Fig. 18 Uncooled stuffing box, type SNE(x), with internal barrier liquid for the pumping of clean liquids in suction operation or at inlet pressures up to 4 bar

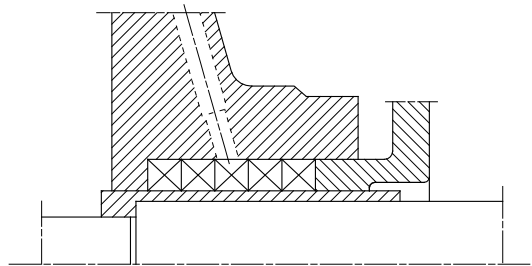

TM00 2585 0597

Fig. 19 Uncooled stuffing box, type SNO(x), without internal barrier liquid for the pumping of clean liquids in suction operation or at inlet pressures over 4 bar

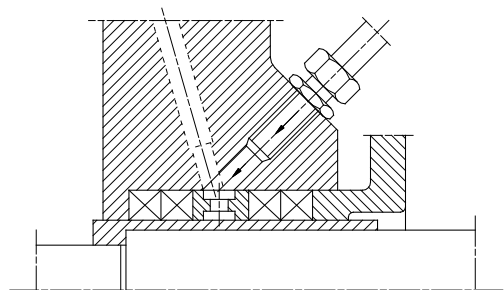

TM00 2586 0597

Fig. 20 Uncooled stuffing box, type SNF(x), with external barrier liquid for the pumping of contaminated and malodorous liquids and for applications with continuous vacuum on the inlet (constant inlet pressure below atmosphere pressure)

Pump cover design

Material code	A/B/C/D/E/F/G/H/S/T	I/J/K/L/M/N/P/R/U/W
Pump shaft diameter d5 [mm]	Pump cover design	
24	Single ¹	Split ²
32	Single ¹	Split ²
42	Single ¹	Split ²
48	Split ²	Split ²
60	Split ²	Split ²

¹ See fig. 10.

² See fig. 11.

Motor stool and cover, NB

The cover is provided with a manual air vent screw for the venting of the pump housing and the shaft seal chamber. An O-ring forms the seal between cover and pump housing.

Coupling guards are fitted to the motor stool.

The mounting designations of motors for NB, NBE are as follows:

- IM B5: Up to and including frame size 132.
- IM B35: As from frame size 160 and upwards.

The flange size of the motor stool is according to IEC 60034.

Shaft, NB

The stainless steel shaft is Ø28, Ø38, Ø48, Ø55 or Ø60 where the shaft seal is mounted.

The coupling end of the shaft is cylindrical and has two drilled holes for the set screws of the coupling.

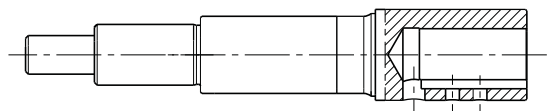

TM02 9500 2704

Fig. 21 Stub shaft, NB pump

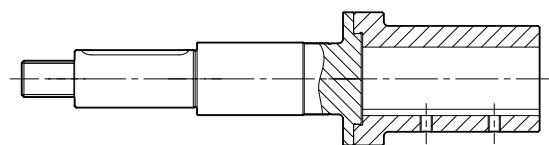

TM03 6393 3506

Fig. 22 2-part stub shaft, NB pump

Coupling, NK

NK pumps are available with two types of coupling:

- standard coupling
- spacer coupling.

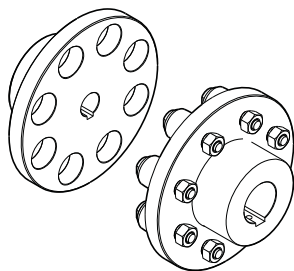

Fig. 23 Standard coupling

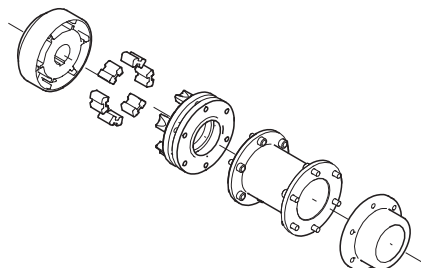

Fig. 24 Spacer coupling

Pumps fitted with a spacer coupling can be serviced without dismantling the motor from the base frame and without removing the pump housing from the pipes. This saves realignment of pump and motor after service.

For couplings for ATEX-approved pumps, see the data booklet "NB, NBG, NK, NKG, NBE, NBGE, NKE, NKGE - Custom-built pumps according to EN 733 and ISO 2858".

Impeller

The impeller is a closed impeller with double-curved blades with smooth surfaces. This ensures high efficiency.

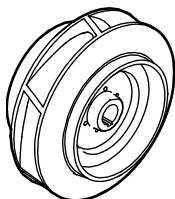

Fig. 25 Impeller, NB and NK pumps

All impellers are statically and hydraulically balanced. The hydraulic balancing compensates for axial thrust. The direction of rotation of the impeller is clockwise when viewed from the motor.

All impellers can be adapted to the duty point as requested by the customer.

Base frame, NK

NK pumps are available with two types of base frame.

EN/ISO base frame

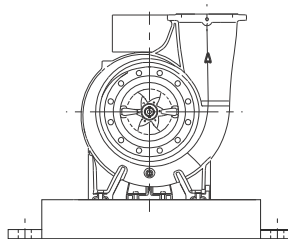

Fig. 26 Schematic view of NK pump mounted on an EN/ISO base frame

Pump and motor are mounted on a common steel base frame in accordance with EN 23661. The largest base frames, larger than size 9, are not described in any standard and therefore not in accordance with EN 23661.

The base frame may be longer than the pump and motor.

An EN/ISO base frame prepared for grouting is available as an option. See fig. 46 on page 52.

C-channel base frame

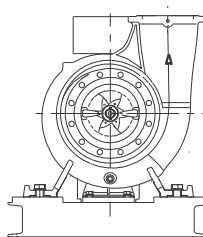

Fig. 27 Schematic view of NK pump mounted on a C-channel base frame

Pump and motor are mounted on a common steel base frame optimised for the length of the pump and motor. Dimensions are not in accordance with EN 23661. All C-channel base frames can be grouted.

Surface treatment

NB and NK

The cast iron parts of NB and NK pumps have an epoxy-based coating made in a cathodic electro-deposition CED process. CED is a high-quality dip-painting process where an electrical field around the products ensures deposition of paint particles as a thin, well-controlled layer on the surface. An integral part of the process is a pretreatment. The entire process consists of these elements:

1. alkaline-based cleaning
2. zinc phosphating
3. cathodic electro-deposition
4. curing to a dry film thickness of 18-22 µm.

The colour code for the finished product is NCS 9000/AL 9005.

For low-temperature applications at high humidity, Grundfos offers NB and NK pumps with extra surface treatment to avoid corrosion. These pumps are available on request.

Test pressure

Pressure testing was made with 20 °C water containing corrosion inhibitor.

Pressure stage	Operating pressure		Test pressure	
	[bar]	[MPa]	[bar]	[MPa]
PN 10	10	1.0	15	1.5
PN 16	16	1.6	24	2.4
PN 25	25	2.5	37.5	3.75

Motors and drives

For NB, NBE, NK, NKE pumps Grundfos can provide a wide range of motors and drives within these two main categories:

- standard motors
- speed-controlled motors.

Standard motors are mains-operated whereas the speed-controlled motors can be started and operated in various ways.

The speed-controlled NB, NK pumps can be driven in two ways:

- by a standard motor with an external frequency converter. The frequency converter can be a Grundfos CUE solution or another make.
- by a motor with an integrated frequency converter, a Grundfos MGE motor.

Standard motors

The motor is a totally enclosed, fan-cooled standard motor with main dimensions according to IEC and DIN standards. Electrical tolerances are to IEC 60034.

Standard motor ranges

The table shows the range of standard motors currently used for NB, NK pumps. The motors stated in section [17. Dimensional drawings and technical data](#) are MG and Siemens motors.

IE class	Motor	Poles	P2 [kW]																													
			0.25	0.37	0.55	0.75	1.1	1.5	2.2	3	4	5.5	7.5	11	15	18.5	22	30	37	45	55	75	90	110	132	160	200	250	315	355		
IE1	MG	4	•	•	•	-	-	-	-	-	-	-	-	-	-	-	-	-	-	-	-	-	-	-	-	-	-	-	-	-	-	-
		2	-	-	•	•	•	•	•	•	•	•	•	•	•	•	•	•	•	•	•	•	•	•	•	•	•	•	•	•	•	•
	MMG-G	4	-	•	•	•	•	•	•	•	•	•	•	•	•	•	•	•	•	•	•	•	•	•	•	•	•	•	•	•	•	•
		6	-	•	•	•	•	•	•	•	•	•	•	•	•	•	•	•	•	•	•	•	•	•	•	•	•	•	•	•	•	•
		2	-	•	•	•	•	•	•	•	•	•	•	•	•	•	•	•	•	•	•	•	•	•	•	•	•	•	•	•	•	•
		4	•	•	•	•	•	•	•	•	•	•	•	•	•	•	•	•	•	•	•	•	•	•	•	•	•	•	•	•	•	•
IE2	MMG-G	4	-	•	•	•	•	•	•	•	•	•	•	•	•	•	•	•	•	•	•	•	•	•	•	•	•	•	•	•	•	
		6	-	•	•	•	•	•	•	•	•	•	•	•	•	•	•	•	•	•	•	•	•	•	•	•	•	•	•	•	•	•
		2	-	•	•	•	•	•	•	•	•	•	•	•	•	•	•	•	•	•	•	•	•	•	•	•	•	•	•	•	•	•
		4	•	•	•	•	•	•	•	•	•	•	•	•	•	•	•	•	•	•	•	•	•	•	•	•	•	•	•	•	•	•
	MMG-H2	4	•	•	•	•	•	•	•	•	•	•	•	•	•	•	•	•	•	•	•	•	•	•	•	•	•	•	•	•	•	•
		6	-	•	•	•	•	•	•	•	•	•	•	•	•	•	•	•	•	•	•	•	•	•	•	•	•	•	•	•	•	•
IE3	MG	2	-	•	•	•	•	•	•	•	•	•	•	•	•	•	•	•	•	•	•	•	•	•	•	•	•	•	•	•	•	
		4	-	•	•	•	•	•	•	•	•	•	•	•	•	•	•	•	•	•	•	•	•	•	•	•	•	•	•	•	•	•
	Siemens	2	-	•	•	•	•	•	•	•	•	•	•	•	•	•	•	•	•	•	•	•	•	•	•	•	•	•	•	•	•	•
		4	-	•	•	•	•	•	•	•	•	•	•	•	•	•	•	•	•	•	•	•	•	•	•	•	•	•	•	•	•	•
		6	-	•	•	•	•	•	•	•	•	•	•	•	•	•	•	•	•	•	•	•	•	•	•	•	•	•	•	•	•	•
		2	-	•	•	•	•	•	•	•	•	•	•	•	•	•	•	•	•	•	•	•	•	•	•	•	•	•	•	•	•	•
MMG-E	4	•	•	•	•	•	•	•	•	•	•	•	•	•	•	•	•	•	•	•	•	•	•	•	•	•	•	•	•	•	•	
	6	-	•	•	•	•	•	•	•	•	•	•	•	•	•	•	•	•	•	•	•	•	•	•	•	•	•	•	•	•	•	
	2	-	•	•	•	•	•	•	•	•	•	•	•	•	•	•	•	•	•	•	•	•	•	•	•	•	•	•	•	•	•	
	4	•	•	•	•	•	•	•	•	•	•	•	•	•	•	•	•	•	•	•	•	•	•	•	•	•	•	•	•	•	•	
MMG-H3	2	-	•	•	•	•	•	•	•	•	•	•	•	•	•	•	•	•	•	•	•	•	•	•	•	•	•	•	•	•	•	
	4	-	•	•	•	•	•	•	•	•	•	•	•	•	•	•	•	•	•	•	•	•	•	•	•	•	•	•	•	•	•	
IE4	Siemens	2	-	•	•	•	•	•	•	•	•	•	•	•	•	•	•	•	•	•	•	•	•	•	•	•	•	•	•	•	•	
		4	-	•	•	•	•	•	•	•	•	•	•	•	•	•	•	•	•	•	•	•	•	•	•	•	•	•	•	•	•	•

Grey background: Outside definition of IE class

Note: Not all motor makes are available worldwide. For specific information about the motor makes available in your region, contact your Grundfos Customer Service Unit (CSU).

Speed-controlled standard motors

General considerations

If you connect an external frequency converter to your standard motor, the motor insulation is exposed to higher voltage peaks due to the operation of the frequency converter. This causes the motor to be more noisy than in normal operation. In addition, large motors are exposed to bearing currents caused by the frequency converter.

If you operate the motor via a frequency converter, consider the following:

- In 2-, 4- and 6-pole motors, frame size 225 and up, isolate one of the motor bearings electrically to prevent damaging currents from passing through the motor bearings.
- In noise-sensitive applications, you can reduce the motor noise by fitting a dU/dt filter between the motor and the frequency converter. For particularly noise-sensitive applications, we recommend a sinusoidal filter.
- The length of the cable between motor and frequency converter affects the motor load. Therefore, check that the cable length meets the specifications laid down by the frequency converter supplier.
- For supply voltages between 500 and 690 V, fit a dU/dt filter to reduce voltage peaks, or use a motor with reinforced insulation.
- For supply voltages of 690 V, use a motor with reinforced insulation, and fit a dU/dt filter.

Grundfos CUE

NB, NK pumps connected to Grundfos CUE external frequency converters



GRA 4404

Fig. 28 Grundfos CUE frequency converters

Grundfos CUE is a complete range of wall-mounted frequency converters for pump control in a wide range of applications.

Grundfos CUE provides a variety of benefits to the end-user, such as:

- Grundfos E-pump functionality and user interface
- application- and pump family-related functions
- increased comfort compared to fixed-speed pump solutions
- simple installation and commissioning compared to standard frequency converters
- speed control of pumps up to 250 kW.

Intuitive startup guide

The startup guide enables easy installation and commissioning as well as plug-and-pump convenience. Few settings need to be made by the installer as the rest is done automatically or preset from the factory.

Smart user interface



TM04 3283 4108

Fig. 29 Grundfos CUE user interface

Grundfos CUE features a unique user-friendly operating panel with graphic display and easy-to-use buttons.

Controlling the selected parameter

Grundfos CUE has a built-in PI controller offering closed-loop control of these parameters:

- constant differential pressure
- proportional pressure
- constant temperature
- constant flow rate.

Wide product range

The CUE product range is quite comprehensive, covering five different voltage ranges, enclosure classes IP20/21 (NEMA 1) and IP54/55 (NEMA 12), and a wide range of output powers.

The table below provides a general overview.

Input voltage [V]	Output voltage [V]	Motor [kW]
1 x 200-240	3 x 200-240	1.1 - 7.5
3 x 200-240	3 x 200-240	0.75 - 4.5
3 x 380-500	3 x 380-500	0.55 - 250
3 x 525-600	3 x 525-600	0.75 - 7.5
3 x 525-690	3 x 525-690	11-250

External communication

Grundfos CUE can communicate by means of LON, PROFIBUS, Modbus or BACnet via Grundfos CIU.

Grundfos MGE motors

IE2 IE3 IE5

NBE, NKE pumps with a motor with an integrated frequency converter



Fig. 30 NBE and NKE pumps

The MGE motor is a totally enclosed, fan-cooled, frequency-controlled motor with dimensions according to IEC and DIN standards. Electrical tolerances are to IEC 60034.

Motor protection

The motor requires no external motor protection. MGE motors incorporate thermal protection against steady overload and stalled condition (IEC 34-11: TP 211).

Benefits

Grundfos MGE motors provide a variety of benefits to the end-user, such as:

- Grundfos E-pump functionality and user interface
- a perfect match between pump and frequency drive
- application- and pump family-related functions
- increased comfort compared to fixed-speed pump solutions
- simple installation and commissioning compared to standard frequency converters.

Smart user interface



Fig. 31 MGE user interface

Grundfos MGE motors feature a user-friendly operating panel with easy-to-use buttons.

Controlling the selected parameter

Grundfos MGE has a built-in PI controller offering closed-loop control of these parameters:

- constant differential pressure
- proportional pressure
- constant temperature
- constant flow rate.

MGE motor range

Pole	IE class	P2 [kW]													
		0.55	0.75	1.1	1.5	2.2	3	4	5.5	7.5	11	15	18.5	22	
2	IE2	-	-	-	-	-	-	-	-	-	-	-	-	-	-
	IE3	-	-	-	-	-	-	-	-	-	-	-	-	-	-
	IE5	-	-	•	•	•	•	•	•	•	•	•	•	•	•
4	IE2	-	-	-	-	-	-	-	-	-	-	-	-	-	-
	IE3	-	-	-	-	-	-	-	-	-	-	-	-	-	-
	IE5	•	•	•	•	•	•	•	•	•	•	•	•	•	•

Outside definition of IE class

External communication

Grundfos MGE can communicate by means of LON, PROFIBUS, Modbus or BACnet as described in section [Communication with E-pumps](#), on page 60.

Optional motors

The Grundfos standard range of motors covers a wide variety of application requirements. However, for special applications or operating conditions, custom-built motor solutions can be provided.

For special applications or operating conditions, Grundfos offers custom-built motors such as:

- ATEX-approved motors
- MG motors with anti-condensation heating unit
- motors with thermal protection.

TM03 0302 4704

TM07 1098 1018
TM07 1097 1018

7. Operating conditions

Pump location

The pump is designed for installation in a non-aggressive and non-explosive atmosphere. The relative air humidity must not exceed 95 %.

Ambient temperature and installation altitude

The ambient temperature and the installation altitude are important factors for the motor life, as they affect the life of the bearings and the insulation system. The installation altitude is the height of the installation site above sea level.

If the ambient temperature exceeds the recommended maximum ambient temperature or maximum altitude above sea level, see fig. 32, the motor must not be fully loaded due to the low density and consequently low cooling effect of the air. In such cases, it may be necessary to use a motor with a higher output.

Pump with standard motor

Ambient temperature

Motor make	Motor P2	Permissible ambient temperature
MG	0.25 - 0.55 kW	-20 to +40 °C
	0.75 - 22 kW	-20 to +60 °C
Siemens	0.75 - 462 kW	-20 to +55 °C
MMG-H2	0.75 - 450 kW	-20 to +60 °C
MMG-H3	0.75 - 200 kW	-30 to +60 °C

Maximum motor output in relation to ambient temperature and altitude

Motor make	Motor P2	Derating curve
MG	0.25 - 0.55 kW	Fig. 32, curve 1
	0.75 - 22 kW	Fig. 32, curve 2
Siemens	0.75 - 462 kW	Fig. 32, curve 3
MMG-H2	0.75 - 450 kW	Fig. 32, curve 2
MMG-H3	0.75 - 200 kW	Fig. 32, curve 2

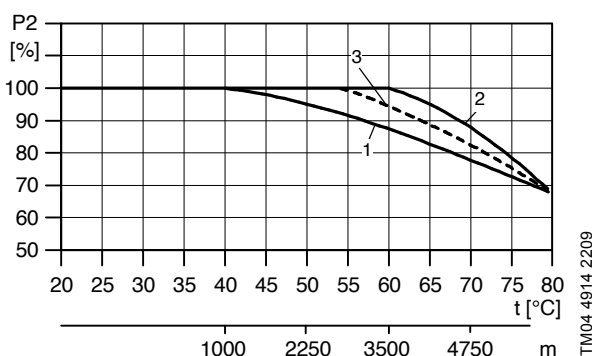

Fig. 32 Maximum motor output in relation to ambient temperature and altitude

Example with a pump with a 1.1 kW IE3 MG motor: If the pump is installed 4750 m above sea level, the motor must not be loaded more than 88 % of rated output. At an ambient temperature of 75 °C, the motor must not be loaded more than 78 % of rated output. If the pump is installed 4750 m above sea level at an ambient temperature of 75 °C, the motor must not be loaded more than 88 % x 78 % equal to 68.6 % of the rated output.

Pump with Grundfos MGE motor

Ambient temperature

Motor make	Motor P2	Permissible ambient temperature
Grundfos MGE	1.1 - 11 kW, 2-pole	-20 to +50 °C
	15-22 kW, 2-pole	-20 to +40 °C
	0.55 - 7.5 kW, 4-pole	-20 to +50 °C
	11 - 18.5 kW, 4-pole	-20 to +40 °C

The motor can operate with the rated power output, P2, at 50 °C, but continuous operation at higher temperatures reduces the expected product life. If the motor is to operate at ambient temperatures between 50 and 60 °C, select an oversize motor.

Contact Grundfos for further information.

Installation altitude

Motors installed up to 1000 metres above sea level can be loaded 100 %.

Motors installed more than 1000 metres above sea level must not be fully loaded due to the low density and consequent low cooling effect of the air.

Installation altitude is the height above sea level of the installation site.

Motors installed up to 1000 m above sea level can be loaded 100 %.

The motors can be installed up to 3500 m above sea level.

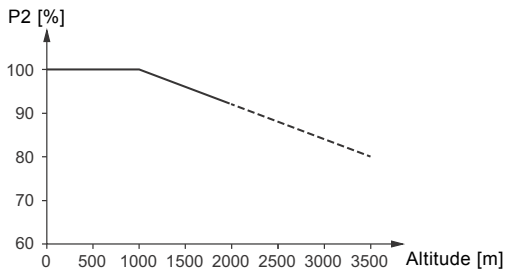

Fig. 33 Motor output power in relation to altitude

In order to maintain the galvanic isolation and ensure correct clearance according to EN 60664-1:2007, you must adapt the supply voltage to the altitude:

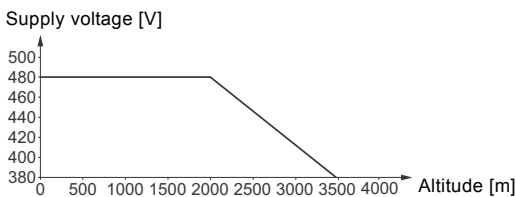

Fig. 34 Supply voltage for three-phase motor in relation to altitude

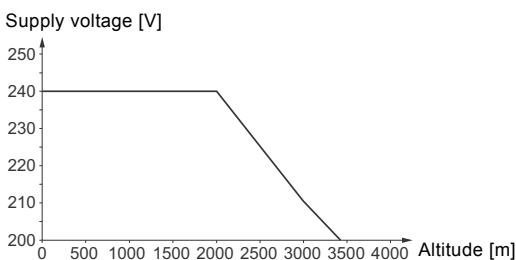

Fig. 35 Supply voltage for single-phase motor in relation to altitude

Note:

If the motor is to operate at ambient temperatures between 50 and 60 °C, select an oversized motor. Contact Grundfos.

Flow rates

Minimum flow rate

The pump must not run against a closed outlet valve as this causes an increase in temperature or formation of steam in the pump. This may cause shaft damage, impeller erosion, short life of bearings, damage to stuffing boxes or mechanical shaft seals due to stress or vibration.

The continuous flow rate must be at least 10 % of the maximum flow rate.

Maximum flow rate

The maximum flow rate must not be exceeded as otherwise there is a risk of for instance cavitation and overload.

The maximum flow rate can be read either from the performance curve pages or from a curve on a specific pump when selecting it in Grundfos Product Center.

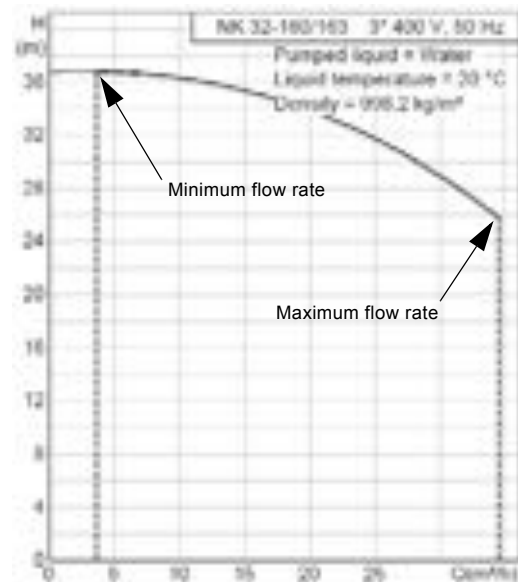

Fig. 36 Example from Grundfos Product Center showing minimum and maximum flow rate

Sound pressure level

Data in this table apply to pump including motor.

Motor [kW]	Maximum sound pressure level [dB(A)] - ISO 3743		
	Three-phase motors		
	2-pole	4-pole	6-pole
0.25	56	41	-
0.37	56	45	-
0.55	57	42	40
0.75	56	42	43
1.1	59	50	43
1.5	58	50	47
2.2	60	52	52
3	67	58	63
4	69	58	63
5.5	68	64	63
7.5	68	64	67
11	70	65	67
15	70	65	57
18.5	70	57	57
22	67	57	57
30	67	57	57
37	67	57	57
45	67	57	58
55	71	57	58
75	73	65	59
90	73	65	59
110	73	65	60
132	73	65	60
160	76	65	63
200	76	65	67
250	78	73	68
315	82	74	71
355	77	75	71
400	-	75	-

Liquid temperatures

Liquids with temperatures ranging from -25 to +140 °C are covered in this data booklet.

For liquids from -40 to +220 °C, see the data booklet "NB, NBG, NK, NKG, NBE, NBGE, NKE, NKGE - Custom-built pumps according to EN 733 and ISO 2858", or contact Grundfos. In that data booklet, you will also find information about the seals being used for other liquids than water and glycols, i.e. oils, chemicals and silicone oil. Further seal types are also described to support more application types and pumped liquids.



The maximum liquid temperature is stamped on the nameplate.

Note that the maximum liquid temperature limits stated by Grundfos may be overruled by local regulations and various laws.

Operating range of mechanical shaft seals

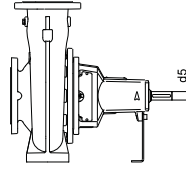
The temperature range applies to water and coolants. Seals with a temperature range of 0 °C and up are mainly used for pumping water, while seals for temperatures below 0 °C are mainly intended for coolants.



Shaft seal diameter [mm]	NB, NK	28, 38	48	55	60			
d5 [mm]	NK	24, 32	42	48	60			
Shaft seal type	Code	Temperature range	Maximum pressure [bar]				Seal faces	Rubber
 Bellows seal, type B, unbalanced	BAQE	0-120 °C	16	16	16	16	AQ ₁	EPDM
	BAQV	0-90 °C	16	16	16	16	AQ ₁	FKM
	BBQE	0-120 °C	16	16	16	16	BQ ₁	EPDM
	BBQV	0-90 °C	16	16	16	16	BQ ₁	FKM
	BQQE	-25 to +120 °C	16	16	16	16	Q ₇ Q ₇	EPDM
	BQQV	-10 to +90 °C	16	16	16	16	Q ₇ Q ₇	FKM
 O-ring seal, type A, unbalanced	AQAE	0-120 °C	16	16	16	16	Q ₁ A	EPDM
	AQAV	0-90 °C	16	16	16	16	Q ₁ A	FKM
	AQQE	-25 to +90 °C	16	16	16	16	Q ₁ Q ₁	EPDM
	AQQV	-10 to +90 °C	16	16	16	16	Q ₁ Q ₁	FKM
	AQQX	-15 to +90 °C	16	16	16	16	Q ₁ Q ₁	HNBR
	AQQK	0-90 °C	16	16	16	16	Q ₁ Q ₁	FFKM
 O-ring seal, type D, balanced	DAQF	0-140 °C	25	25	25	25	AQ ₁	FXM
	DQQE	-20 to +120 °C	25	25	25	25	Q ₆ Q ₆	EPDM
	DQQV	-10 to +90 °C	25	25	25	25	Q ₆ Q ₆	FKM
	DQQX	-15 to +120 °C	25	25	25	25	Q ₆ Q ₆	HNBR
	DQQK	0-120 °C	25	25	25	25	Q ₆ Q ₆	FFKM

Recommended shaft seal for water-glycol mixture

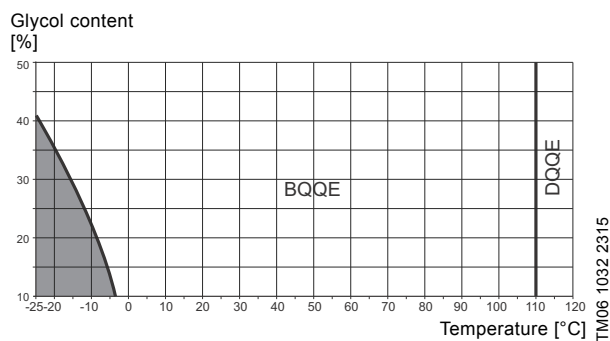

Fig. 37 Operating range of EPDM shaft seals

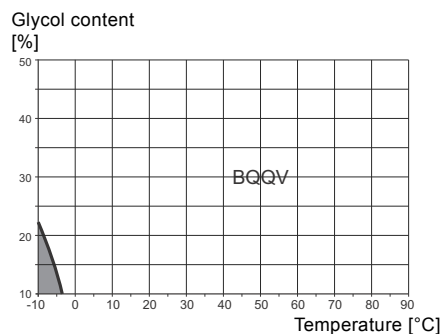

Fig. 38 Operating range of FKM shaft seals

Carbon-silicon carbide (xAQx), (xBQx), (xQBx)

Mechanical shaft seals with carbon-silicon carbide seal faces have a wide range of applications and are especially suitable if there is risk of dry running and/or if the temperature is high. These mechanical shaft seals are not suitable for liquids containing abrasive particles as the carbon parts will be worn. At temperatures below 0 °C, corrosion inhibitors containing abrasive particles are usually added to the pumped liquid, and these seals will thus not be suitable.

Note: The antimony impregnation (A) is not approved for potable water applications.

Silicon carbide-silicon carbide (xQQx)

Mechanical shaft seals with silicon carbide-silicon carbide seal faces also have a very wide range of applications. These seals are very resistant to abrasive particles and well suited at liquid temperatures up to 90 °C for Q₁ types, and up to 120 °C for Q₆ types. At higher temperatures, the reduced lubricating properties of the pumped liquid may cause noise problems and limit the life of the seal faces.

EPDM (xxxE)

Mechanical shaft seals with EPDM (xxxE) rubber are primarily suitable for water.

If the water contains oil or if chemicals or other liquids than water are pumped, you may have to replace the rubber parts of the mechanical shaft seal.

FKM (xxxV)

Mechanical shaft seals with FKM (xxxV) rubber have excellent resistance against oil and a number of chemicals.

Note: For detailed information about properties of all shaft seal components, see the data booklet "NB, NBG, NK, NKG, NBE, NBGE, NKE, NKGE - Custom-built pumps according to EN 733 and ISO 2858".

Operating range of stuffing boxes

Stuffing box type	Code for stuffing box	Code for packing material ¹	O-rings in pump	Temperature range ² [°C]	Max. p [bar]	Pumps	
						NB	NK
Internal barrier liquid	SNEA	B	EPDM	-30 to +140	16	-	•
	SNEB	T	EPDM	-30 to +140	16	-	•
	SNEC	B	FKM	-30 to +90	16	-	•
	SNED	T	FKM	-30 to +90	16	-	•
Without barrier liquid	SNOA	B	EPDM	-30 to +140	16	-	•
	SNOB	T	EPDM	-30 to +140	16	-	•
	SNOG	B	FKM	-30 to +90	16	-	•
	SNOD	T	FKM	-30 to +90	16	-	•
External barrier liquid	SNFA	B	EPDM	-30 to +140	16	-	•
	SNFB	T	EPDM	-30 to +140	16	-	•
	SNFC	B	FKM	-30 to +90	16	-	•
	SNFD	T	FKM	-30 to +90	16	-	•

¹ B: Buraflon®, PTFE-impregnated fibre packing rings

T: Thermoflon®, graphite-PTFE compound packing rings

² The temperature range applies to water and coolants.

Pressures in the pump

Maximum operating pressure

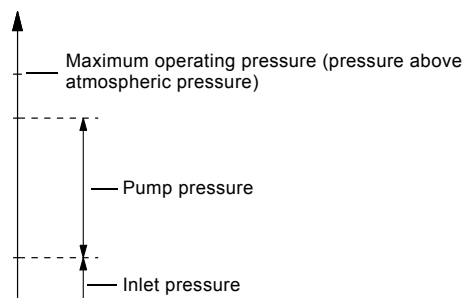

Fig. 39 Pressures in the pump

The inlet pressure + pump pressure must be lower than the maximum operating pressure (p) stated on the pump nameplate. The maximum operating pressure can be checked by closing the outlet valve briefly for maximum 30 seconds.

Minimum inlet pressure

The minimum inlet pressure must be according to the NPSH curve + correction for vapour pressure. We do, however, recommend that you calculate the inlet pressure in these cases:

- The liquid temperature is high.
- The flow rate is considerably higher than the pump's rated flow rate.
- The pump is operating in an open system with suction lift.
- The liquid is sucked through long pipes.
- The inlet conditions are poor.
- The operating pressure is low.

Maximum inlet pressure

The inlet pressure + pump pressure must be lower than the maximum operating pressure (p) stated on the pump nameplate. The maximum operating pressure can be checked by closing the outlet valve briefly for maximum 30 seconds.

TM04 0062 4907

Suction lift in open systems

Calculation of suction lift in open systems (water)

The suction lift "H" in metres head required during operation to avoid cavitation in the pump can be calculated by means of the following formula:

$$H = p_b \times 10.2 - NPSH - H_f - H_v$$

H	Suction lift
p_b	Barometric pressure in bar. The barometric pressure can be taken as equal to 1 bar. In closed systems, p _b indicates system pressure in bar.
NPSH	Net Positive Suction Head in metres head. The NPSH value can be read from the NPSH curve at the highest flow rate the pump will be delivering. The maximum flow rate must not exceed the maximum flow rate shown on the QH curve. The NPSH curve and QH curve for the individual pump can be found in Grundfos Product Center and in the relevant data booklet.
H_f	Friction loss in the inlet pipe in metres head at the highest flow rate the pump will be delivering.
H_v	Vapour pressure in metres head. See fig. 40.

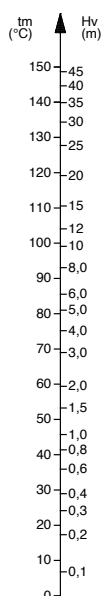

Fig. 40 Relation between liquid temperature and vapour pressure

TM00 3037 0798

Positive H value

Example:

- Liquid temperature: 20 °C
- Pump type: NK 50-200/219, 2-pole, 50 Hz
- Flow rate: 70 m³/h
- p_b: 1 bar
- NPSH: 2.8 m head
- H_f: 3.0 m head
- H_v: 0.24 m head

$$H = p_b \times 10.2 - NPSH - H_f - H_v \text{ [m head]}$$

$$H = 1 \times 10.2 - 2.8 - 3.0 - 0.24 = 4.16 \text{ m head}$$

If the calculated value of H is positive, the pump can operate with a maximum suction lift of H metres.

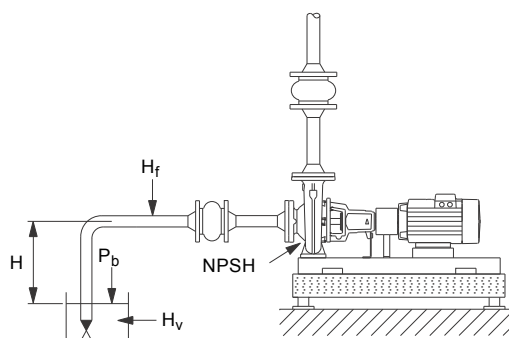

Fig. 41 Suction lift with positive H

TM05 6778 5112

Negative H value

Example:

- Liquid temperature: 90 °C
- Pump type: NK 50-200/219, 2-pole, 50 Hz
- Flow rate: 70 m³/h
- p_b: 1 bar
- NPSH: 2.8 m head
- H_f: 3.0 m head
- H_v: 7.2 m head

$$H = p_b \times 10.2 - NPSH - H_f - H_v \text{ [m head]}$$

$$H = 1 \times 10.2 - 2.8 - 3.0 - 7.2 = -2.8 \text{ m head}$$

If the calculated value of H is negative, a minimum suction head of H metres is required. The calculated H must be present during operation.

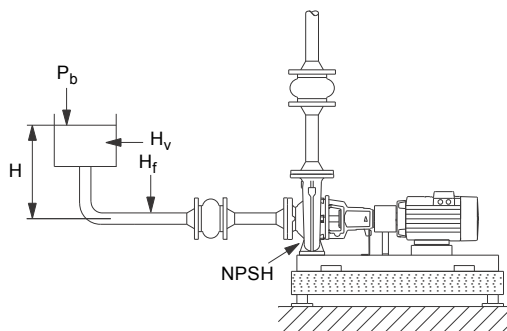

Fig. 42 Suction lift with negative H

TM05 6779 5112

8. Mechanical installation

Foundation and grouting

Foundation

We recommend that you install the pump on a plane and rigid concrete foundation which is heavy enough to provide permanent support for the entire pump. The foundation must be capable of absorbing any vibration, normal strain or shock. As a rule of thumb, the weight of the concrete foundation must be 1.5 times the weight of the pump.

The foundation must be 100 mm larger than the base frame on all four sides. See fig. 43.

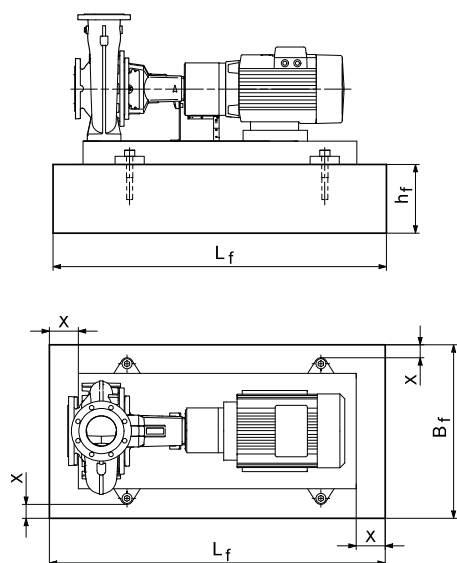

Fig. 43 Foundation, X is equal to minimum 100 mm

The minimum height of the foundation (h_f) can then be calculated:

$$h_f = \frac{m_{\text{pump}} \times 1.5}{L_f \times B_f \times \delta_{\text{concrete}}}$$

The density (δ) of concrete is usually taken as 2200 kg/m³.

Place the pump on the foundation, and fasten it. The base frame must be supported under its entire area. See fig. 44.

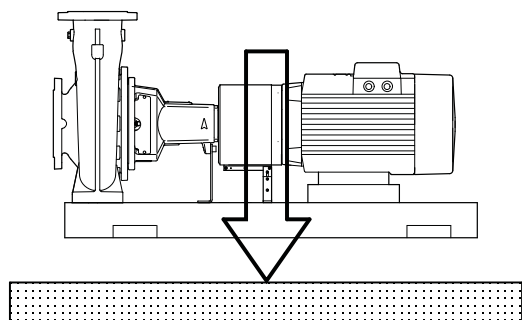

Fig. 44 Correct foundation

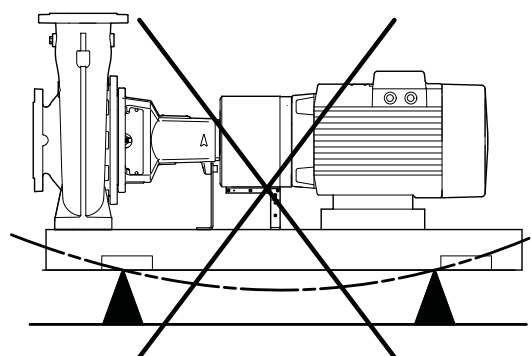

Fig. 45 Incorrect foundation

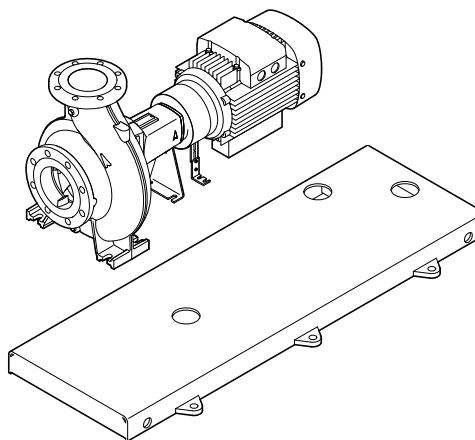

Fig. 46 Base frame prepared for grouting

TM03 3771 1206

TM03 4324 1206

TM03 4587 2206

TM03 3950 1206

Grouting

Grouting compensates for uneven foundation, distributes the weight of the unit, dampens vibrations and prevents shifting.

All NK pumps can be delivered with base frames prepared for grouting as an option. NB pumps with base frames are always prepared for grouting.

For 2-pole NK and NB pumps with motors as from 55 kW, grouting of the base frame is mandatory in order to prevent vibration energy from the rotating motor and the liquid flow.

Use an approved, non-shrinking grout. If in doubt, contact your grout supplier.

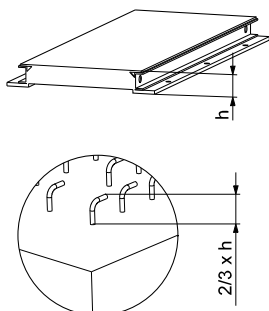

TM04 0490 0708

Fig. 47 Reinforcing steel bars embedded in foundation

Use reinforcing steel bars embedded in the foundation to ensure proper grouting.

Build a strong formwork around the foundation.

Soak the top of the concrete foundation thoroughly, and remove surface water.

Fill the formwork with grout up to the base frame top level. See fig. 48. Allow the grout to dry thoroughly before attaching pipes to the pump. 24 hours is sufficient time with approved grouting procedure.

When the grout has thoroughly hardened, check the anchor bolt nuts and tighten, if necessary.

Approximately two weeks after the grout has been poured, or when the grout has thoroughly dried, apply an oil-based paint to the exposed edges of the grout to prevent air and moisture from getting into contact with the grout.

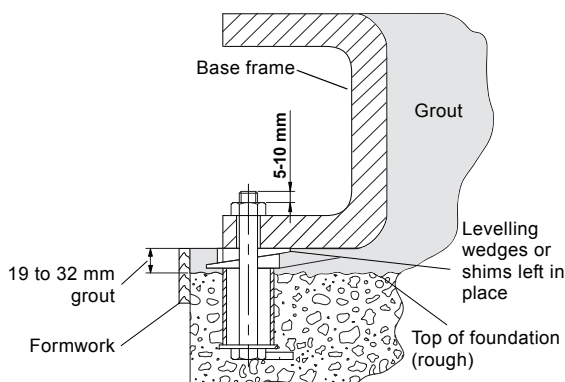

TM03 2946 4707

Fig. 48 Sectional view of foundation with anchor bolt, grouting and base frame

Pipes

Pipes

When installing the pipes, make sure that the pump housing is not stressed by the pipes.

The inlet and outlet pipes must be of an adequate size, taking the pump inlet pressure into account.

Install the pipes so that air locks are avoided, especially on the inlet side of the pump. See fig. 49.

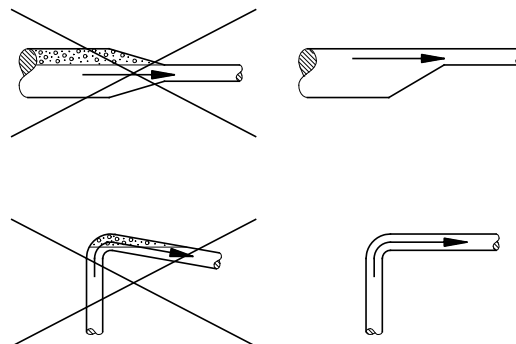

TM00 2263 3393

Fig. 49 Pipelines

Fit isolating valves on either side of the pump to avoid having to drain the system if the pump needs to be cleaned or repaired.

Make sure that the pipes are adequately supported as close to the pump as possible, both on the inlet and the outlet side. The counterflanges must lie true against the pump flanges without being stressed as this would cause damage to the pump.

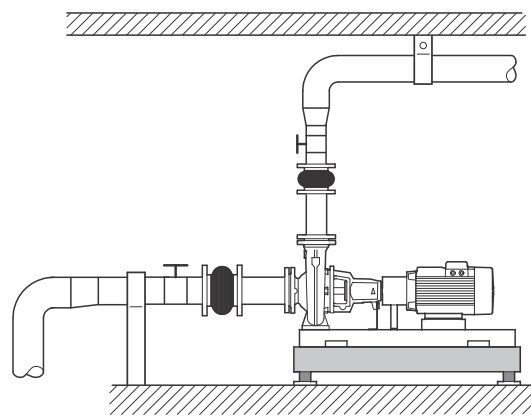

TM05 3488 1412

Fig. 50 Pipeline mounting

Direct mounting in pipes

NB pumps of mounting design A are suitable for direct mounting in supported pipes.

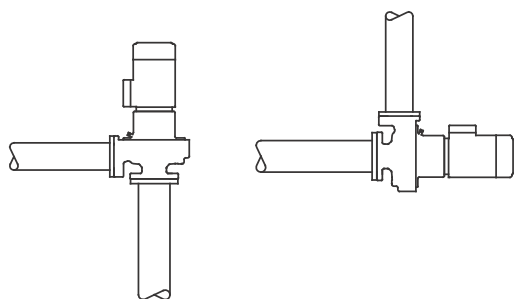

TM05 3337 1212

Fig. 51 Direct mounting in pipes

This type of installation does not allow the use of expansion joints.

Note: To ensure quiet operation, the pipes must be suspended from suitable pipe hangers.

Condensation cover

When installing the pumps outdoors, provide the motor with a suitable cover to protect the pump and motor against the direct effects of the elements.

When mounting the condensation cover on top of the motor, make sure to leave enough space for the air to cool the motor.

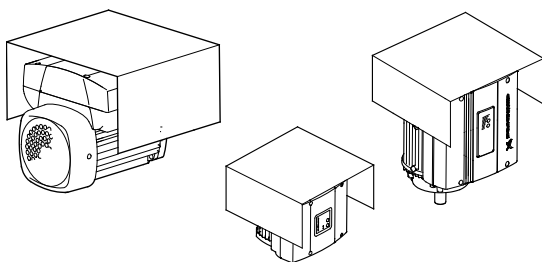

TM02 8514 0304 - TM00 8622 0101

Fig. 52 Motors with condensation cover

Elimination of noise and vibrations

In order to achieve optimum operation and minimum noise and vibration, consider vibration dampening of the pump. Generally, always consider this for pumps with motors above 11 kW. Smaller motor sizes, however, may also cause undesirable noise and vibration.

Noise and vibration are generated by the revolutions of the motor and pump and by the flow in pipes and fittings. The effect on the environment is subjective and depends on correct installation and the state of the remaining system.

Elimination of noise and vibrations is best achieved by means of vibration dampers and expansion joints. See fig. 50.

Vibration dampers

To prevent the transmission of vibrations to buildings, we recommend that you isolate the pump foundation from building parts by means of vibration dampers.

The selection of the right vibration damper requires the following data:

- forces transmitted through the damper
- motor speed considering speed control, if any
- required dampening in %; the suggested value is 70 %.

The selection of vibration damper differs from installation to installation. In certain cases, a wrong damper may increase the vibration level. Vibration dampers must therefore be sized by the supplier of the vibration dampers.

If you install the pump on a foundation with vibration dampers, always fit expansion joints on the pump flanges. This is important to prevent the pump from "hanging" in the flanges.

Expansion joints

Install expansion joints for these purposes:

- to absorb expansions or contractions in the pipes caused by changing liquid temperature
- to reduce mechanical strains in connection with pressure surges in the pipes
- to isolate mechanical structure-borne noise in the pipes; this applies only to rubber bellows expansion joints.

Note: Do not install expansion joints to make up for inaccuracies in the pipes, such as centre displacement or misalignment of flanges.

Fit the expansion joints at a minimum distance of 1 to 1 1/2 pipe diameters (DN) away from the pump on the inlet and the outlet side. This prevents turbulence in the joints, thus ensuring optimum suction conditions and minimum pressure loss on the outlet side. At flow velocities greater than 5 m/s, we recommend that you fit larger expansion joints matching the pipes.

The illustration below shows examples of rubber bellows expansion joints with or without limiting rods.



TM02 4979 1902

TM02 4981 1902

Fig. 53 Rubber bellows expansion joints with and without limiting rods

Expansion joints with limiting rods can be used to reduce the effects of the expansion or contraction forces on the pipes. We always recommend expansion joints with limiting rods for flanges larger than DN 100. Anchor the pipes in such a way that they do not stress the expansion joints and the pump. Follow the supplier's instructions and pass them on to advisers or pipe installers.

The illustration below shows an example of a metal bellows expansion joint with limiting rods.

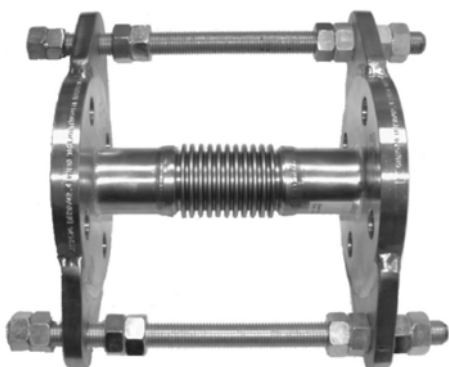

TM02 4980 1902

Fig. 54 Metal bellows expansion joint with limiting rods

Due to the risk of rupture of the rubber bellows, metal bellows expansion joints may be preferred at temperatures above 100 °C combined with high pressure.

Alignment

Alignment applies only to NK, NKE pumps.

In a complete pump unit assembled and supplied from factory, the coupling halves have been accurately aligned. Alignment is made by inserting shims under the pump and motor mounting surfaces as required.

The pump-motor alignment may be affected during transport. Always check alignment after the pump has been installed.

If misalignment has occurred due to radial or angular shifting, realign by inserting or removing shims under the feet of the pump or the motor.

Take care to align carefully, as this increases the lives of the coupling, bearings and shaft seal considerably.

Note: Check the final alignment when the pump has obtained its operating temperature under normal operating conditions.

9. Speed-controlled pumps

NB and NK pumps are available with MGE motors with integrated speed control. These pumps are also called E-pumps and the pump designation is NBE and NKE.

E-pumps are suitable for applications where the pressure, temperature, flow rate or another parameter is to be controlled on the basis of signals from a sensor at some point in the system.

There are two variants of E-pumps for NB and NK products:

- NBE, NKE pumps without sensors from the factory



TM06 7263 3316
TM07 2889 4318

- NBE, NKE Series 2000 pumps with factory-fitted differential-pressure sensors

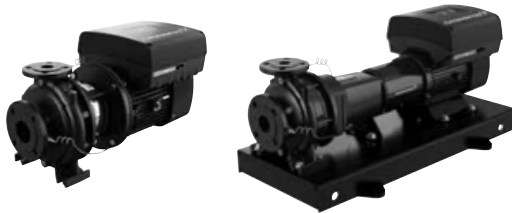

TM07 2518 3918
TM07 2519 3918

E-pump type	2-pole	4-pole	6-pole	8-pole
NBE, NKE	1.1 - 22 kW	0.55 - 18.5 kW	-	-
NBE, NKE Series 2000	1.1 - 11 kW	0.55 - 7.5 kW	-	-

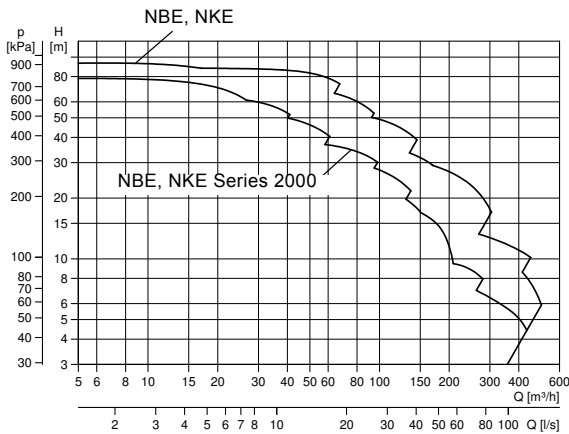

TM07 3013 4518

Fig. 55 E-pumps performance range

Pumps larger than 22 kW, 2-pole and 18.5 kW, 4-pole, and 6- and 8-pole can be connected to an external frequency converter.

The integrated speed control enables the pump to operate at any duty point between 25 % and 100 % speed. The performance adapts to current conditions and keeps the energy consumption at a minimum.

The 100 % curve corresponds to the curve of a pump with a mains-operated motor.

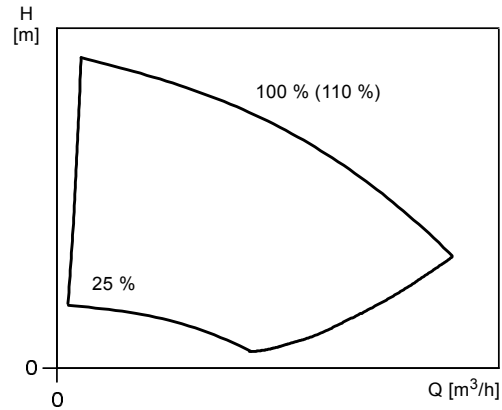

TM01 4916 1099

Fig. 56 Duty range of E-pumps

As a part of the duty range as shown in fig. 57, the pumps with MGE motor can operate at speeds up to 110 %.

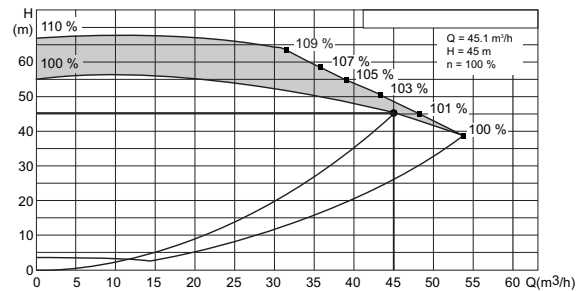

TM05 9472 3913

Fig. 57 Example on extended performance range up to 110 % as a part of the operation range

The extended range is achieved by means of optimised software which utilises the MGE motor to its maximum in an optimum way. As a result, the E-pump is able to deliver higher head and flow rate with the same motor size. The curve sheets in this data booklet only show the nominal 100 % Q-H curve of pumps with standard motors. You may find information on the extended performance range in Grundfos Product Center.

Why select an E-pump

The main reasons for choosing the Grundfos E-motor instead of a conventional standard motor and separate frequency converter are the following:

1. Unique product
 - The motor and frequency converter are perfectly matched. The customer will not experience the same problems which may occur when using a standard motor with separate frequency converter, such as noise due to switch frequency.
 - Predefined intelligent control modes, such as constant pressure and constant level. These predefined control modes make it easy to fit the pump into any application.
2. Full application adaptation
 - Functionality is matched to the specific pump application.
 - Grundfos makes a customised configuration file to suit the customer's requirements.
 - Full adaptation to any control management system by means of various interfaces.
3. Simple and easy installation
 - Reduced installation and wiring costs compared to standard frequency converters.
 - No further programming required. An E-motor is a plug-and-pump product.
 - On-site customisation of the software configuration file to adapt to changed operating parameters.
 - Control, monitor, install, commission, and email reports all from your smart device via the Grundfos GO technology.
4. One supplier
 - Complete product is supplied by one sole supplier. This gives the customer security as only one supplier needs to be contacted in case of problems or complaints.

For more information on the E-pumps for NBE and NKE and their detailed functionalities, see the data booklet "NB, NBG, NK, NKG, NBE, NBGE, NKE, NKGE - Custom-built pumps according to EN 733 and ISO 2858".

Maximum speed of the impeller

The table below shows the relationship between pump speed and impeller material and size.

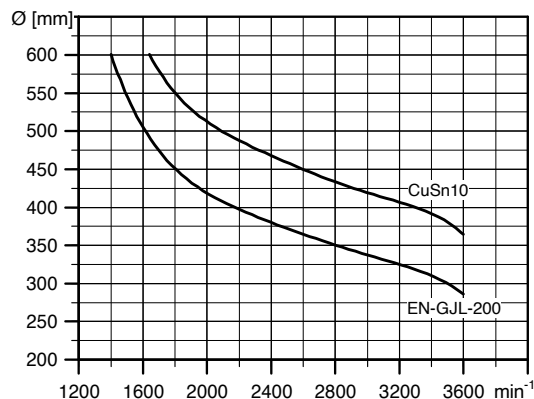

TM03 4109 1806

Fig. 58 Maximum permissible speed

For stainless steel impellers (1.4408/1.4517) the limit is 3600 min⁻¹ regardless of impeller size.

Affinity equations

Normally, NBE and NKE pumps are used in applications characterised by a variable flow. Consequently, it is not possible to select a pump that is constantly operating at its optimum efficiency.

To achieve optimum operating economy, select the pump on the basis of the following criteria:

- The maximum duty point required must be as close as possible to the QH curve of the pump.
- The flow rate at the duty point required must be close to the optimum efficiency (eta) for most operating hours.

Between the minimum and maximum performance curve, NBE and NKE pumps have an infinite number of performance curves each representing a specific speed. It may therefore not be possible to select a duty point close to the maximum curve.

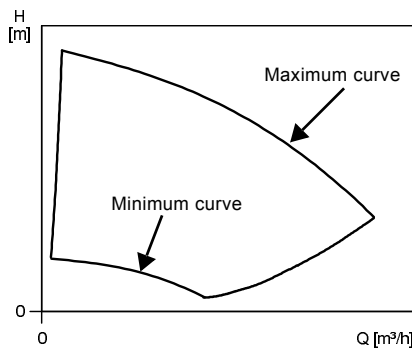

Fig. 59 Minimum and maximum performance curves

In situations where it is not possible to select a duty point close to the maximum curve, use the affinity equations below. The head (H), the flow rate (Q) and the input power (P) are the appropriate variables you need to be able to calculate the motor speed (n).

Note: The approximated formulas apply on condition that the system characteristic remains unchanged for n_n and n_x and that it is based on the formula $H = k \times Q^2$, where k is a constant.

The power equation implies that the pump efficiency is unchanged at the two speeds. In practice, this is not quite correct.

Finally, it is worth noting that the efficiencies of the frequency converter and the motor must be taken into account if a precise calculation of the power saving resulting from a reduction of the pump speed is wanted.

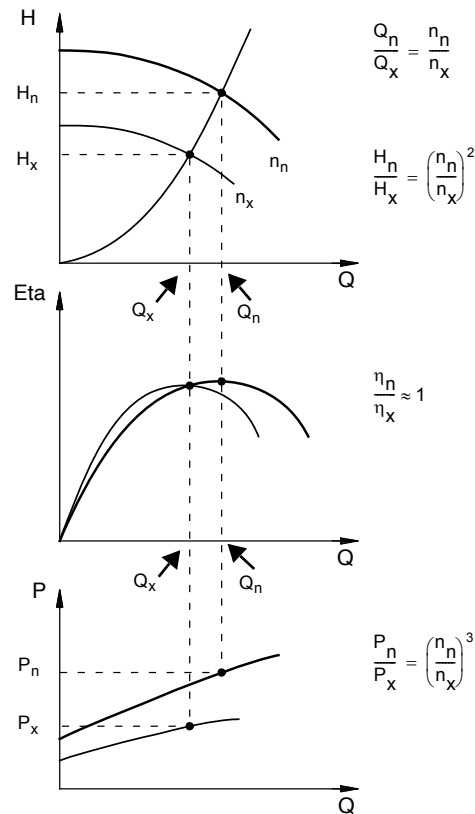

Fig. 60 Affinity equations

Legend

H_n	Rated head in m
H_x	Actual head in m
Q_n	Rated flow rate in m ³ /h
Q_x	Actual flow rate in m ³ /h
P_n	Rated input power in kW
P_x	Actual input power in kW
n_n	Rated motor speed in min ⁻¹
n_x	Actual motor speed in min ⁻¹
η_n	Rated efficiency in %
η_x	Actual efficiency in %

Grundfos Product Center

Grundfos Product Center are selection programs offered by Grundfos.

The two programs make it possible to calculate the specific duty point and energy consumption of an NBE or NKE pump.

When you enter the pump data, Grundfos Product Center can calculate the exact duty point and energy consumption. For further information, see [23. Grundfos Product Center](#) on page 220.

TM01 4916 4803

TM00 8720 3496

Communication with the E-solution

	E-solution	
	MGE	CUE
Operating panel on unit	x	x
Grundfos GO control	x	-
Central building management system	x	x

Operating panel

Operating panel for 1.1 - 11 kW, 2-pole and 0.55 - 7.5 kW 4-pole motors

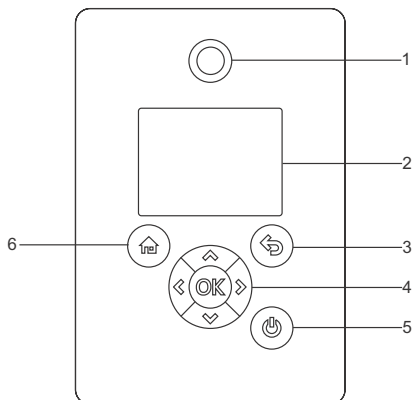

TM05 4849 1013

Fig. 61 Advanced control panel

Pos.	Symbol	Description
1		Grundfos Eye The indicator light shows the operating status of the pump.
2	-	Graphical colour display.
3		Press the button to go one step back.
4		Press the button to navigate between main menus, displays and digits. When you change the menu, the display always shows the top display of the new menu.
		Press the buttons to navigate between submenus or change value settings. Note: If you have disabled the possibility to make settings with the "Enable/disable settings" function, then you can enable it again temporarily by pressing these buttons simultaneously for at least 5 seconds.
4		Press the button to save changed values, reset alarms and expand the value field. The button enables radio communication with Grundfos GO and other products of the same type. When you try to establish radio communication between the pump and Grundfos GO or another pump, the green indicator light in Grundfos Eye flashes. A note also appears in the pump display stating that a wireless device wants to connect to the pump. Press on the pump control panel to allow radio communication with Grundfos GO and other products of the same type.
		Press the button to make the pump ready for operation or to start and stop the pump. Start: If you press the button when the pump is stopped, the pump will only start if no other functions with higher priority have been enabled. Stop: If you press the button when the pump is running, the pump always stops. When you stop the pump via this button, the icon appears in the bottom of the display.
6		Press the button to go to the "Home" menu.

Operating panel for 15-22 kW, 2-pole and 11 - 18.5 kW, 4-pole motors

The operator can change the setpoint settings manually on the operating panel on the terminal box of the speed-controlled pump.

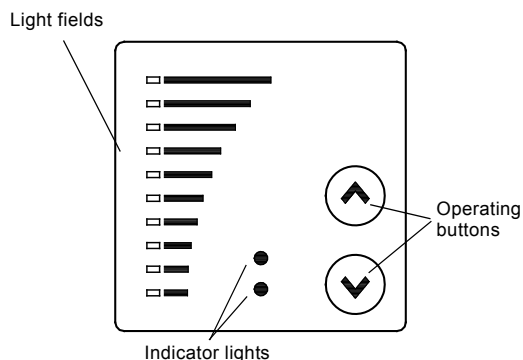

TM00 7600 0404

Fig. 62 Operating panel for 15-22 kW, 2-pole and 11 - 18.5 kW, 4-pole motors

Remote control

Grundfos GO

The pump is designed for wireless radio or infrared communication with the Grundfos GO.

Grundfos GO enables setting of functions and gives access to status overviews, technical product information and actual operating parameters.

Grundfos GO offers the following mobile interfaces, MI. See fig. 63.

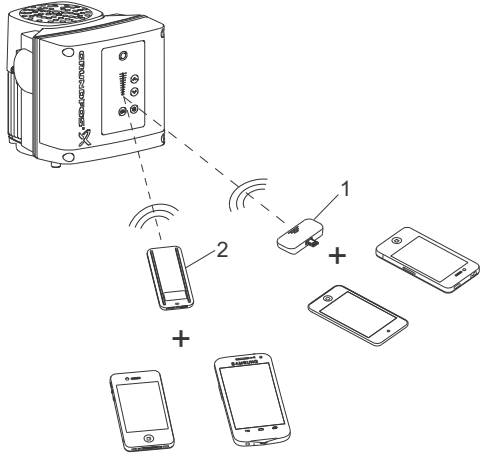

TM06 6256 0916



Fig. 63 Grundfos GO communicating with the pump via radio or infrared connection, IR

Pos.	Description
1	Grundfos MI 204: Add-on module enabling radio or infrared communication. You can use MI 204 in conjunction with an Apple iPhone or iPod with Lightning connector, for example fifth generation or later iPhone or iPod. MI 204 is also available together with an Apple iPod touch and a cover.
2	Grundfos MI 301: Separate module enabling radio or infrared communication. You can use the module in conjunction with an Android or iOS-based smart device with Bluetooth connection.

Communication

When Grundfos GO initiates communication with the pump, the indicator light in the middle of Grundfos Eye flashes green.

Radio communication

Radio communication can take place at distances up to 30 metres. The first time Grundfos GO communicates with the pump, you must enable communication by pressing  or  on the pump control panel. Later when communication takes place, the pump is recognised by Grundfos GO, and you can select the pump from the "List" menu.

Infrared communication

When communicating via infrared light, Grundfos GO must be pointed at the pump control panel.

Communication with E-pumps

Communication with E-pumps is possible via a central building management system, remote control (Grundfos GO) or operating panel.

Central building management system

The operator can communicate with an E-pump at a distance. Communication can take place via a central building management system allowing the operator to monitor and change control modes and setpoint settings.

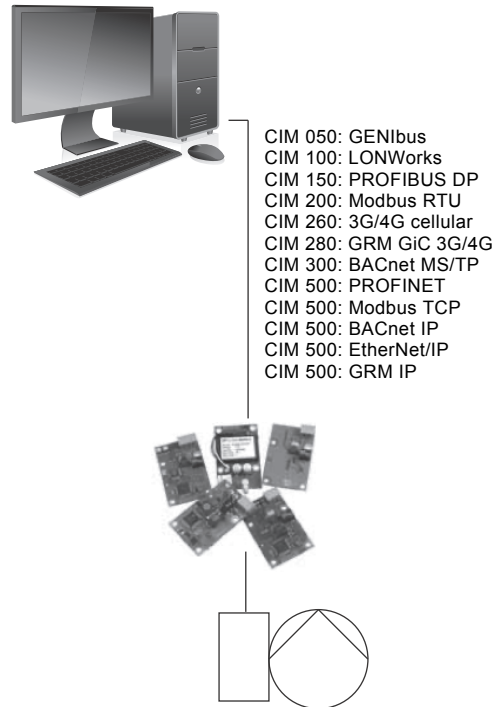

- CIM 050: GENIbus
- CIM 100: LONWorks
- CIM 150: PROFIBUS DP
- CIM 200: Modbus RTU
- CIM 260: 3G/4G cellular
- CIM 280: GRM GiC 3G/4G
- CIM 300: BACnet MS/TP
- CIM 500: PROFINET
- CIM 500: Modbus TCP
- CIM 500: BACnet IP
- CIM 500: EtherNet/IP
- CIM 500: GRM IP

All E-pump sizes can be equipped with a CIM module

TM06 7405 3316

Fig. 64 Structure of a central building management system

10. Pumps connected in parallel

Control of pumps connected in parallel

In some applications, parallel pump operation is required for one or more of the following reasons:

- One pump cannot achieve the required performance or flow rate.
- Standby capacity is required to ensure reliability of supply.
- Overall efficiency needs to be improved in case of big variations in the flow rate demand.

NB, NBE, NK, NKE pumps connected in parallel can be controlled by Control MPC.



TM03 0413 5004

Fig. 65 Control MPC

Pumps connected to Control MPC

NB, NBE, NK, NKE pumps can be connected directly to Grundfos Control MPC.

Control MPC incorporates, among others, a CU 352 controller that can control up to six pumps.

By means of an external sensor, Control MPC can ensure optimum adaptation of the performance to the demand by closed-loop control of these parameters:

- proportional differential pressure
- constant differential pressure
- differential pressure, remote
- flow rate
- temperature.

CU 352 incorporates features such as those below:

Startup wizard

Correct installation and commissioning is a prerequisite for attaining optimum performance of the system and trouble-free operation year in and year out. During commissioning of the system, a startup wizard is shown on the display of the CU 352. The wizard guides the operator through the various steps via a series of dialogue boxes to ensure that all settings are done in the correct sequence.

Application-optimised software

CU 352 incorporates application-optimised software which helps you set your system to the application in question.

Furthermore, you can easily navigate through the menus of the controller. You do not need any training to be able to set and monitor the system.

Ethernet connection

CU 352 incorporates an Ethernet connection which makes it possible to get full and unlimited access to the setting and monitoring of the system via a remote PC.

Service port, GENI TTL

The service port of the CU 352 enables easy access to updating software and data logging in service situations.

External communication

Control MPC enables communication with other fieldbus protocols. In order to communicate with other fieldbus protocols, a GENIbus module and a gateway is needed.

Control MPC can communicate with LON, PROFIBUS, Modbus or BACnet via Grundfos CIU.

Note: For further information about Control MPC, see the "Control MPC" data booklet. The data booklet is available in Grundfos Product Center on www.grundfos.com. For further information on Grundfos Product Center, see [23. Grundfos Product Center](#) on page 220.

11. Selection of product

Key application data sheet

Our "Key application data sheet" can be used to gather the information typically needed in order to make the most suitable pump configuration.

Consider the following aspects when configuring a pump:

- the pumped liquid
- viscosity and density
- solids in the liquid
- operating temperatures and pressures
- customer-specific requirements.

These and other operating conditions listed in the data sheet are important for choosing the right pump material, shaft seal and shaft seal arrangement.

The data sheet can be seen as a check list and can be filled in by the customer alone or together with a Grundfos representative.

We recommend that you always fill in this data sheet as it saves a lot of time for the customer and for Grundfos.

The "Key application data sheet" can be found in Grundfos Product Center.

Search result

1

Literature NB

Input product number or a whole or partial product name

Documents

Literature language: English

	Title	Document Number	Literature language	Literature category	Product type	Date added	Version
▶	Brochures						
▶	Installation & operating instructions						
▶	Service						
▼	Data booklets						
<input type="checkbox"/>	Hydro Diesel-NB/NK (Fire system)	96635218	English	Data booklets	-	2/14/2012	
<input type="checkbox"/>	Hydro Syntax-NB/NK (Fire system)	96635217	English	Data booklets	-	10/14/2011	
<input type="checkbox"/>	Hydro UNI-NB/NK (Fire system)	96635219	English	Data booklets	-	8/14/2012	
<input type="checkbox"/>	NB, NBE, NK, NKE	96653947	English	Data booklets	-	11/6/2015	Latest <input type="button" value="v"/>
<input type="checkbox"/>	NB, NBD, NK, NKG, NBE, NBDGE, NKE, NKGGE (Custom-built pumps)	97572305	English	Data booklets	-	2/17/2015	Latest <input type="button" value="v"/>
<input checked="" type="checkbox"/>	NB, NBD, NK, NKG, NBE, NBDGE, NKE, NKGGE (Key application data) (Data Sheet)	96150787	English	Data booklets	-	3/1/2012	

2

TM06 5000 3615

Fig. 66 How to find the "Key application data sheet" in Grundfos Product Center

Pump size

Select the pump size on the basis of these conditions:

- required flow rate and pressure at the draw-off point
- pressure loss as a result of height differences
- friction loss in the pipes.
It may be necessary to account for pressure loss in connection with long pipes, bends or valves, etc.
- optimum efficiency at the estimated duty point.

Efficiency

If you expect the pump to always operate at the same duty point, select a pump which operates at a duty point corresponding to the optimum efficiency of the pump.

In case of controlled operation or varying consumption, select a pump whose optimum efficiency falls within the duty range covering the greater part of the duty time.

Material

Select the material variant on the basis of the liquid to be pumped. See section [12. Pumped liquids](#).

Motor size

Select the motor size on the basis of the power required to achieve the duty point of the chosen pump. This information can be found in the power chart below each performance chart. See performance curves on pages [77](#) to [131](#). When a pump is fitted with a stuffing box, select the motor size according to ISO 5199.

Find the power curve corresponding to the required QH-value or interpolate between curves.

To select the motor size, read the value of the P2 curve at the duty point and add a 5 % safety margin.

If the motor size must be selected according to ISO 5199, see the table below.

Safety margins according to ISO 5199

Required pump power up to [kW]	Motor power P2 [kW]
0.18	0.25
0.27	0.37
0.40	0.55
0.55	0.75
0.81	1.1
1.1	1.5
1.7	2.2
2.3	3
3.2	4
4.3	5.5
6.1	7.5
9.1	11
12.8	15
15.9	18.5
19	22
26	30
32.5	37
40	45
49	55
68	75
81	90
100	110
120	132
145	160
181	200
227	250
286	315
322	355
364	400

12. Pumped liquids

General recommendations

We recommend NB and NK pumps for thin, clean and non-explosive liquids not containing solid particles or fibres.

Liquids with temperatures ranging from -25 to +140 °C are covered in this data booklet.

For liquids ranging from -40 to +220 °C, see the data booklet "NB, NBG, NK, NKG, NBE, NBGE, NKE, NKGE - Custom-built pumps according to EN 733 and ISO 2858", or contact Grundfos.

Water in heating and ventilating systems often contains additives to prevent negative effects, such as system corrosion or calcareous deposits. In these cases, we recommend special shaft seals to avoid crystallisation/precipitation between the seal faces.

For heating systems, the water quality must meet VDI2035.

"Liquids" in Grundfos Product Center

The Grundfos product selection tool Grundfos Product Center contains a "Liquids" module which is based on the type and properties of the pumped liquid and which gives recommendations with regard to materials for the wetted parts of the pump, i.e. recommend suitable and durable materials for pump housing, impeller, shaft, mechanical shaft seal and O-rings.

The "Liquids" module covers more than 170 widely used liquids.

Please note that other factors also affect the chemical resistance of the pump materials:

- solids
- contaminants
- pressure
- cleaning procedures.

These factors are NOT considered in this tool, and the suitability of the pump material configuration can only be proved through a test.

When selecting the shaft seal and the shaft seal arrangement, we recommend that you consult the data booklet "NB, NBG, NK, NKG, NBE, NBGE, NKE, NKGE - Custom-built pumps" for further information.

For pumped liquids with a density and/or viscosity higher than those of water, use motors with correspondingly higher outputs.

Type	Pump [mm]							Supporting feet [mm]										Shaft [mm]					Weight [kg]	
	DNs	DNt	a	f	h1	h2	M	b	m1	m2	n1	n2	n3	w	S1	S2	c	d5	l	X	t	n	Cl ¹	SS ²
NK 150-200	200	150	160	470	280	400	1/2"	100	200	150	550	450	110	340	M20	M12	26	32	80	140	35	10	210	205
NK 150-250	200	150	160	530	280	375	1/2"	100	200	150	500	400	110	370	M20	M12	20	42	110	140	45	12	196	206
NK 150.315.2	200	150	160	530	280	400	1/2"	100	200	150	550	450	110	370	M20	M12	20	42	110	140	45	12	252	255
NK 150-315	200	150	160	530	280	400	1/2"	100	200	150	550	450	110	370	M20	M12	20	42	110	140	45	12	250	253
NK 150-400	200	150	160	530	315	450	1/2"	100	200	150	550	450	110	370	M20	M12	19	42	110	140	45	12	286	291
NK 150-400*	200	150	160	670	315	450	1/2"	100	200	150	550	450	140	500	M20	M16	19	48	110	180	51.5	14	366	370
NK 150-500	200	150	180	670	400	500	1/2"	125	200	150	625	500	140	500	M20	M16	29	60	110	180	64	18	522	534

¹ Cl: Cast iron version

² SS: Stainless steel version

* Oversize shaft

X is the minimum pull-back length of the bearing bracket required for service of impeller and shaft seal.

Oversize pumps

EN 733 describes only the standard types.

The NK range includes bigger models, oversize pumps, for higher flow rates and heads.

As oversize pumps are not according to the standard, dimensions of Grundfos NK oversize pumps may differ from the dimensions of similar pumps from other suppliers.

NK, tangential outlet

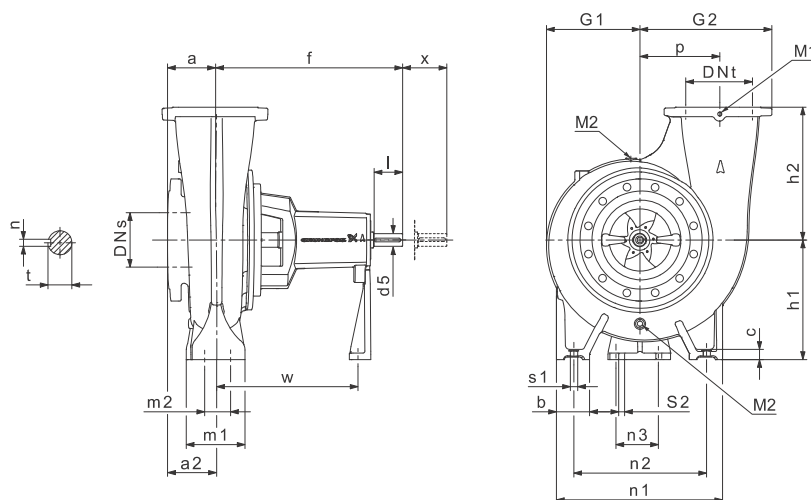

TM04 3857 1718

M1 / M2 Drain plug or priming plug

Type	Pump [mm]										Supporting feet [mm]										Shaft [mm]					Weight [kg]		
	DNs	DNt	a	a2	f	h1	h2	M1	M2	G1	G2	p	b	m1	m2	n1	n2	n3	w	S1	S2	c	d5	l	X	t	n	Cl ¹
NK 200-400	250	200	170	180	698	400	400	3/8"	1/2"	331	485	315	125	200	150	625	500	140	519	M20	M16	33	48	110	180	51.5	14	428
NK 200-450	250	200	150	154	691	400	450	3/8"	1/2"	355	525	355	125	200	150	625	500	140	519	M20	M16	33	48	110	180	51.5	14	443
NK 250-350	300	250	175	190	739	450	400	3/8"	1/2"	379	523	320	125	200	150	625	500	140	559	M20	M16	33	48	110	180	51.5	14	528
NK 250-400	300	250	160	173	714	450	500	3/8"	1/2"	350	498	295	125	200	150	625	500	140	532	M20	M16	33	48	110	180	51.5	14	479
NK 250-450	300	250	165	173	704	450	500	3/8"	1/2"	374	563	360	125	200	150	625	500	140	515	M20	M16	33	60	110	180	64	18	557
NK 250-500	300	250	165	170	709	450	500	3/8"	1/2"	441	598	395	125	200	150	725	600	140	528	M20	M16	33	60	110	180	64	18	670

¹ Cl: Cast iron version

X is the minimum pull-back length of the bearing bracket required for service of impeller and shaft seal.

14. Pump flange dimensions

Fixed pump flanges, EN 1092-2

EN 1092-2 is the standard used for cast iron pump flanges. The flange dimensions are stated in mm.

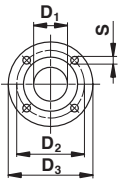

		EN 1092-2										
		Nominal diameter										
		DN 32	DN 40	DN 50	DN 65	DN 80	DN 100	DN 125	DN 150	DN 200	DN 250	DN 300
PN 10	D ₁	32	40	50	65	80	100	125	150	200	250	300
	D ₂	100	110	125	145	160	180	210	240	295	350	400
	D ₃	140	150	165	185	200	220	250	285	340	395	445
	S	4 x Ø19	4 x Ø19	4 x Ø19	4 x Ø19	8 x Ø19	8 x Ø19	8 x Ø19	8 x Ø23	8 x Ø23	12 x Ø23	12 x Ø23
PN 16	D ₂	100	110	125	145	160	180	210	240	295	355	410
	D ₃	140	150	165	185	200	220	250	285	340	405	460
	S	4 x Ø19	4 x Ø19	4 x Ø19	4 x Ø19	8 x Ø19	8 x Ø19	8 x Ø19	8 x Ø23	12 x Ø23	12 x Ø28	12 x Ø28

Fixed pump flanges, AS2129 table E

AS2129 table E is the Australian standard for cast iron pump flanges. The flanges are available on request. The flange dimensions are stated in mm.

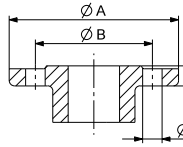

		Nominal flange size									
		32	40	50	65	80	100	125	150	200	
	Flange diameter	A	140	150	165	185	200	220	250	285	340
	Pitch circle diameter	B	87	98	114	127	146	178	210	235	292
	Flange thickness	C	18	18	20	20	22	24	26	26	30
	Hole diameter	D	14	14	18	18	18	18	18	22	22
	Number of holes	N	4	4	4	4	4	8	8	8	8

Fixed pump flanges, EN 1092-1

EN 1092-1 is the standard used for stainless steel pump flanges. The flange dimensions are stated in mm.

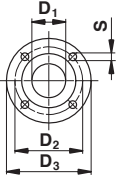

		EN 1092-1									
		Nominal diameter									
		DN 32	DN 40	DN 50	DN 65	DN 80	DN 100	DN 125	DN 150	DN 200	
PN 10	D ₁	32	40	50	65	80	100	125	150	200	
	D ₂	100	110	125	145	160	180	210	240	295	
	D ₃	140	150	165	185	200	220	250	285	340	
	S	4 x Ø19	4 x Ø19	4 x Ø19	4 x Ø19	8 x Ø19	8 x Ø19	8 x Ø19	8 x Ø23	8 x Ø23	
PN 16	D ₂	100	110	125	145	160	180	210	240	295	
	D ₃	140	150	165	185	200	220	250	285	340	
	S	4 x Ø19	4 x Ø19	4 x Ø19	4 x Ø19	8 x Ø19	8 x Ø19	8 x Ø19	8 x Ø23	12 x Ø23	
PN 25	D ₂	100	110	125	145	160	190	220	250	310	
	D ₃	140	150	165	185	200	235	270	300	360	
	S	4 x Ø19	4 x Ø19	4 x Ø19	8 x Ø19	8 x Ø19	8 x Ø23	8 x Ø28	8 x Ø28	12 x Ø28	
PN 40	D ₂	100	110	125	145	160	190	220	250	320	
	D ₃	140	150	165	185	200	235	270	300	375	
	S	4 x Ø19	4 x Ø19	4 x Ø19	8 x Ø19	8 x Ø19	8 x Ø23	8 x Ø28	8 x Ø28	12 x Ø31	

Loose pump flanges, EN 1092-1

EN 1092-1 is the standard used for stainless steel pump flanges. The flange dimensions are stated in mm.

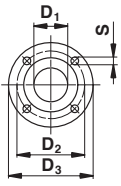

TM02 7720 3803

EN 1092-1

	Nominal diameter									
	DN 32	DN 40	DN 50	DN 65	DN 80	DN 100	DN 125	DN 150	DN 200	
PN 10	D ₁	32	40	50	65	80	100	125	150	200
	D ₂	100	110	125	145	160	180	210	240	295
	D ₃	140	150	165	185	200	220	250	285	340
	S	4 x Ø19	4 x Ø19	4 x Ø19	4 x Ø19	8 x Ø19	8 x Ø19	8 x Ø19	8 x Ø23	8 x Ø23
PN 16	D ₂	100	110	125	145	160	180	210	240	295
	D ₃	140	150	165	185	200	220	250	285	340
	S	4 x Ø19	4 x Ø19	4 x Ø19	4 x Ø19	8 x Ø19	8 x Ø19	8 x Ø19	8 x Ø23	12 x Ø23
PN 25	D ₂	100	110	125	145	160	190	220	250	310
	D ₃	140	150	165	185	200	235	270	300	360
	S	4 x Ø19	4 x Ø19	4 x Ø19	8 x Ø19	8 x Ø19	8 x Ø23	8 x Ø28	8 x Ø28	12 x Ø28
PN 40	D ₂	100	110	125	145	160	190	220	250	320
	D ₃	140	150	165	185	200	235	270	300	375
	S	4 x Ø19	4 x Ø19	4 x Ø19	8 x Ø19	8 x Ø19	8 x Ø23	8 x Ø28	8 x Ø28	12 x Ø31

Loose pump flanges, ASME B16.5

ASME B16.5 is the standard used for stainless steel pump flanges.

Material of flange: AISI 316/A105.

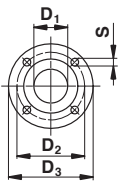

TM02 7720 3803

ASME B16.5

	Nominal diameter									
	1 1/4" ¹	1 1/2"	2"	2 1/2"	3"	4"	5"	6"	8"	
Class 300	D ₁ [mm]	32.0	76.2	90.2	107.2	125.2	150.2	175.2	205.2	260.2
	D ₂ [mm]	98.4	114.3	127.0	149.2	168.3	200.0	235.0	269.9	330.2
	D ₃ [mm]	135.0	155.0	165.0	190.0	210.0	255.0	280.0	320.0	380.0
	S [inch]	4 x Ø3/4"	4 x Ø7/8"	8 x Ø3/4"	8 x Ø7/8"	8 x Ø7/8"	8 x Ø7/8"	8 x Ø7/8"	12 x Ø7/8"	12 x Ø1"

¹ 1 1/4" is only available as fixed flange.

Loose pump flanges, JIS B 2220

JIS B 2220 is the standard used for stainless steel pump flanges. The flange dimensions are stated in mm.

Material of flange: EN 1.4408/GGG50.

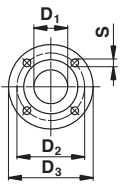

TM02 7720 3803

JIS B 2220

	Nominal diameter									
	DN 32 ¹	DN 40	DN 50	DN 65	DN 80	DN 100	DN 125	DN 150	DN 200	
20K	D ₁	32.0	76.2	90.2	107.2	125.2	150.2	175.2	205.2	260.2
	D ₂	100.0	105.0	120.0	140.0	160.0	185.0	225.0	260.0	305.0
	D ₃	135.0	150.0	165.0	178.0	200.0	225.0	270.0	305.0	350.0
	S	4 x Ø19.0	4 x Ø18.5	8 x Ø18.5	8 x Ø19.0	8 x Ø23.0	8 x Ø23.0	8 x Ø25.0	12 x Ø25.0	12 x Ø25.0

¹ DN 32 is only available as fixed flange.

15. Introduction to curves and technical data

How to read the curve charts

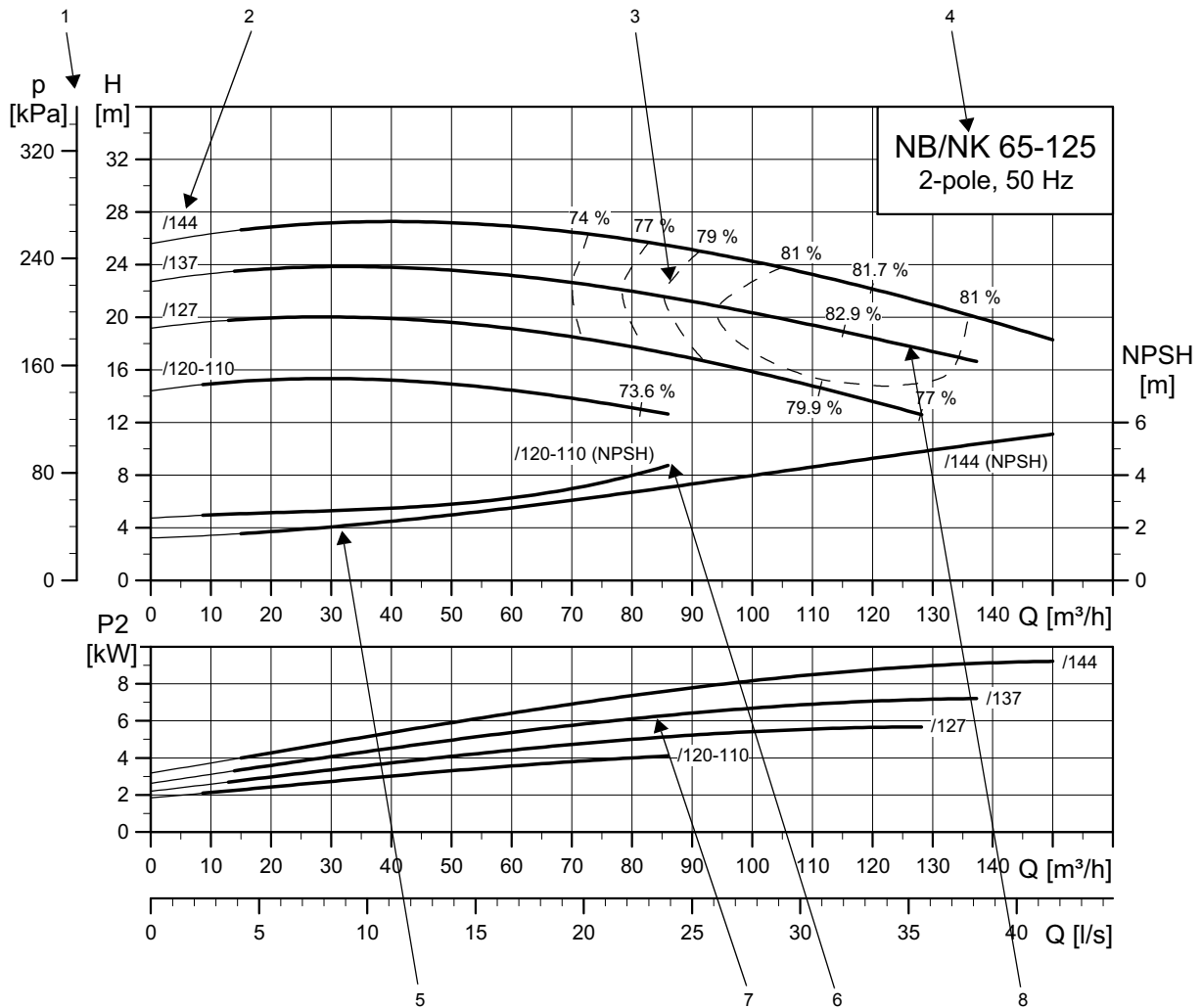

TM03 5098 3414

Pos.	Description
1	Total pump head, p [kPa] or H [m] is equal to H_{total}
2	Impeller diameter [mm]
3	Hydraulic efficiency curves are shown as dashed lines, eta [%]
4	Pump type, pole number and frequency
5	The NPSH curve is shown for maximum impeller size.
6	The NPSH curve is shown for minimum impeller size.
7	The power curve indicates pump input power P2 [kW]
8	QH curve for the individual pump. The bold curve indicates the recommended performance range.

The shown pump performance curves in [16. Performance curves](#) represent the pump in combination with an IE3 motor.

- 2-pole: P2 less than or equal to 22 kW, pump with MG motor; P2 greater than or equal to 30 kW, pump with Siemens motor.
- 4-pole: P2 less than or equal to 15 kW, pump with MG motor; P2 greater than or equal to 18.5 kW, pump with Siemens motor.
- 6-pole: Pump with Siemens motor.

Curve conditions

The guidelines below apply to the curves shown in the performance charts on pages 77 to 131.

- Tolerances are according to ISO 9906:2012 Grade 3B.
- The curves show pump performance with different impeller diameters at the nominal speed.
- The bold part of the curves show the recommended operating range.
- We do not recommend the thin parts as the possible operating range here might suggest the selection of a smaller or larger pump type.
- Do not use the pumps at minimum flow rates below $0.1 \times Q_{\max}$ because of the danger of overheating the pump.
- The curves apply to the pumping of water at a temperature of 20 °C and a kinematic viscosity of 1 mm²/s (1 cSt).
- Eta: The dashed lines show values of the hydraulic efficiency of the pump.
- NPSH: The curves show maximum values measured under the same conditions as the performance curves.
- In case of other densities than 1000 kg/m³, the outlet pressure is proportional to the density.
- When pumping liquids with a density higher than 1000 kg/m³, motors with correspondingly higher outputs must be used.
- When stuffing box shaft seal is selected for a pump, select the motor size according to ISO 5199.

Calculation of total head

The total pump head consists of the height difference between the measuring points + the differential head + the dynamic head.

$$H_{\text{total}} = H_{\text{geo}} + H_{\text{stat}} + H_{\text{dyn}}$$

H_{geo}	Height difference between measuring points.
H_{stat}	Differential head between the inlet and outlet sides of the pump.
H_{dyn}	Calculated values based on the velocity of the pumped liquid on the inlet and outlet sides of the pump.

Pump performance testing

NB, NBG, NK and NKG testers are all capable of performing hydraulic performance tests according to ISO 9906:2012 requirements.

The standard ISO 9906:2012 sets standards for "rotodynamic pumps, Hydraulic performance acceptance tests, Grades 1, 2 and 3".

Performance acceptance grades

Six pump-performance-test acceptance grades, 3B, 2B, 2U, 1B, 1E and 1U are defined in ISO 9906:2012.

Acceptance grade	Mandatory measurements		Optional measurements	
	Q	H	P1	Eta-tot
3B	± 9 %	± 7 %	+ 9 %	- 7 %
2B	± 8 %	± 5 %	+ 8 %	- 5 %
2U	+ 16 %	+ 10 %	+ 16 %	- 5 %
1B	± 5 %	± 3 %	+ 4 %	- 3 %
1E	± 5 %	± 3 %	+ 4 %	≥ 0 %
1U	+ 10 %	+ 6 %	+ 10 %	≥ 0 %

- Q: Flow
- H: Head
- P1: Total consumed power
- Eta-tot: Total efficiency

These tolerance grades can be used in the contract between the pump manufacturer and the purchaser, or they can be used in a default tolerance factor which will apply if no specific tolerance grade has been agreed between the manufacturer and the customer. The performance acceptance grades are explained in section [Specifying acceptance grades](#) on pages 75 and 76, showing the performance grades related to an ordinary pump curve.

The guarantee point

According to ISO 9906:2012 the acceptance-grade tolerance applies to one guarantee point. A guarantee point is defined by a guaranteed flow and a guaranteed head. In addition either minimum total efficiency or maximum total input power may be guaranteed at the specified conditions.

This means that the standard sets guidelines for a duty point guaranteed for the following:

- Q and H - or
- Q, H and total efficiency (Eta-total) - or
- Q, H and total consumed power (P1).

The guarantee point is defined by a minimum of five measured test points.

Example on a duty point test living up to ISO 9906:2012 requirements

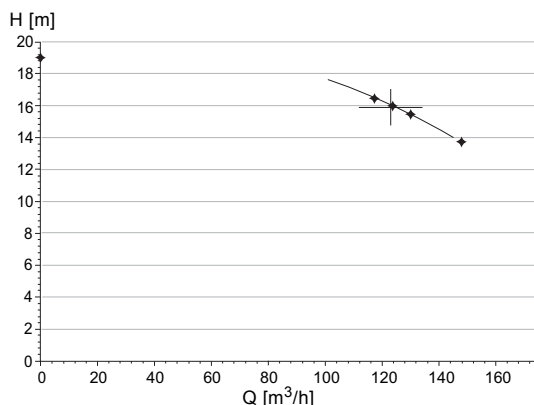

Fig. 67 Five measured test points are used to verify one guarantee point

Evaluation of performance

The test must show that the measured pump curve touches or passes through a tolerance surrounding the guarantee point, as defined by the selected acceptance grade.

Guarantee-point evaluation must be made at the rated speed, which for NB, NBG, NK, NKG pumps means 50 Hz or 60 Hz.

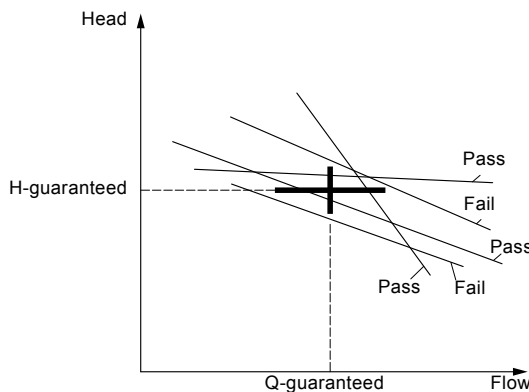

Fig. 68 Pump curves that either pass or fail to cross the tolerance cross of the guarantee point

Performance-test types for end-suction pumps

Two types of performance tests are available for NB(E), NBG(E), NK(E), NKG(E) pumps:

- duty-point-verification test
- curve test.

Tests carried out on NB, NK pumps

- Tests are saved for at least five years and can be traced using the pump's unique serial number.
- It is not possible to change acceptance grade on an already tested and supplied pump - if this should be required a re-test of the pump is needed.
- Witness testing can be arranged.

Duty-point-verification test, Grades 3B, 2B, 2U, 1B, 1E and 1U

This test method offers the possibility to perform a duty-point verification of the following:

- Q and H - or
- Q, H and total efficiency (Eta-tot) - or
- Q, H and total consumed power (P1).

Acceptance grade	Mandatory measurements		Optional measurements	
	Q	H	P1	Eta-tot
3B	Standard		On request	
2B	On request		On request	
2U	On request		On request	
1B	On request		On request	
1E	On request		On request	
1U	On request		On request	

What Grundfos is able to guarantee for the different acceptance grades will be evaluated case by case. Contact your local sales company on this.

Grundfos makes duty-point verification according to ISO 9906:2012 for one guarantee point at full speed, 50 or 60 Hz. The customer must tell Grundfos which duty point to verify.

The requested duty point is verified by five measured points.

Grade 1U duty-point verification

The following example illustrates performance testing according to Grade 1U.

Flow and head are mandatory and efficiency or power consumption, P1, is optional.

Tolerances for a Grade 1U test are as follows:

- Flow: + 10 %
- Head: + 6 %
- Efficiency: 0 %, only equal to or better than the guaranteed value
- P1: + 10 %

1. Q, H and Eta-tot is tested and verified

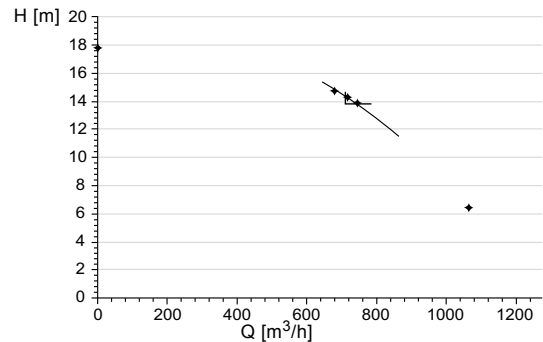

Fig. 69 Measured values for flow and head

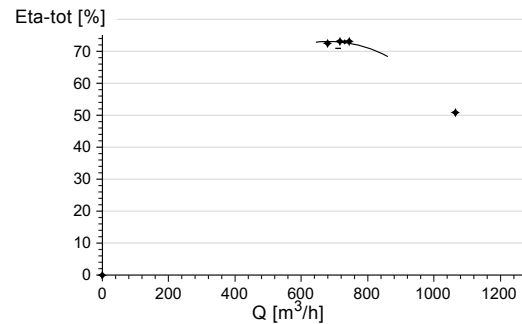

Fig. 70 Measured values for total efficiency

TM07 1542 1618

TM07 1543 1618

2. Q, H and P1 is tested and verified

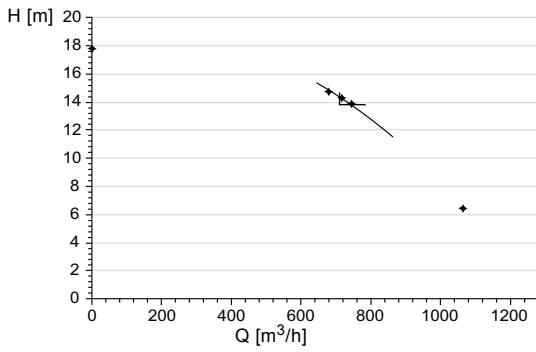

Fig. 71 Measured values for flow and head

TM07 1542 1618

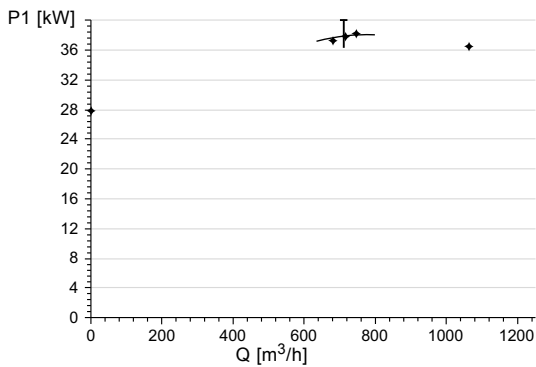

Fig. 72 Measured values for consumed power

TM07 1545 1617

Note that other points than the guarantee point can be measured and displayed in a curve-test report according to Grade 3B tolerances.

Curve test, Grade 3B

This test method is developed by Grundfos and is based on ISO 9906:2012 performance acceptance grade 3B tolerances: $Q = \pm 9\%$, $H = \pm 7\%$.

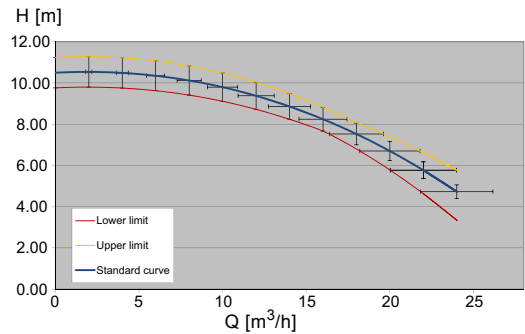

TM07 1515 1618

Fig. 73 Q-H curve with tolerance crosses on complete performance range

On fig. 73 tolerance crosses according to Grade 3B have been distributed across the complete performance range of a pump. We generate the upper and lower limit of the performance curve by drawing two curves at the outlines of these crosses.

When the pump is tested and the measured point is located within the range between upper and lower limit, it is qualified to ISO 9906:2012 Grade 3B tolerances. This way of qualifying the pump performance is stricter than a duty-point-verification test for Grade 3B.

How does Grundfos make curve testing for NB(E), NK(E), NBG(E), NKG(E) pumps

Grundfos makes the curve test in one of the following two ways:

- a reference-curve test
- a performance-curve test.

Reference-curve test, Grade 3B

A reference test is made when no curve-test report is specified with the order. Three or four test points are measured depending on production site, and no curve-test report is supplied with the pump.

Measurements are made to maintain and observe continuous quality and to ensure that the supplied pump is within test-grade tolerances. Test-grade tolerances are set as for Grade 3B but without certification.

Example of a reference-curve test

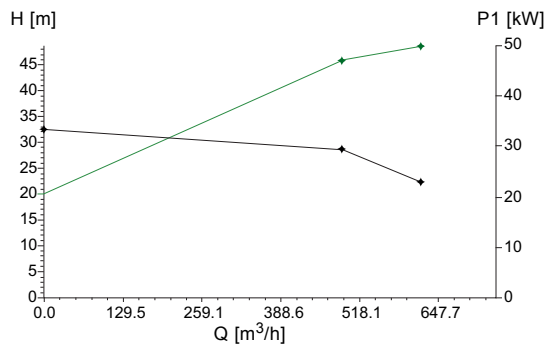

Fig. 74 Measured values for tested pump

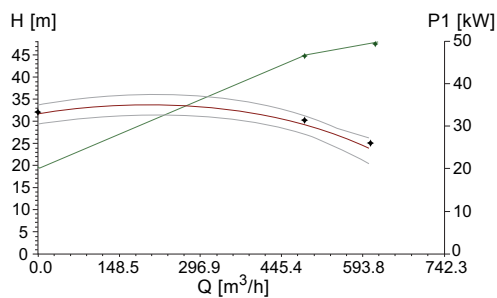

Fig. 75 The values in fig. 74 calculated to a reference speed for comparison to a reference performance curve

If a pump-performance report is requested at a later stage only reference-test data are available.

Performance-curve test, Grade 3B

A performance-curve test is made when a curve test report is specified with the order.

The pump is tested at pre-specified flows, distributed over the full pump curve - minimum five points, and test grade tolerances are set as for Grade 3B but without certification.

Example of an NB, NK, NBE, NKE curve test

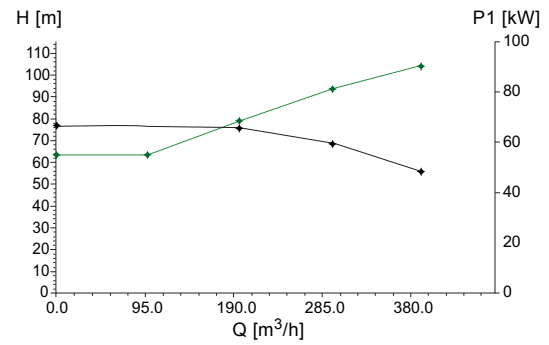

Fig. 76 Measured values for tested pump

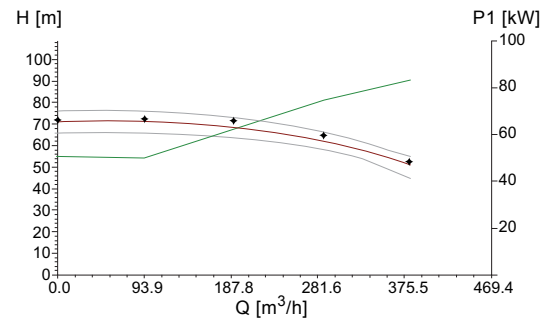

Fig. 77 The values in fig. 76 calculated to a reference speed for comparison to a reference performance

If the customer requires more points on the curve to be checked, individual measurements must be made and this is not part of the performance curve test.

Static high pressure test

All produced pumps undergo a static high pressure test of 1.5 x PN (pressure rating of the pump)

Specifying acceptance grades

The graphs in the table on page 76 show the tolerances as stated in the standard, related to an ordinary pump curve. The graphs also show which pump performance to expect if the customer, having the same pump to start with, orders a pump with the same guarantee point for different tolerances (B, E or U) within the acceptance grades.

In some cases it will not be possible to fulfil the same guarantee point for a unilateral tolerance as it will for a bilateral tolerance. This is indicated by the lowered curve for "E" and "U" grades.

If the requested guarantee point is the same for a Grade U pump as for a Grade B pump, the consequence of the production tolerances could result in a larger pump being required to obtain the requested duty point.

What Grundfos is able to guarantee for the different acceptance grades will be evaluated case by case. Contact your local sales company on this.

Acceptance grades and tolerances

Acceptance grade B

This acceptance grade refers to grades with a bilateral tolerance on flow and head and with a tolerance on efficiency.

Acceptance grade E

This acceptance grade refers to a grade with a bilateral tolerance on flow and head but without tolerance on efficiency.

Acceptance grade U

This acceptance grade refers to a grade with a unilateral tolerance on flow and head. For the 2U grade there is a tolerance on efficiency. For the 1U grade there is no tolerance on efficiency.

Note that if the acceptance grade changes from Grade 1B to 1U, the customer does not necessarily get a better pump with a higher efficiency. More likely, he gets a pump where the performance is always to the positive side of the guarantee point.

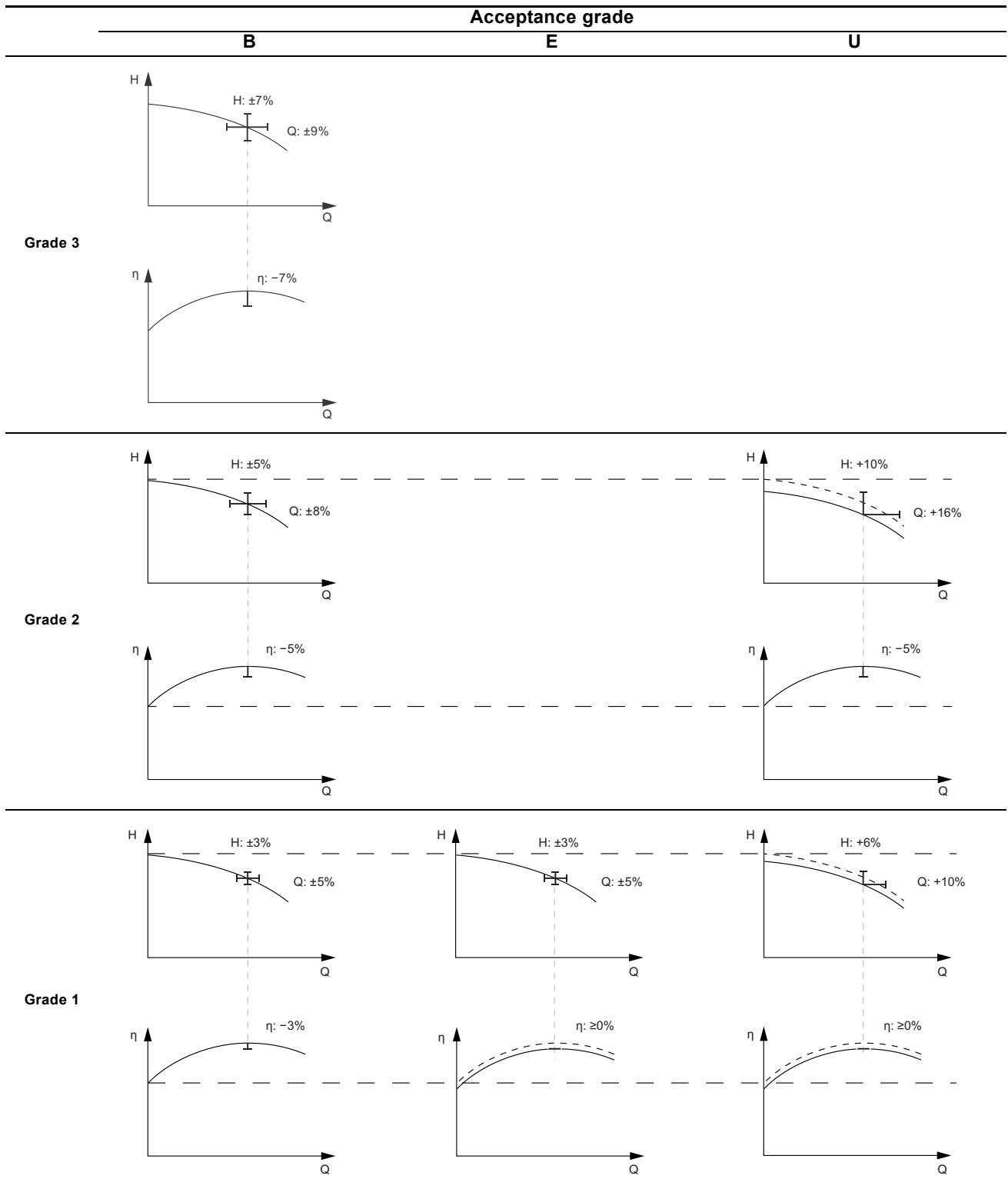

16. Performance curves

Overview

2-pole		4-pole		6-pole	
Pump type	See page	Pump type	See page	Pump type	See page
<i>NB, NK 32-125.1</i>	78	<i>NB, NK 32-125.1</i>	96	<i>NB, NK 100-160</i>	121
<i>NB, NK 32-125</i>	78	<i>NB, NK 32-125</i>	96	<i>NB, NK 100-200</i>	121
<i>NB, NK 32-160.1</i>	79	<i>NB, NK 32-160.1</i>	97	<i>NB, NK 100-250</i>	122
<i>NB, NK 32-160</i>	79	<i>NB, NK 32-160</i>	97	<i>NB, NK 100-315</i>	122
<i>NB, NK 32-200.1</i>	80	<i>NB, NK 32-200.1</i>	98	<i>NB, NK 100-400</i>	123
<i>NB, NK 32-200</i>	80	<i>NB, NK 32-200</i>	98	<i>NB, NK 125-200</i>	123
<i>NB, NK 32-250</i>	81	<i>NB, NK 32-250</i>	99	<i>NB, NK 125-250</i>	124
<i>NB, NK 40-125</i>	81	<i>NB, NK 40-125</i>	99	<i>NB, NK 125-315</i>	124
<i>NB, NK 40-160</i>	82	<i>NB, NK 40-160</i>	100	<i>NB, NK 125-400</i>	125
<i>NB, NK 40-200</i>	82	<i>NB, NK 40-200</i>	100	<i>NB, NK 125-500</i>	125
<i>NB, NK 40-250</i>	83	<i>NB, NK 40-250</i>	101	<i>NB, NK 150-200</i>	126
<i>NB, NK 40-315</i>	83	<i>NB, NK 40-315</i>	101	<i>NB, NK 150-250</i>	126
<i>NB, NK 50-125</i>	84	<i>NB, NK 50-125</i>	102	<i>NB, NK 150-315.2</i>	127
<i>NB, NK 50-160</i>	84	<i>NB, NK 50-160</i>	102	<i>NB, NK 150-315</i>	127
<i>NB, NK 50-200</i>	85	<i>NB, NK 50-200</i>	103	<i>NB, NK 150-400</i>	128
<i>NB, NK 50-250</i>	85	<i>NB, NK 50-250</i>	103	<i>NB, NK 150-500</i>	128
<i>NB, NK 50-315</i>	86	<i>NB, NK 50-315</i>	104	<i>NB, NK 200-400</i>	129
<i>NB, NK 65-125</i>	86	<i>NB, NK 65-125</i>	104	<i>NB, NK 200-450</i>	129
<i>NB, NK 65-160</i>	87	<i>NB, NK 65-160</i>	105	<i>NB, NK 250-350</i>	130
<i>NB, NK 65-200</i>	87	<i>NB, NK 65-200</i>	105	<i>NB, NK 250-400</i>	130
<i>NB, NK 65-250</i>	88	<i>NB, NK 65-250</i>	106	<i>NB, NK 250-450</i>	131
<i>NB, NK 65-315</i>	88	<i>NB, NK 65-315</i>	106	<i>NB, NK 250-500</i>	131
<i>NB, NK 80-160</i>	89	<i>NB, NK 80-160</i>	107		
<i>NB, NK 80-200</i>	89	<i>NB, NK 80-200</i>	107		
<i>NB, NK 80-250</i>	90	<i>NB, NK 80-250</i>	108		
<i>NB, NK 80-315</i>	90	<i>NB, NK 80-315</i>	108		
<i>NB, NK 100-160</i>	91	<i>NB, NK 80-400</i>	109		
<i>NB, NK 100-200</i>	91	<i>NB, NK 100-160</i>	109		
<i>NB, NK 100-250</i>	92	<i>NB, NK 100-200</i>	110		
<i>NB, NK 100-315</i>	92	<i>NB, NK 100-250</i>	110		
<i>NB, NK 125-200</i>	93	<i>NB, NK 100-315</i>	111		
<i>NB, NK 125-250</i>	93	<i>NB, NK 100-400</i>	111		
<i>NB, NK 125-315</i>	94	<i>NB, NK 125-200</i>	112		
<i>NB, NK 150-200</i>	94	<i>NB, NK 125-250</i>	112		
<i>NB, NK 150-250</i>	95	<i>NB, NK 125-315</i>	113		
<i>NB, NK 150-315.2</i>	95	<i>NB, NK 125-400</i>	113		
		<i>NB, NK 125-500</i>	114		
		<i>NB, NK 150-200</i>	114		
		<i>NB, NK 150-250</i>	115		
		<i>NB, NK 150-315.2</i>	115		
		<i>NB, NK 150-315</i>	116		
		<i>NB, NK 150-400</i>	116		
		<i>NB, NK 150-500</i>	117		
		<i>NB, NK 200-400</i>	117		
		<i>NB, NK 200-450</i>	118		
		<i>NB, NK 250-350</i>	118		
		<i>NB, NK 250-400</i>	119		
		<i>NB, NK 250-450</i>	119		
		<i>NB, NK 250-500</i>	120		

2-pole

NB, NK 32-125.1

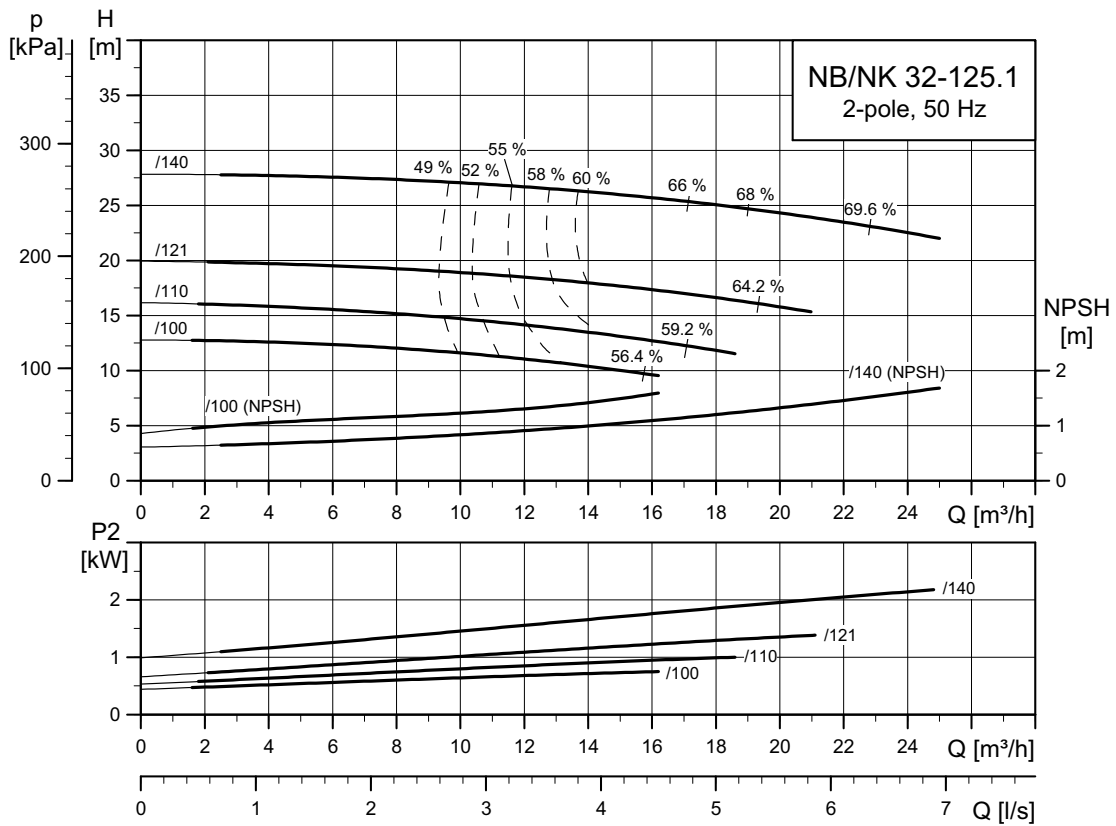

TM03 5081 3414

NB, NK 32-125

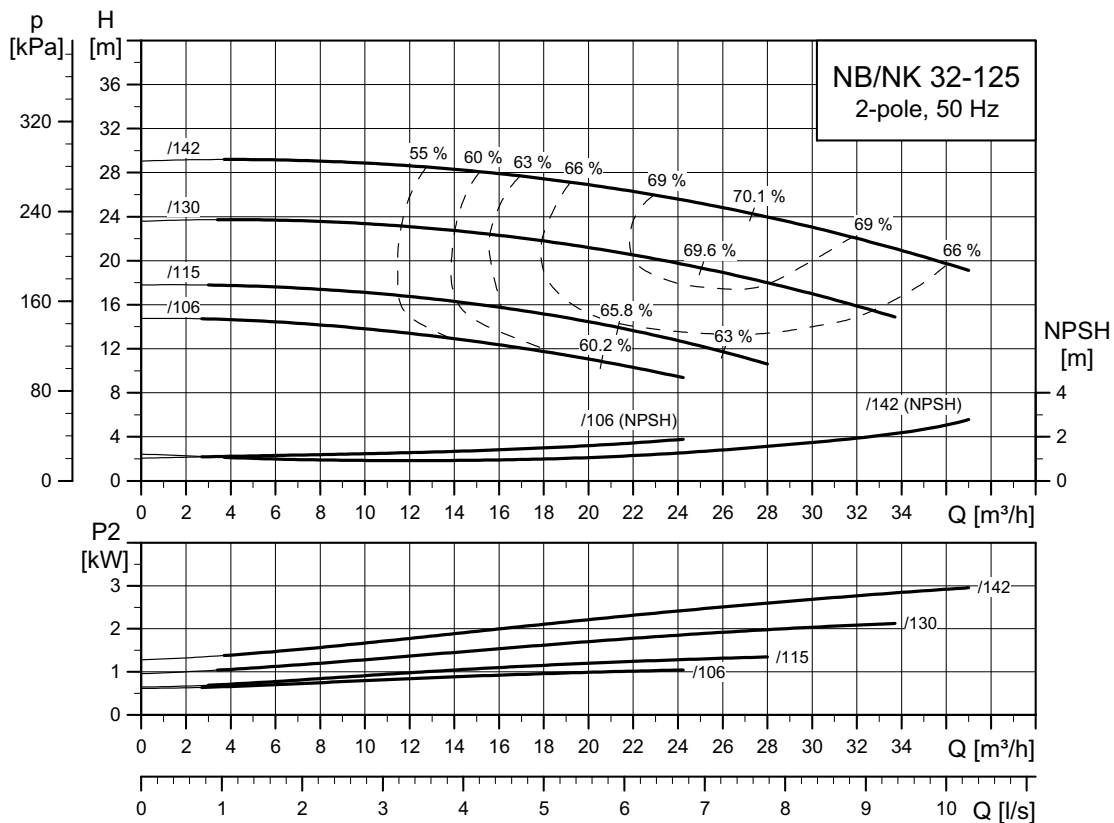

TM03 5084 3414

NB, NK 32-160.1

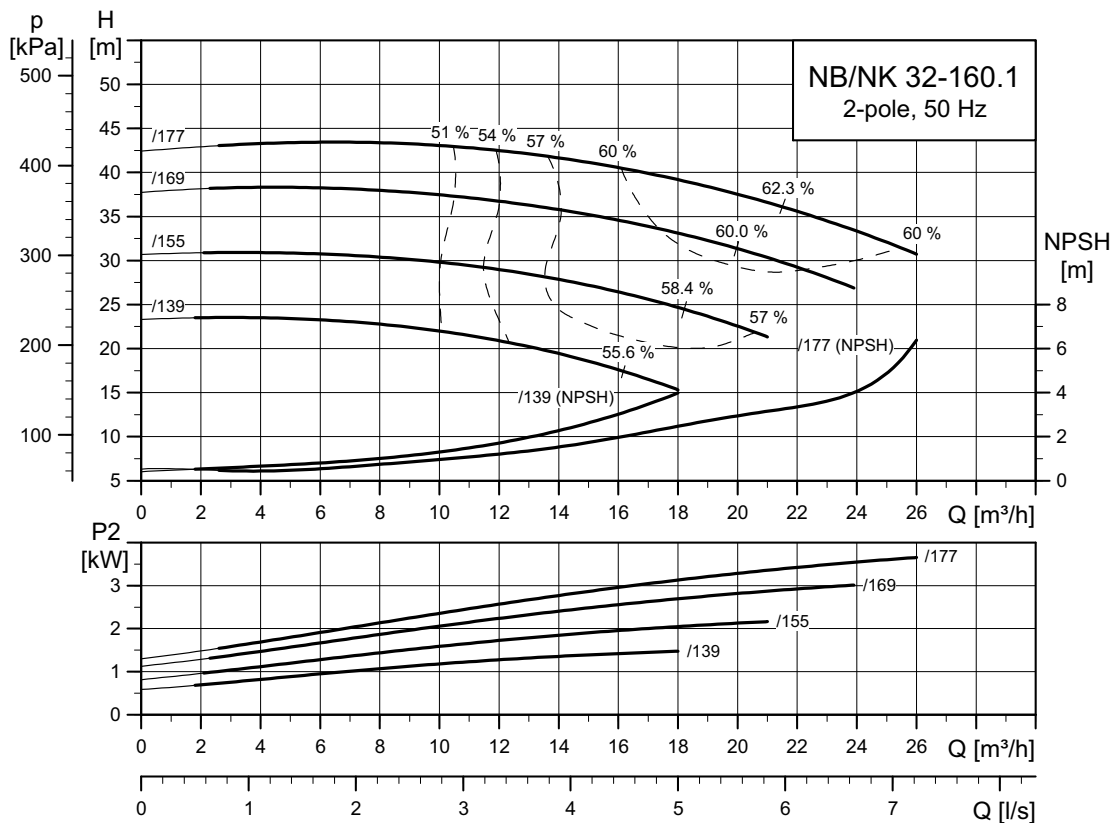

TM03 5082 3414

NB, NK 32-160

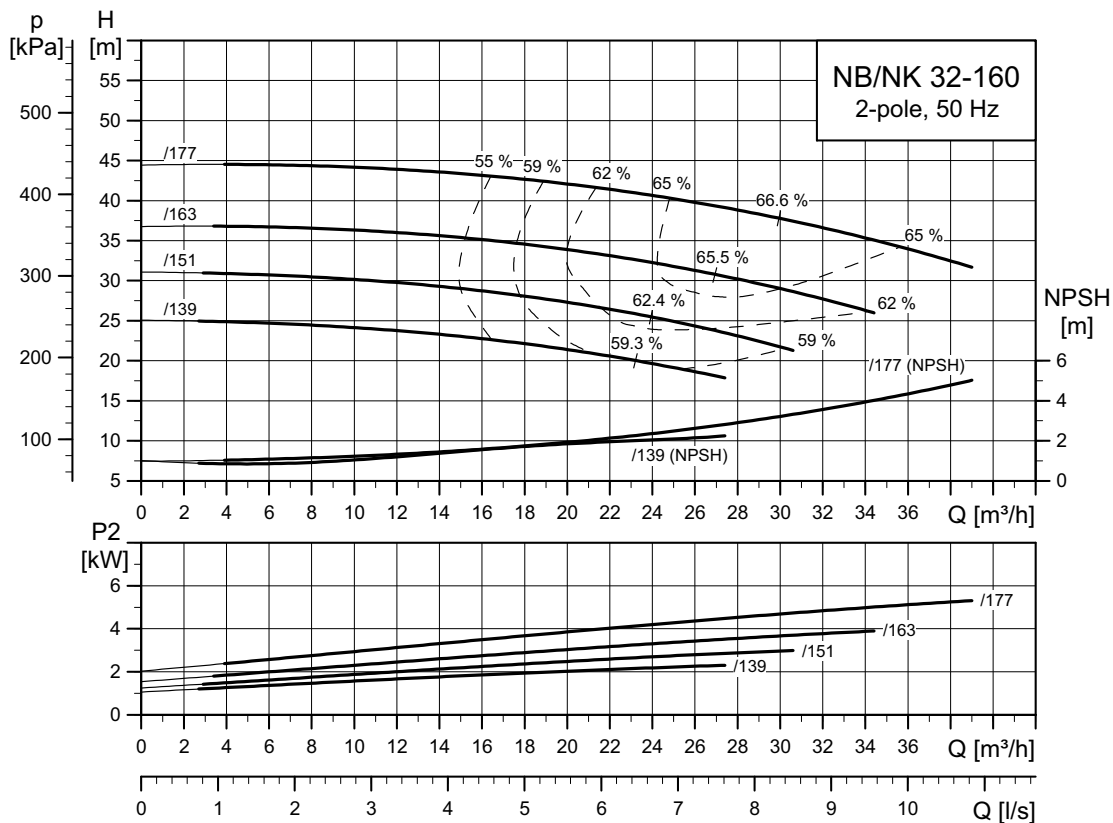

TM03 5085 3414

NB, NK 32-200.1

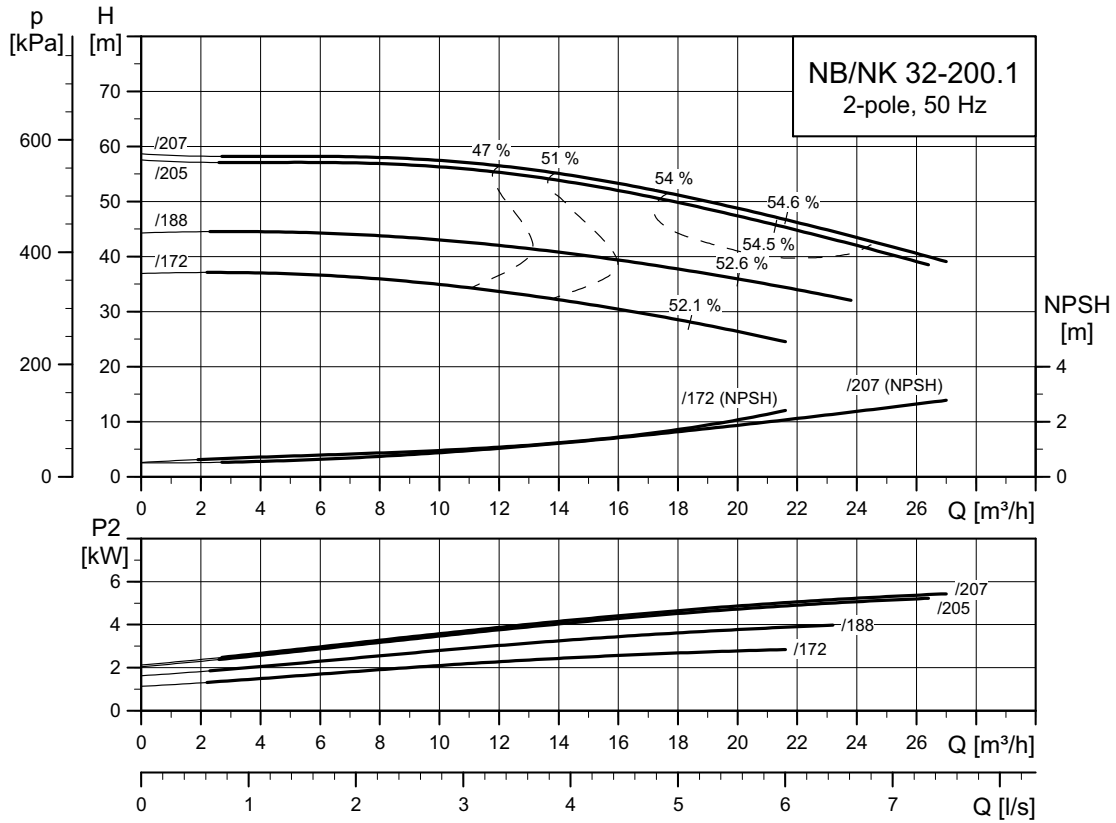

TM03 5083 3414

NB, NK 32-200

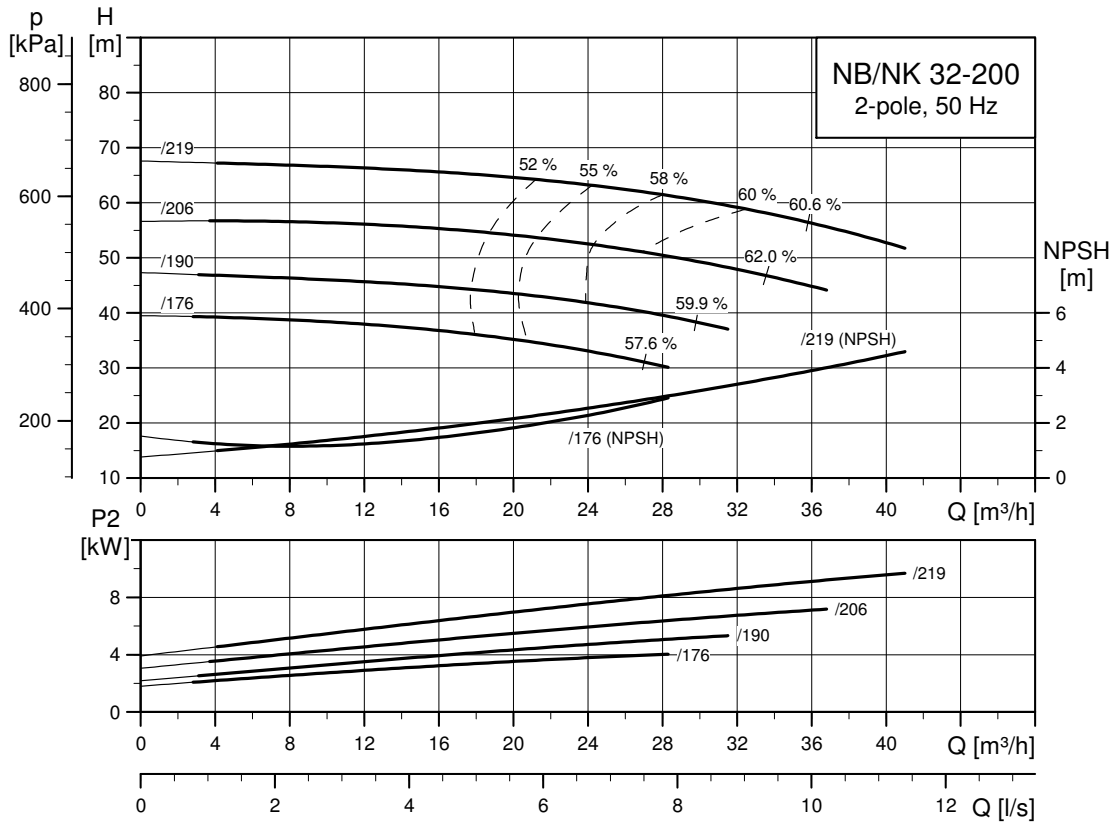

TM03 5086 1118

NB, NK 32-250

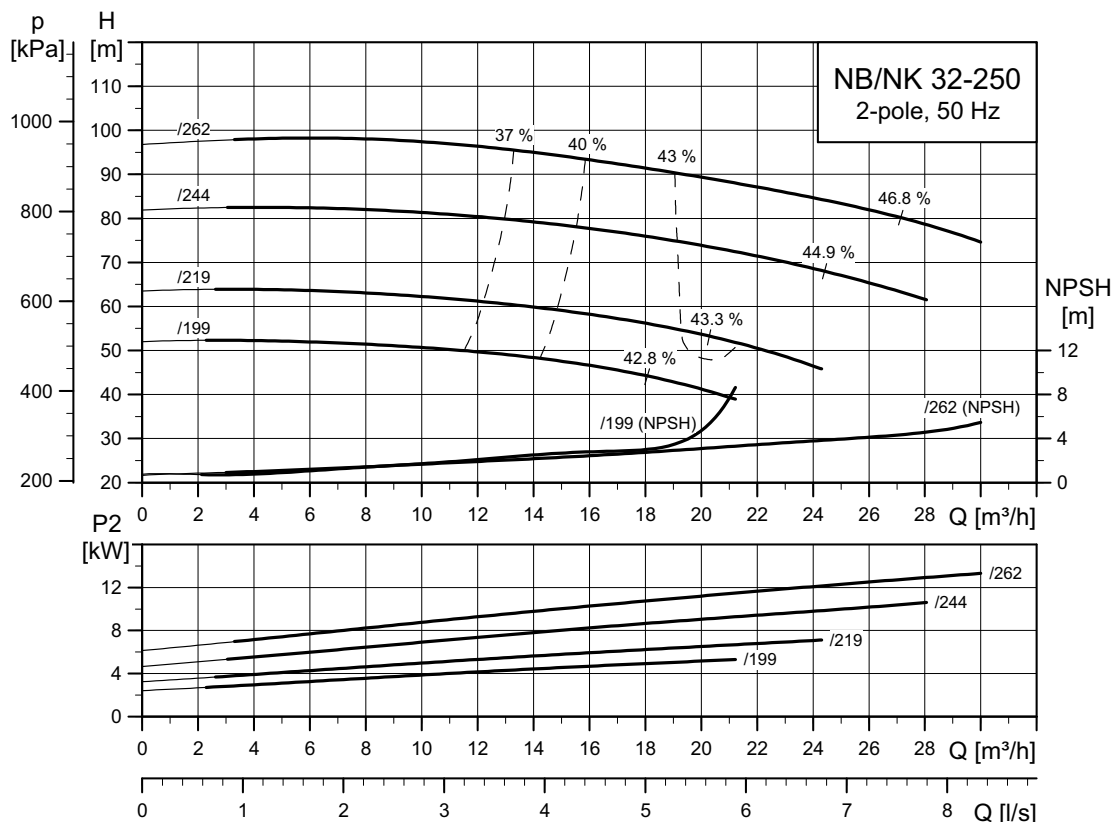

TM03 5087 3414

NB, NK 40-125

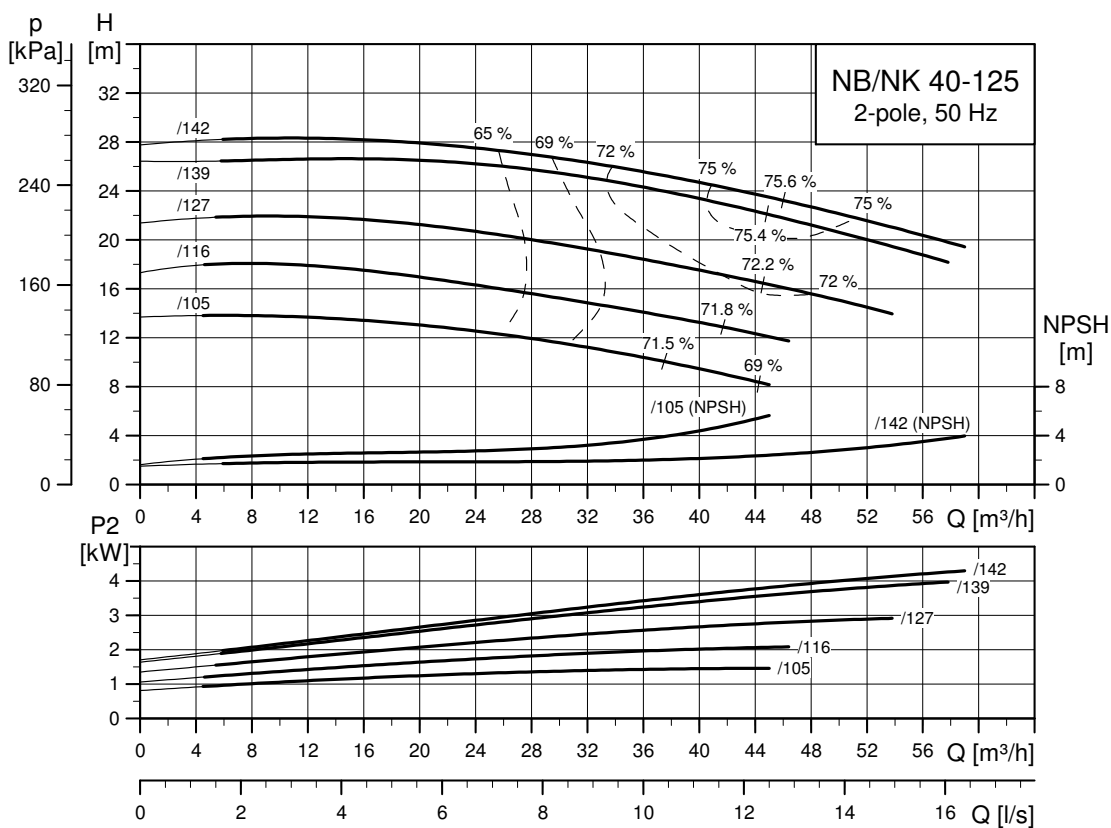

TM03 5088 1918

NB, NK 40-160

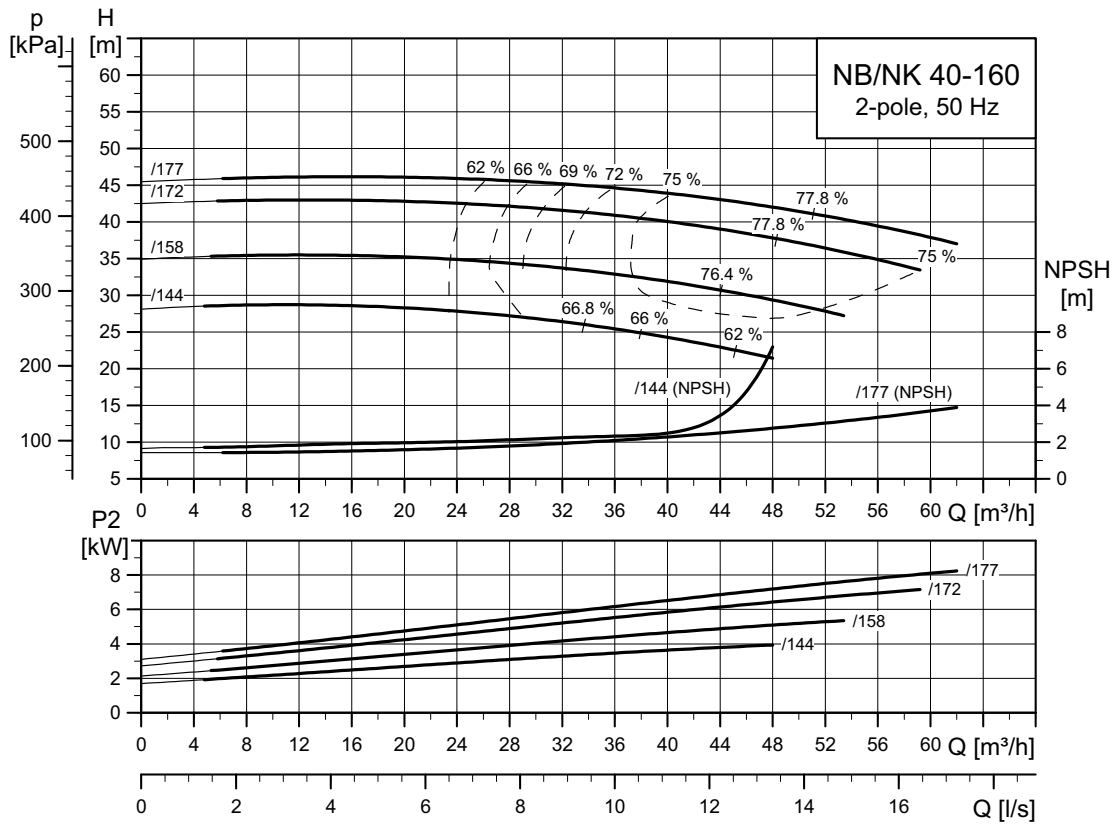

TM03 5089 3414

NB, NK 40-200

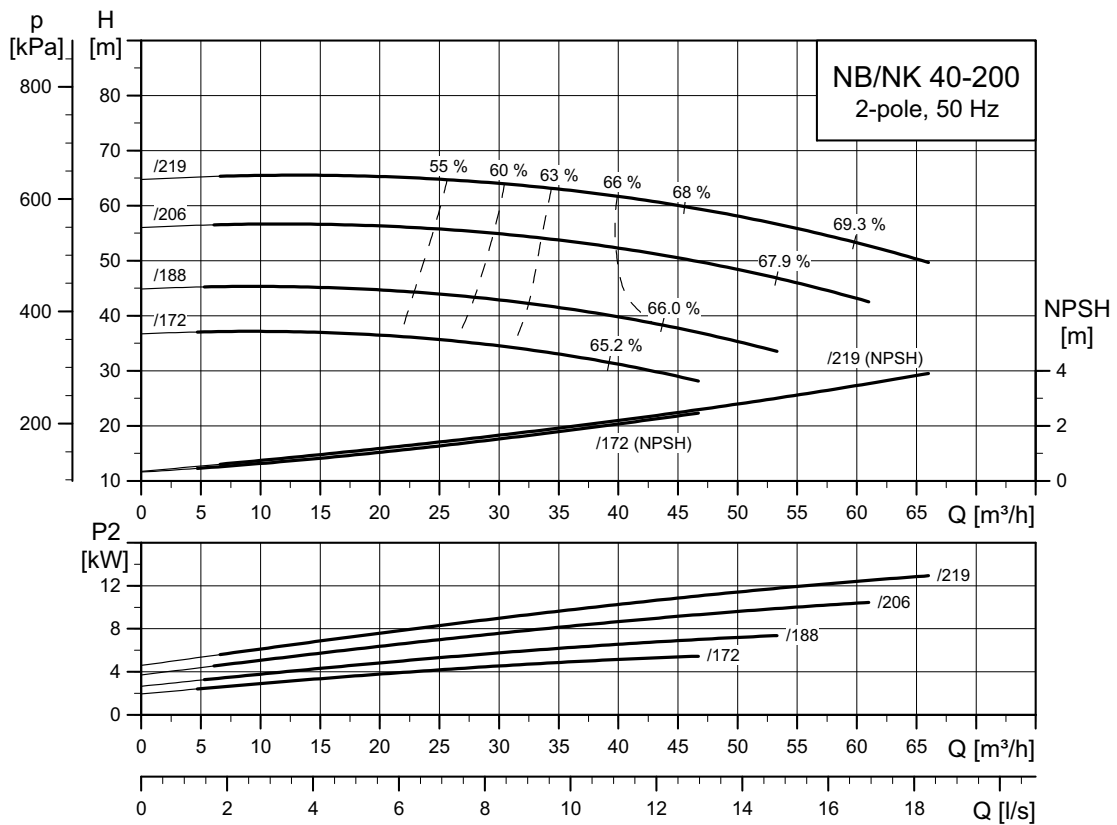

TM03 5090 3414

NB, NK 40-250

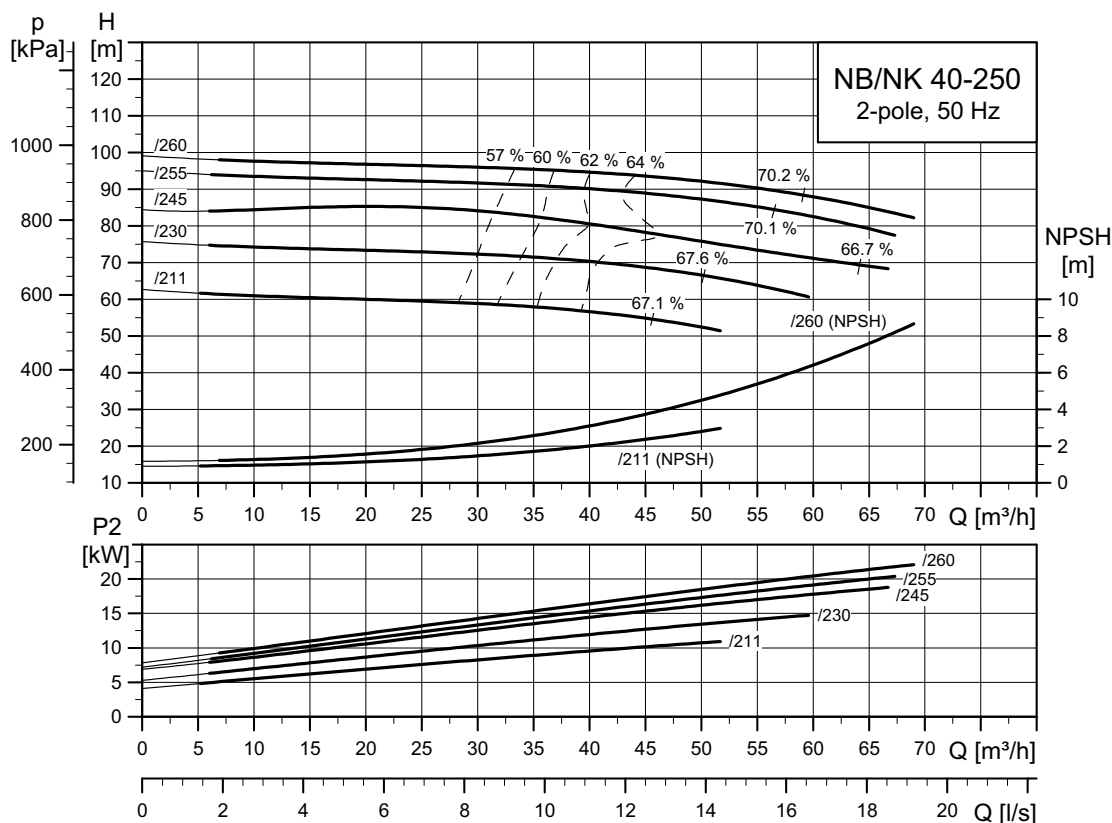

TM03 5091 3414

NB, NK 40-315

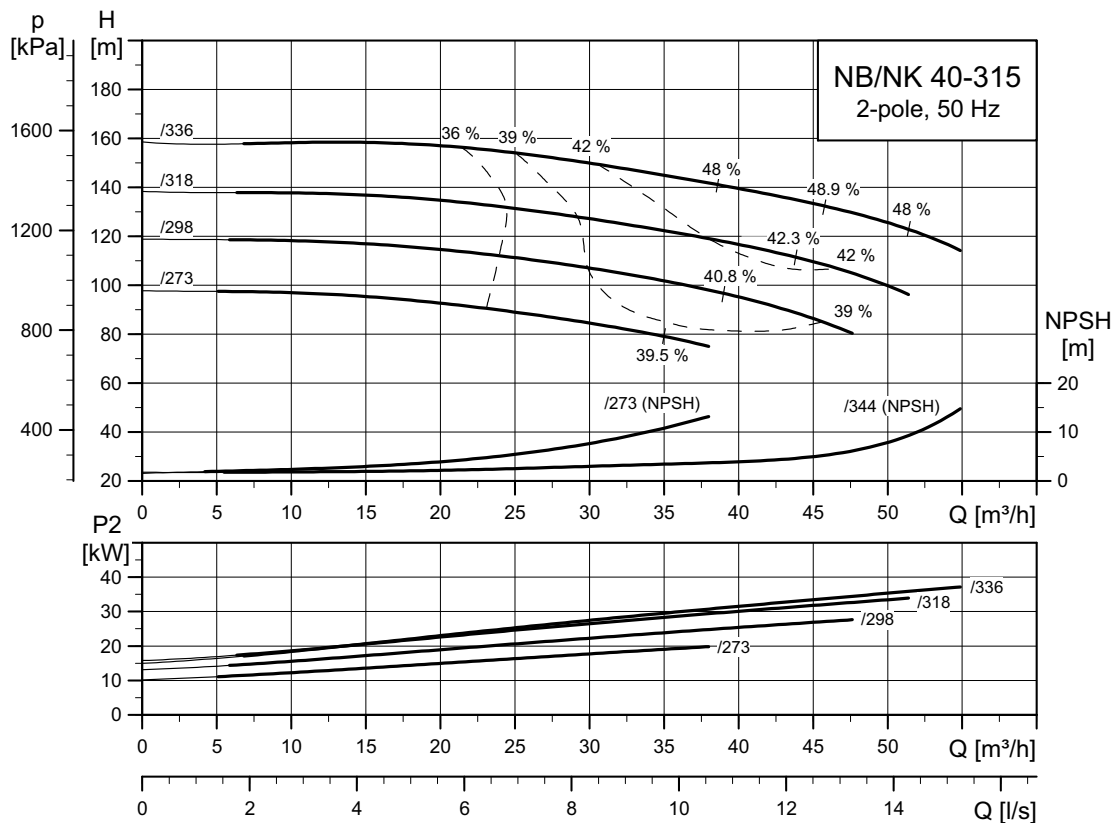

TM03 5092 3414

NB, NK 50-125

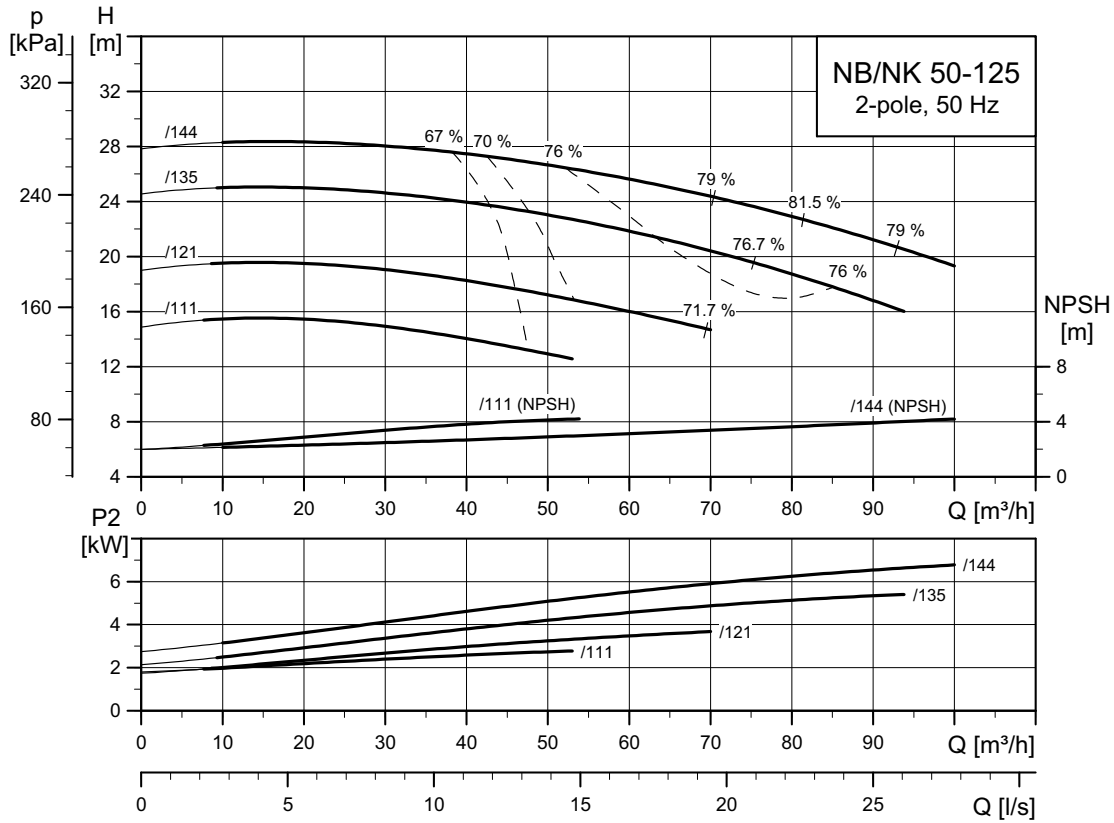

TM03 5093 3414

NB, NK 50-160

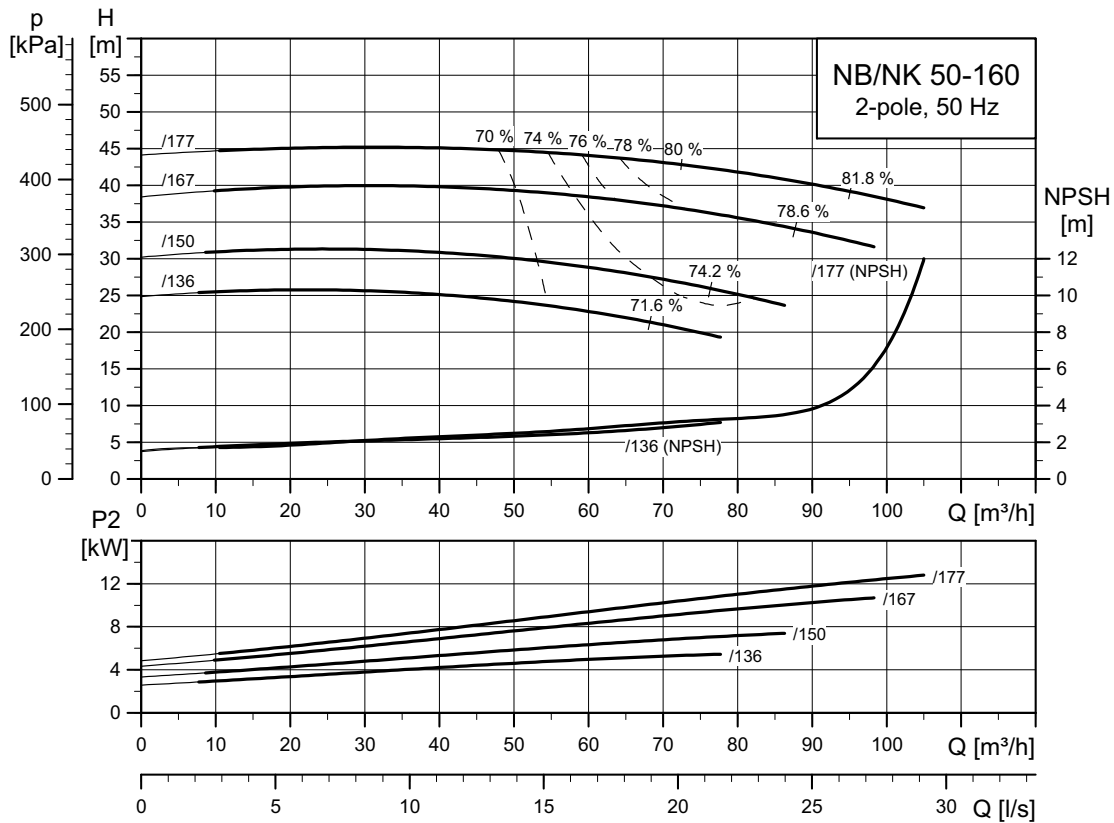

TM03 5094 3414

NB, NK 50-200

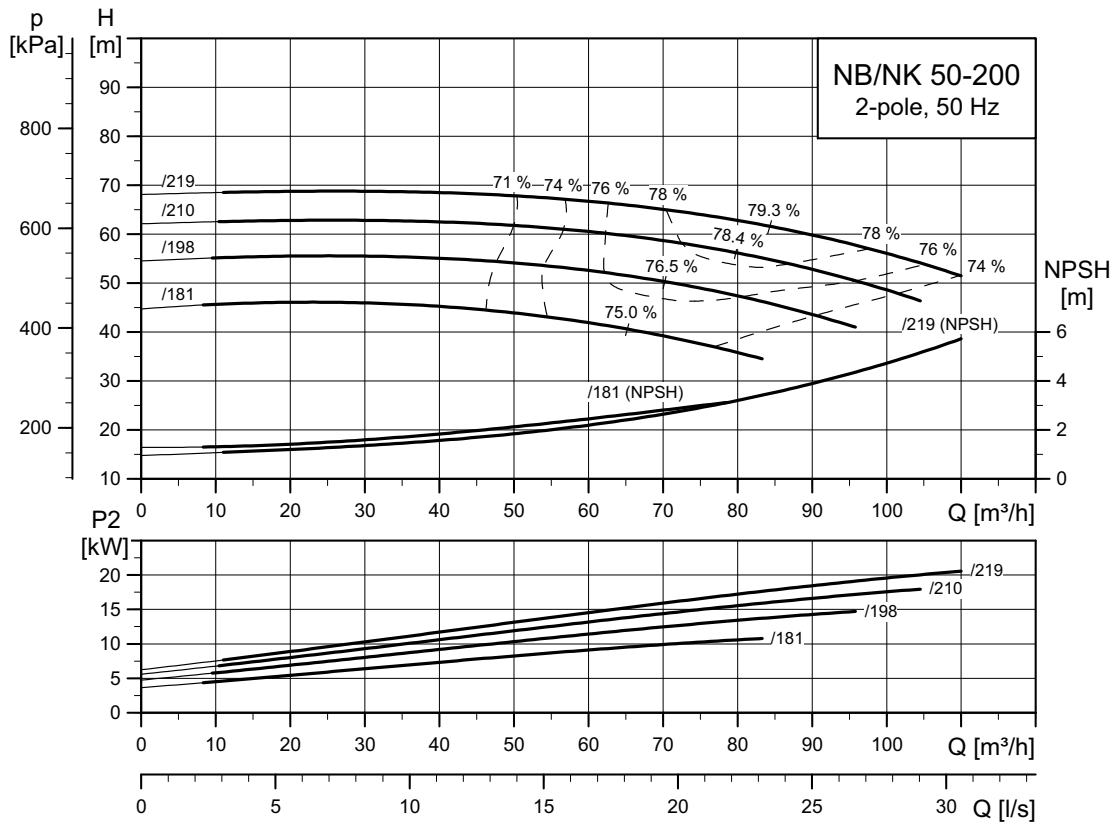

TM03 5095 3414

NB, NK 50-250

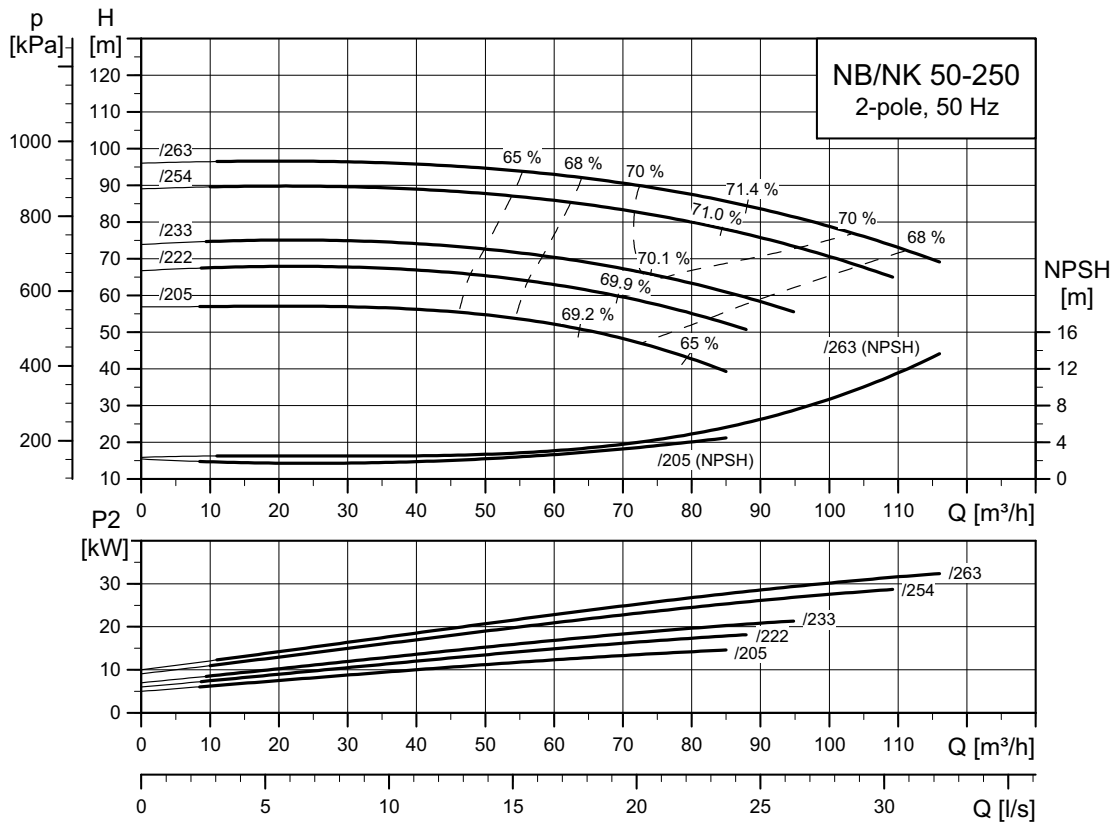

TM03 5096 3414

NB, NK 50-315

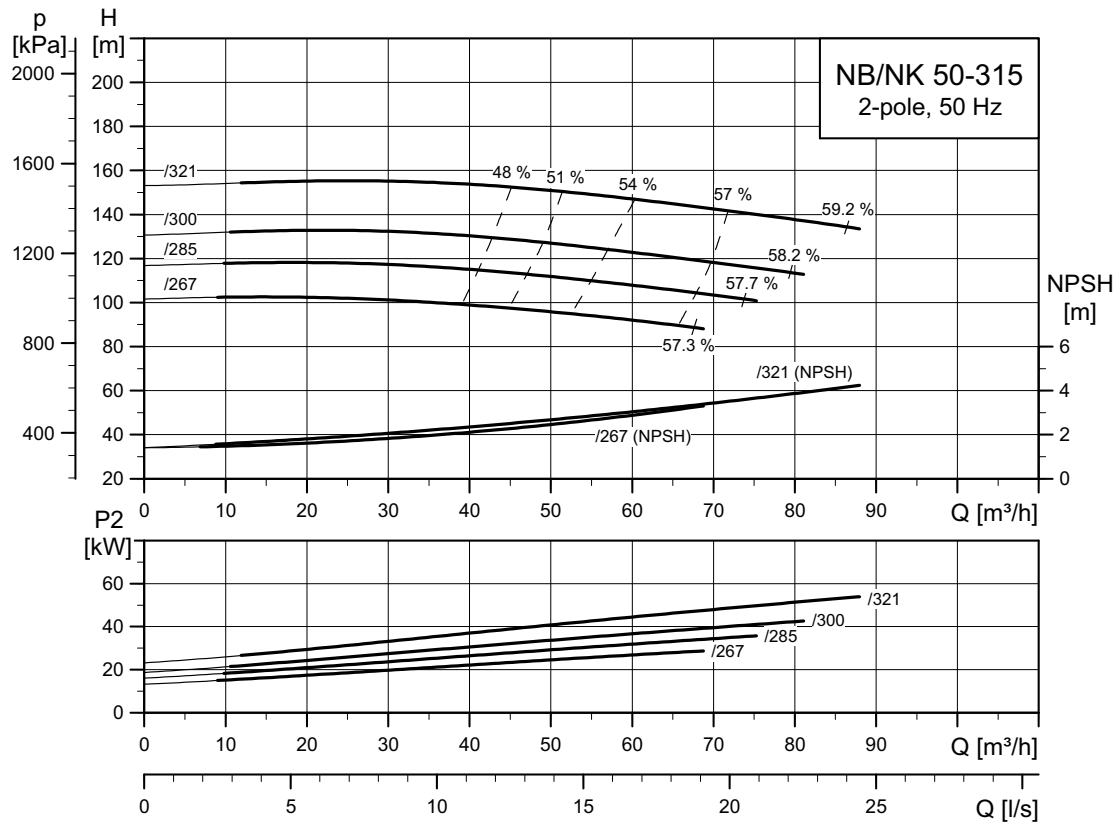

TM03 5097 3414

NB, NK 65-125

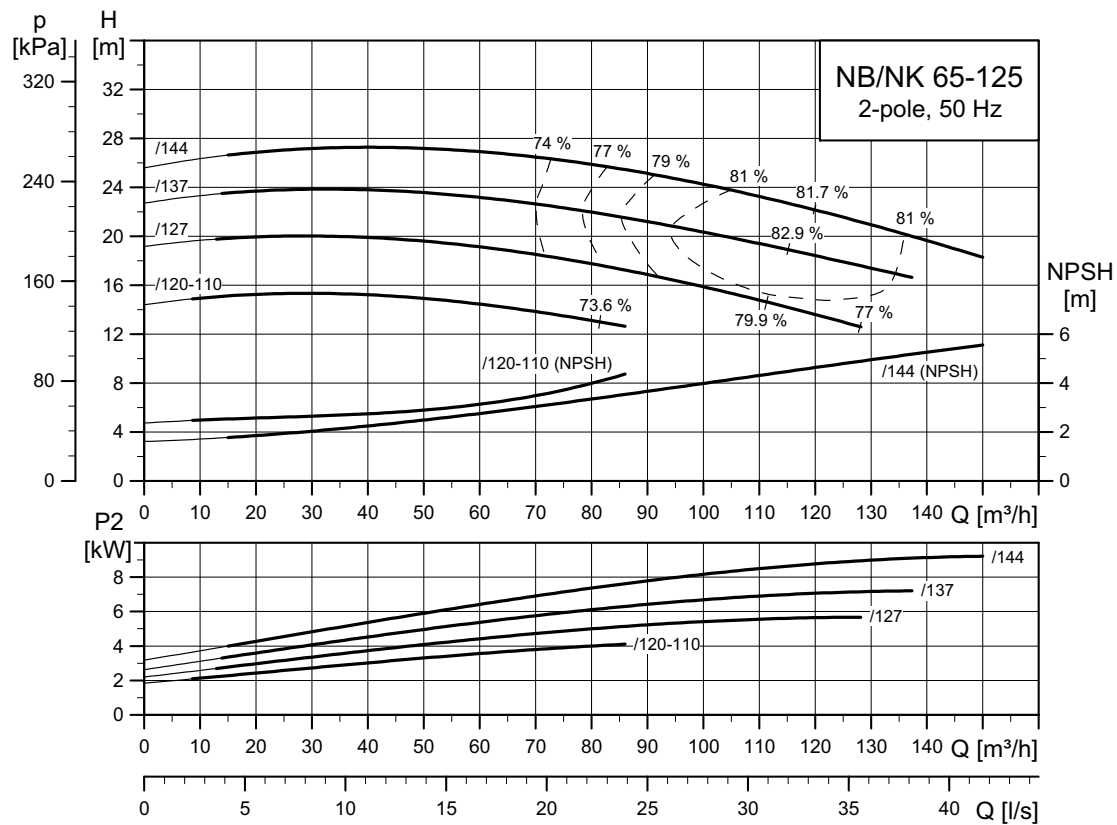

TM03 5098 3414

NB, NK 65-160

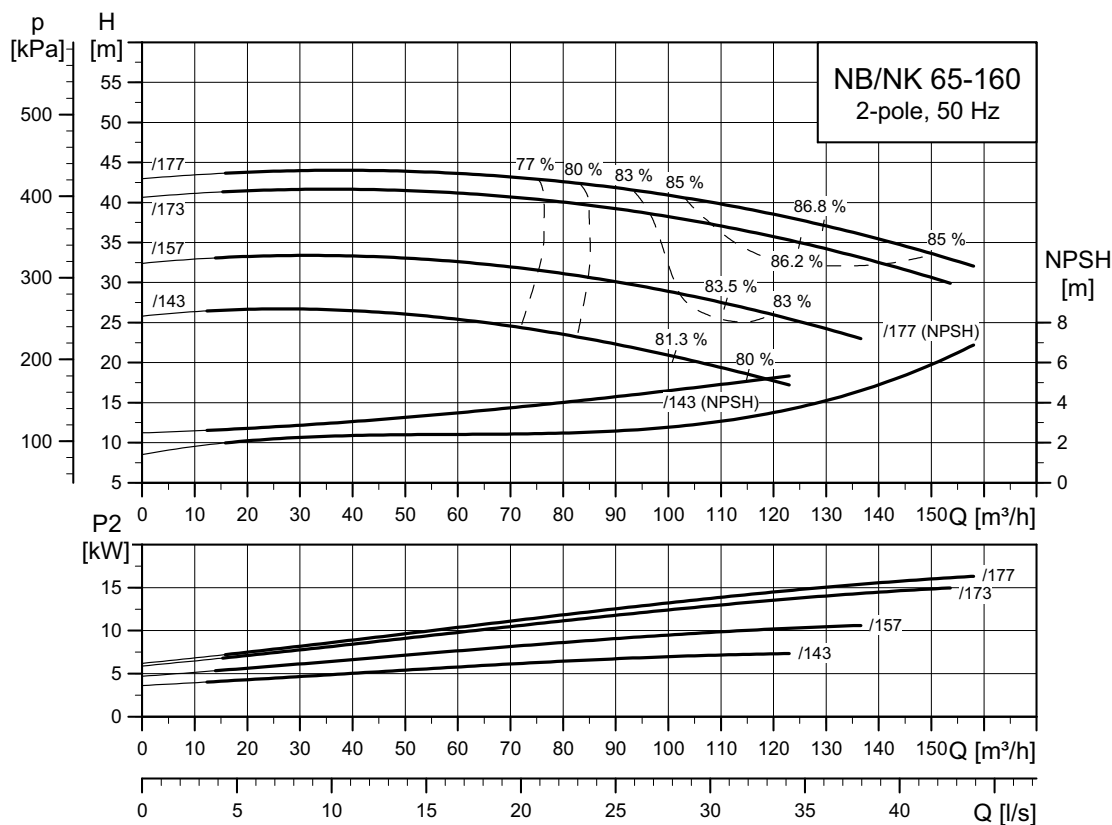

TM03 5099 3414

NB, NK 65-200

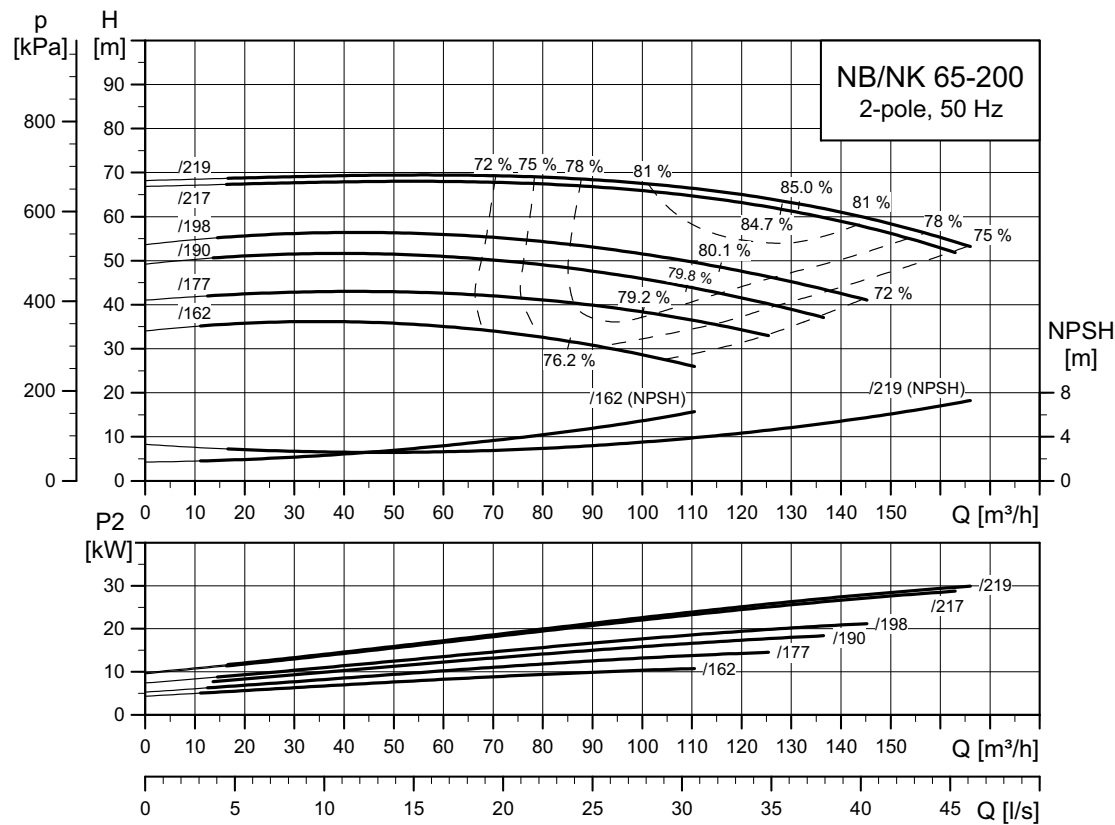

TM03 5100 3414

NB, NK 65-250

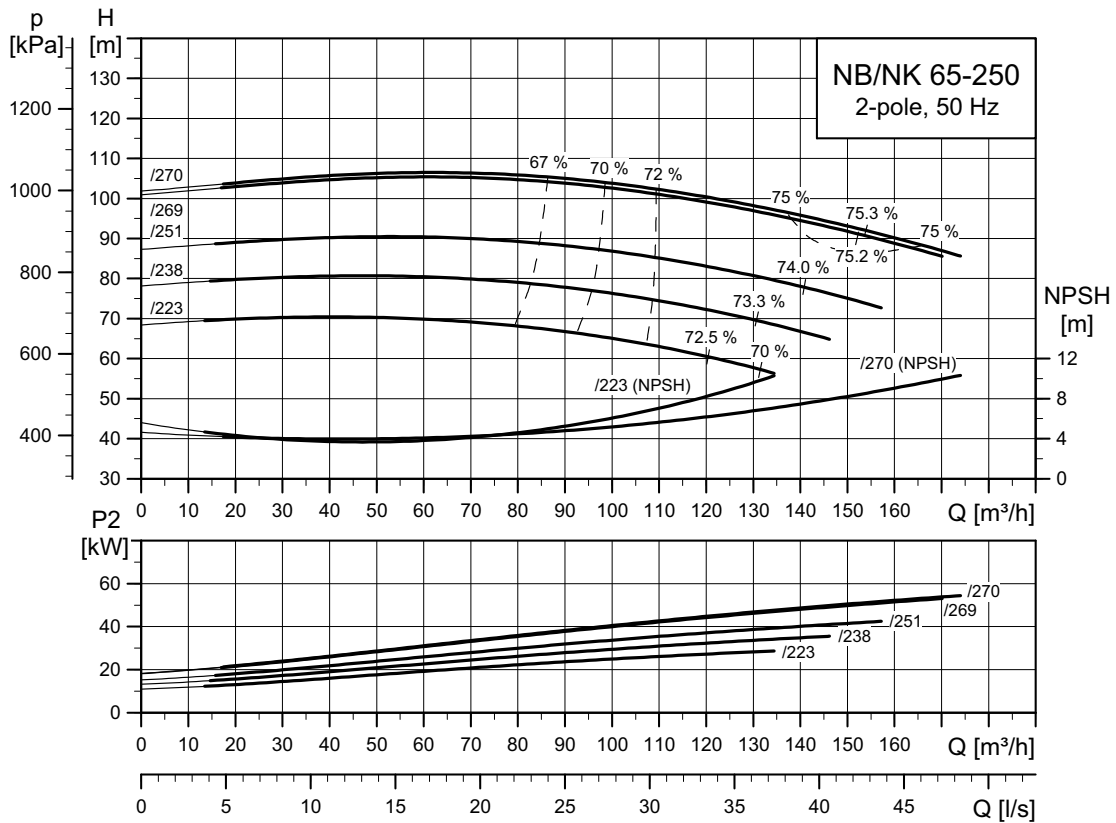

TM03 5101 3414

NB, NK 65-315

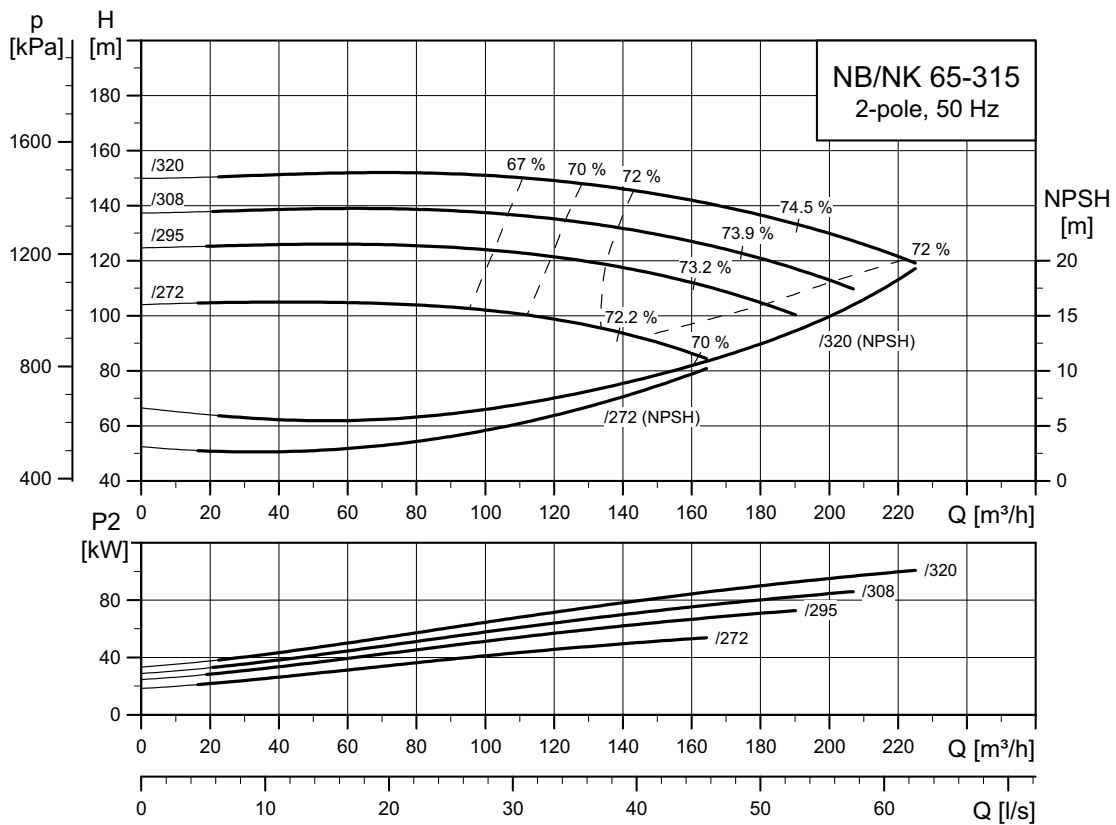

TM03 5102 3414

NB, NK 80-160

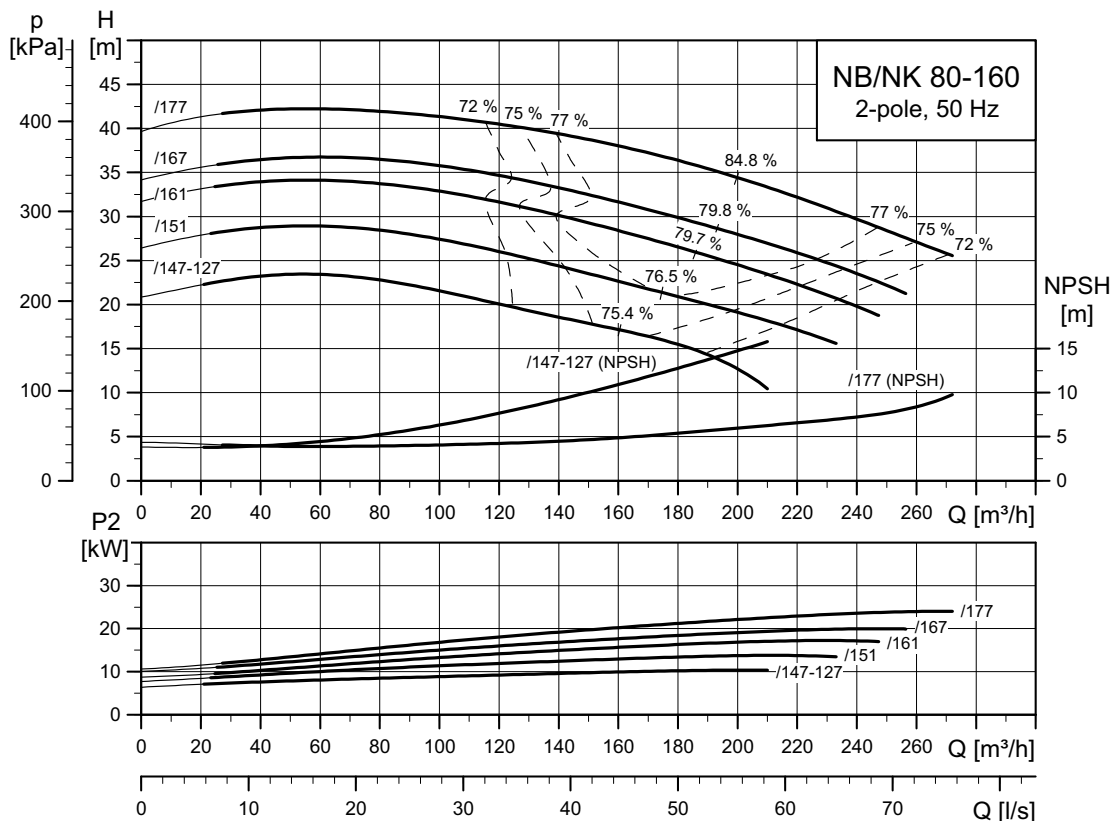

TM03 5103 3414

NB, NK 80-200

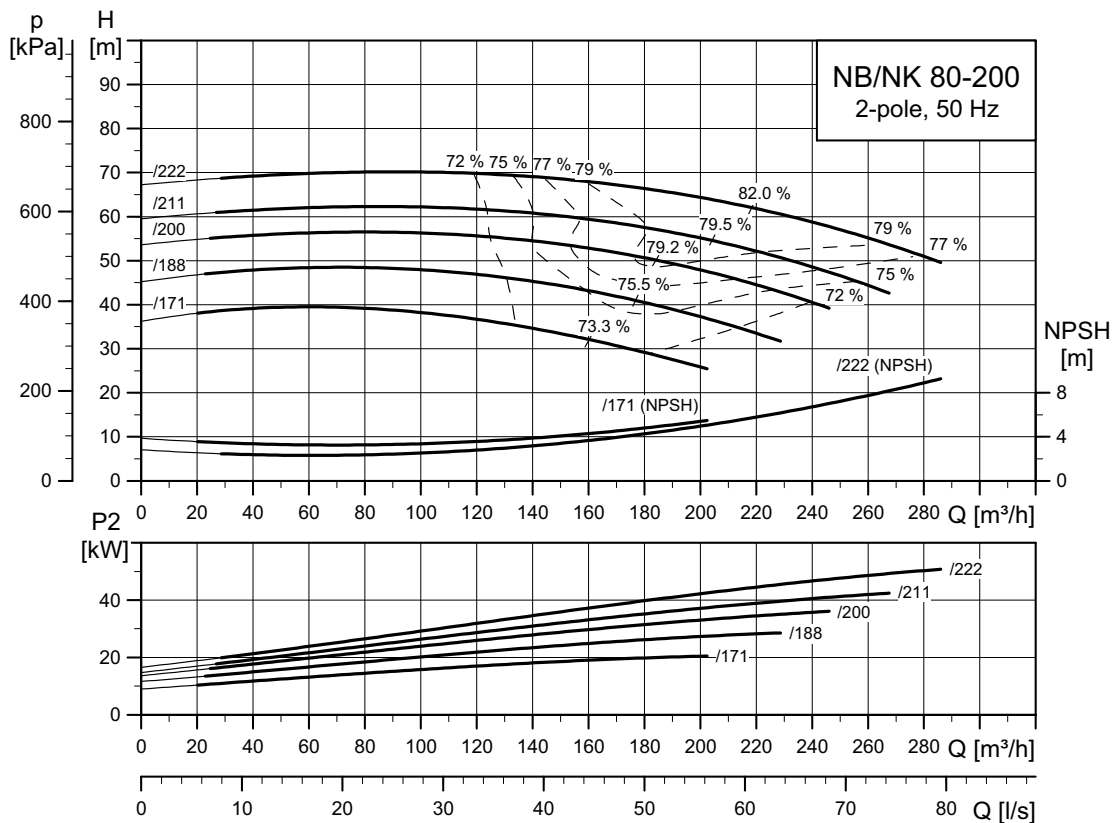

TM03 5104 3414

NB, NK 80-250

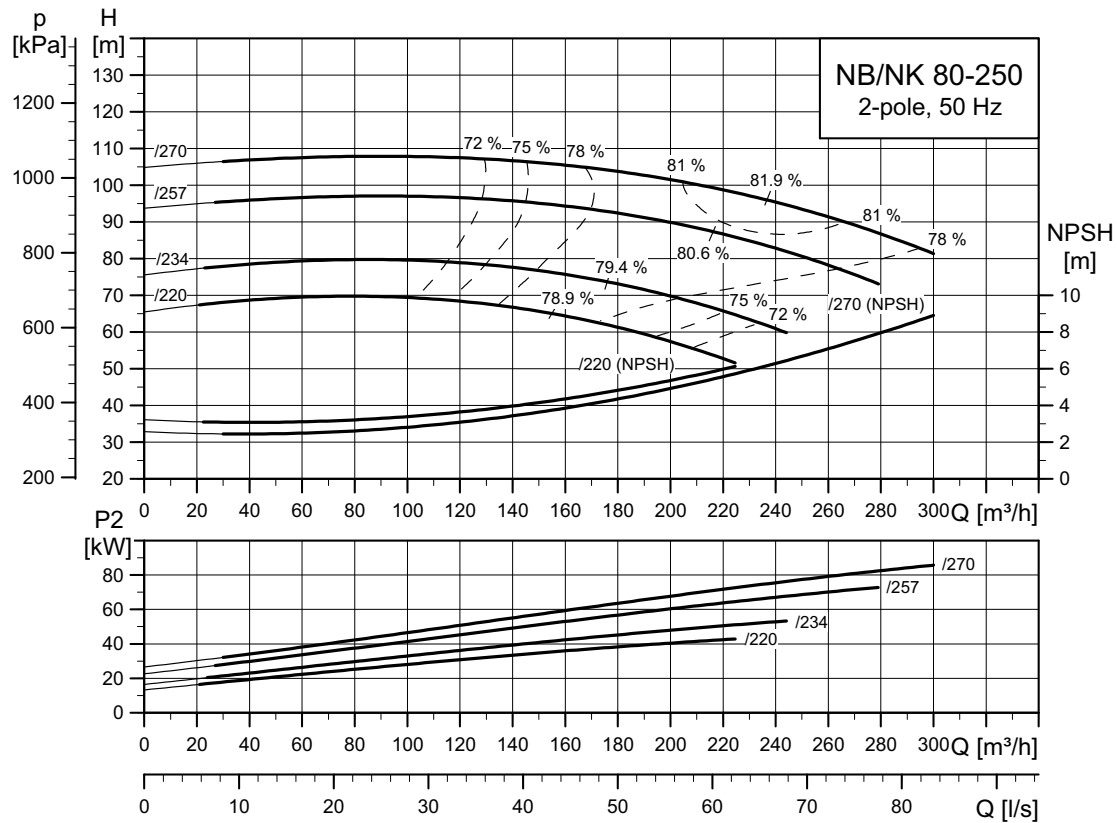

TM03 5105 3414

NB, NK 80-315

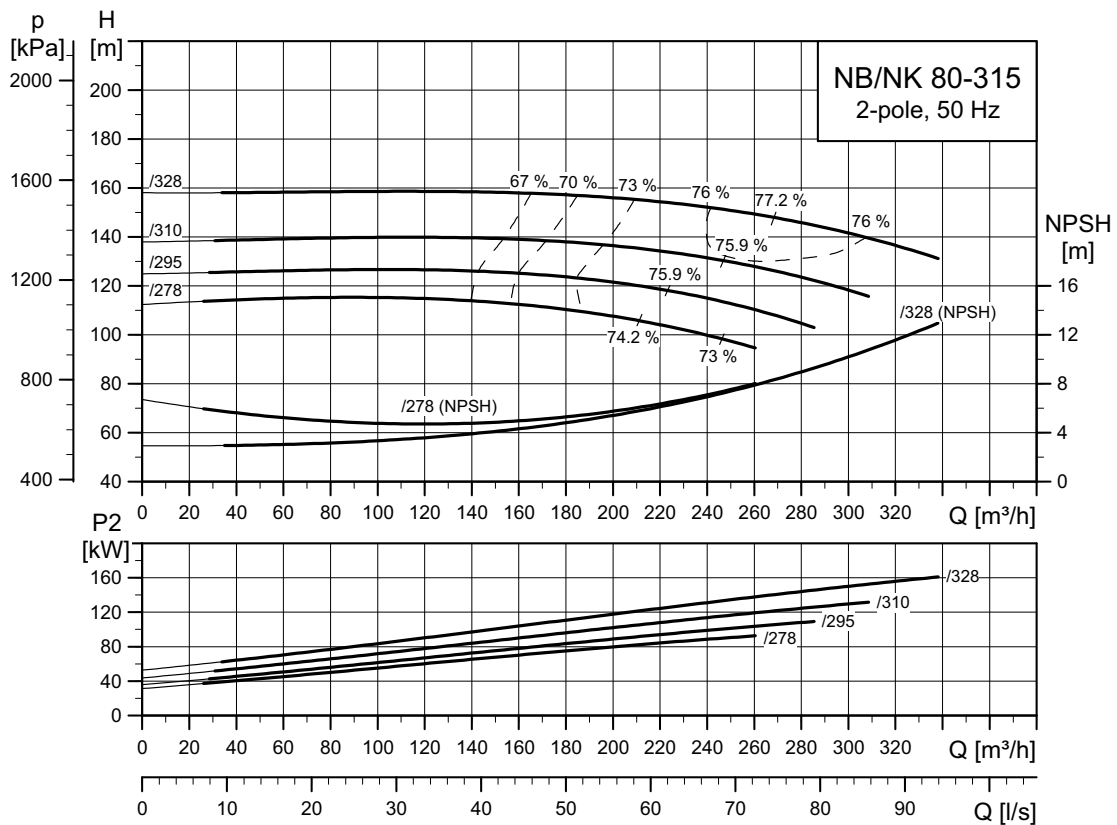

TM03 5106 3414

NB, NK 100-160

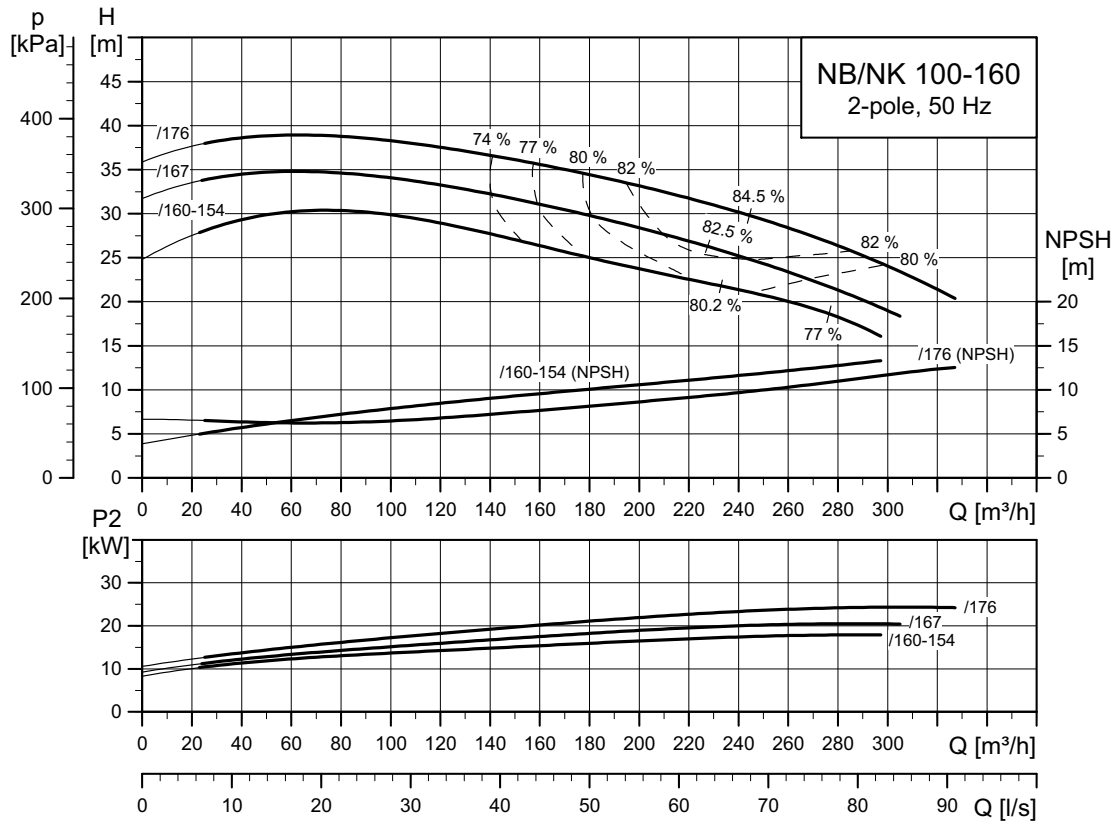

TM03 5107 2715

NB, NK 100-200

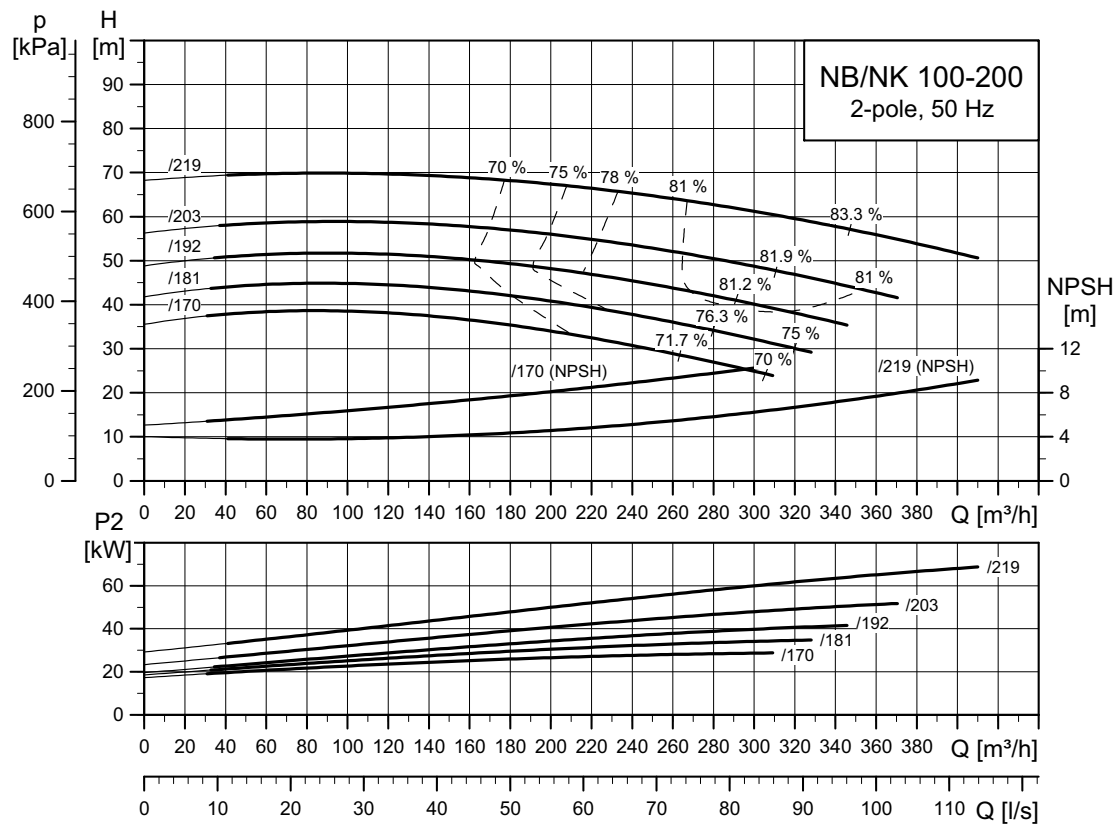

TM03 5108 3414

NB, NK 100-250

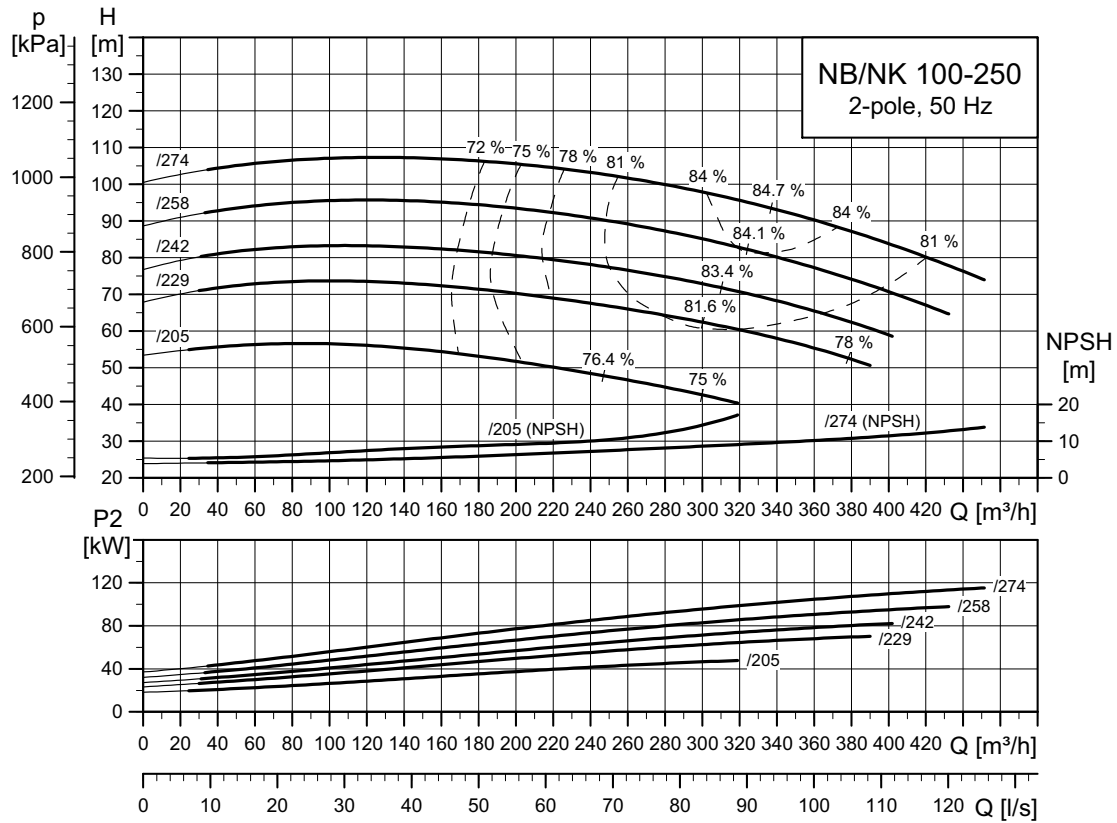

TM03 5109 4115

NB, NK 100-315

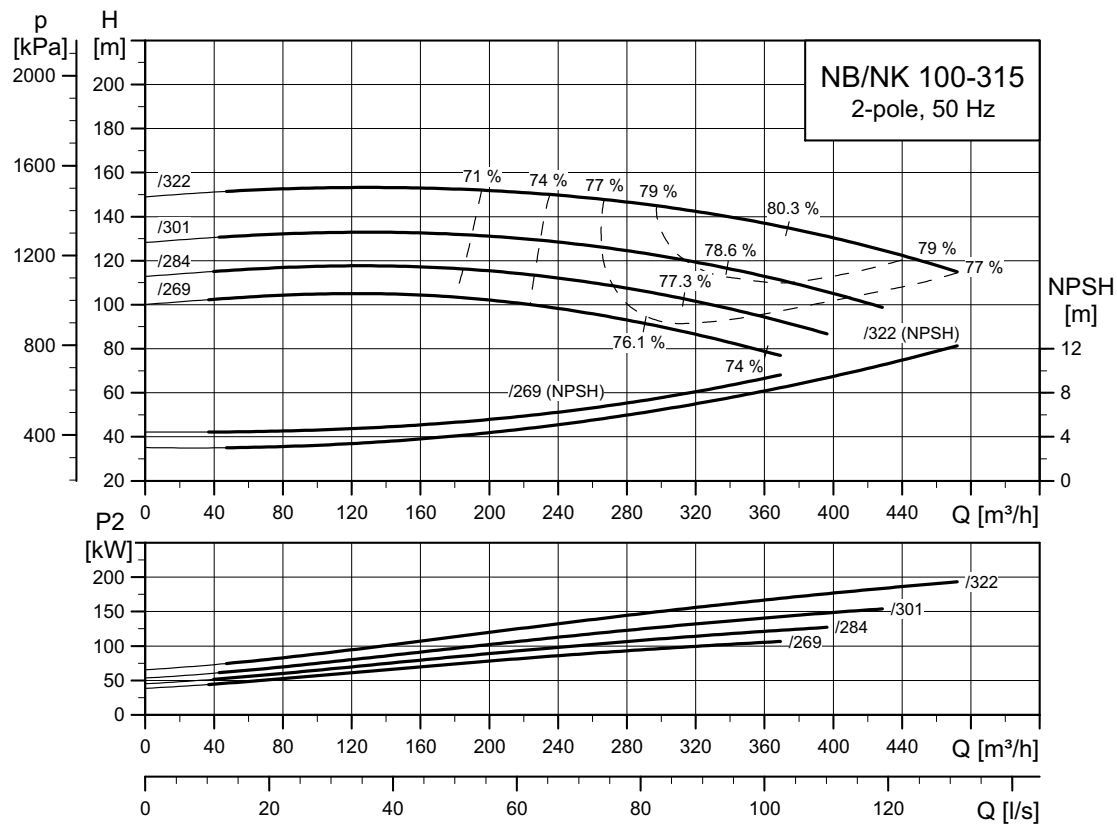

TM03 5110 3414

NB, NK 125-200

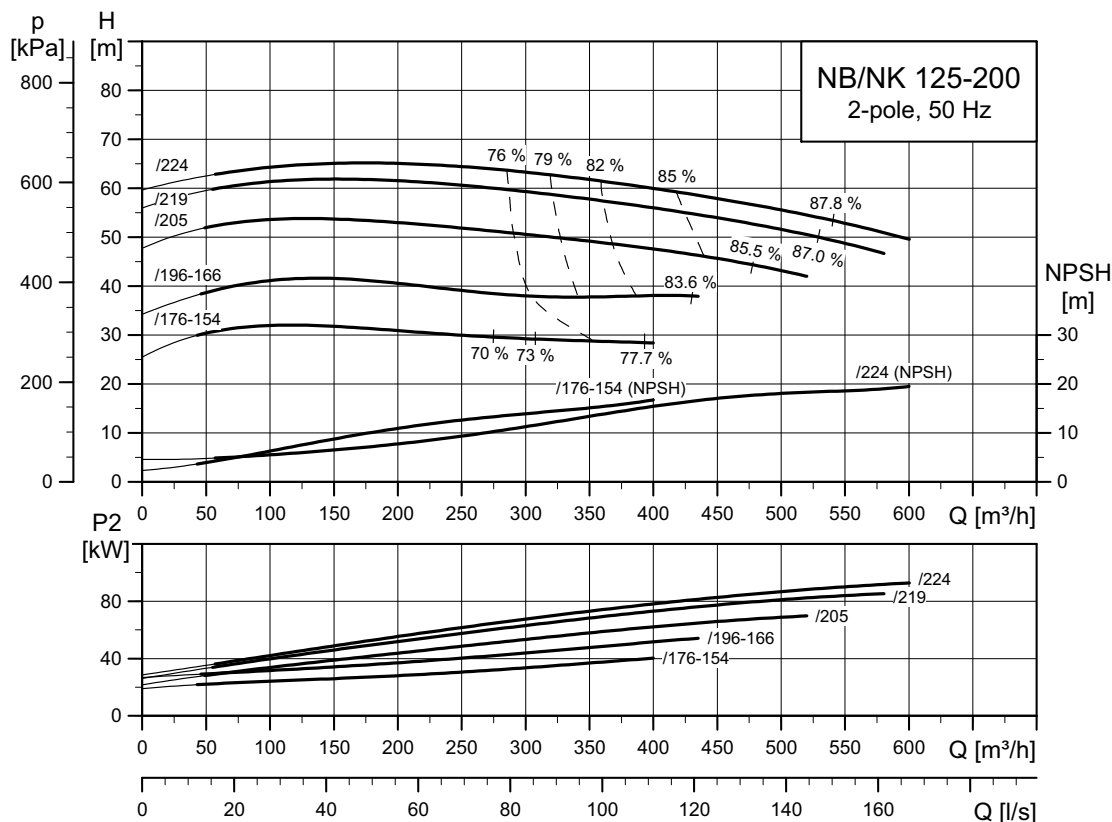

TM03 5111 2715

NB, NK 125-250

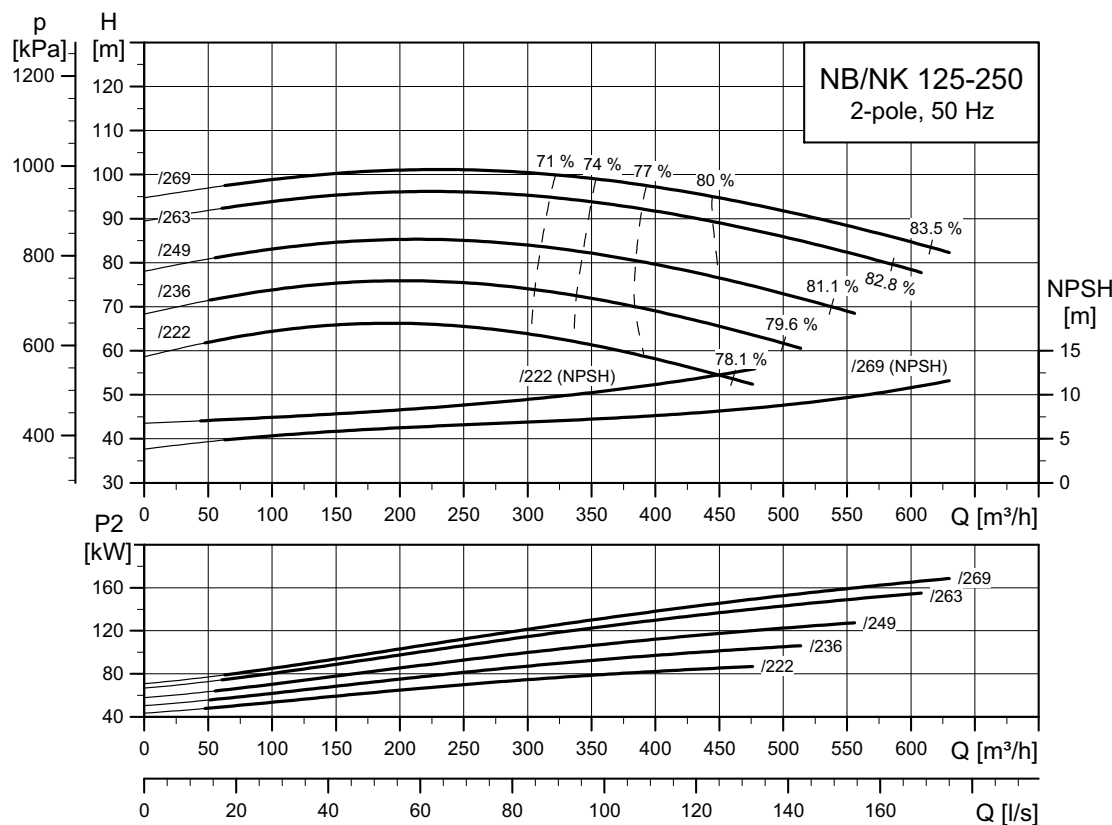

TM03 5112 3414

NB, NK 125-315

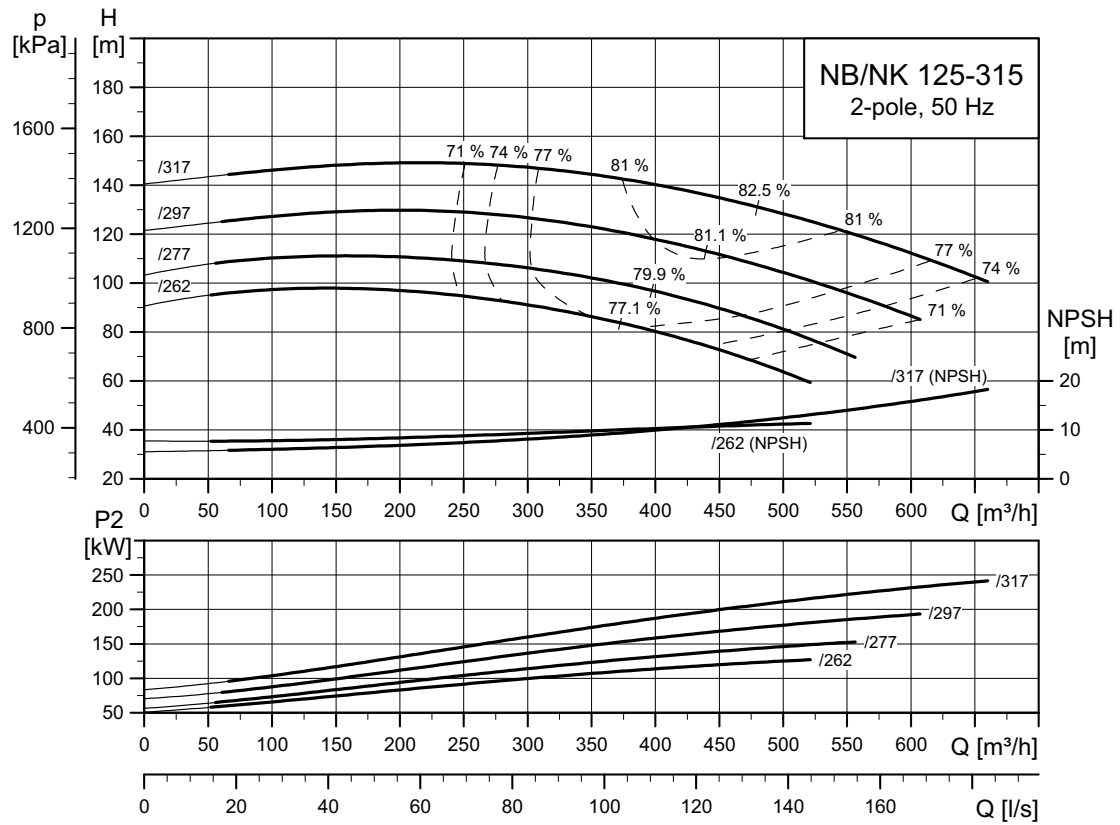

TM03 5113 3414

NB, NK 150-200

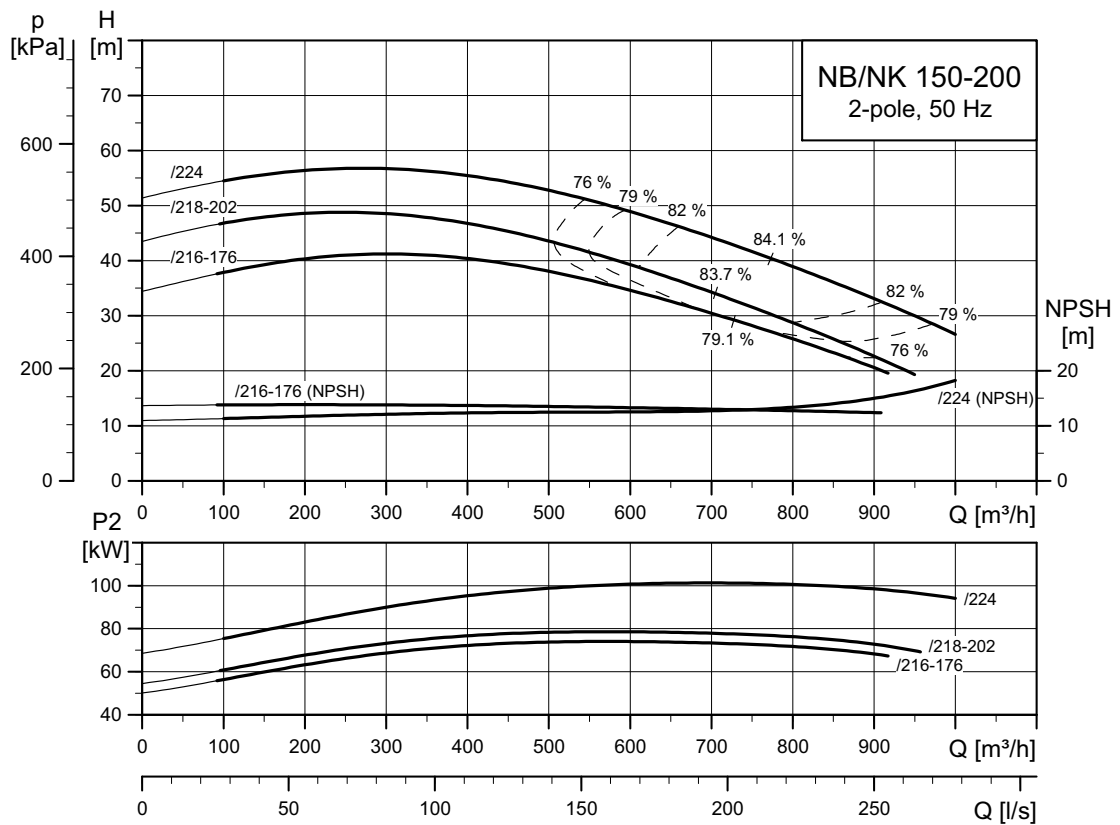

TM03 5114 3414

NB, NK 150-250

NB, NK 150-315.2

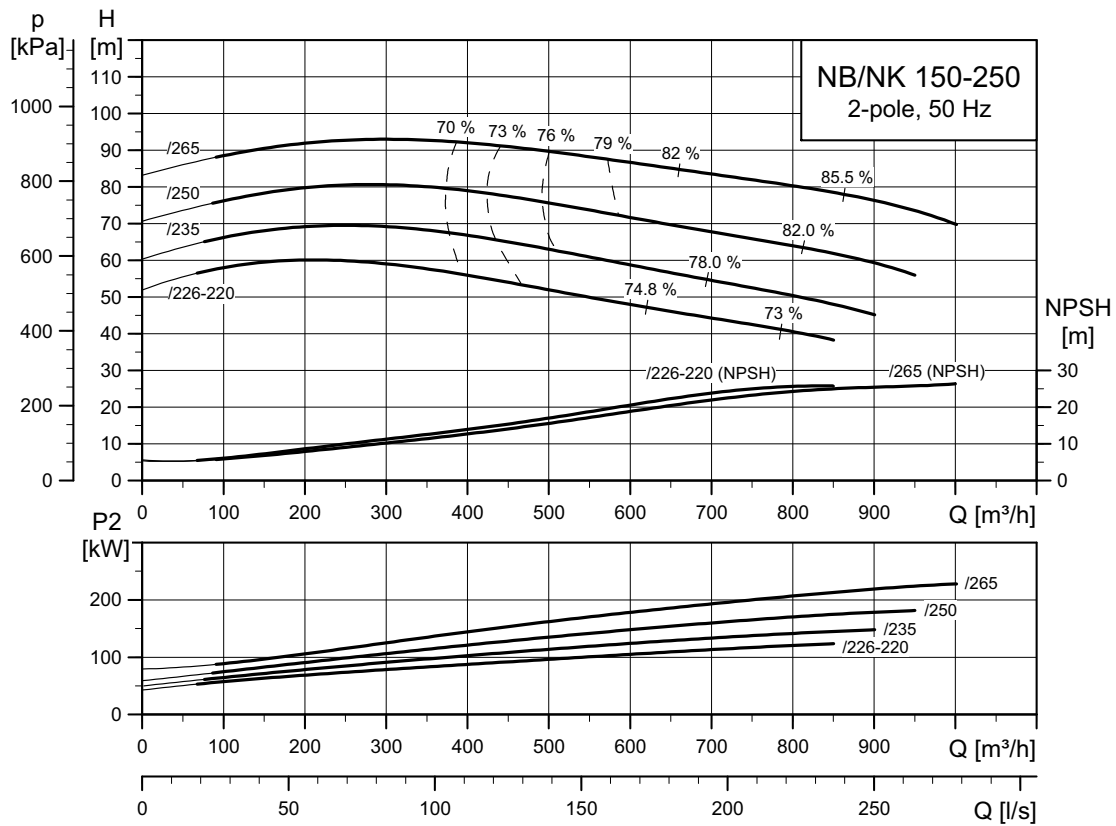

TM03 5115 3414

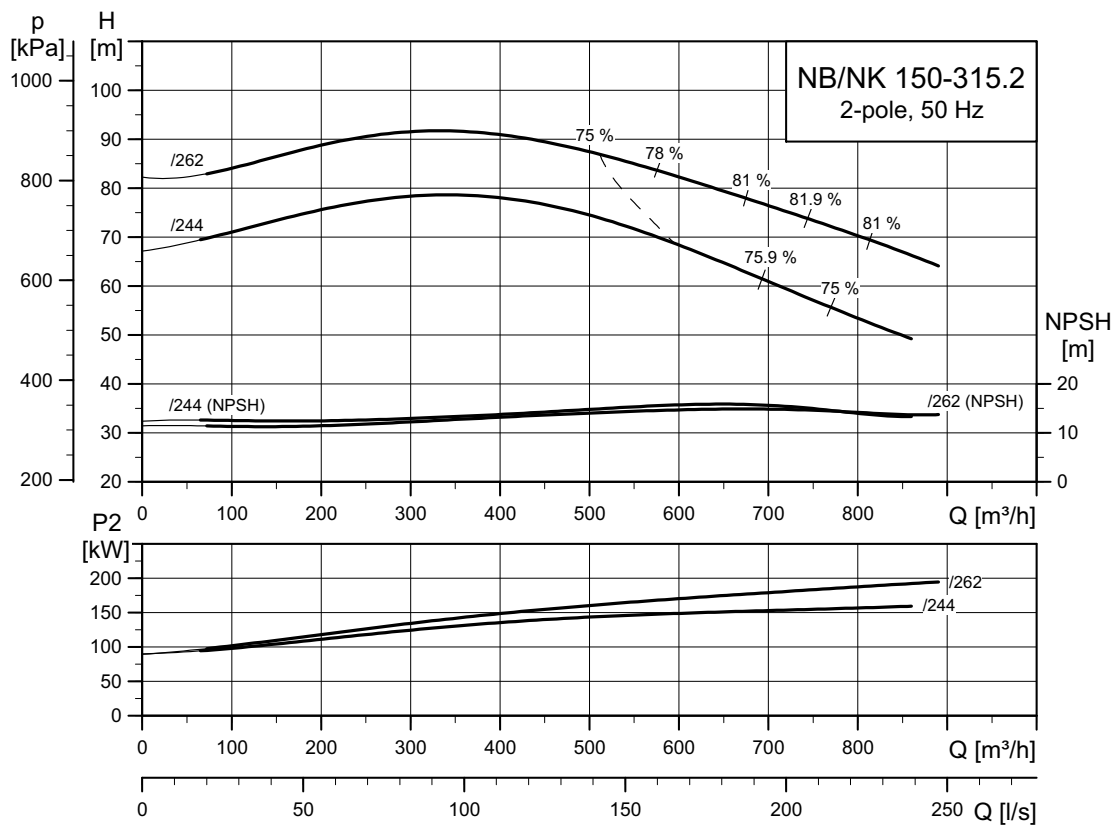

TM06 4750 3315

4-pole

NB, NK 32-125.1

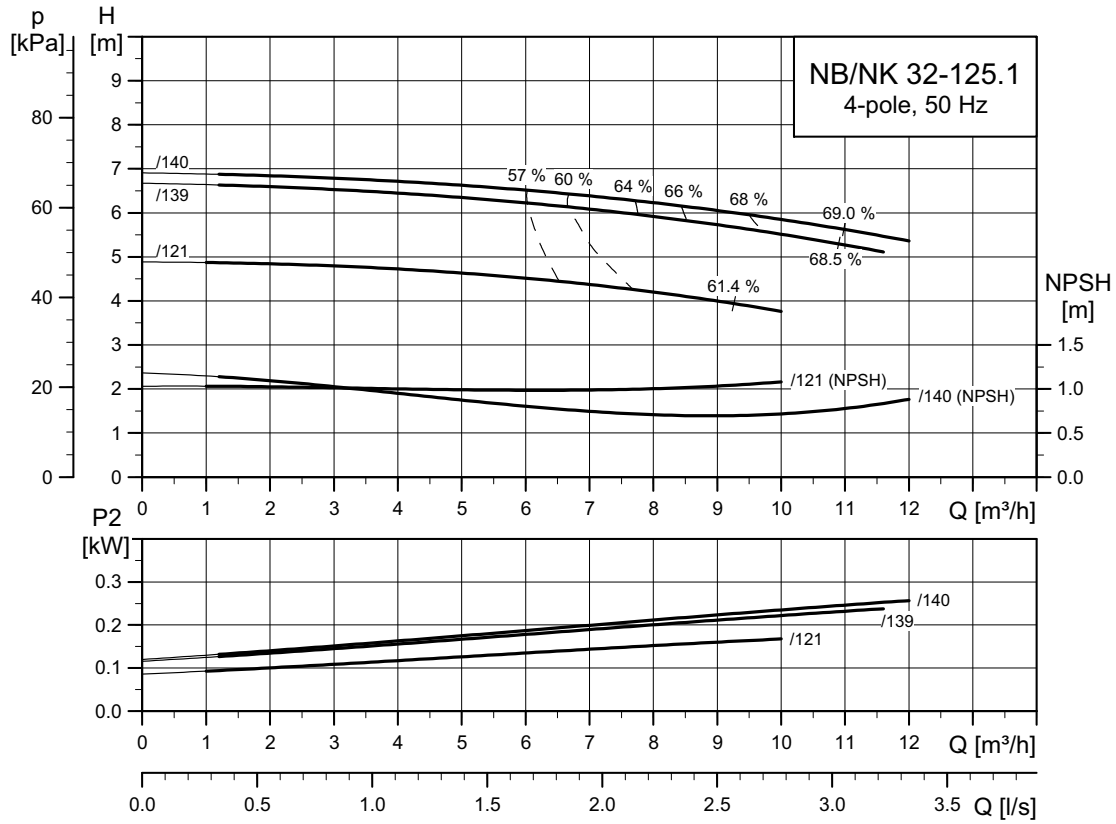

TM03 5117 3414

NB, NK 32-125

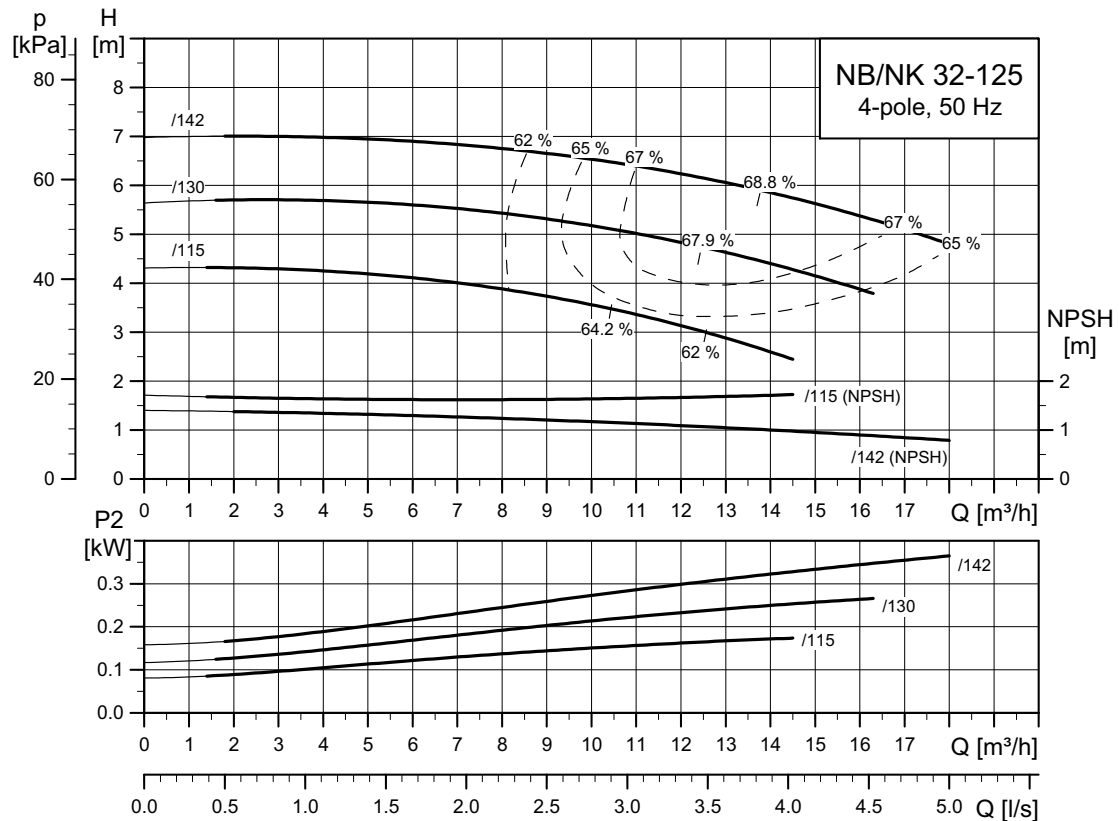

TM03 5120 3414

NB, NK 32-160.1

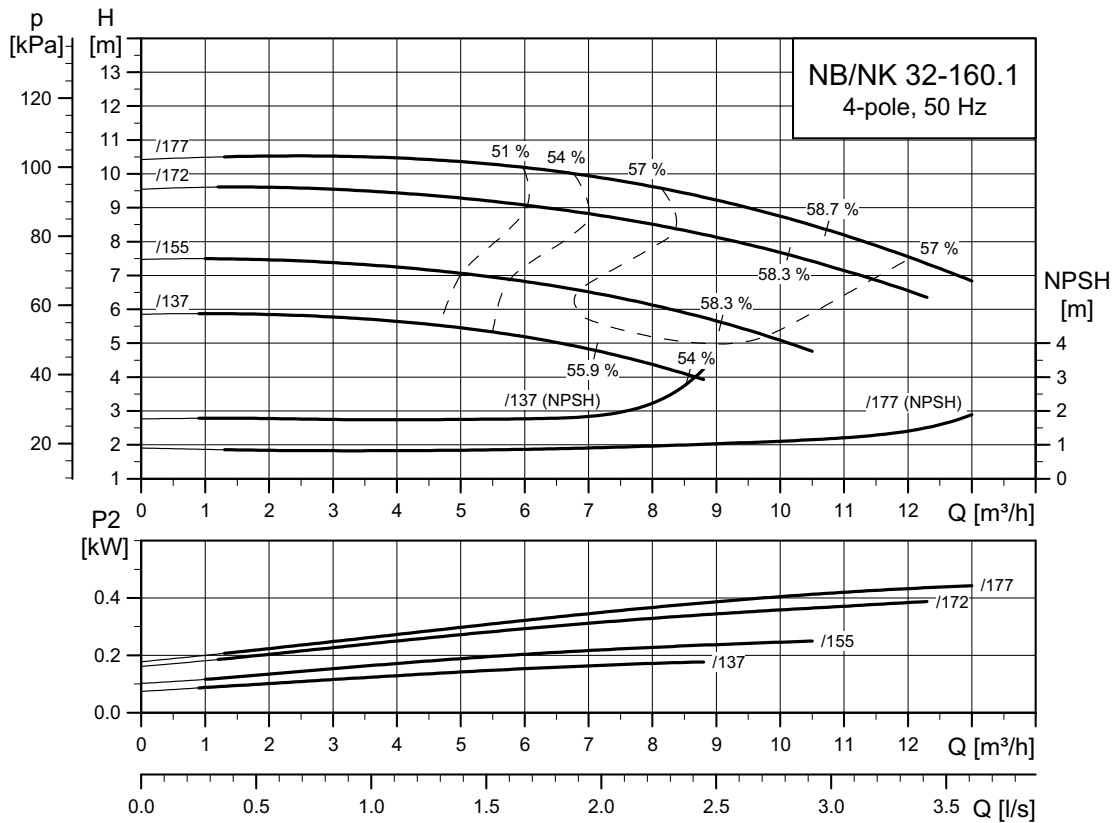

TM03 5118 3414

NB, NK 32-160

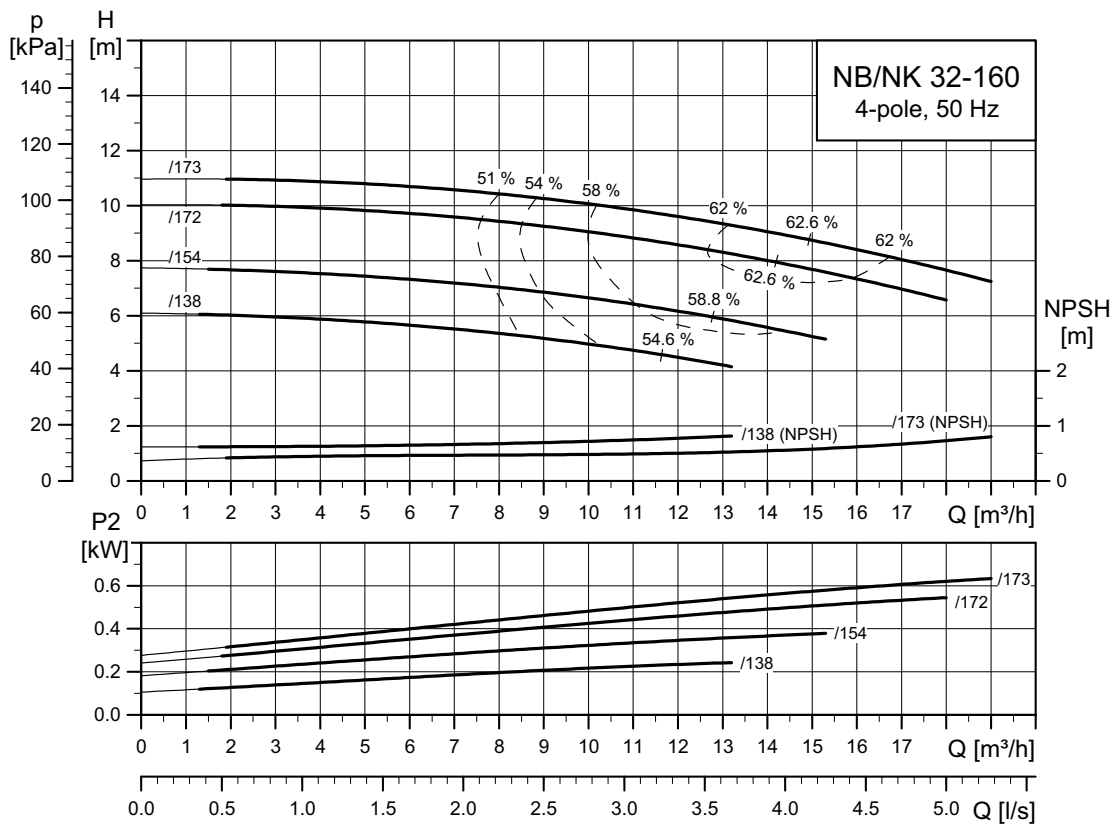

TM03 5121 3414

NB, NK 32-200.1

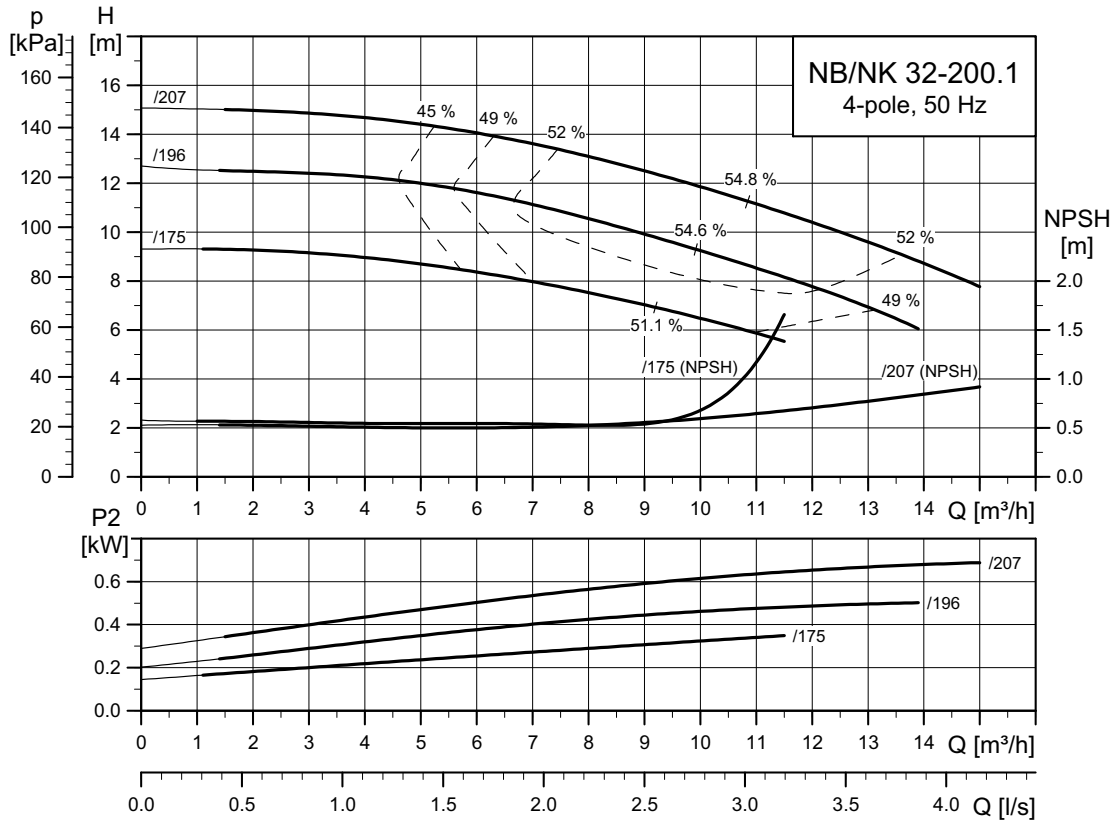

TM03 5119 3414

NB, NK 32-200

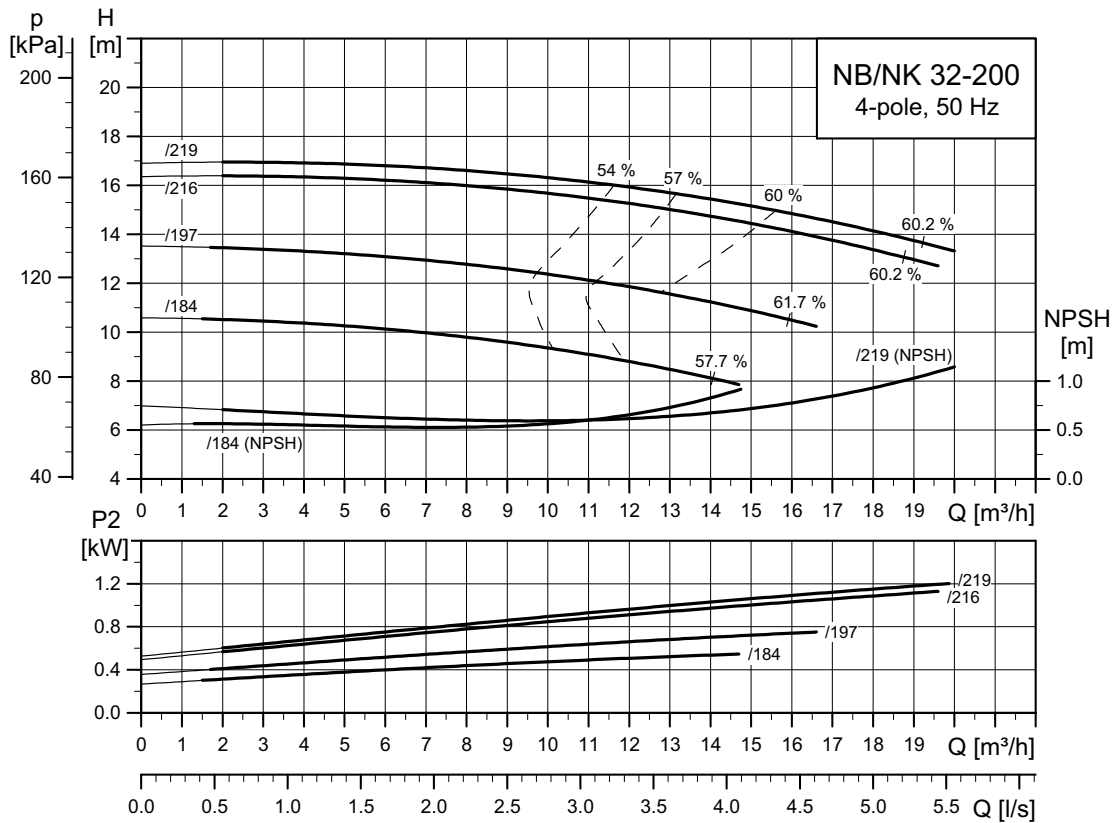

TM03 5122 3414

NB, NK 32-250

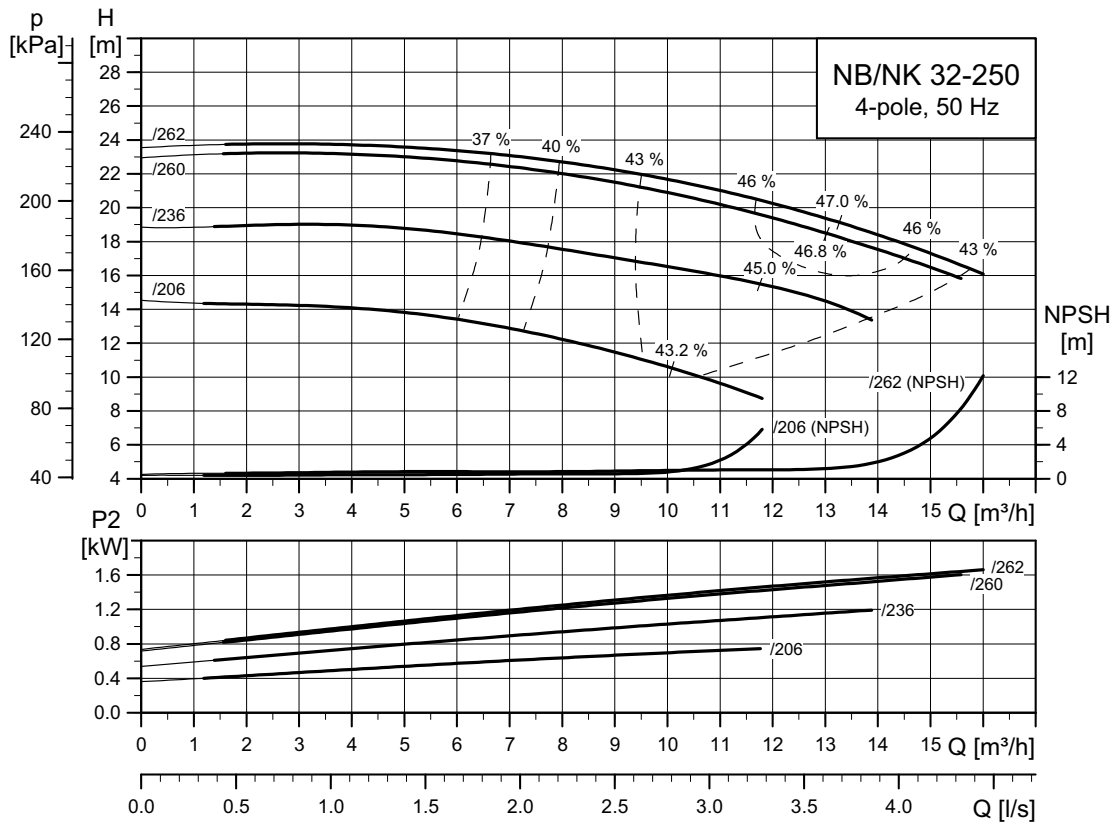

TM03 5123 3414

NB, NK 40-125

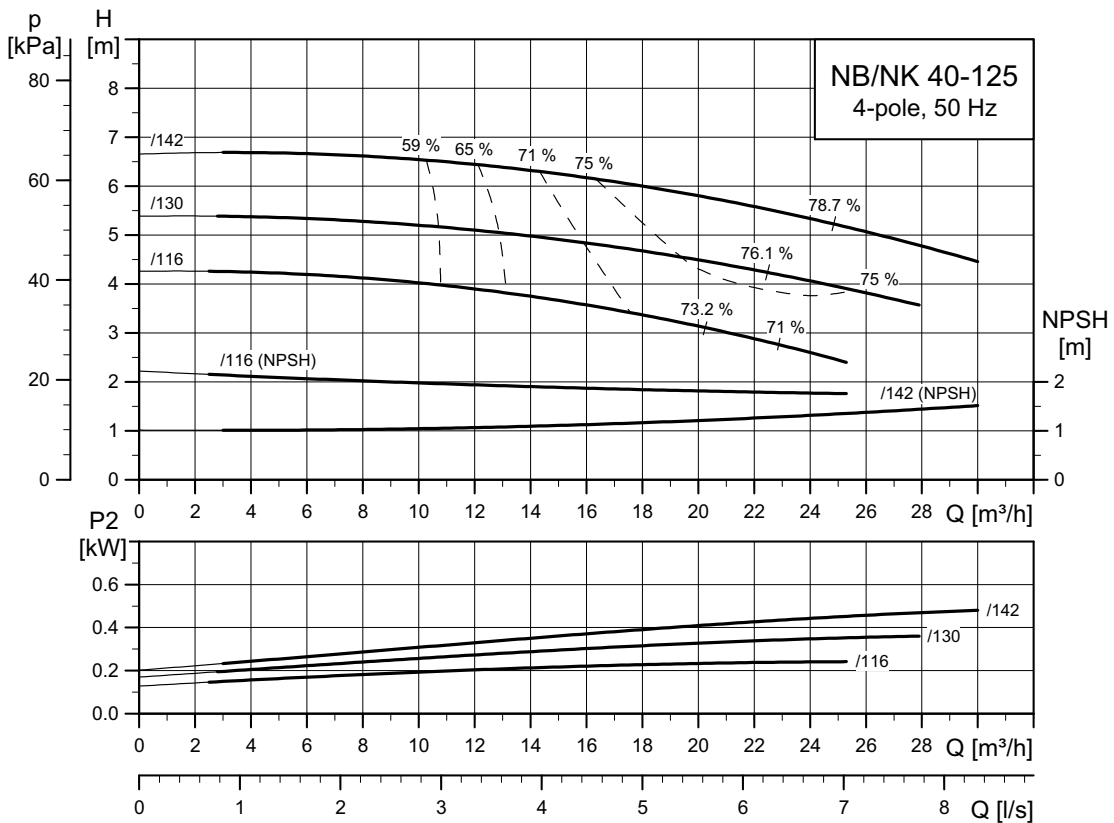

TM03 5124 3414

NB, NK 40-160

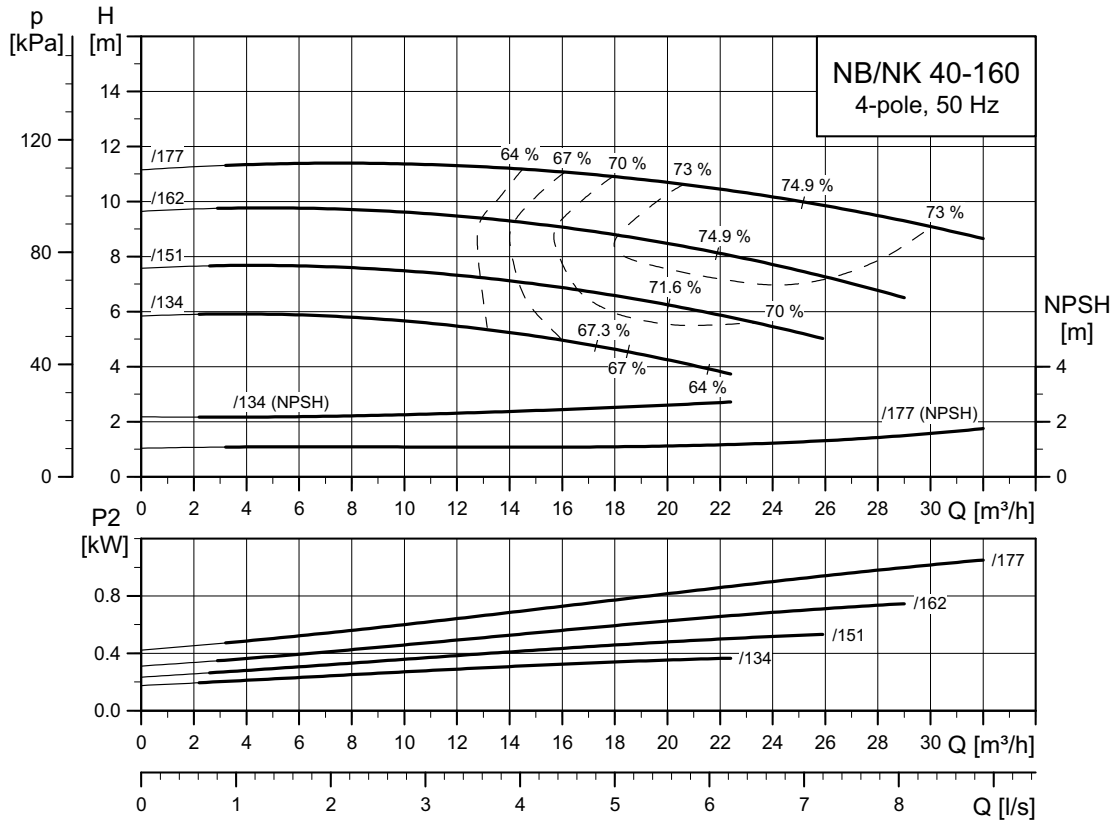

TM03 5125 3414

NB, NK 40-200

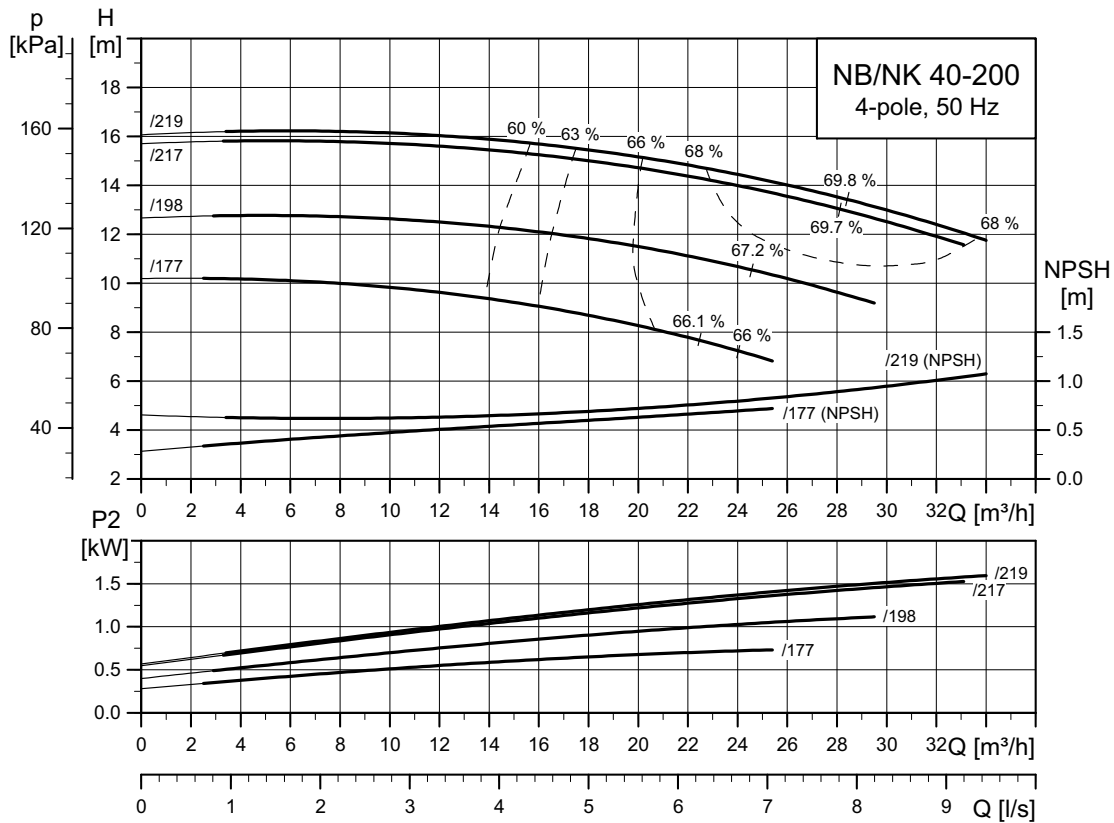

TM03 5126 3414

NB, NK 40-250

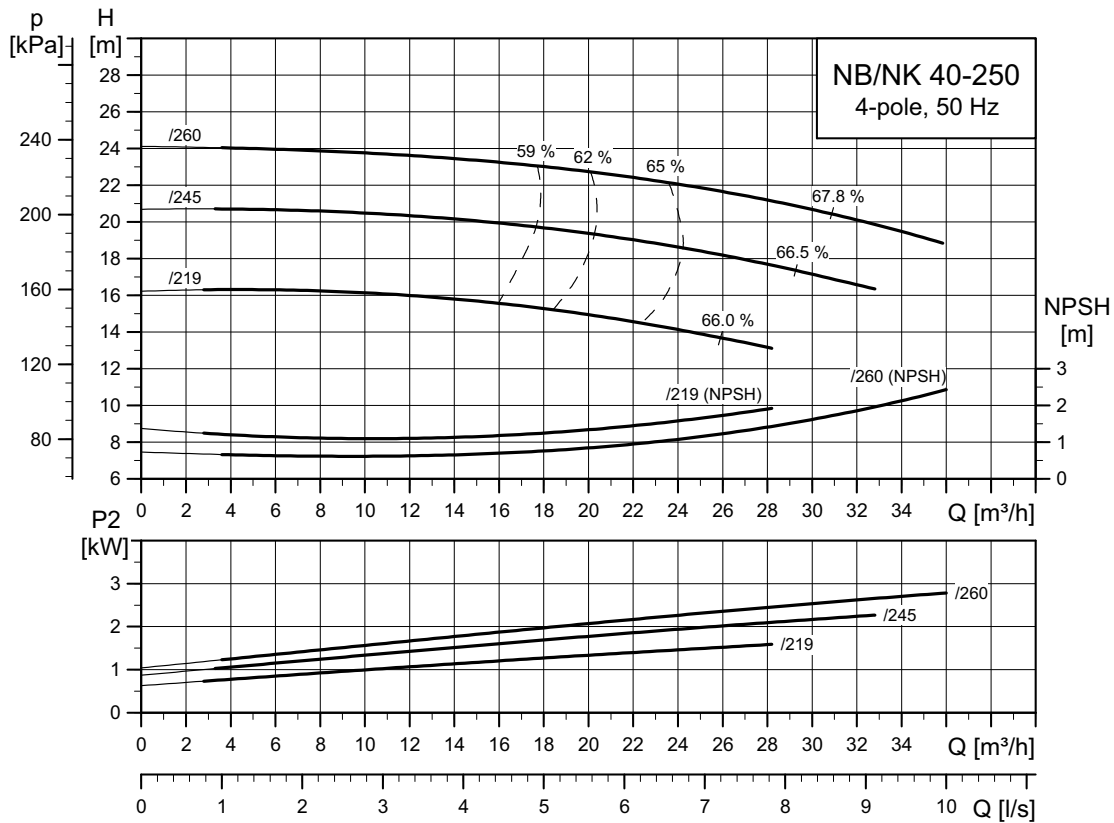

TM03 5127 3414

NB, NK 40-315

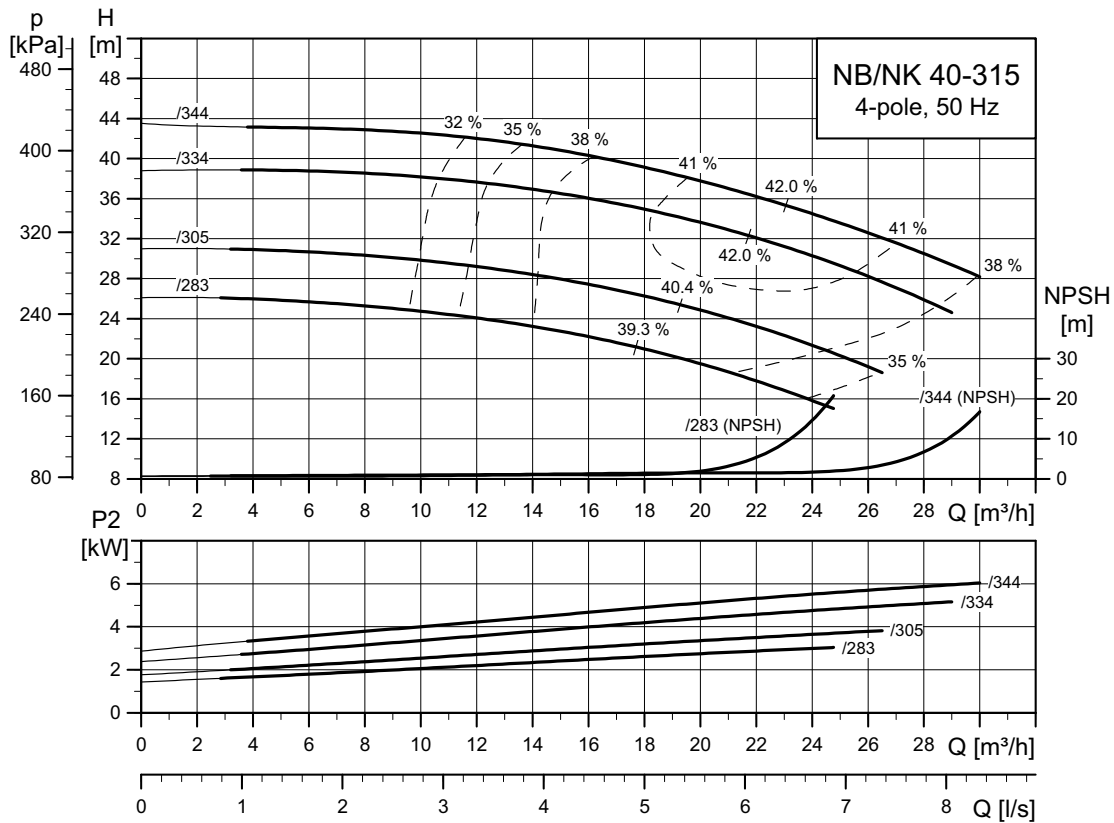

TM03 5128 3414

NB, NK 50-125

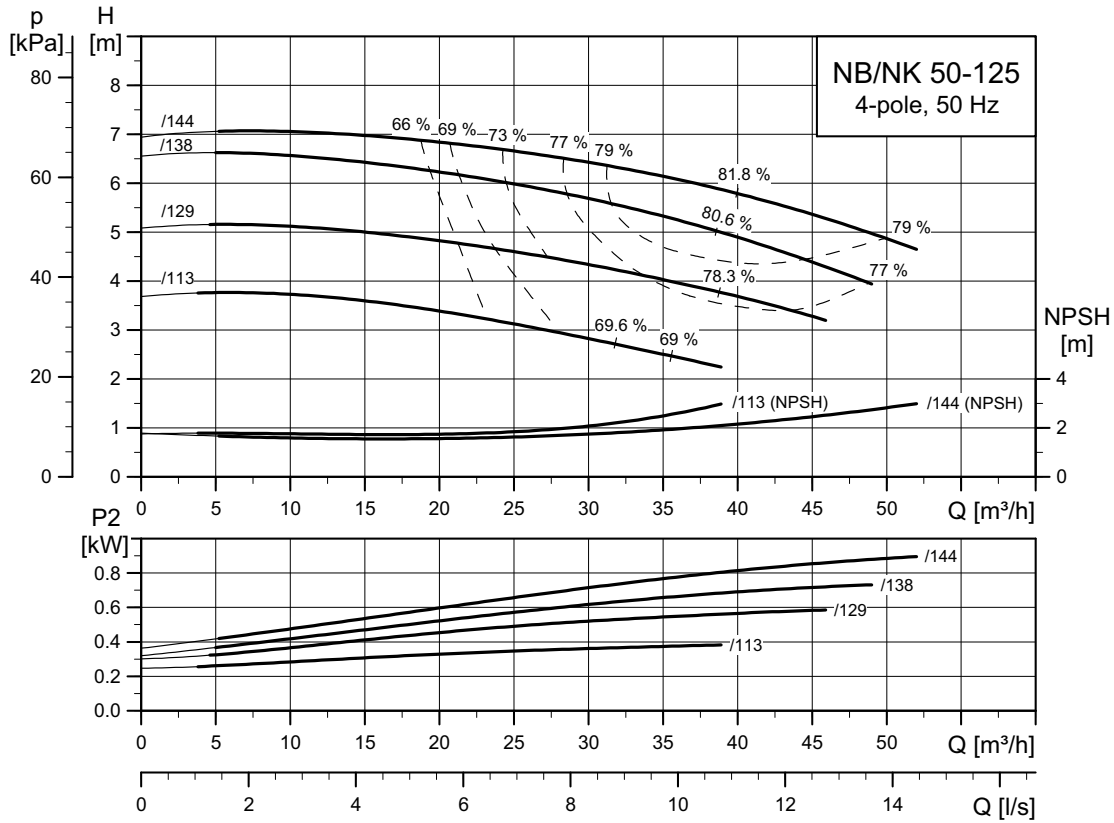

TM03 5129 3414

NB, NK 50-160

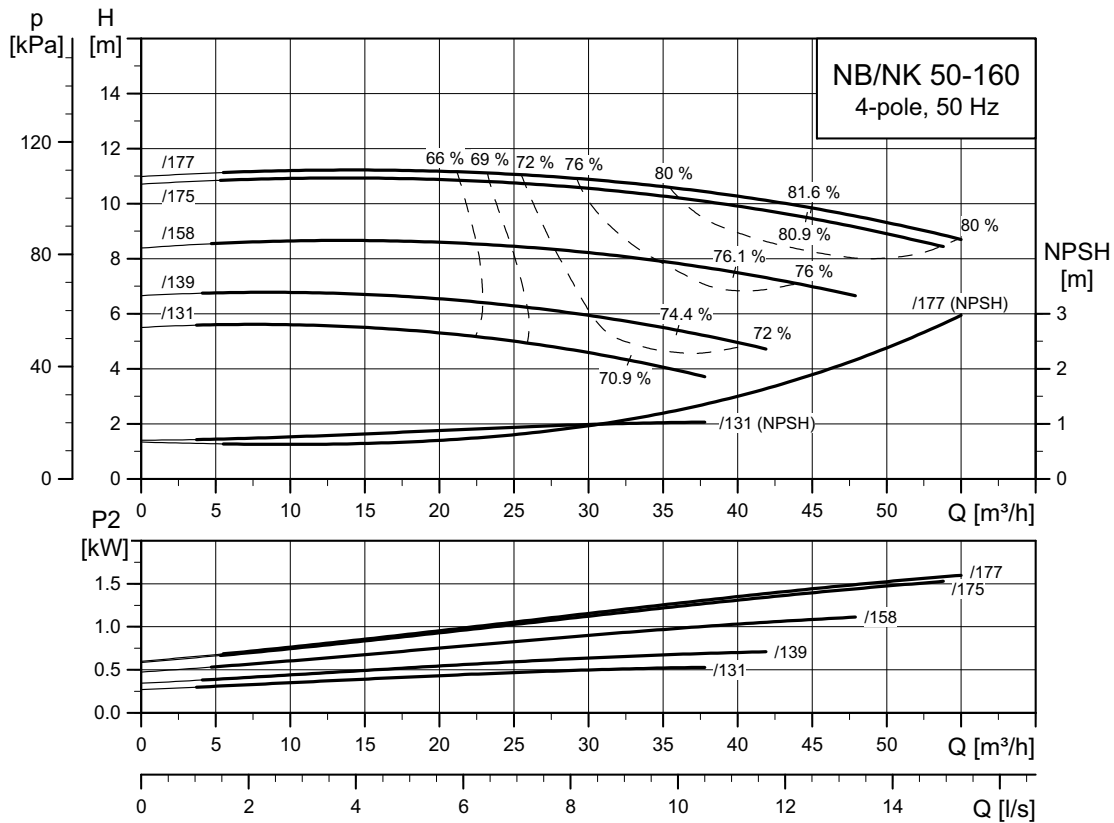

TM03 5130 3414

NB, NK 50-200

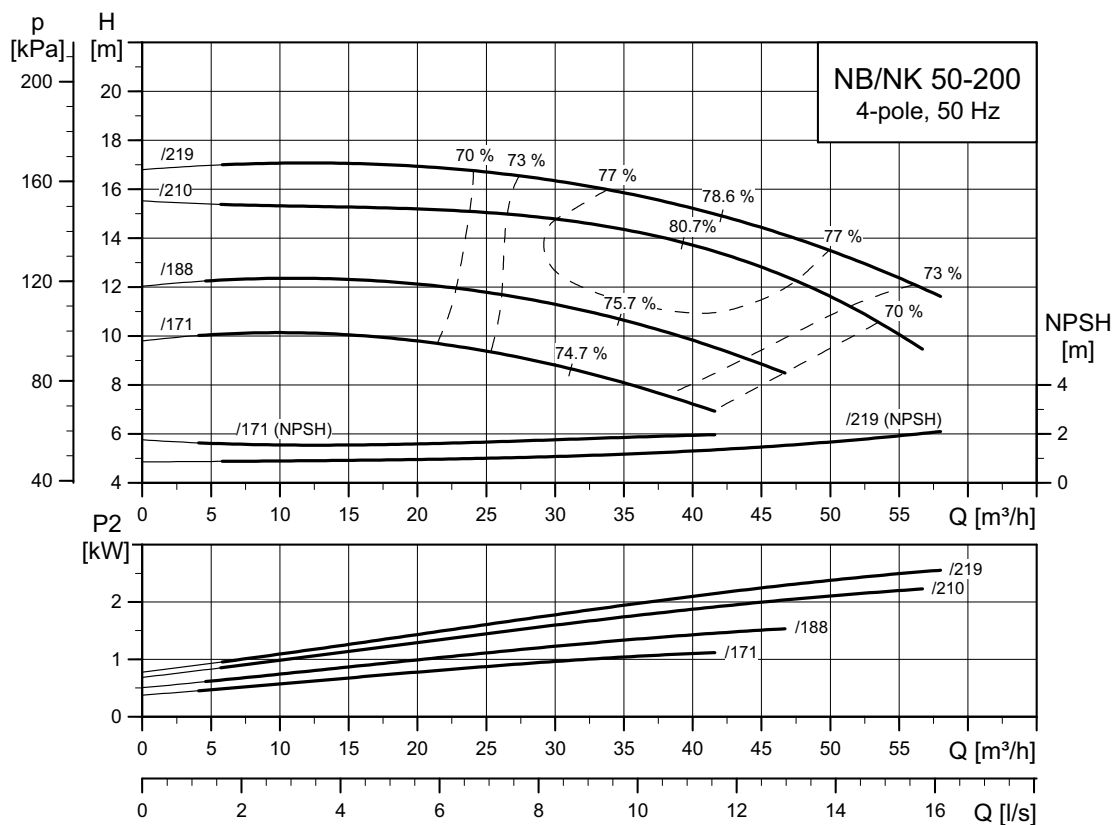

TM03 5131 3414

NB, NK 50-250

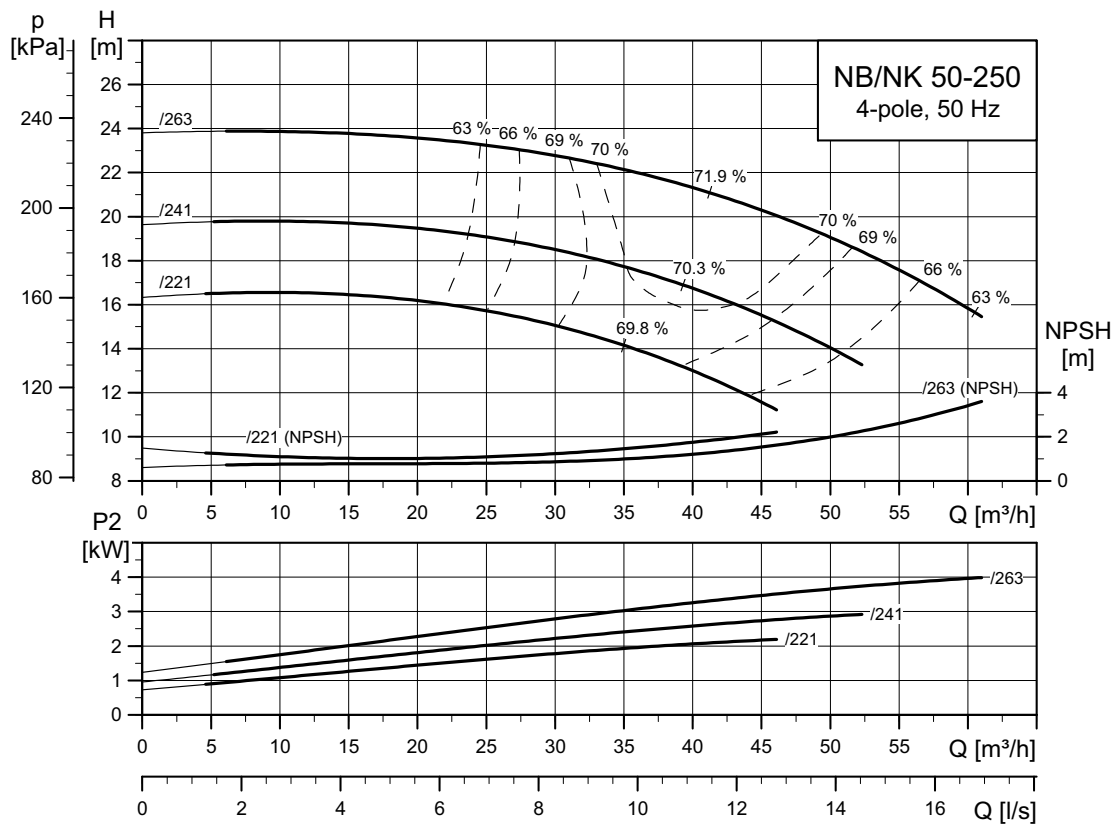

TM03 5132 3414

NB, NK 50-315

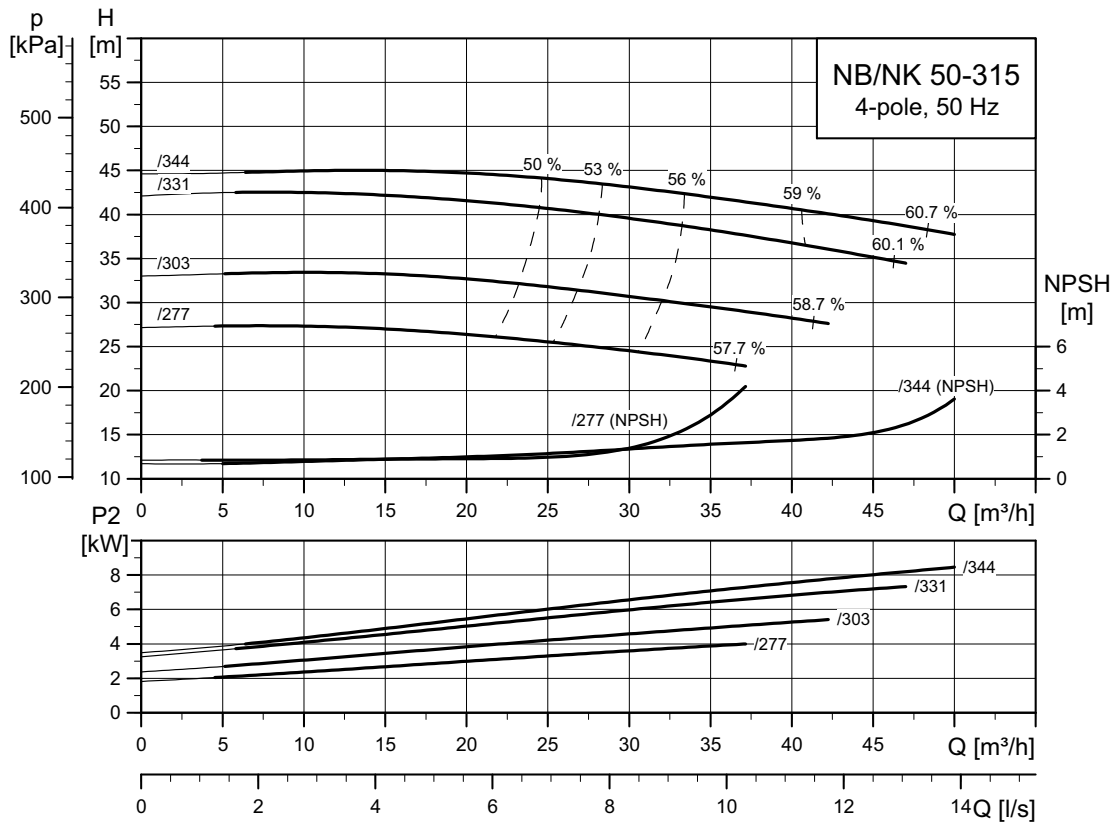

TM03 5133 3414

NB, NK 65-125

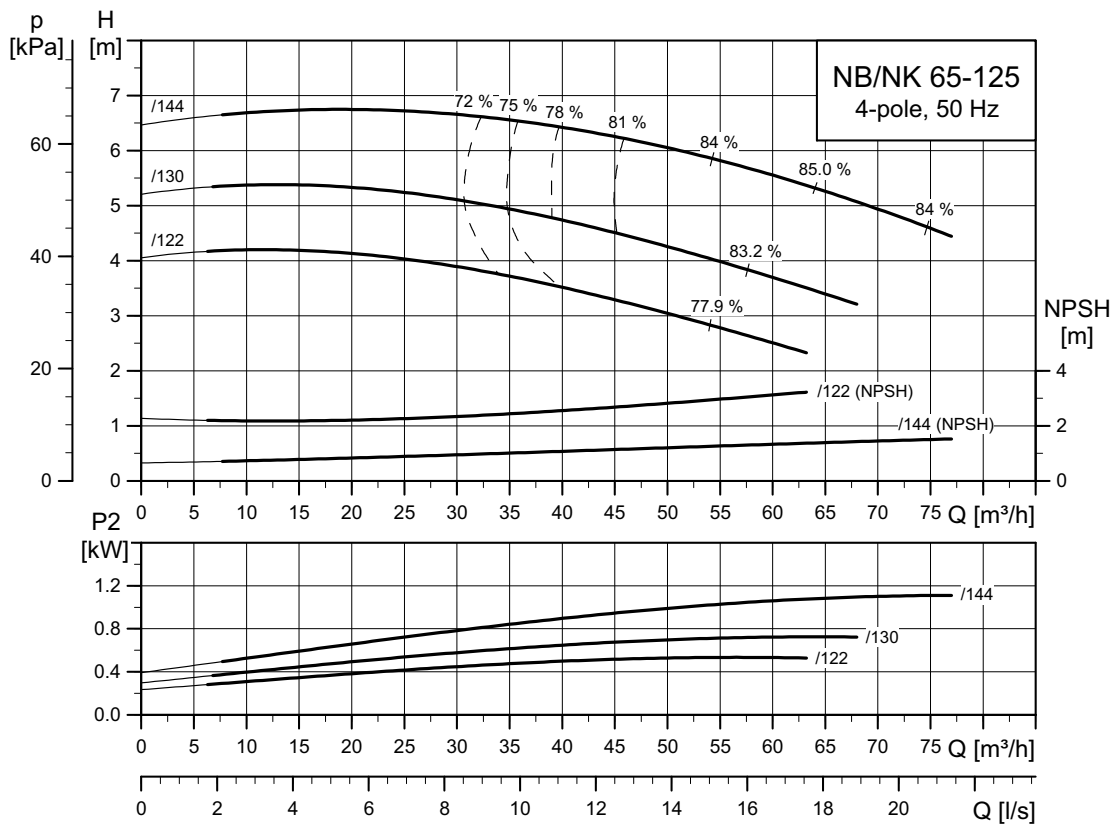

TM03 5134 3414

NB, NK 65-160

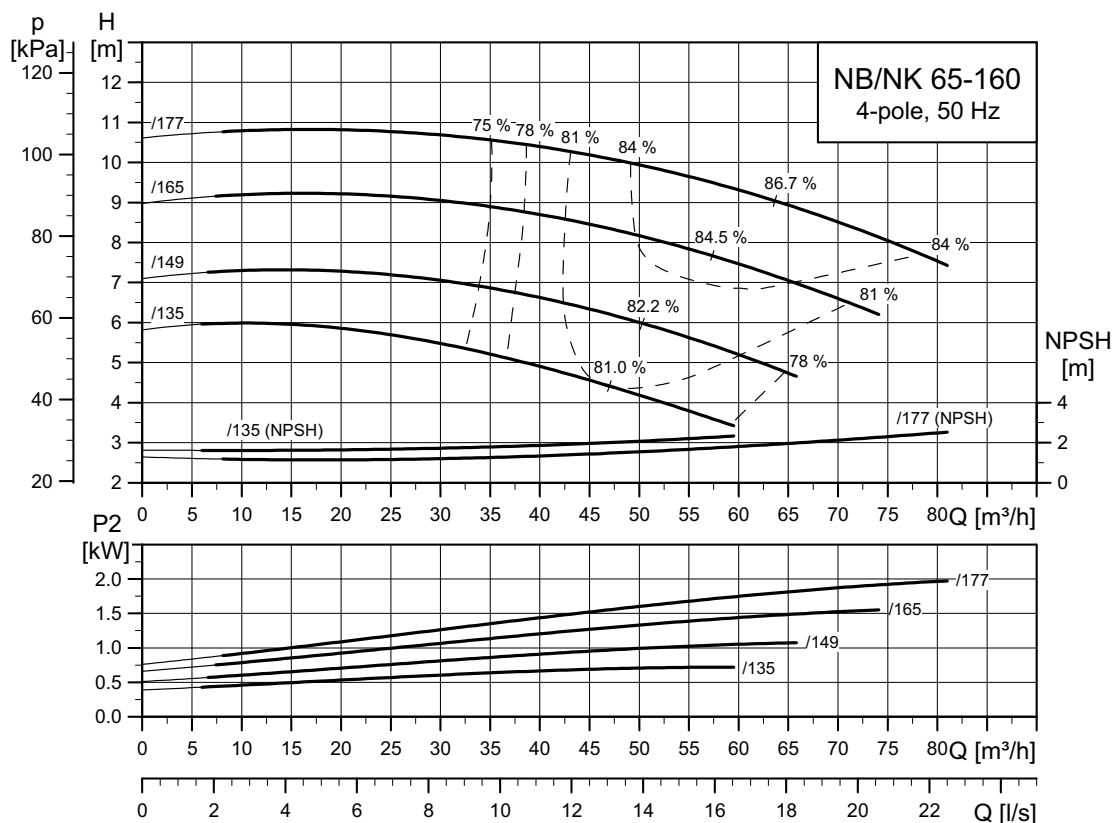

TM03 5135 3414

NB, NK 65-200

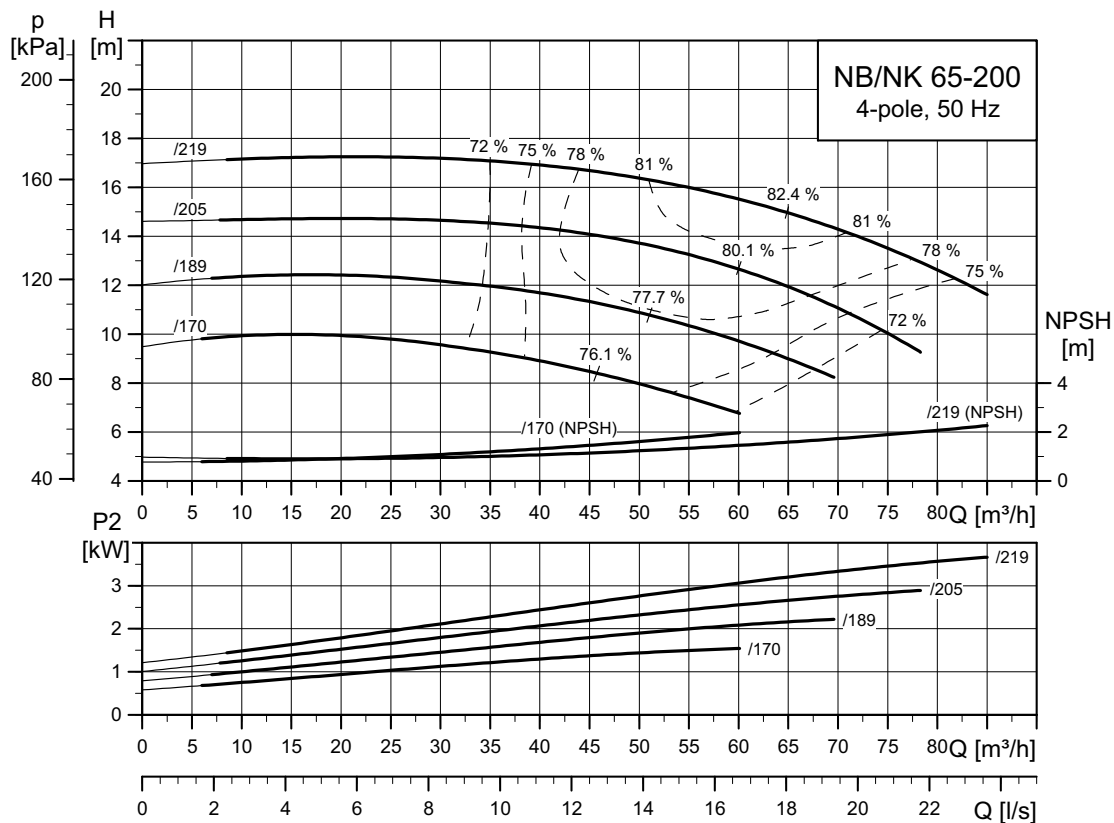

TM03 5136 3414

NB, NK 65-250

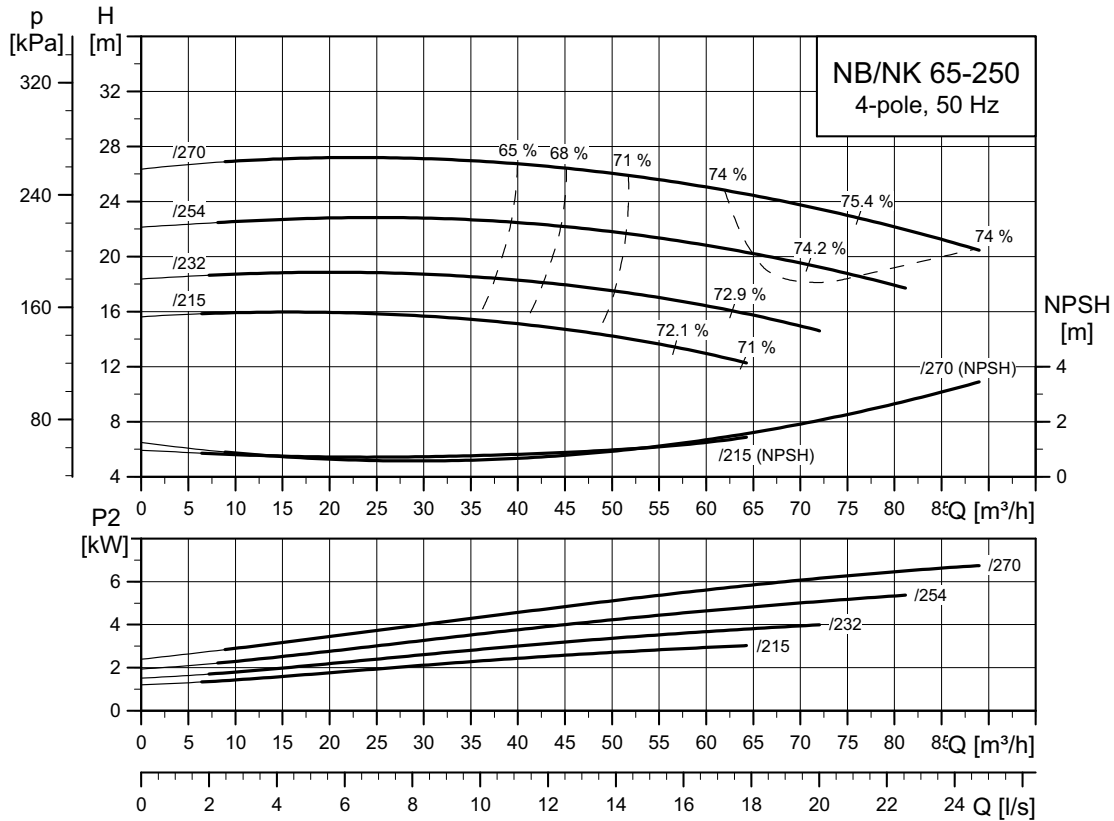

TM03 5137 3414

NB, NK 65-315

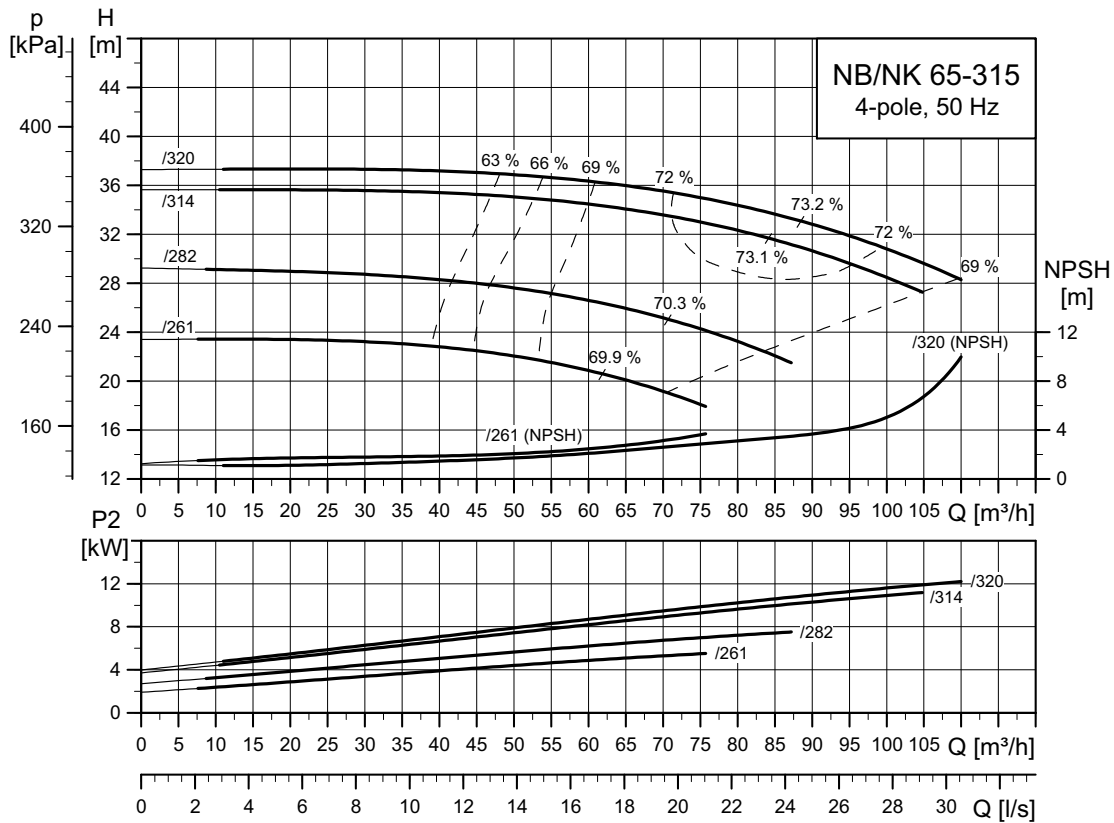

TM03 5138 3414

NB, NK 80-160

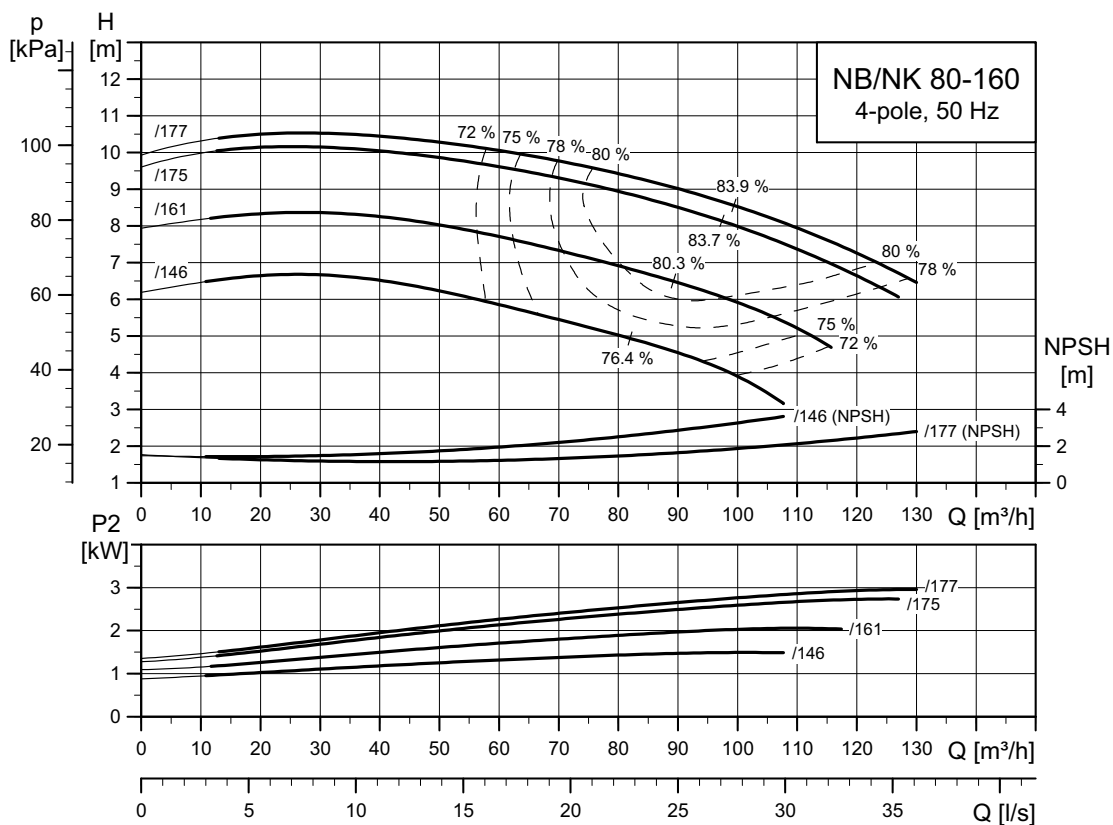

TM03 5139 3414

NB, NK 80-200

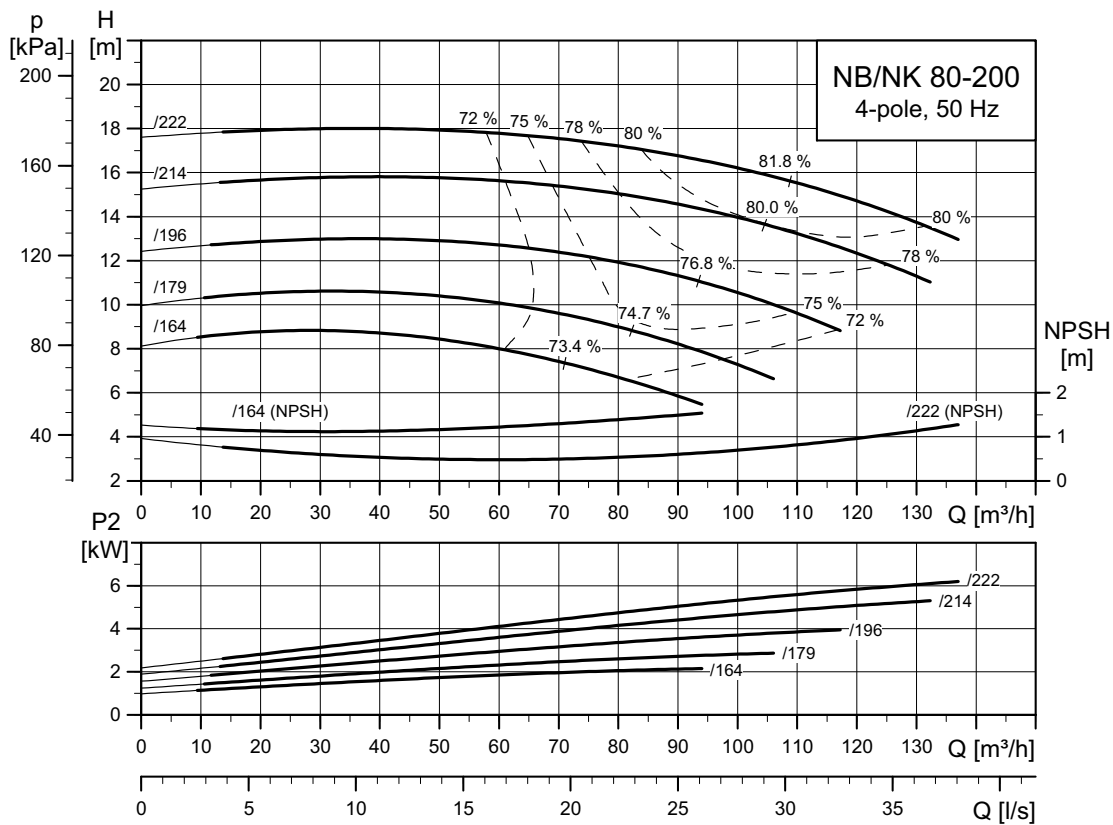

TM03 5140 3414

NB, NK 80-250

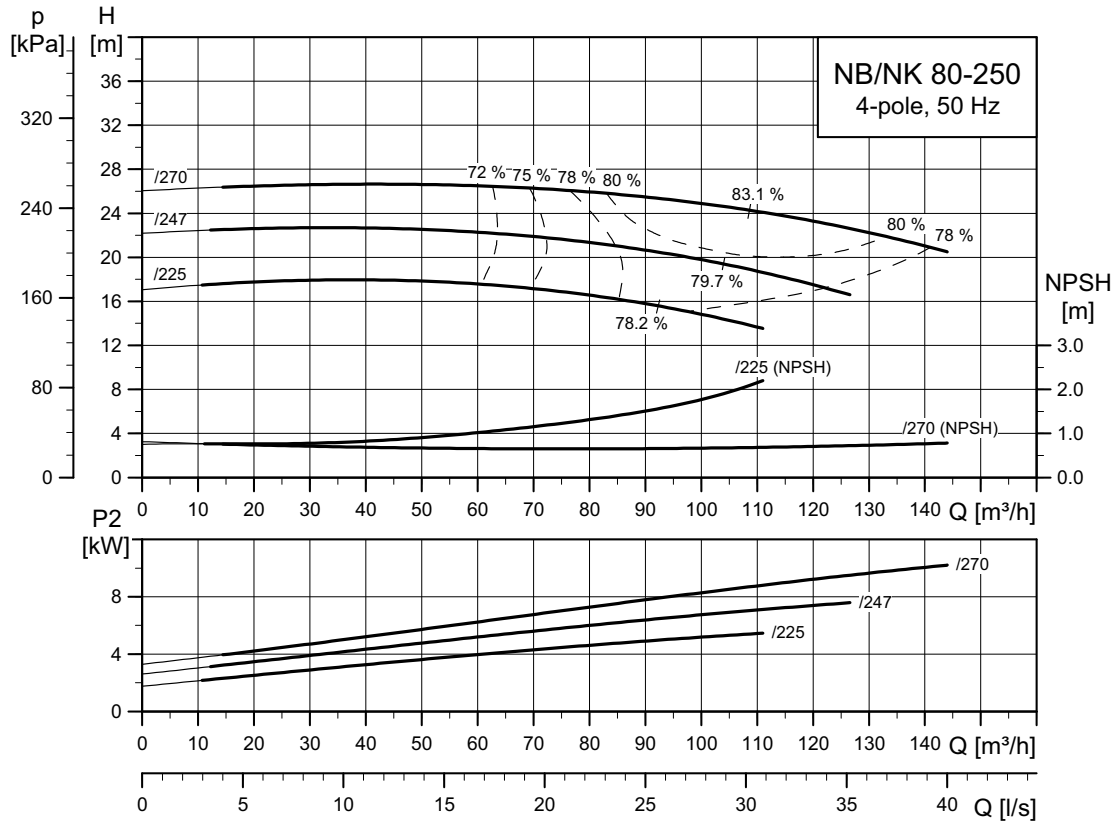

TM03 5141 3414

NB, NK 80-315

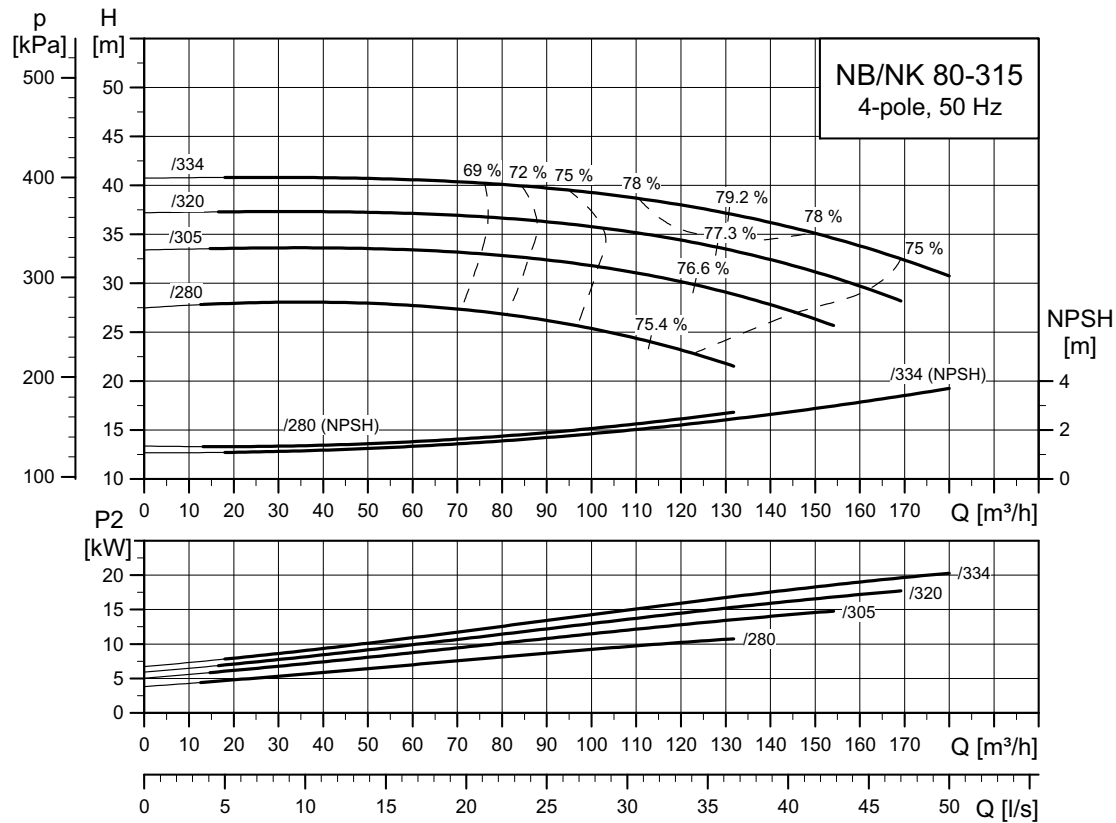

TM03 5142 3414

NB, NK 80-400

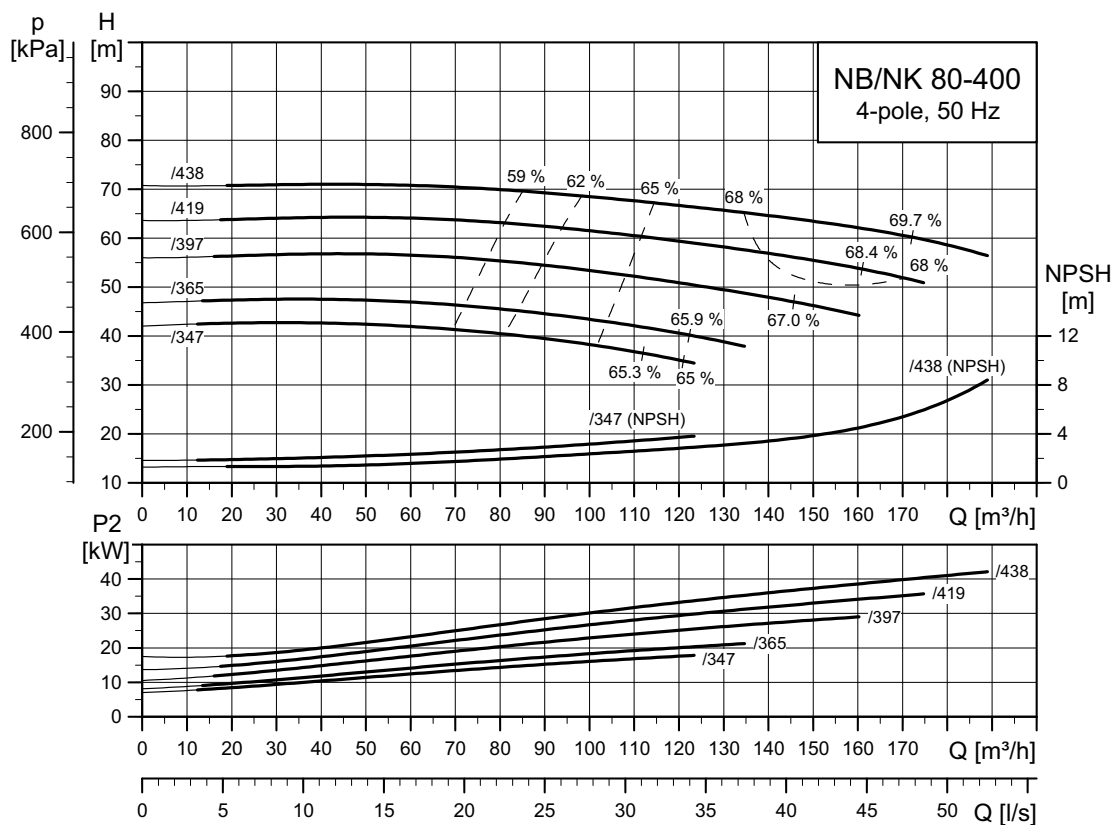

TM03 5143 3414

NB, NK 100-160

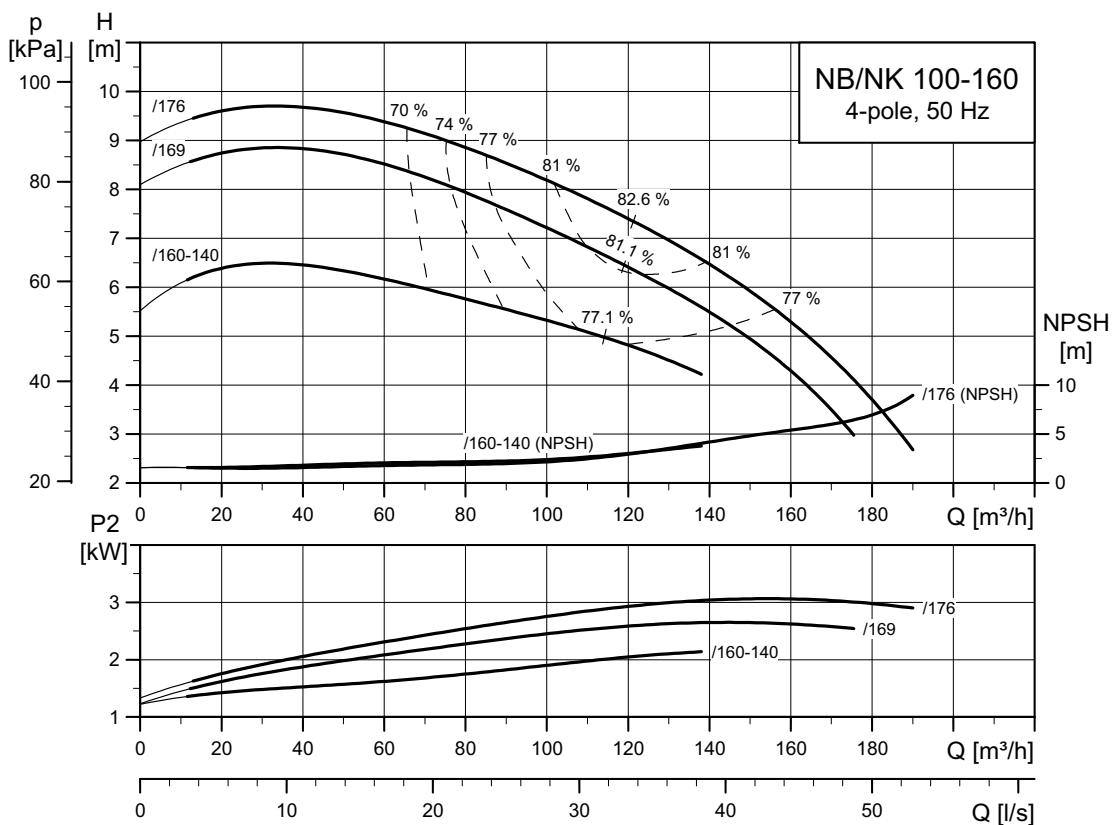

TM03 5144 2715

NB, NK 100-200

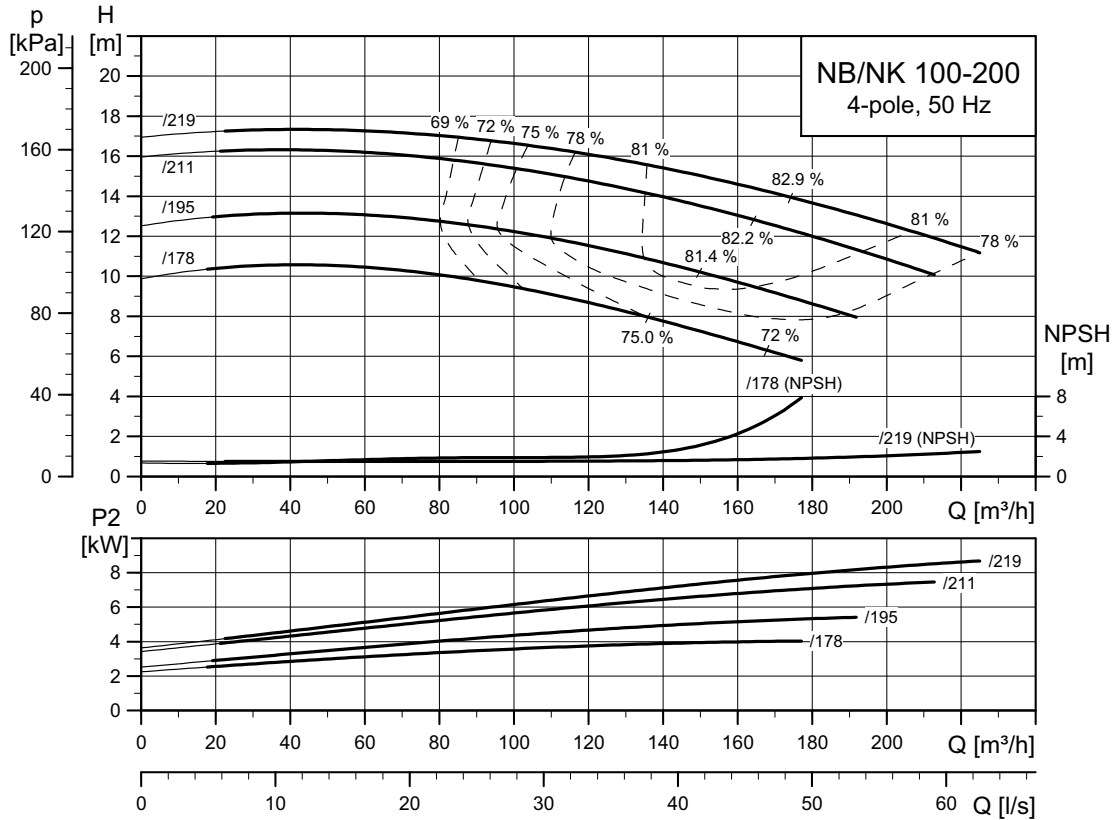

TM03 5145 3414

NB, NK 100-250

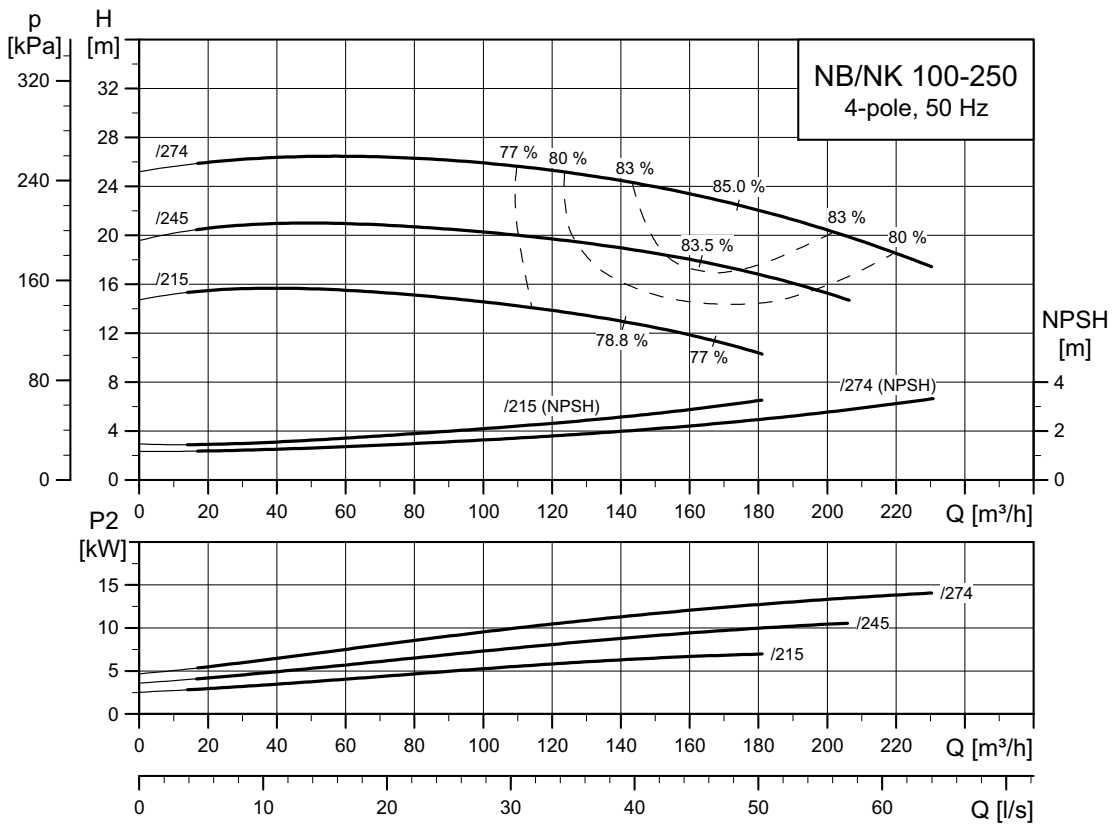

TM03 5146 4115

NB, NK 100-315

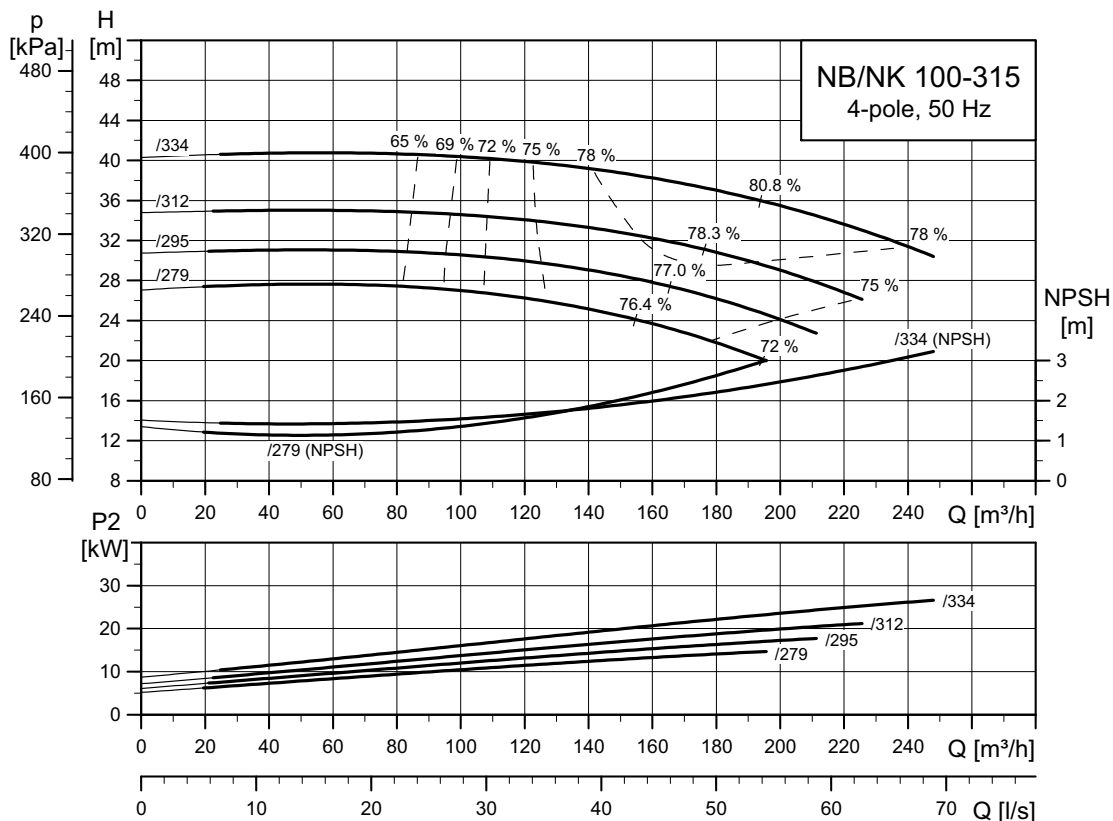

TM03 5147 3414

NB, NK 100-400

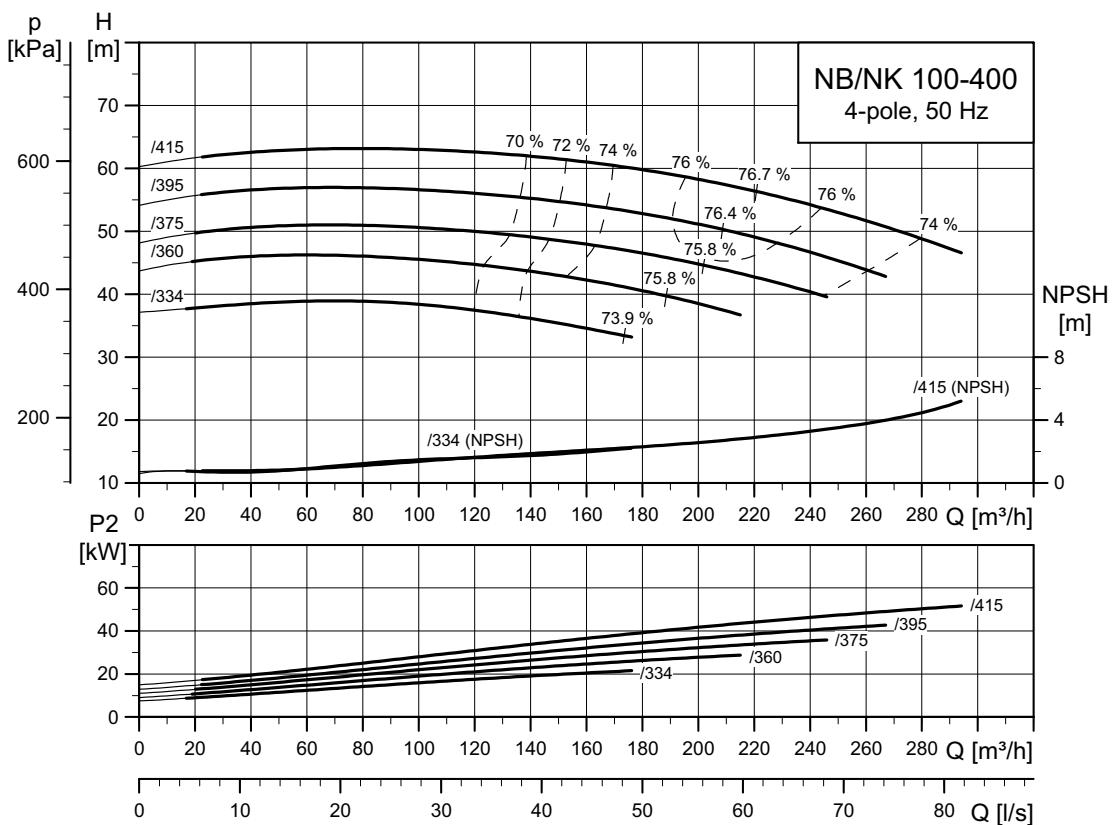

TM03 5148 2715

NB, NK 125-200

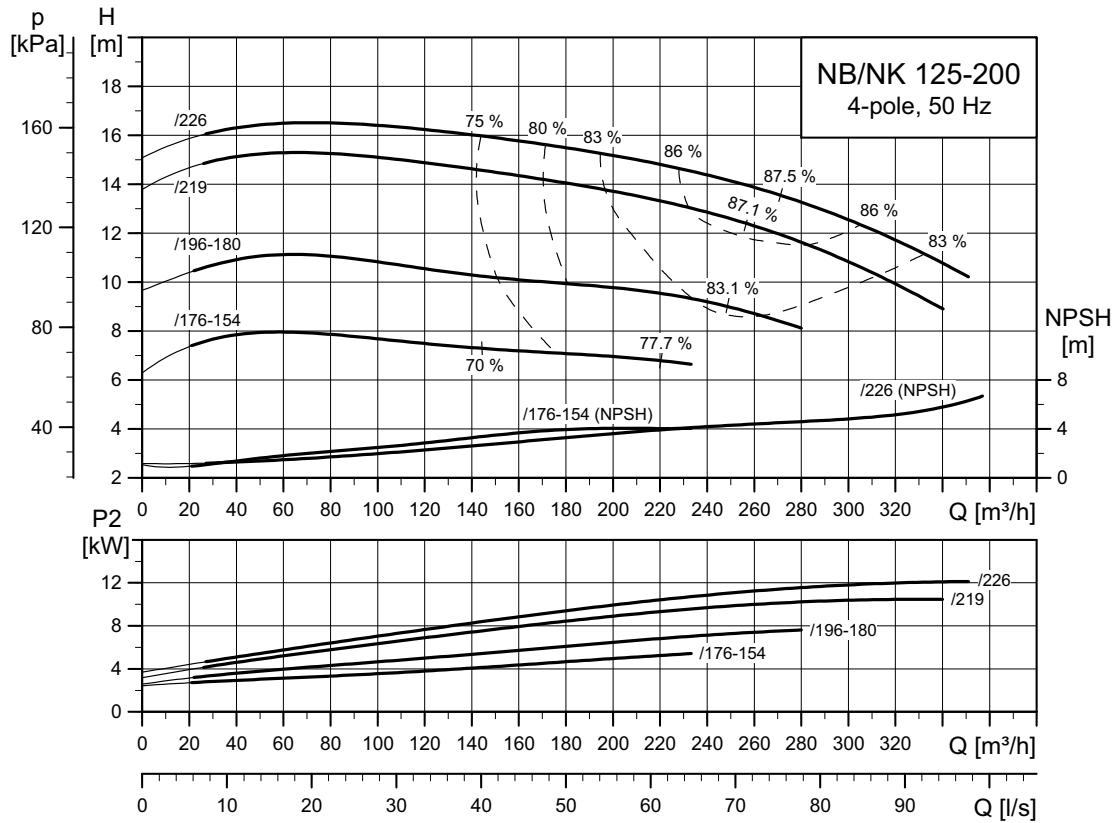

TM03 5149 4115

NB, NK 125-250

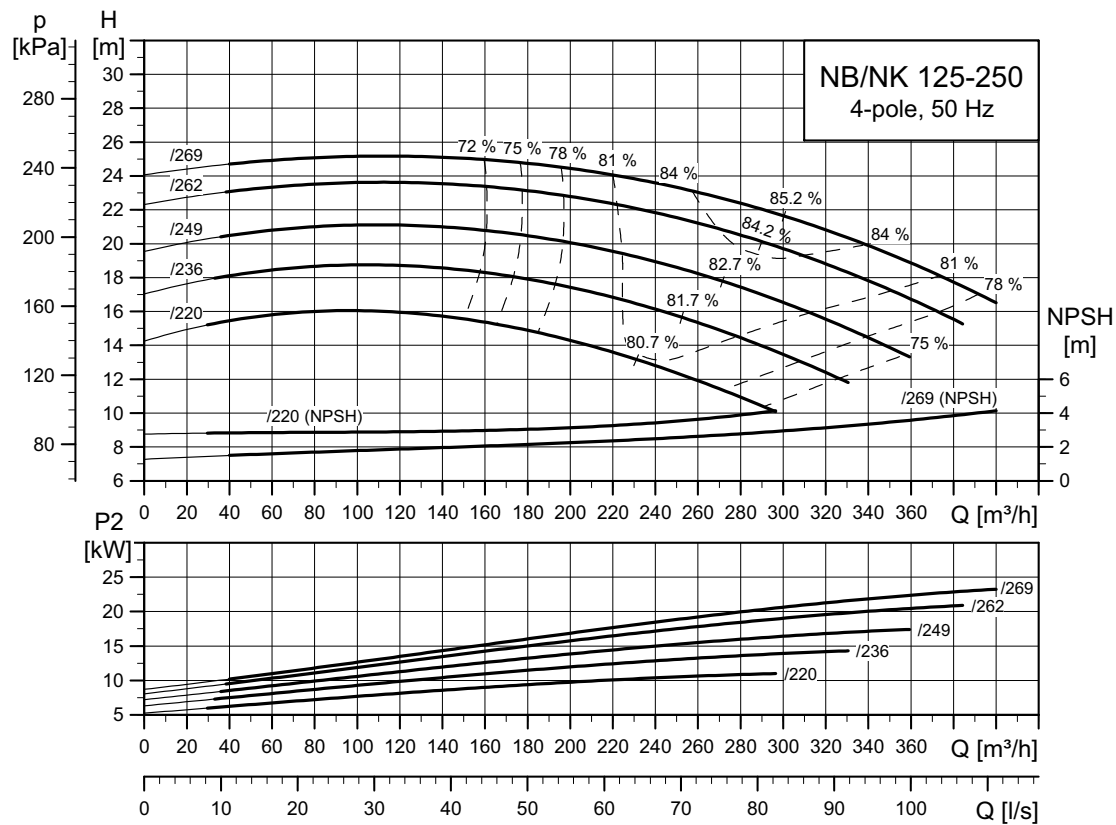

TM03 5150 3414

NB, NK 125-315

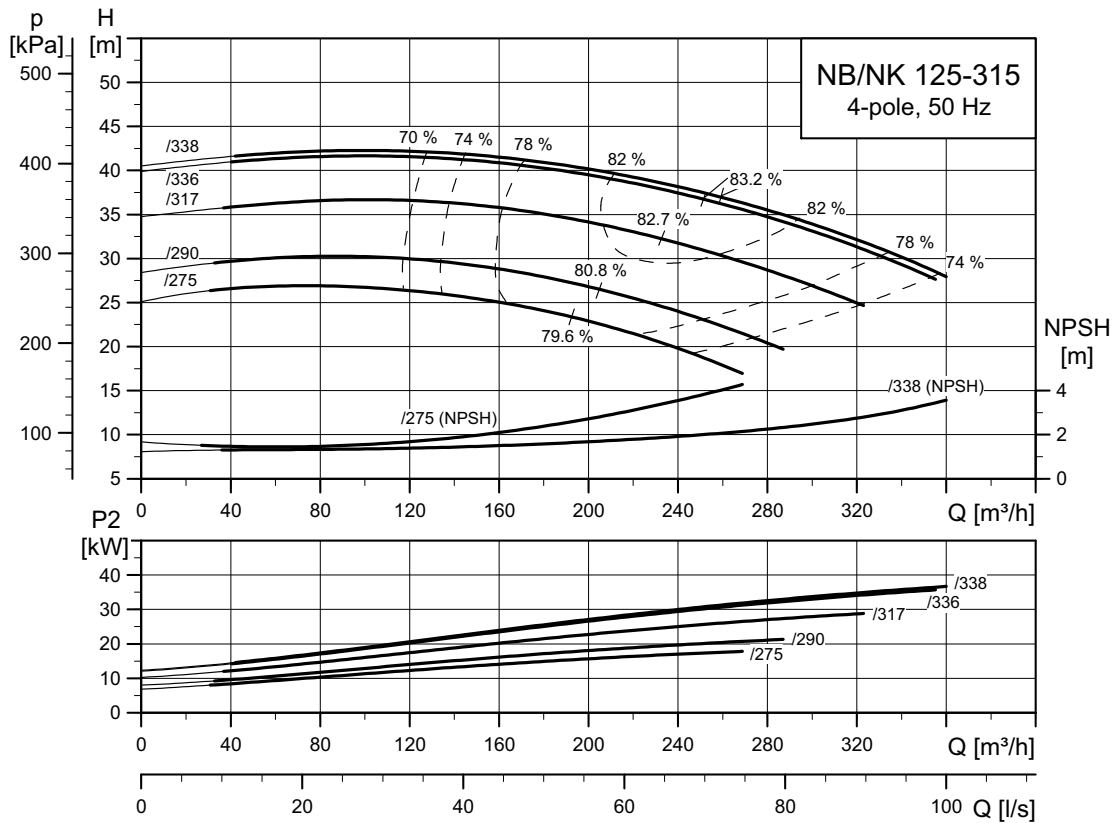

TM03 5151 3414

NB, NK 125-400

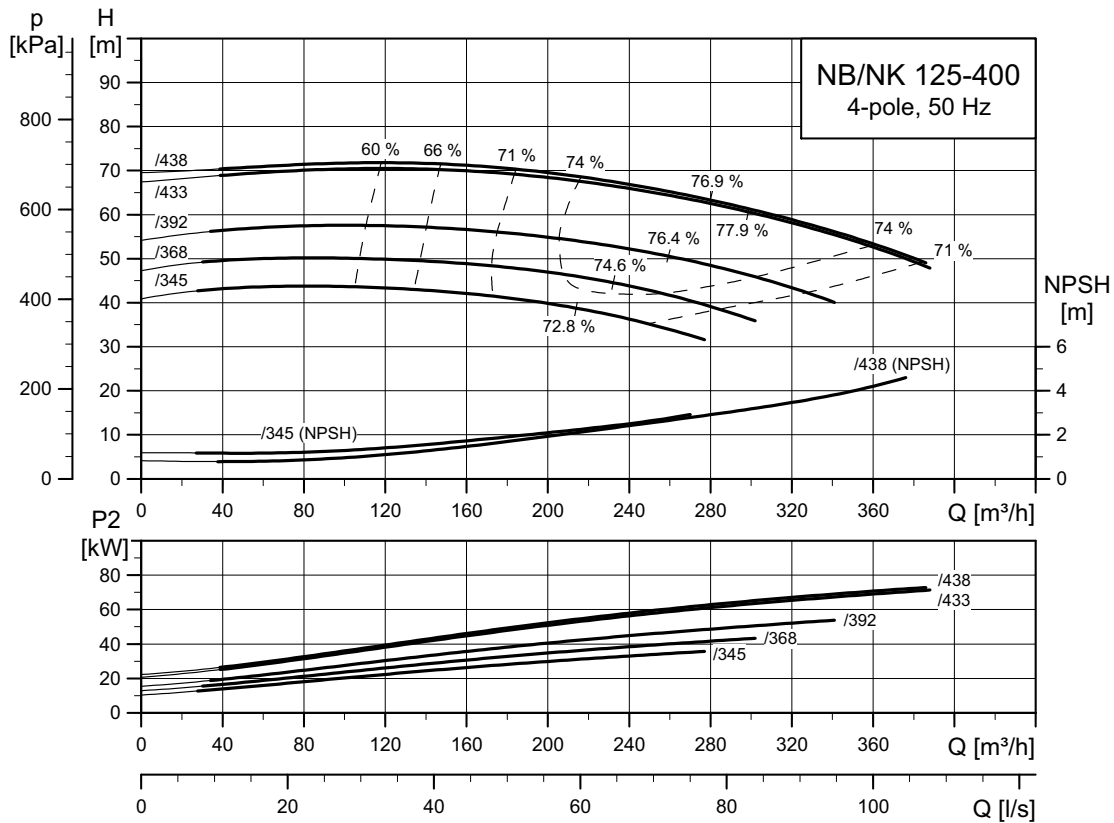

TM05 2347 3414

NB, NK 125-500

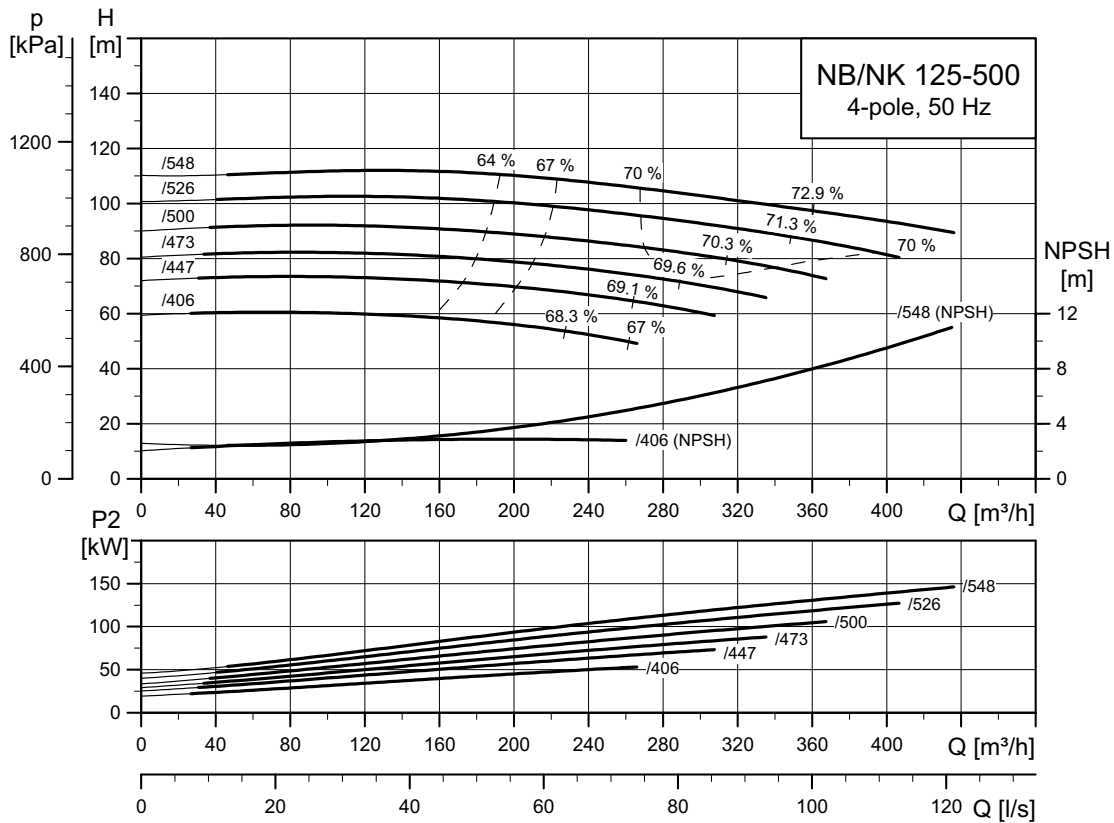

TM03 5153 3414

NB, NK 150-200

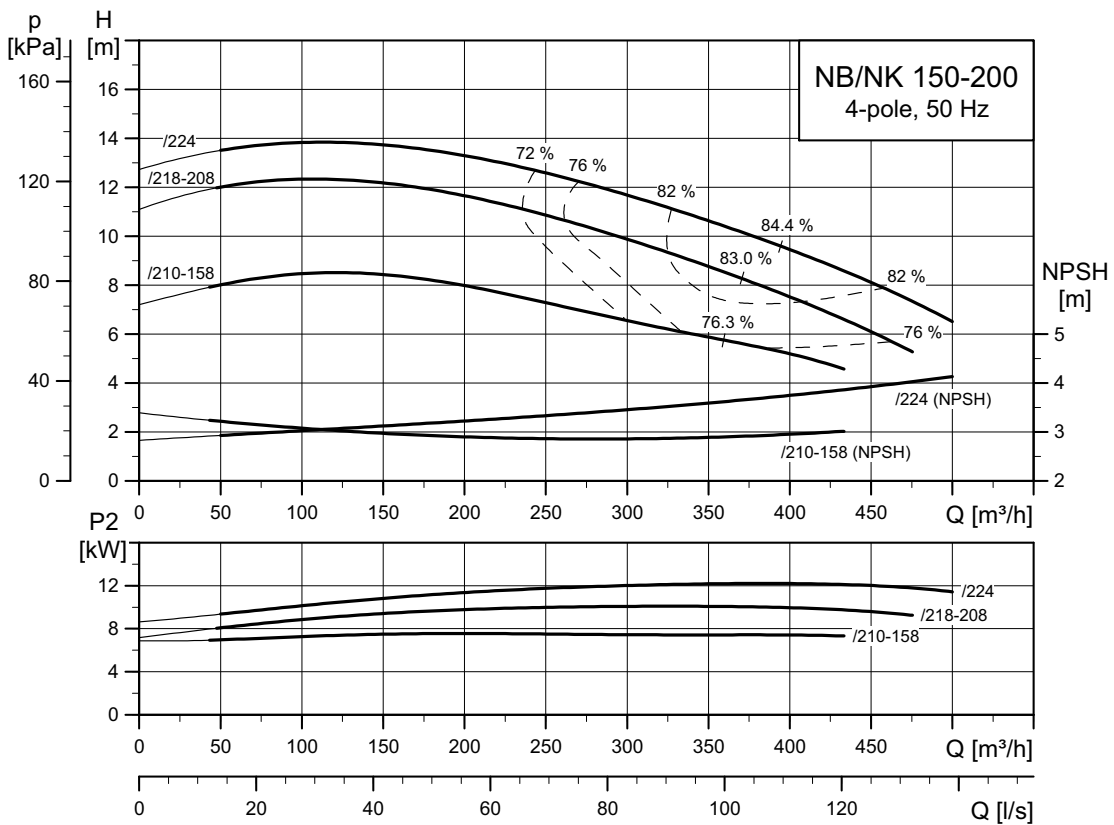

TM03 5154 3414

NB, NK 150-250

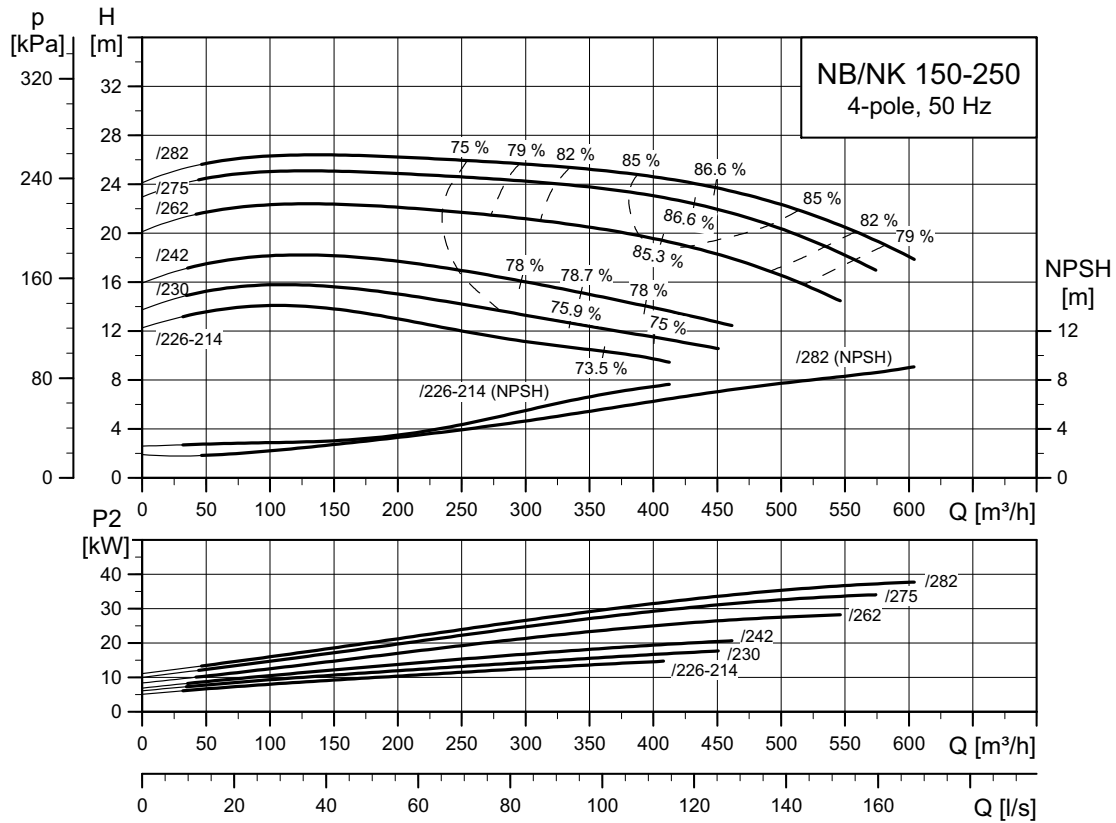

TM03 5155 3414

NB, NK 150-315.2

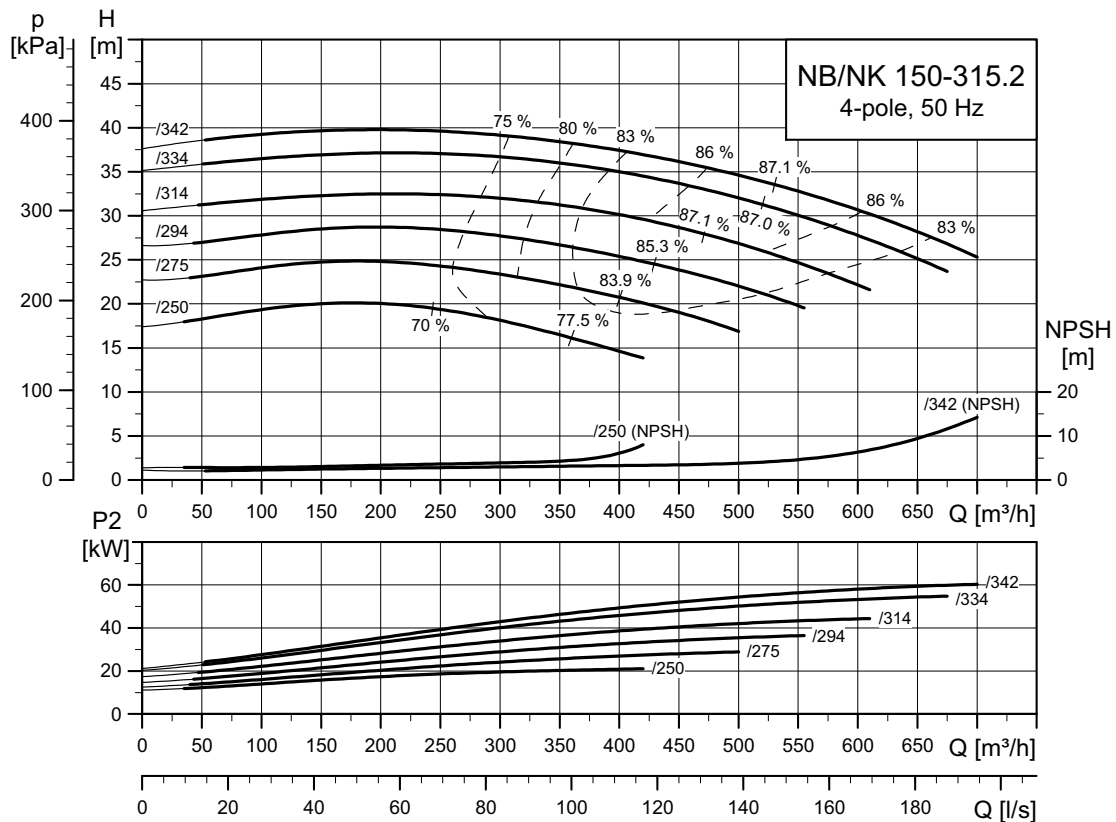

TM06 4751 3315

NB, NK 150-315

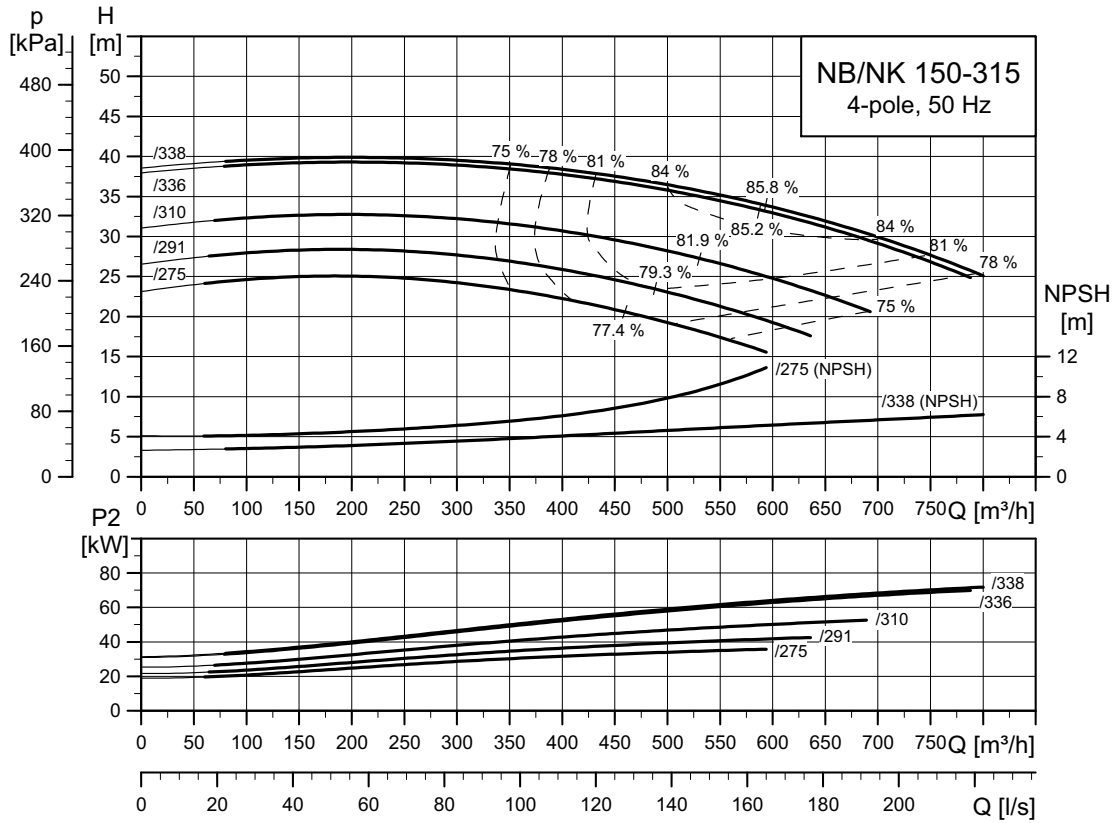

TM03 5156 3414

NB, NK 150-400

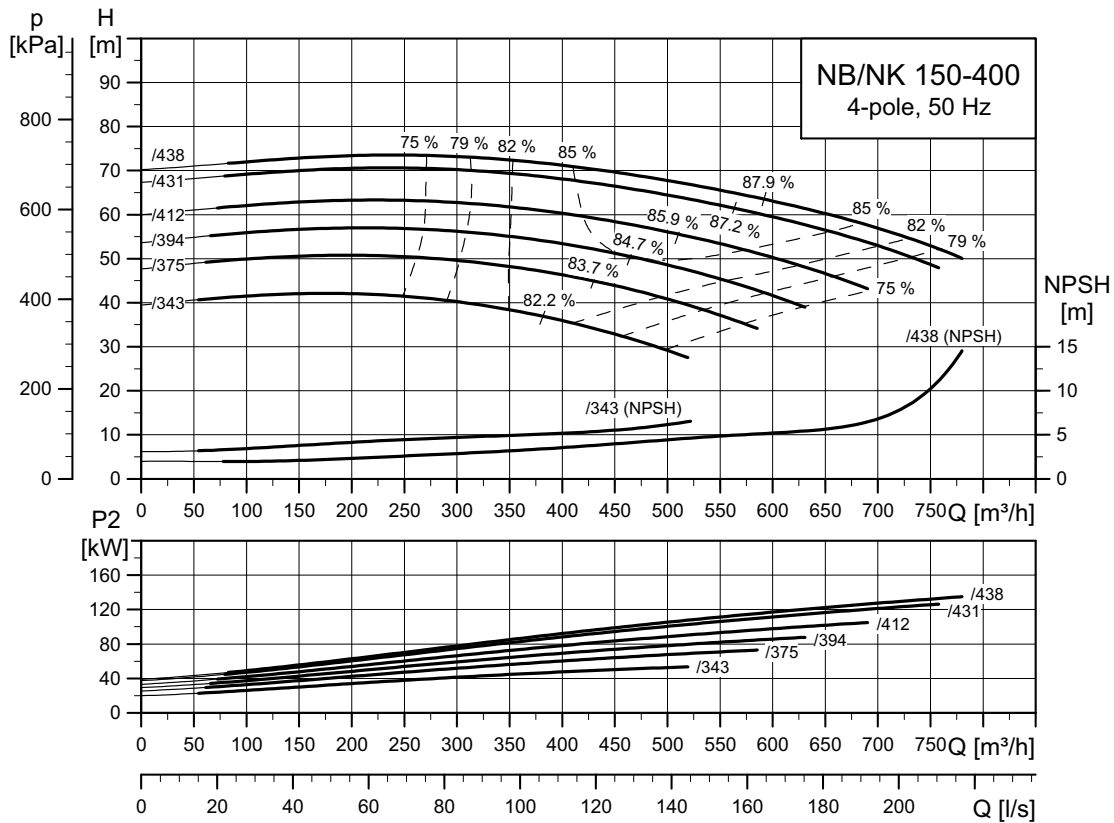

TM03 5157 3414

NB, NK 150-500

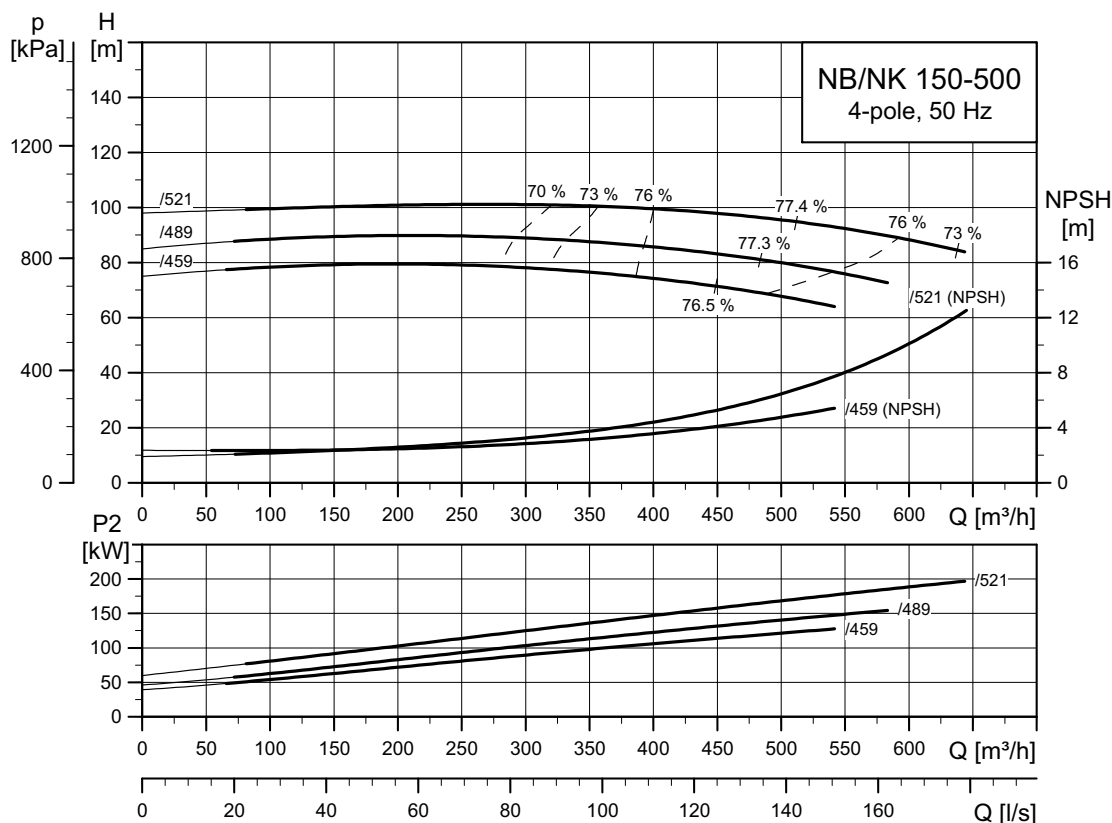

TM03 5158 3414

NB, NK 200-400

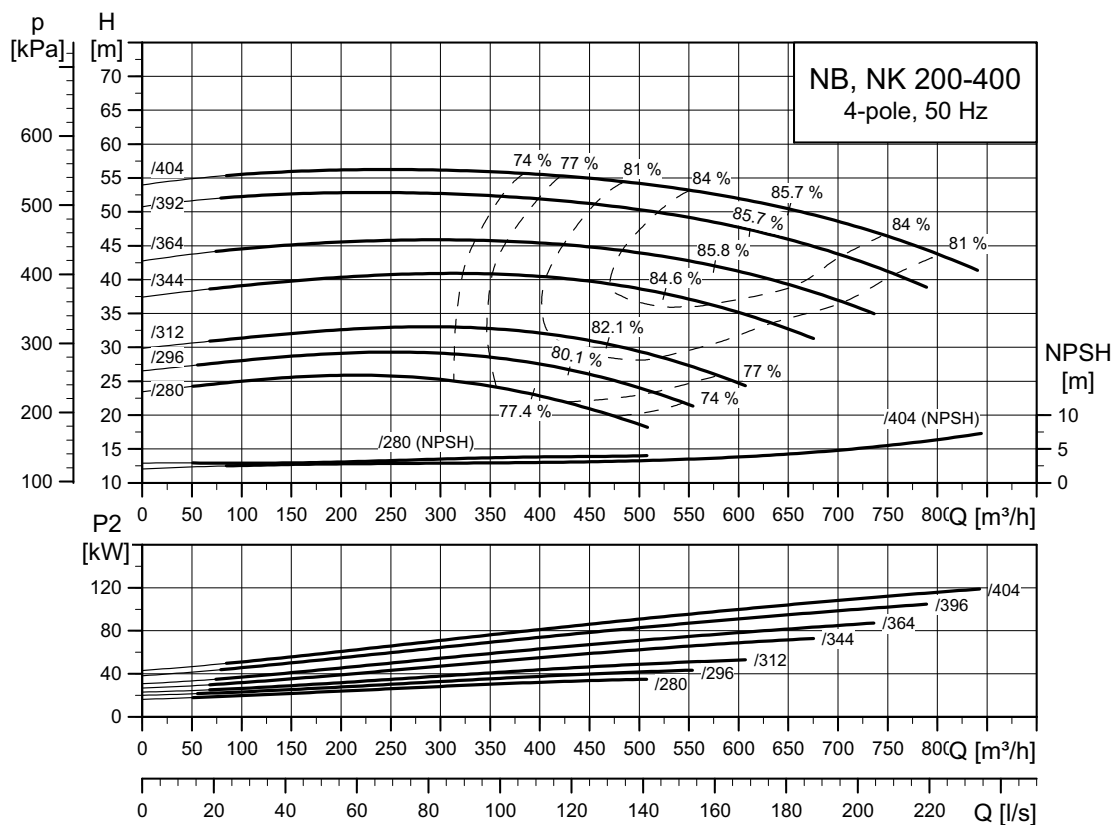

TM04 4835 3414

NB, NK 200-450

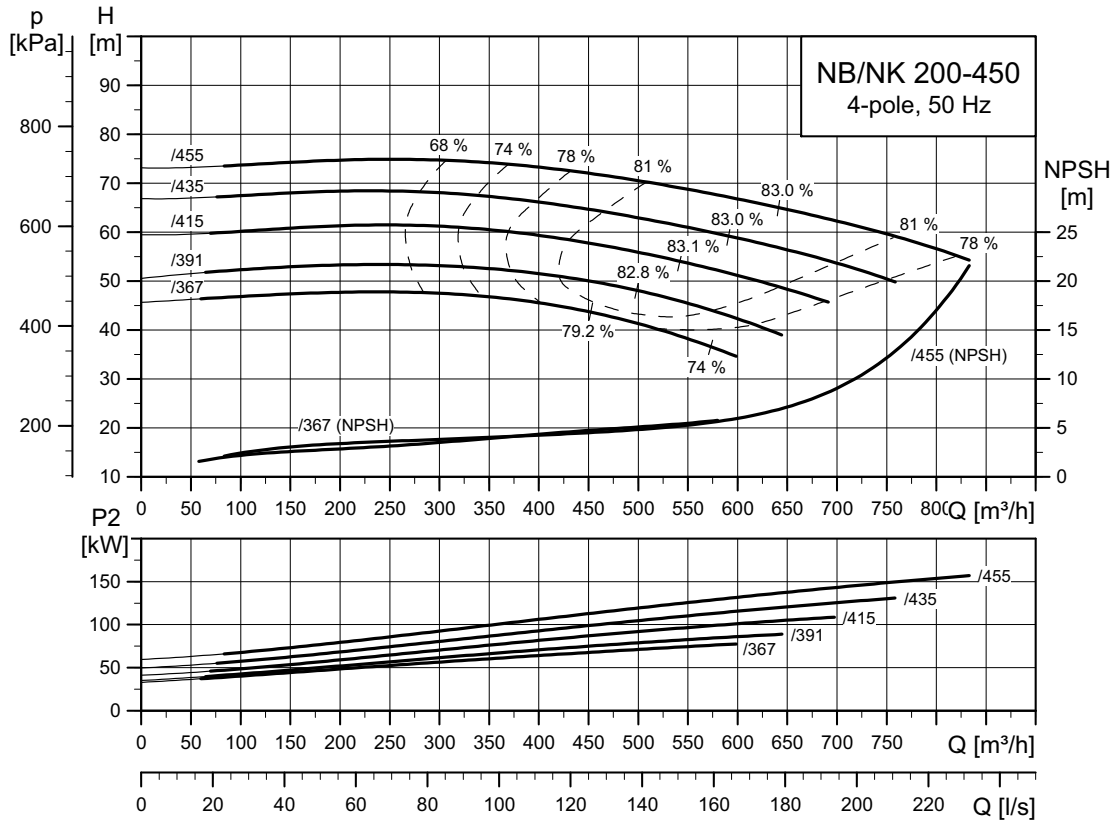

TM04 3967 3414

NB, NK 250-350

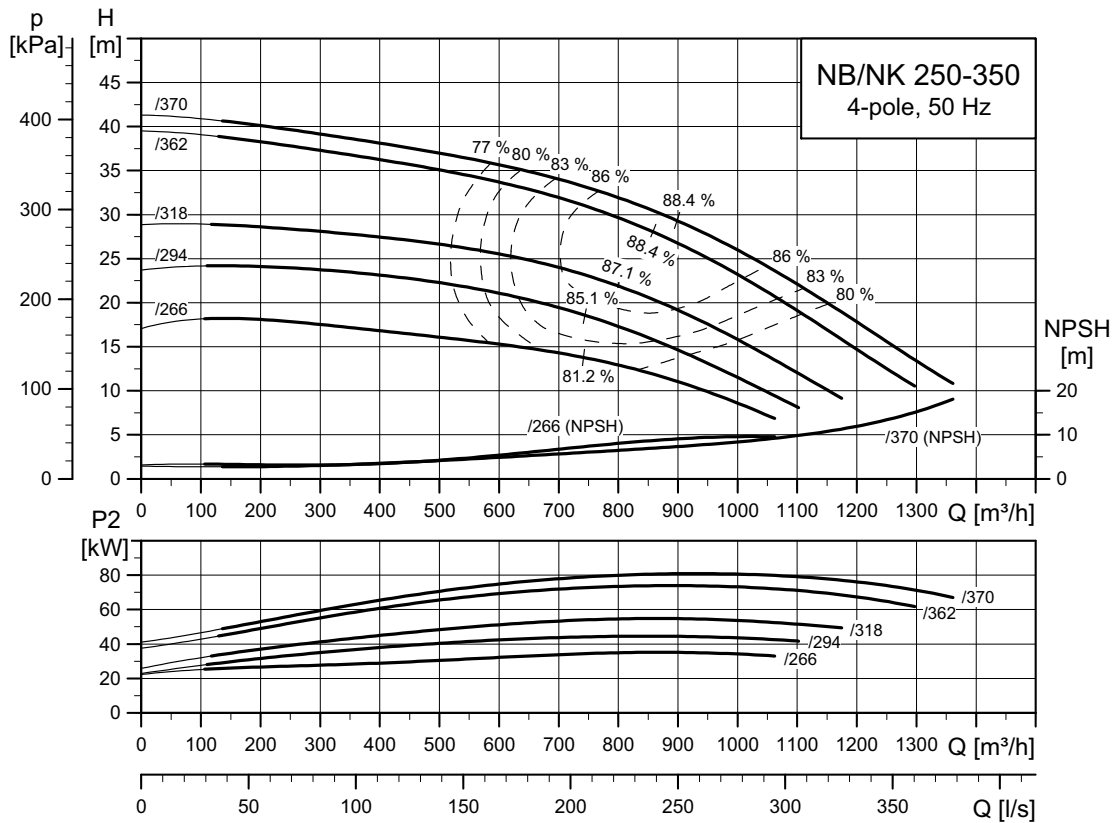

TM04 5997 3414

NB, NK 250-400

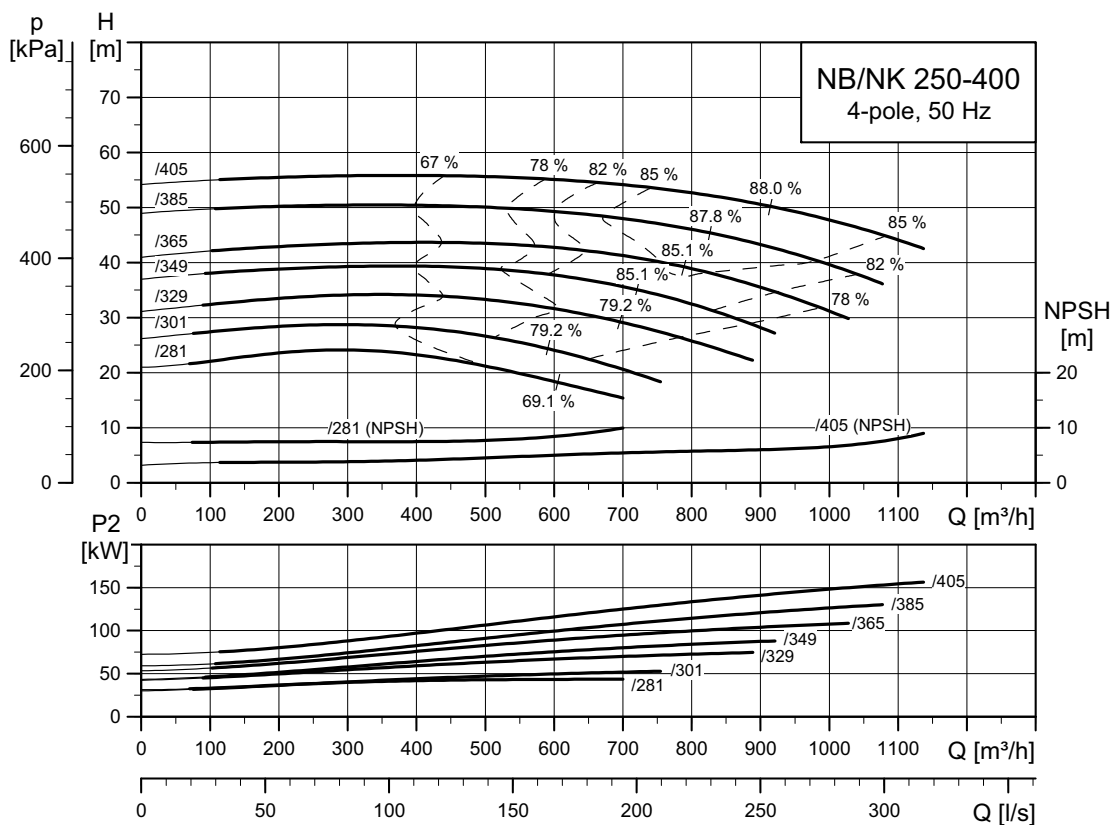

TM04 4022 3414

NB, NK 250-450

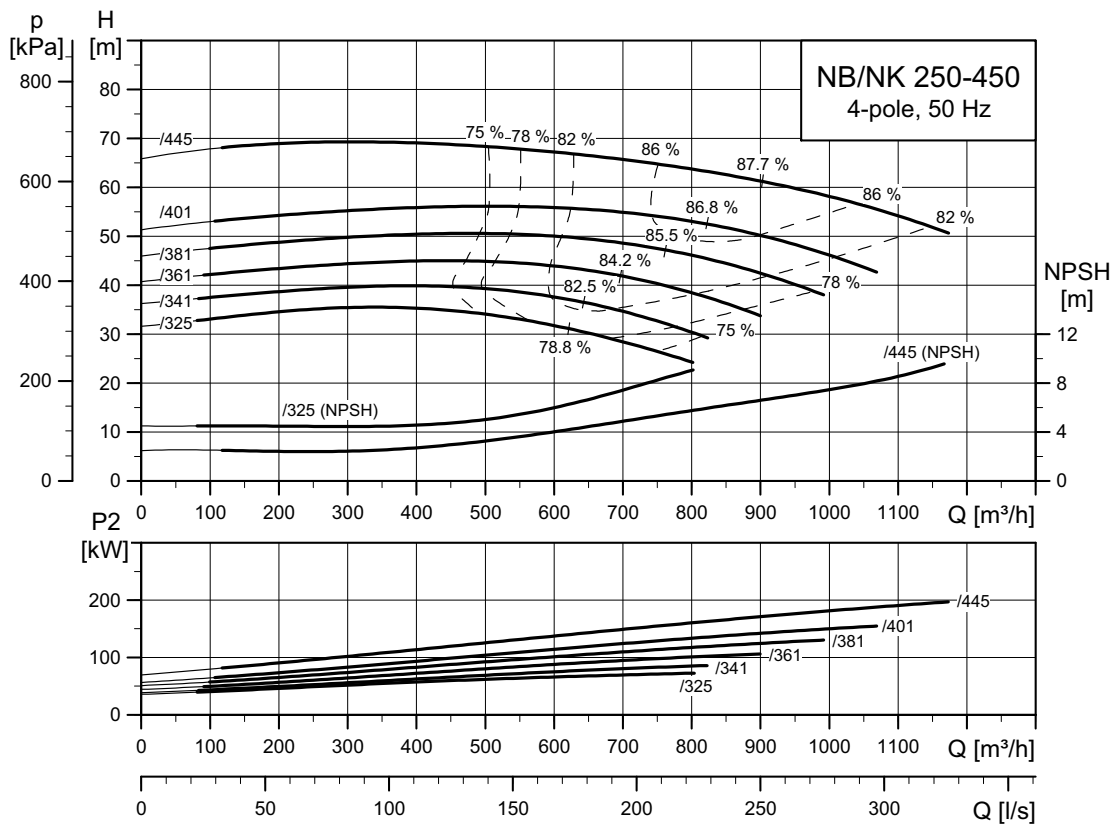

TM04 4839 3414

NB, NK 250-500

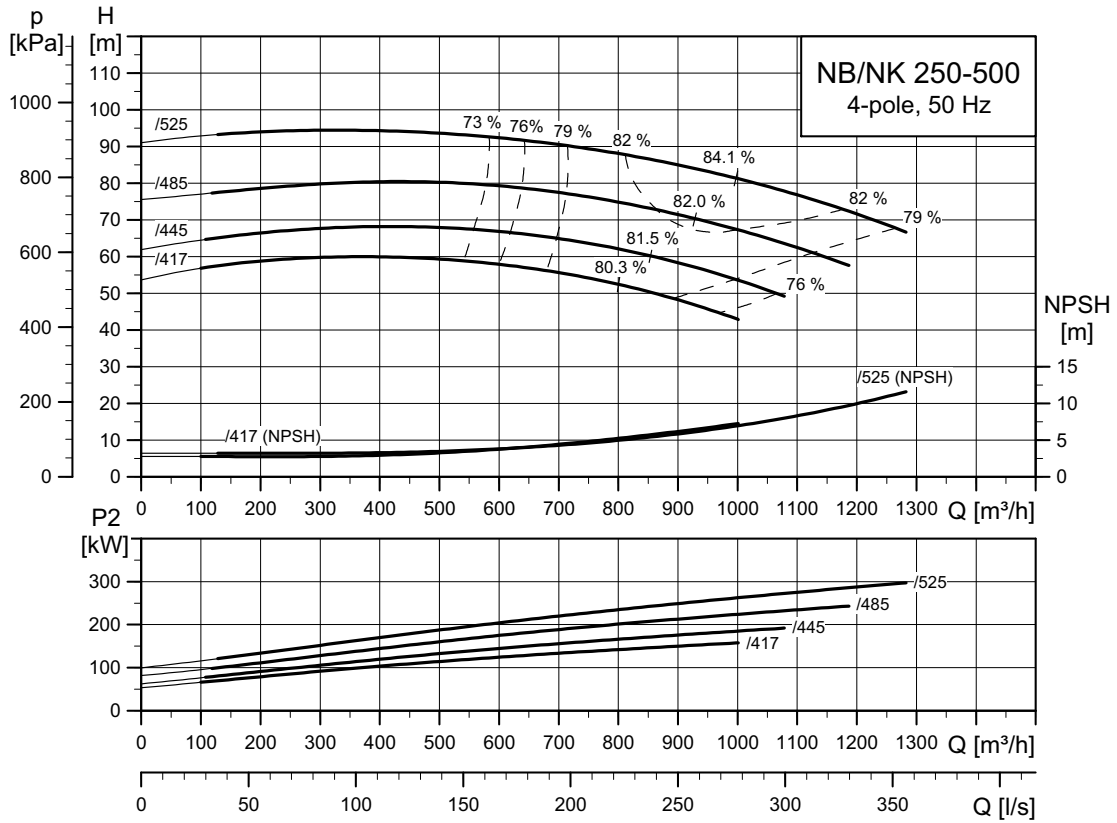

TM04 6001 3414

6-pole

NB, NK 100-160

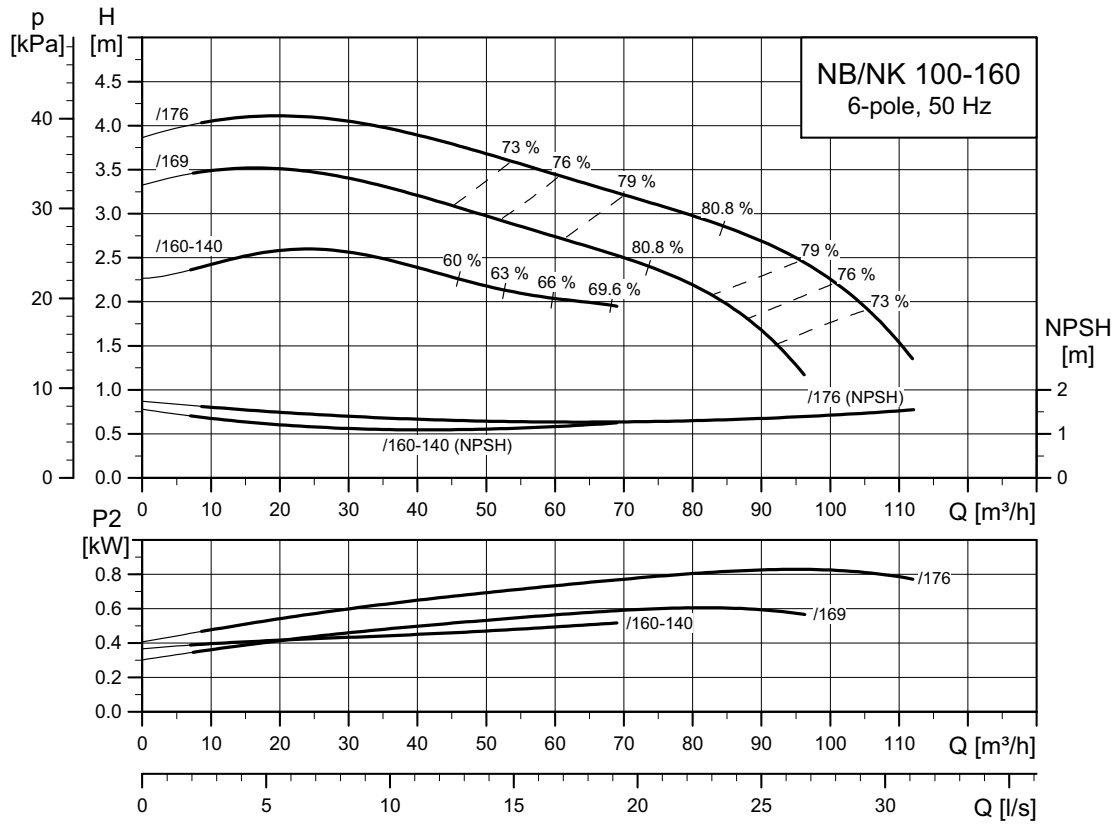

TM03 5159 3414

NB, NK 100-200

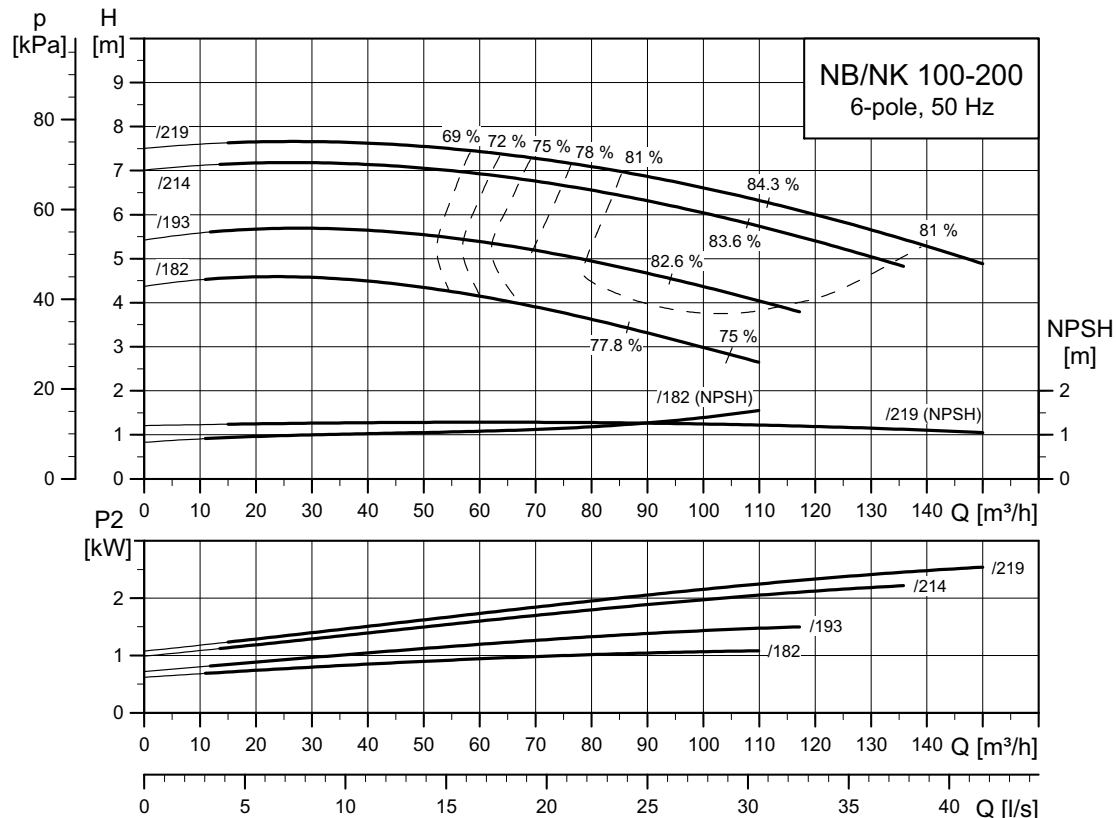

TM03 5160 3414

NB, NK 100-250

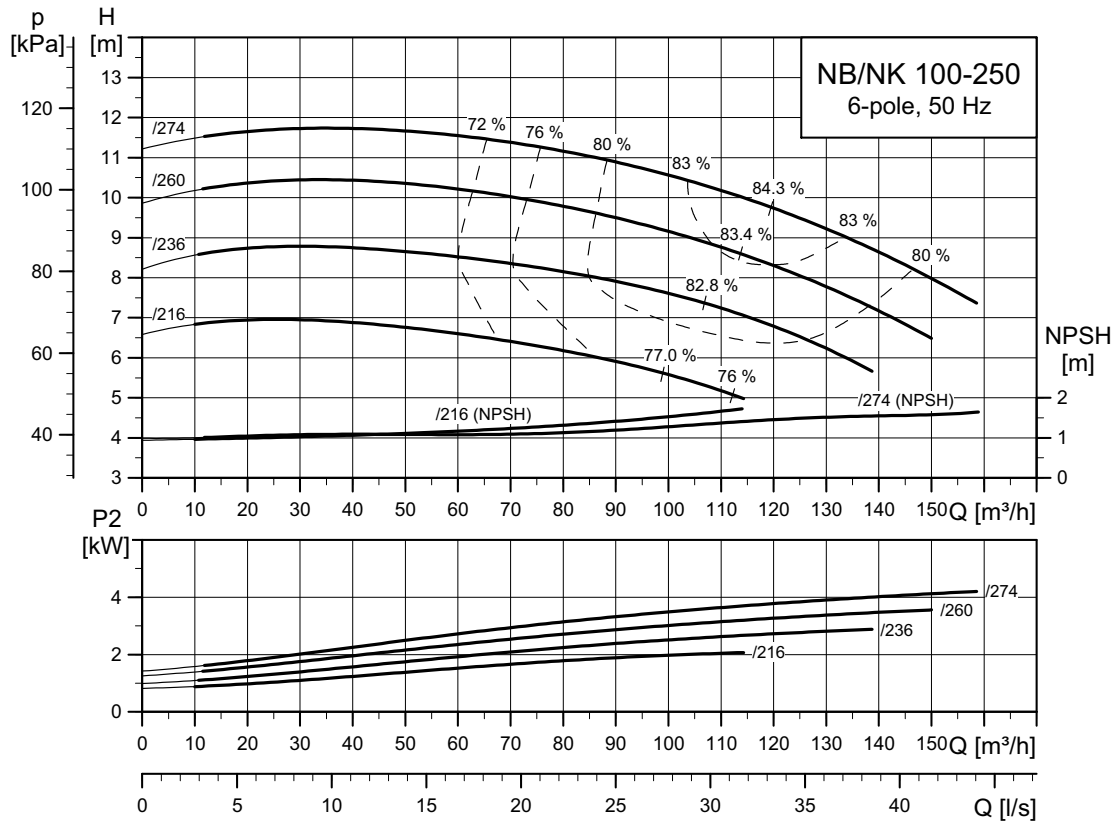

TM03 5161 4115

NB, NK 100-315

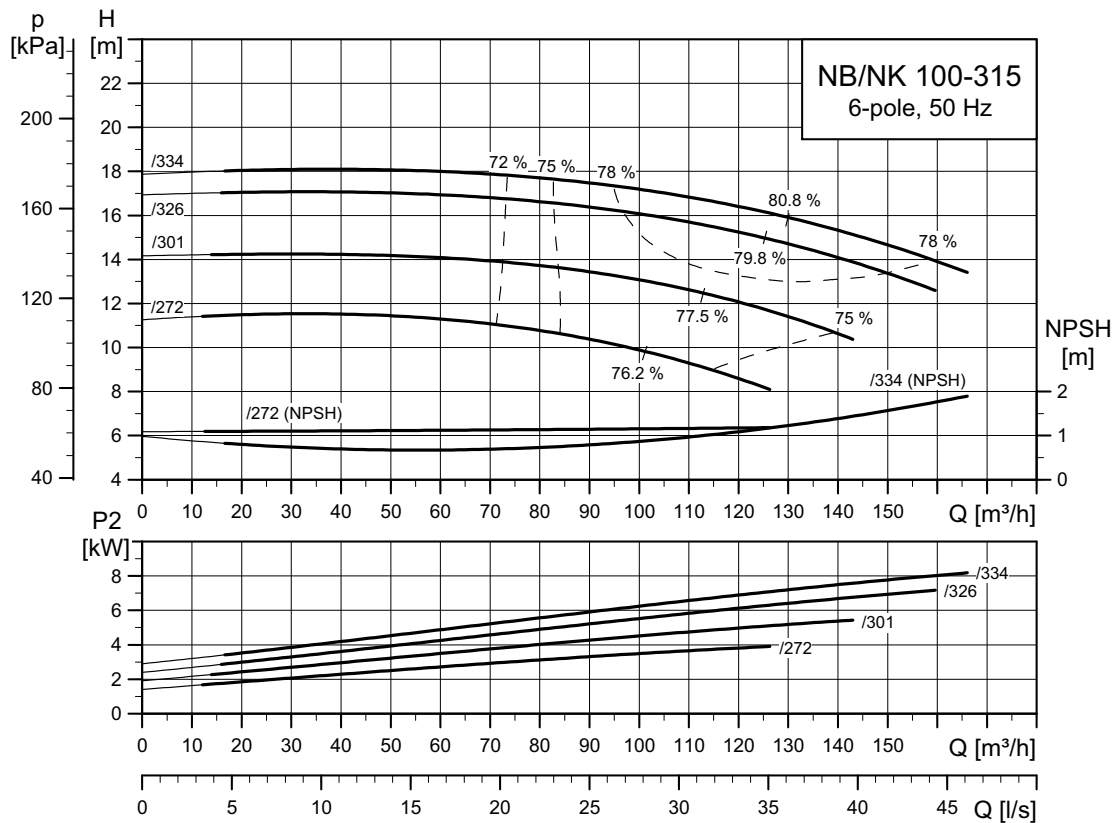

TM03 5162 3414

NB, NK 100-400

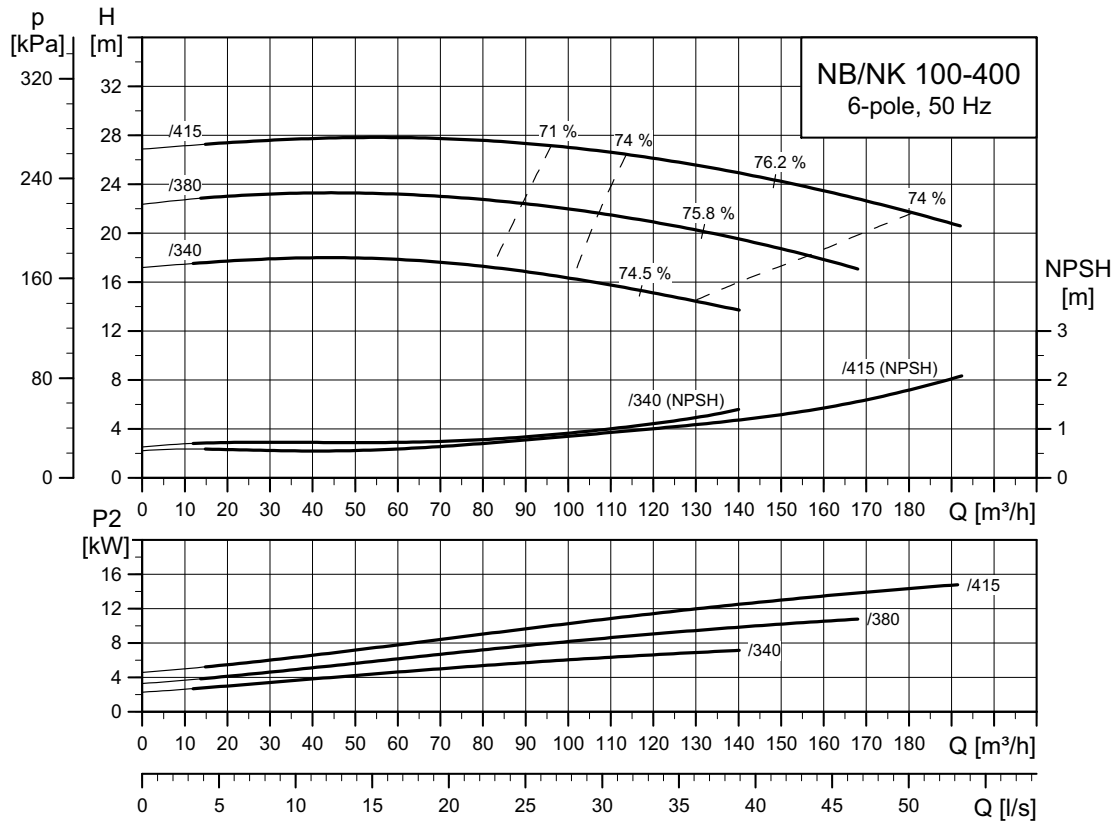

TM03 5163 2715

NB, NK 125-200

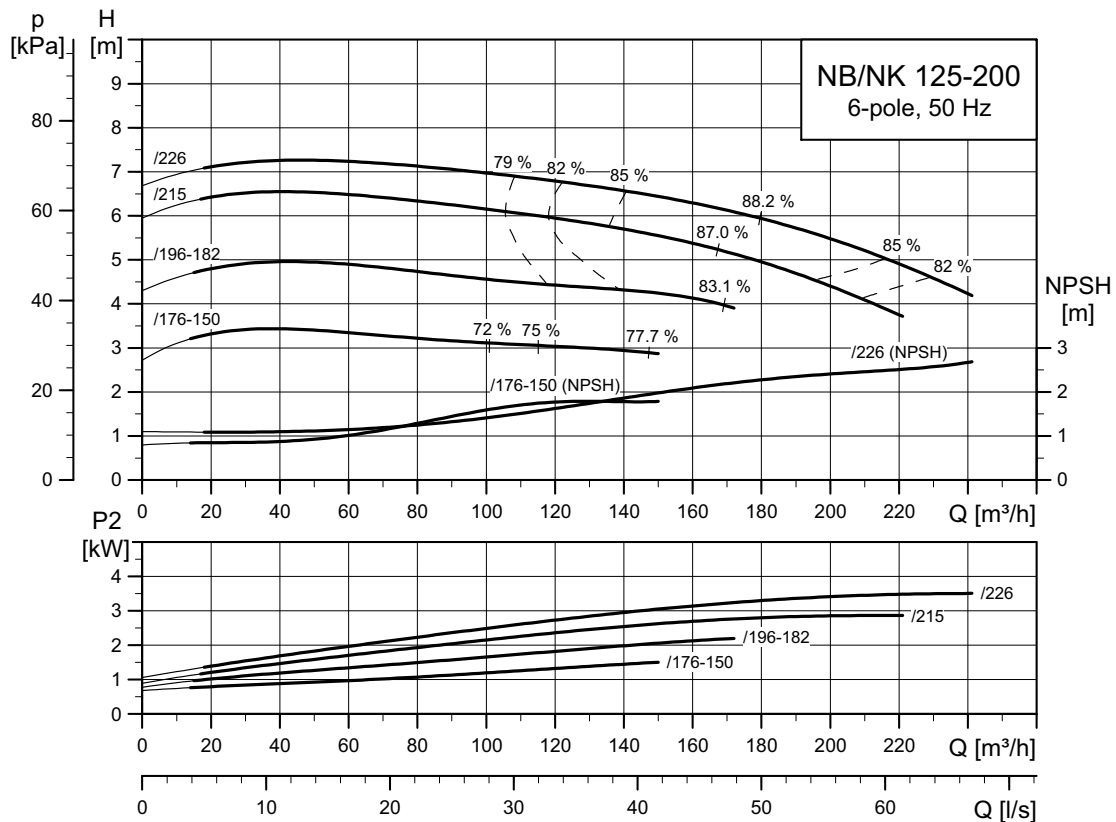

TM03 5164 4115

NB, NK 125-250

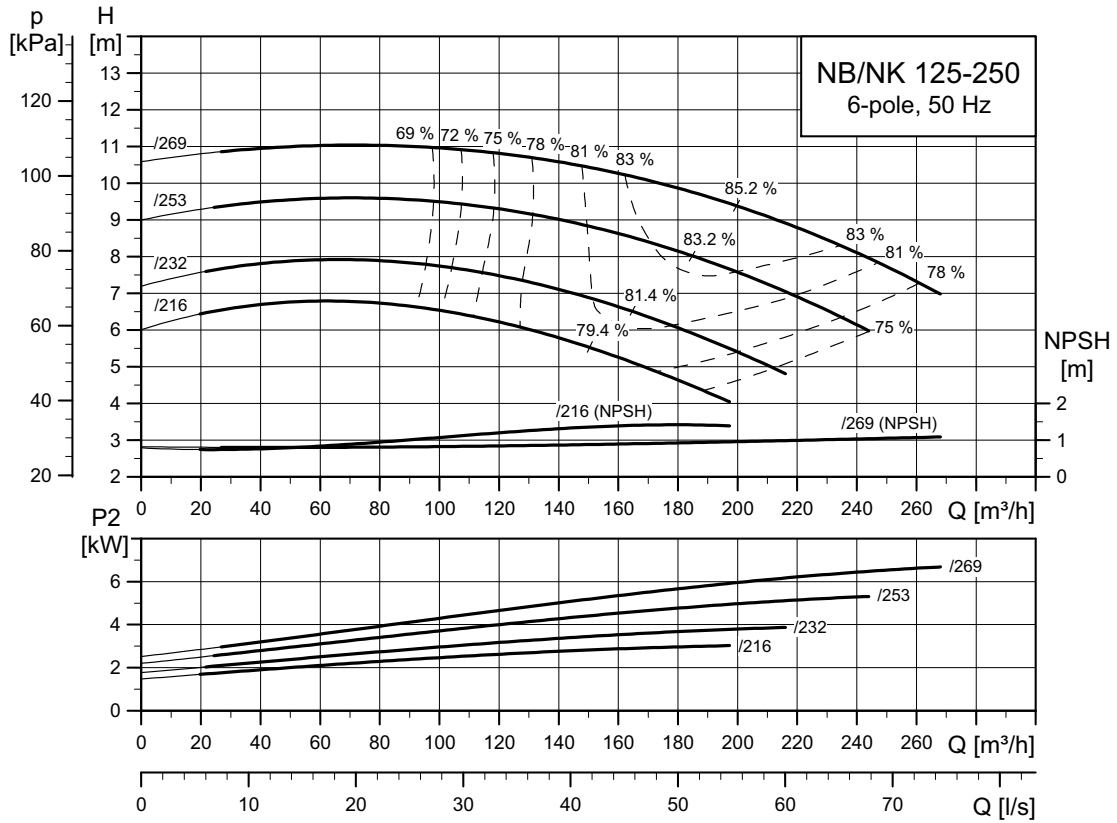

TM03 5165 3414

NB, NK 125-315

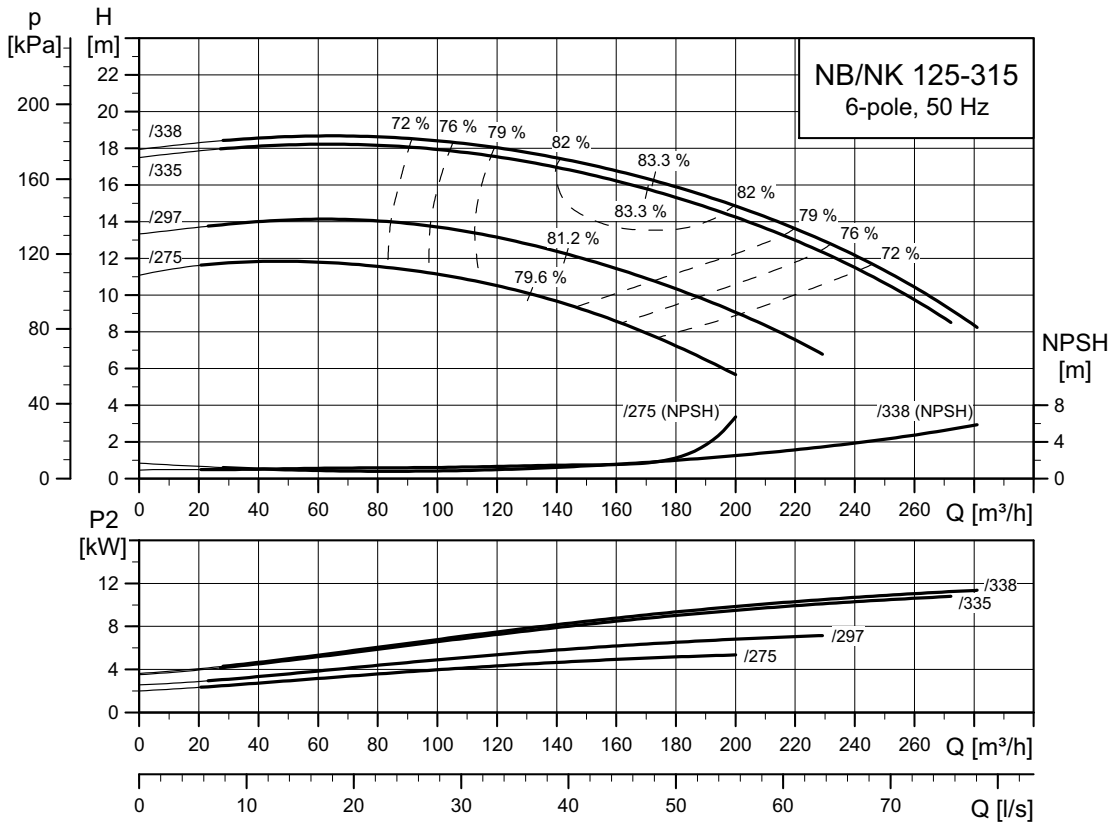

TM03 5166 3414

NB, NK 125-400

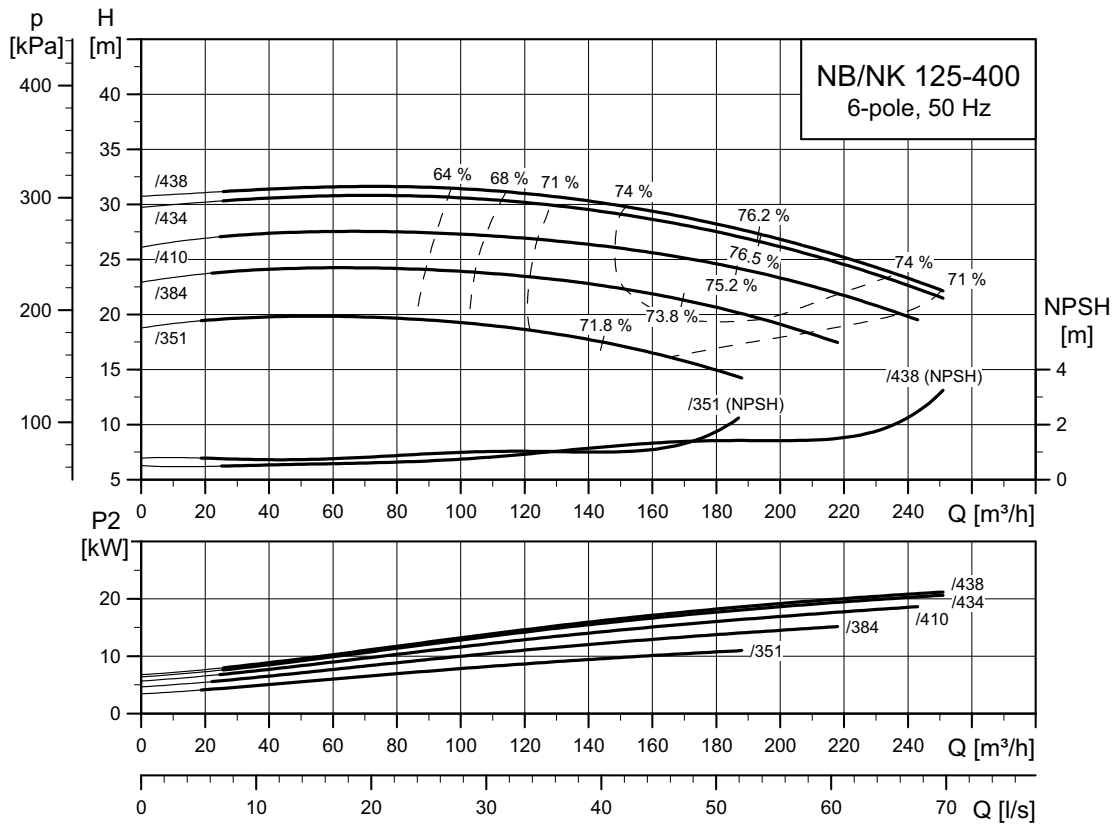

TM05 2348 3414

NB, NK 125-500

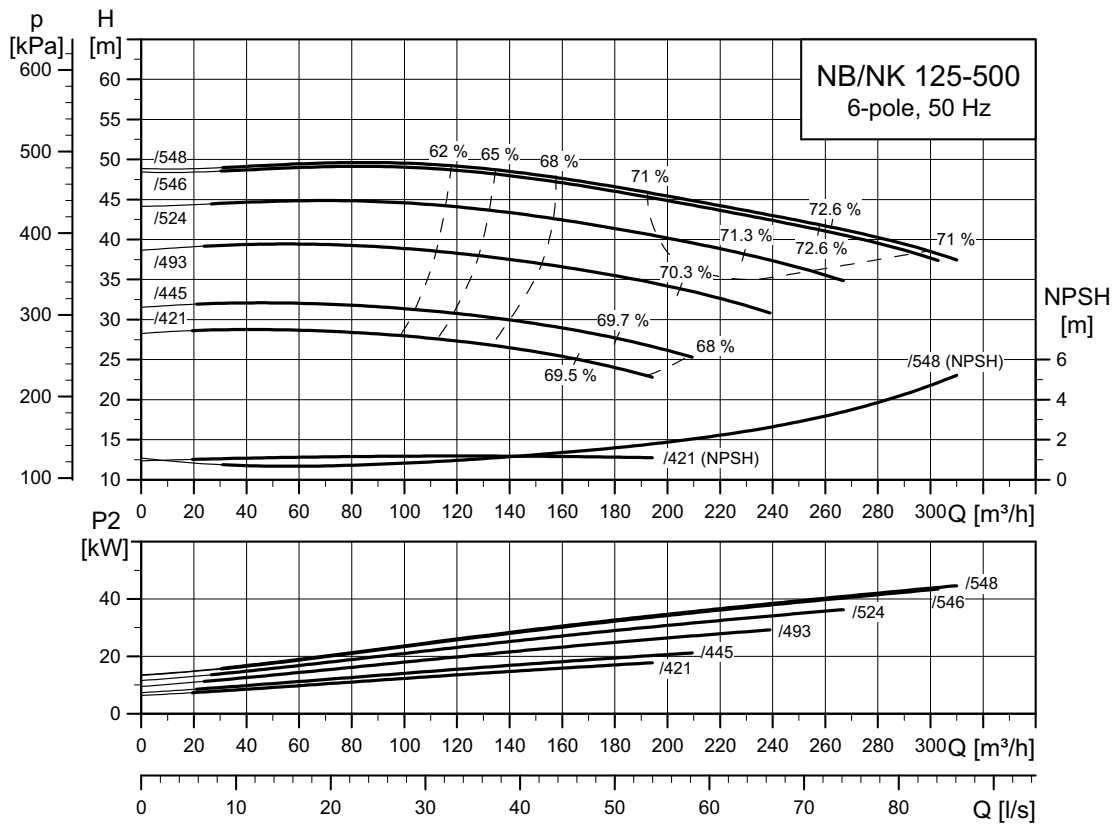

TM03 5168 3414

NB, NK 150-200

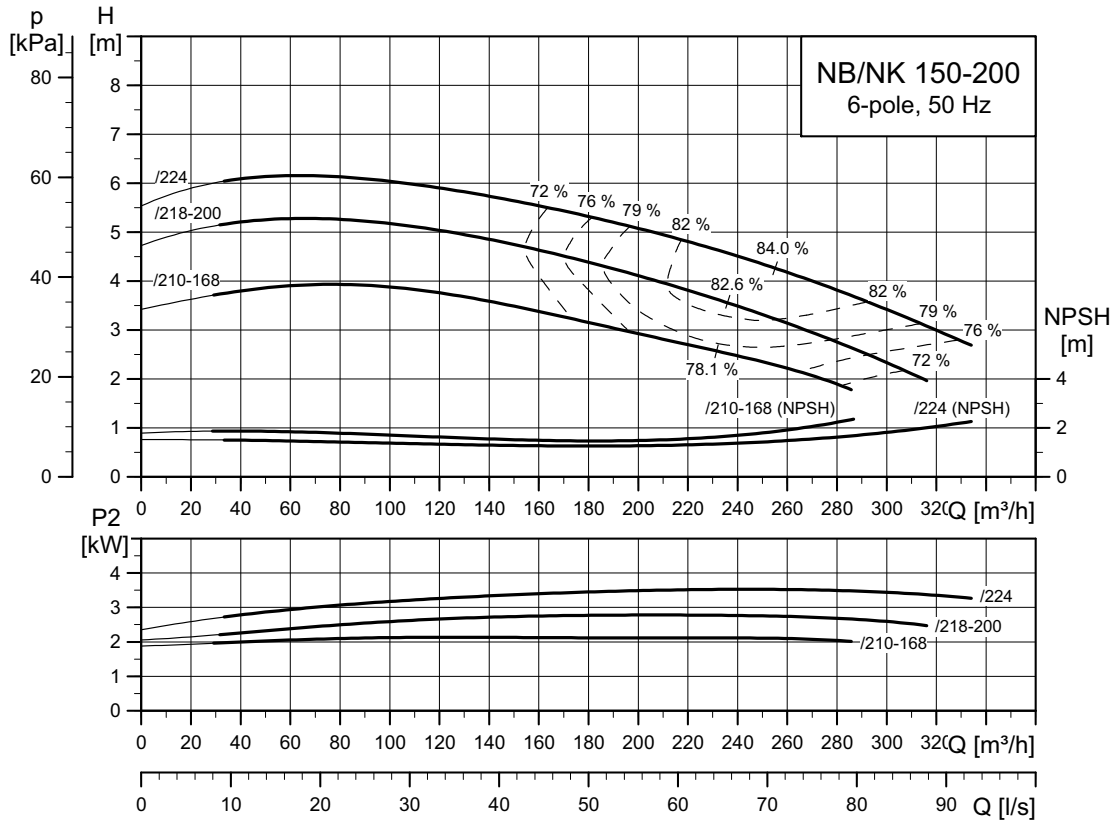

TM03 5169 3414

NB, NK 150-250

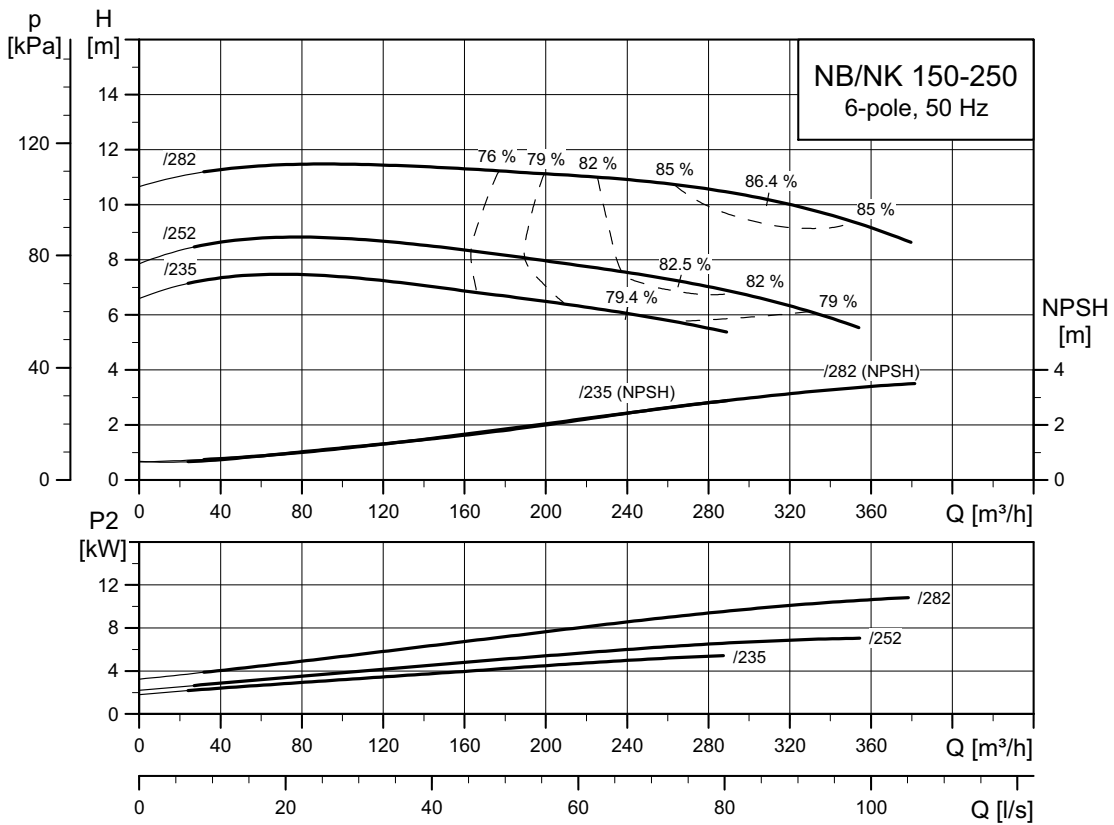

TM03 5170 3414

NB, NK 150-315.2

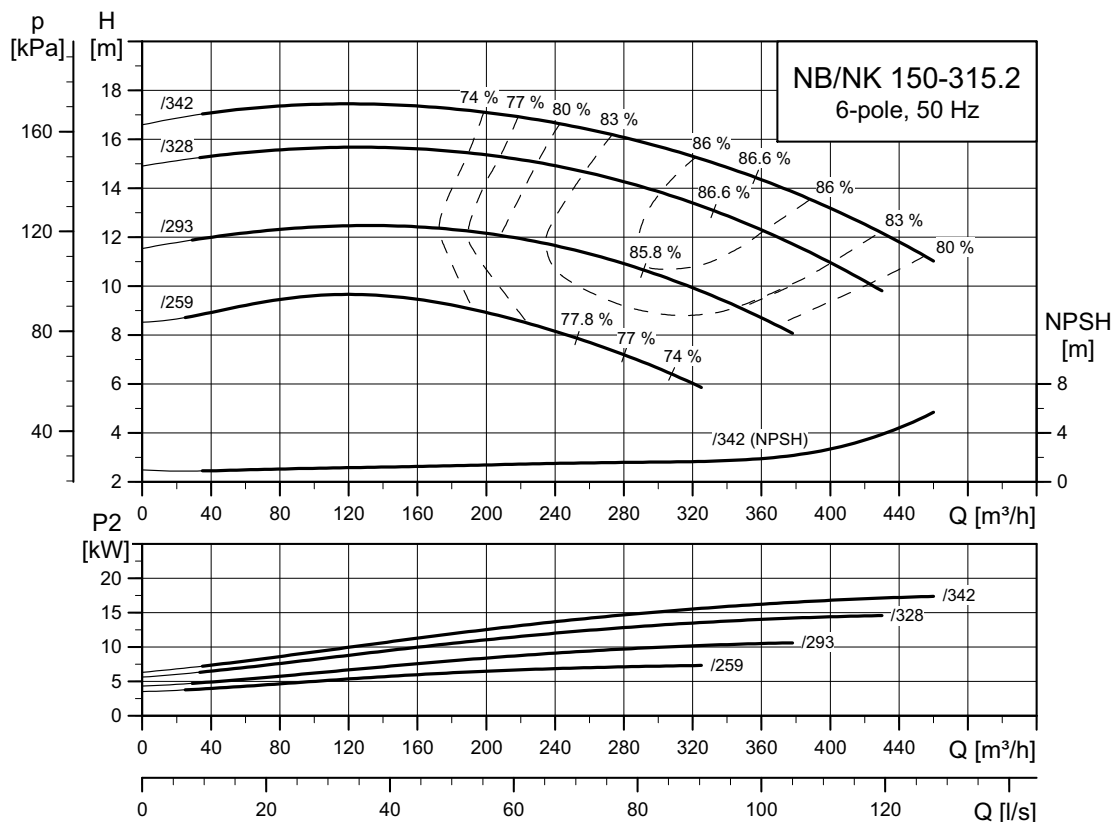

TM06 4572 3315

NB, NK 150-315

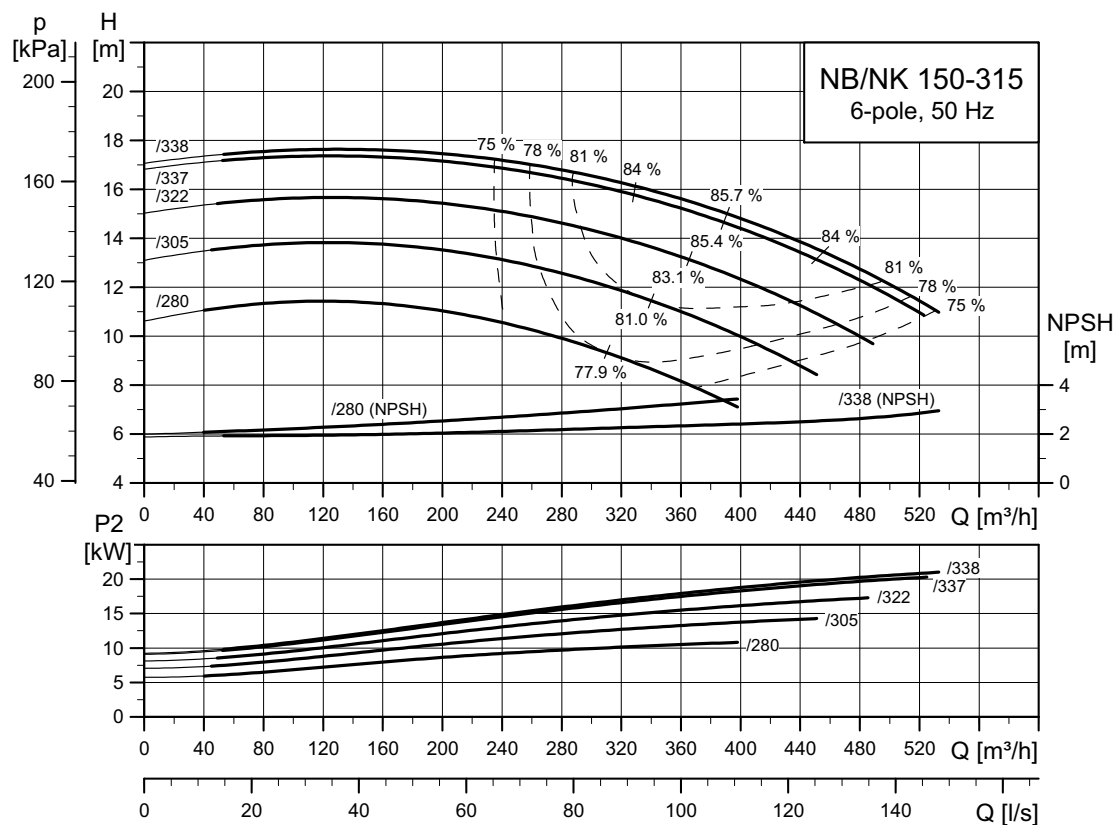

TM03 5171 3414

NB, NK 150-400

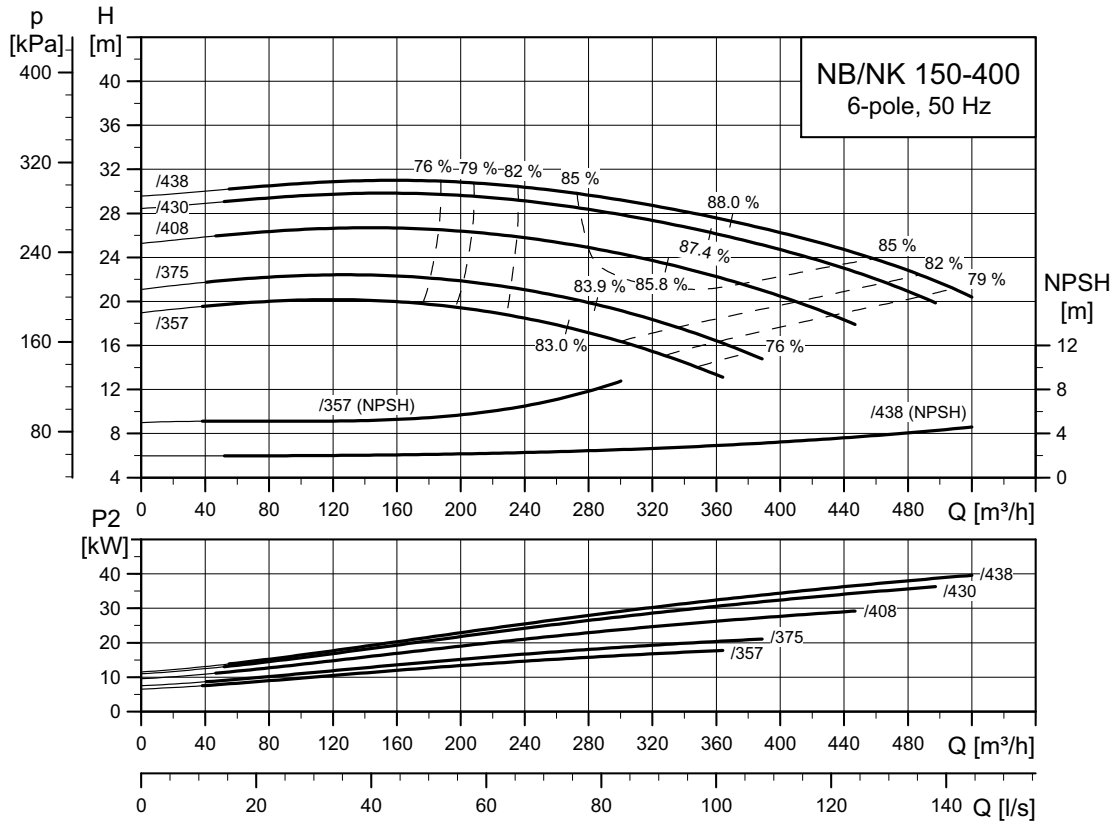

TM03 5172 3414

NB, NK 150-500

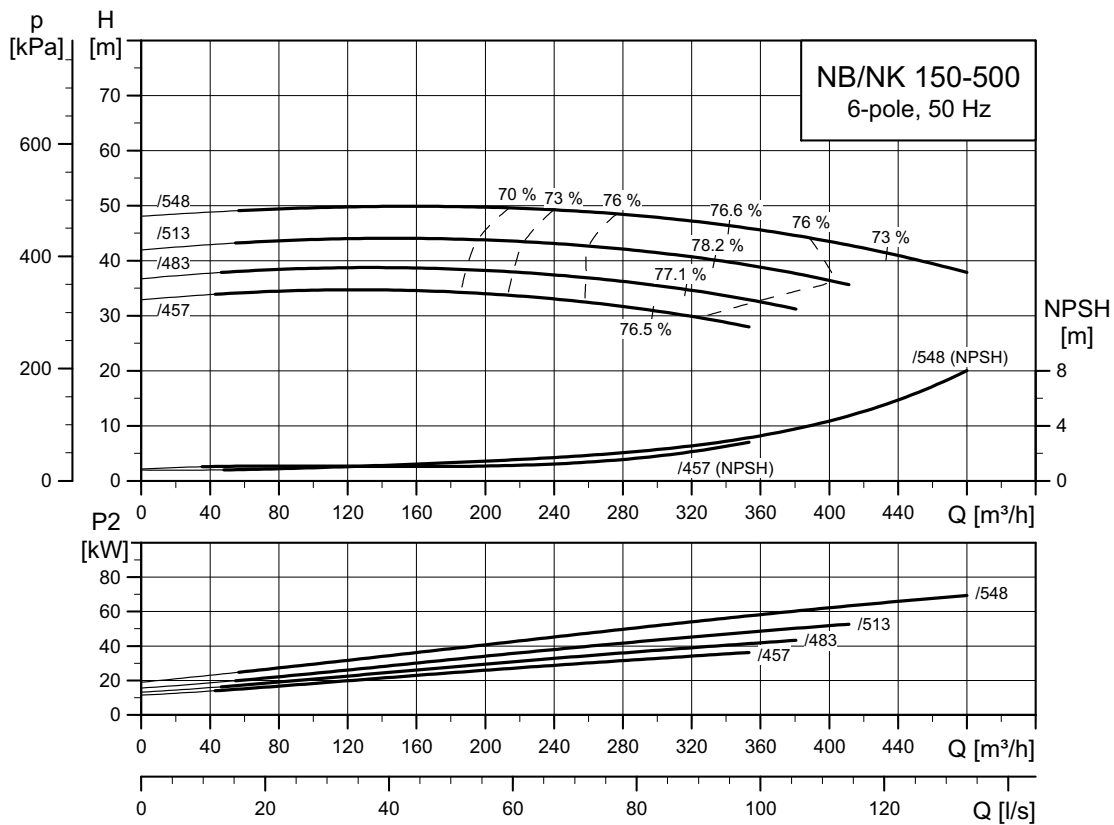

TM03 5173 3414

NB, NK 200-400

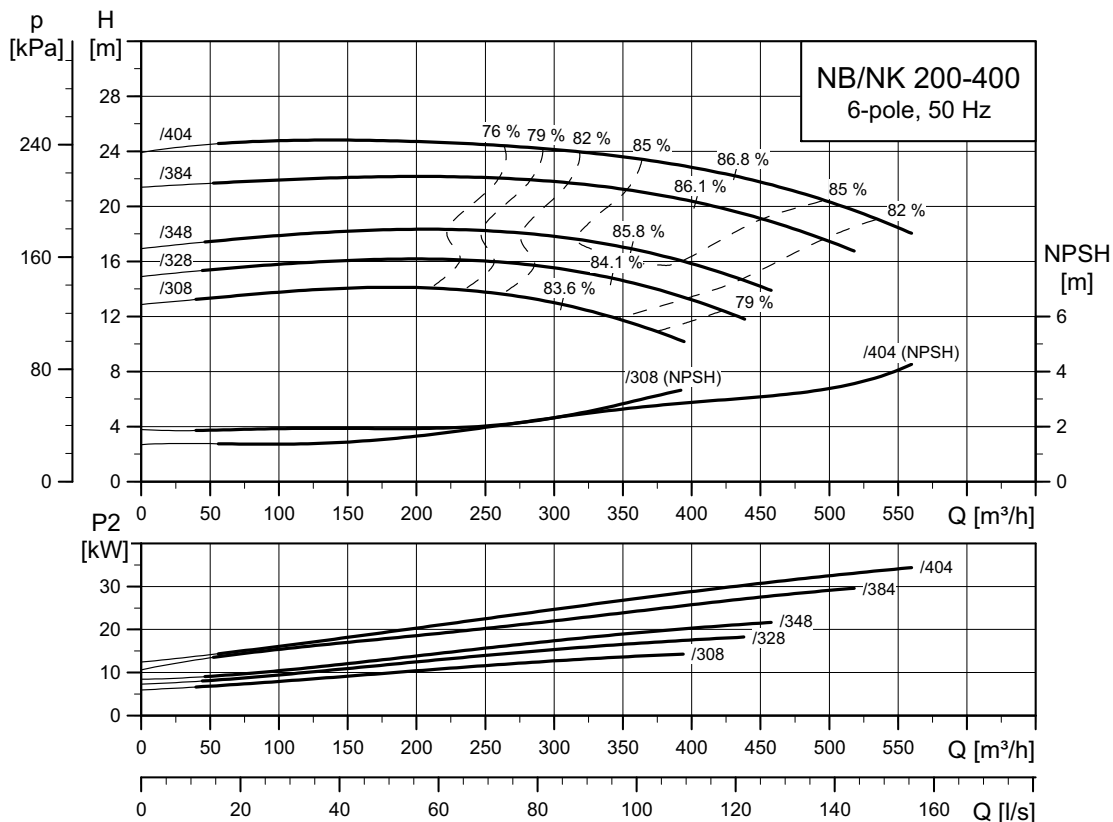

TM04 4936 3414

NB, NK 200-450

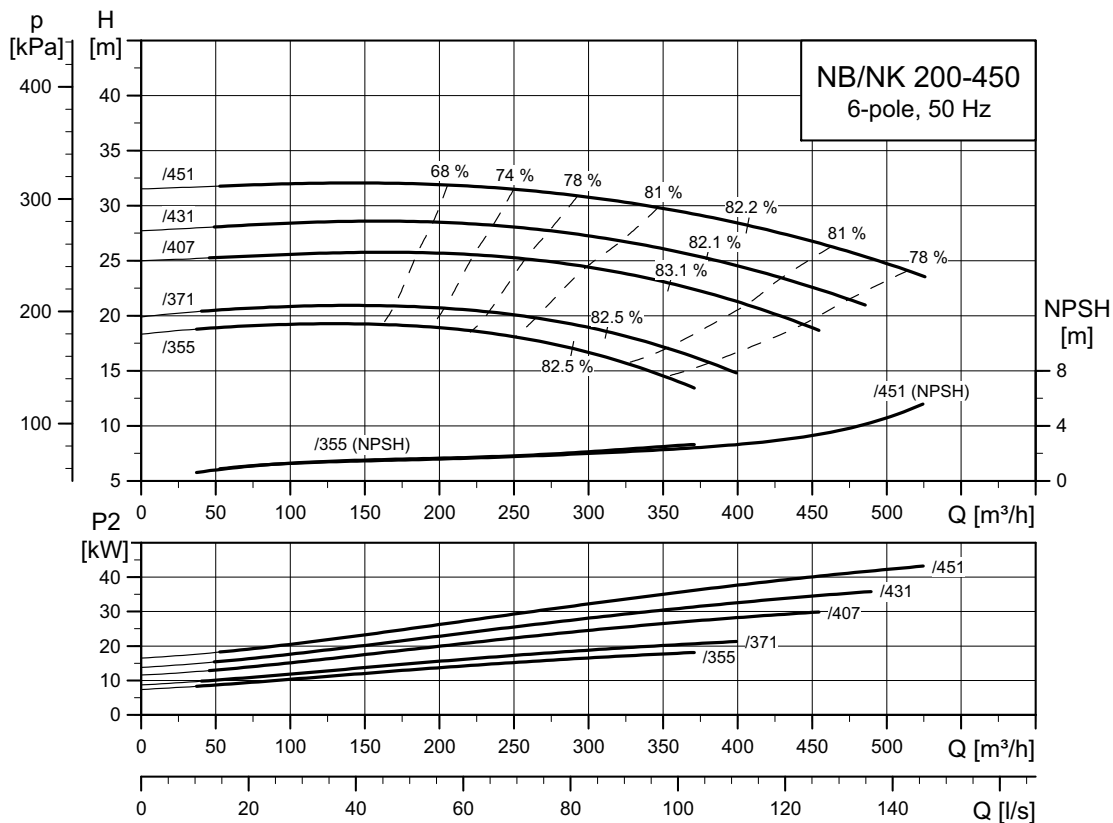

TM04 3968 3414

NB, NK 250-350

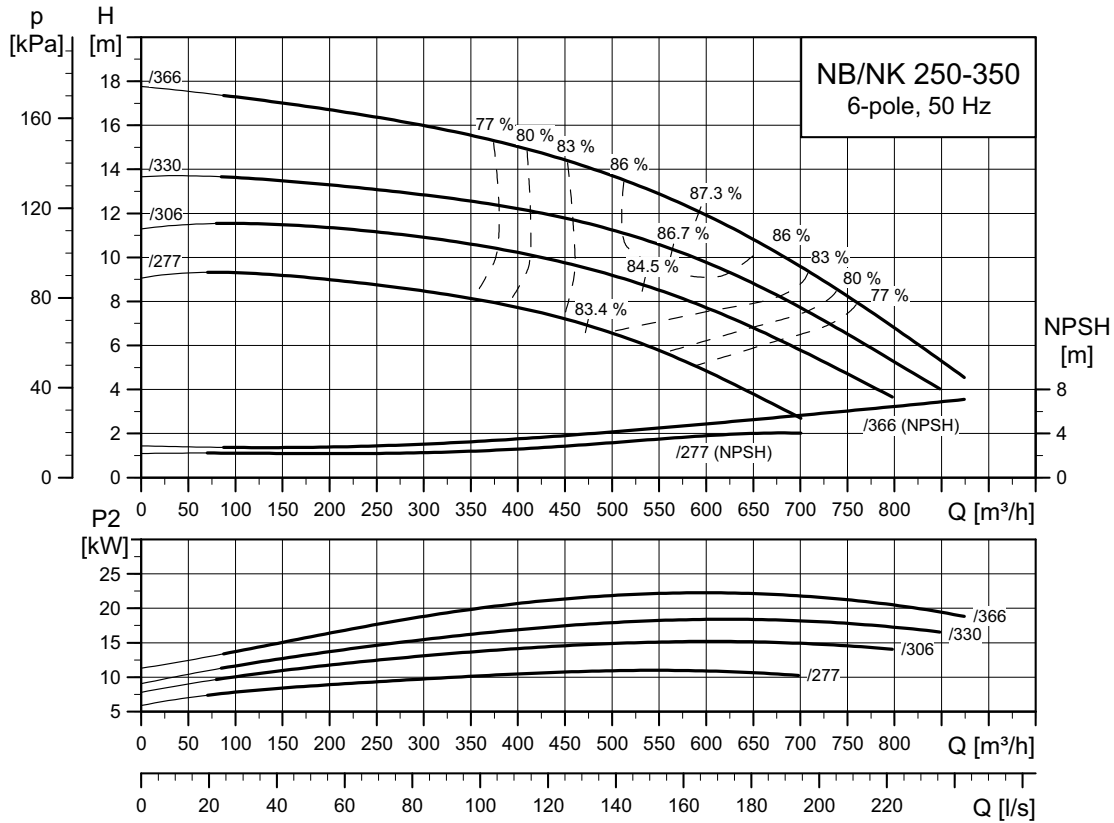

TM04 5998 3414

NB, NK 250-400

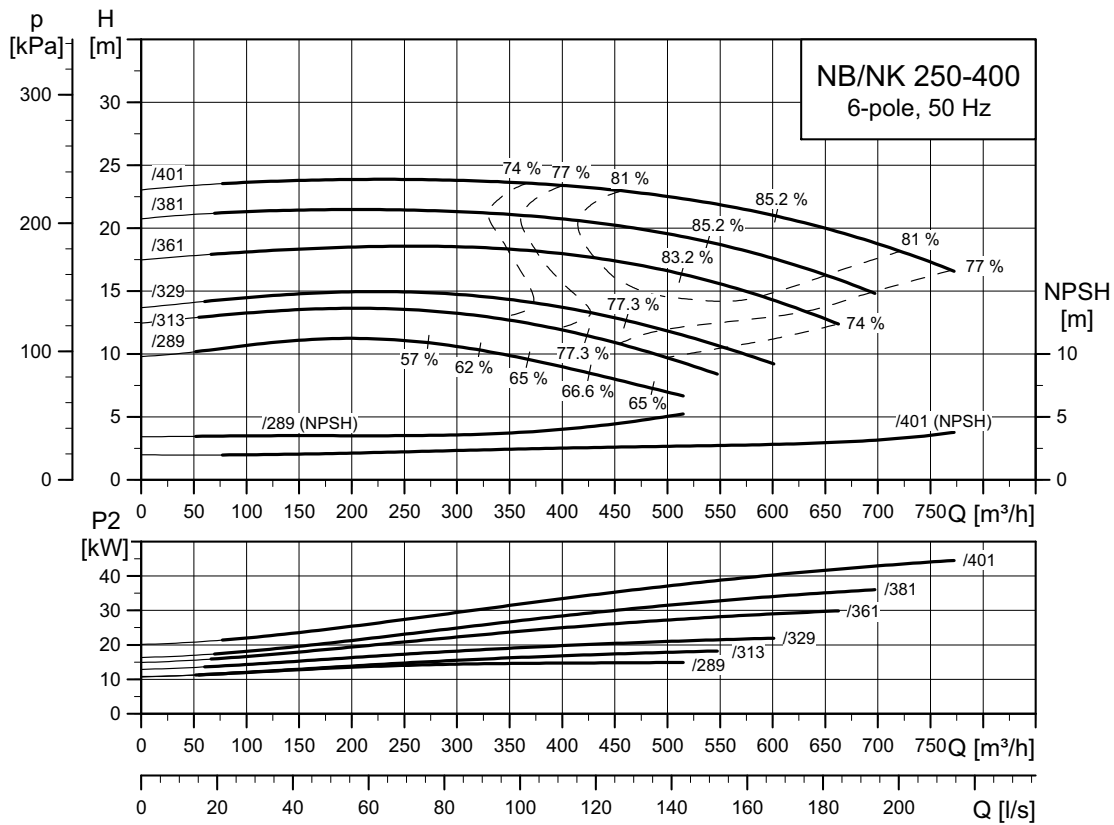

TM04 4023 3414

NB, NK 250-450

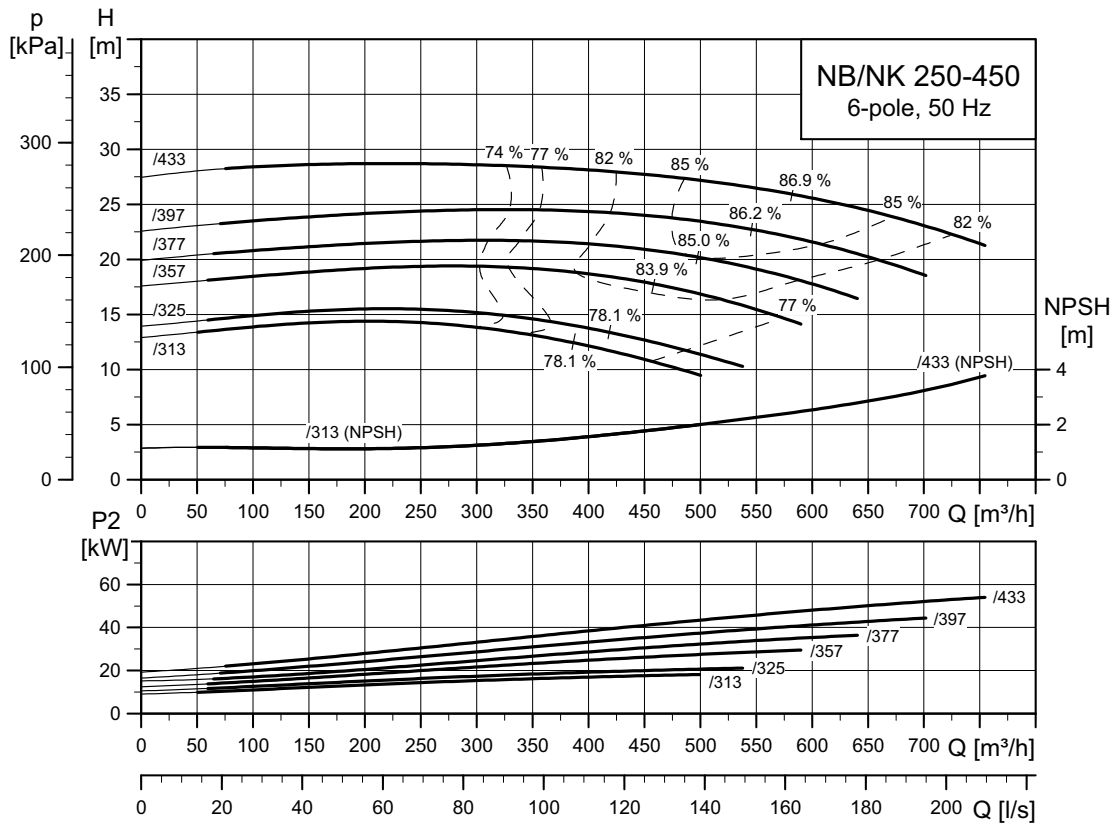

TM04 4940 3414

NB, NK 250-500

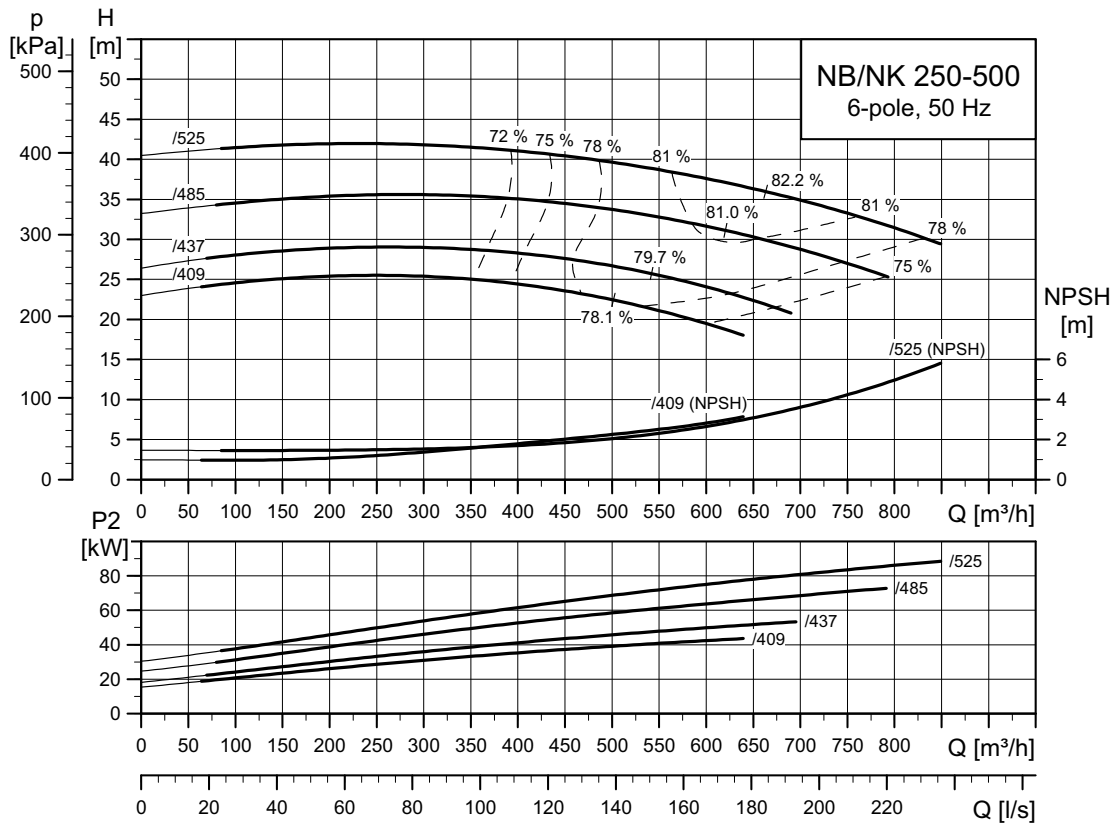

TM04 6002 34 14

17. Dimensional drawings and technical data

Dimensional drawings, NB

Mounting design A

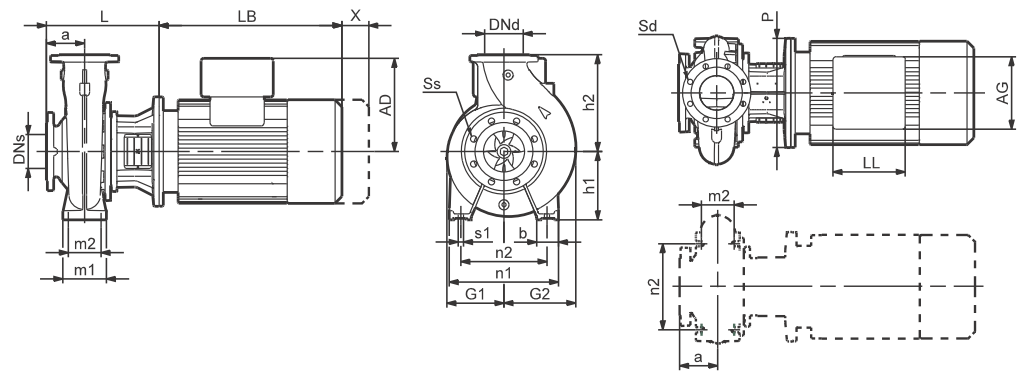

TM03 4180 2415

Mounting design B

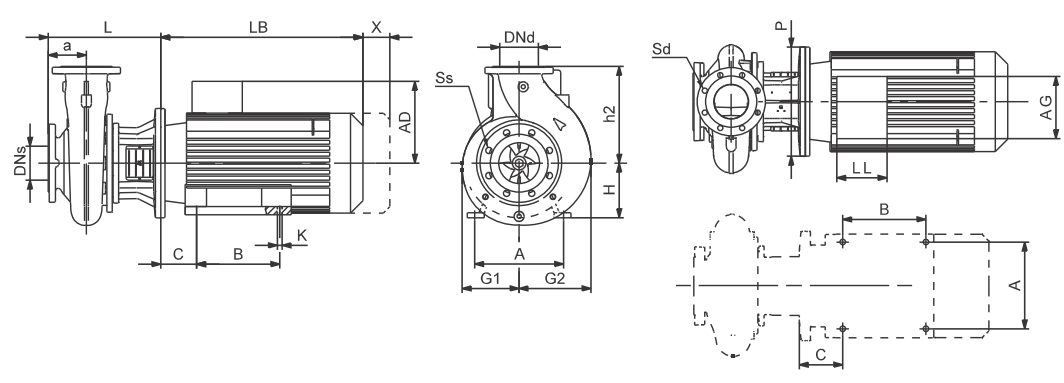

TM03 4181 2415

Mounting design C1, centre outlet

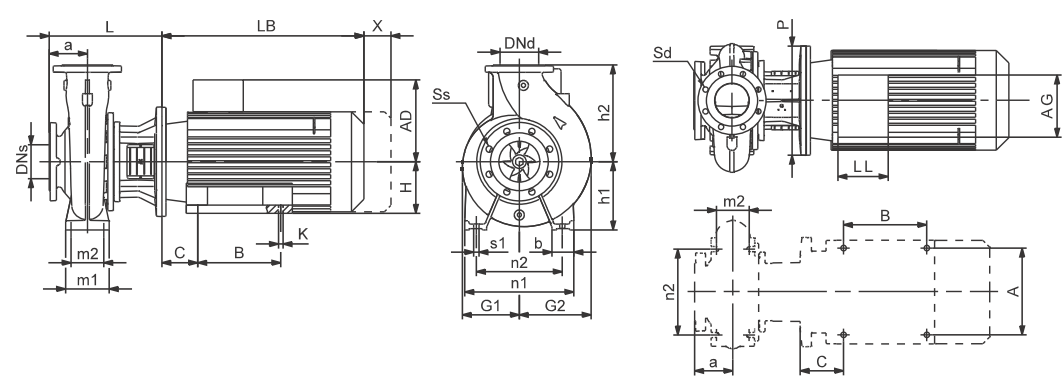

TM03 4182 2415

Mounting design C2, tangential outlet

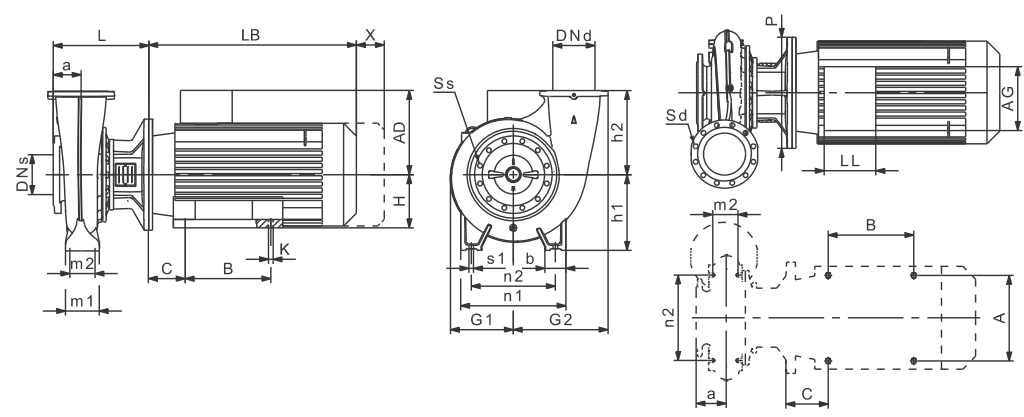

TM05 1432 2415

Technical data, NB

Standard motors in this table are IE3 motors:

- 2-pole: P2 less than or equal to 22 kW, pump with MG motor; P2 greater than or equal to 30 kW, pump with Siemens motor.
- 4-pole: P2 less than or equal to 15 kW, pump with MG motor; P2 greater than or equal to 18.5 kW, pump with Siemens motor.
- 6-pole: Pump with Siemens motor.

E-motors in this table:

- 2-pole: P2 less than or equal to 22 kW, pump with MGE motor.
- 4-pole: P2 less than or equal to 18.5 kW, pump with MGE motor.

Pump size	Poles	P2 [kW]	Actual impeller size	Mounting design	Flanges		NB dimensions [mm]																										
					PN	DNs	DNd	Ss	Sd	a	A	AD ¹	AG ¹	b	B	C	h1	h2	H	G1	G2	K	L		LB ¹	LL ¹	m1	m2	n1	n2	P	s1	X ²
																							CI	SS									
32-125.1	2	0.75	100	A	16	50	32	4x19	4x19	80	-	109/-	82/-	50	-	-	112	140	-	117	117	-	226	226	231/-	82/-	100	70	190	140	200	12	100
		1.1	110	A	16	50	32	4x19	4x19	80	-	109/158	82/268	50	-	-	112	140	-	117	117	-	226	226	251/274	82/232	100	70	190	140	200	12	100
		1.5	121	A	16	50	32	4x19	4x19	80	-	106/181	166/181	50	-	-	112	140	-	117	117	-	226	226	234/274	131/260	100	70	190	140	200	12	100
	4	0.25	140	A	16	50	32	4x19	4x19	80	-	109/-	82/-	50	-	-	112	140	-	117	117	-	201	201	191/-	82/-	100	70	190	140	160	12	100
		0.25	139	A	16	50	32	4x19	4x19	80	-	109/-	82/-	50	-	-	112	140	-	117	117	-	201	201	191/-	82/-	100	70	190	140	160	12	100
		0.37	140	A	16	50	32	4x19	4x19	80	-	109/-	82/-	50	-	-	112	140	-	117	117	-	201	201	191/-	82/-	100	70	190	140	160	12	100
32-125	2	1.1	106	A	16	50	32	4x19	4x19	80	-	109/158	82/268	50	-	-	112	140	-	117	117	-	226	226	251/274	82/232	100	70	190	140	200	12	100
		1.5	115	A	16	50	32	4x19	4x19	80	-	106/181	166/181	50	-	-	112	140	-	117	117	-	226	226	234/274	131/260	100	70	190	140	200	12	100
		2.2	130	A	16	50	32	4x19	4x19	80	-	106/181	166/181	50	-	-	112	140	-	117	117	-	226	226	274/261	131/260	100	70	190	140	200	12	100
	4	0.25	115	A	16	50	32	4x19	4x19	80	-	109/-	82/-	50	-	-	112	140	-	117	117	-	201	201	191/-	82/-	100	70	190	140	160	12	100
		0.25	130	A	16	50	32	4x19	4x19	80	-	109/-	82/-	50	-	-	112	140	-	117	117	-	201	201	191/-	82/-	100	70	190	140	160	12	100
		0.37	142	A	16	50	32	4x19	4x19	80	-	109/-	82/-	50	-	-	112	140	-	117	117	-	201	201	191/-	82/-	100	70	190	140	160	12	100
32-160.1	2	1.5	139	A	16	50	32	4x19	4x19	80	-	106/181	166/181	50	-	-	132	160	-	117	123	-	226	226	234/274	131/260	100	70	240	190	200	12	100
		2.2	155	A	16	50	32	4x19	4x19	80	-	106/181	166/181	50	-	-	132	160	-	117	123	-	226	226	274/261	131/260	100	70	240	190	200	12	100
		3	169	A	16	50	32	4x19	4x19	80	-	120/201	162/222	50	-	-	132	160	-	117	123	-	254	254	335/334	103/280	100	70	240	190	250	12	100
	4	4	177	A	16	50	32	4x19	4x19	80	-	134/201	202/208	50	-	-	132	160	-	117	123	-	254	254	372/334	103/280	100	70	240	190	250	12	100
		0.25	137	A	16	50	32	4x19	4x19	80	-	109/-	82/-	50	-	-	132	160	-	117	123	-	201	201	191/-	82/-	100	70	240	190	160	12	100
		0.25	155	A	16	50	32	4x19	4x19	80	-	109/-	82/-	50	-	-	132	160	-	117	123	-	201	201	191/-	82/-	100	70	240	190	160	12	100
32-160	2	0.37	172	A	16	50	32	4x19	4x19	80	-	109/-	82/-	50	-	-	132	160	-	117	123	-	201	201	191/-	82/-	100	70	240	190	160	12	100
		0.55	177	A	16	50	32	4x19	4x19	80	-	109/158	82/268	50	-	-	132	160	-	117	123	-	226	226	231/274	82/232	100	70	240	190	200	12	100
		2.2	139	A	16	50	32	4x19	4x19	80	-	106/181	166/181	50	-	-	132	160	-	117	125	-	226	226	274/261	131/260	100	70	240	190	200	12	100
	4	3	151	A	16	50	32	4x19	4x19	80	-	120/201	162/222	50	-	-	132	160	-	117	125	-	254	254	335/334	103/280	100	70	240	190	250	12	100
		4	163	A	16	50	32	4x19	4x19	80	-	134/201	202/208	50	-	-	132	160	-	117	125	-	254	254	372/334	103/280	100	70	240	190	250	12	100
		5.5	177	A	16	50	32	4x19	4x19	80	-	134/201	202/228	50	-	-	132	160	-	117	125	-	293	293	391/365	103/280	100	70	240	190	300	12	100
32-200.1	2	0.25	138	A	16	50	32	4x19	4x19	80	-	109/-	82/-	50	-	-	132	160	-	117	125	-	201	201	191/-	82/-	100	70	240	190	160	12	100
		0.37	154	A	16	50	32	4x19	4x19	80	-	109/-	82/-	50	-	-	132	160	-	117	125	-	201	201	191/-	82/-	100	70	240	190	160	12	100
		0.55	172	A	16	50	32	4x19	4x19	80	-	109/158	82/268	50	-	-	132	160	-	117	125	-	226	226	231/274	82/232	100	70	240	190	200	12	100
	4	0.75	173	A	16	50	32	4x19	4x19	80	-	106/174	166/261	50	-	-	132	160	-	117	125	-	226	226	234/312	131/281	100	70	240	190	200	12	100
		3	172	A	16	50	32	4x19	4x19	80	-	120/201	162/222	50	-	-	160	180	-	135	137	-	254	254	335/334	103/280	100	70	240	190	250	12	100
		4	188	A	16	50	32	4x19	4x19	80	-	134/201	202/208	50	-	-	160	180	-	135	137	-	254	254	372/334	103/280	100	70	240	190	250	12	100
32-200	2	5.5	205	A	16	50	32	4x19	4x19	80	-	134/201	202/228	50	-	-	160	180	-	135	137	-	293	293	391/365	103/280	100	70	240	190	300	12	100
		7.5	207	A	16	50	32	4x19	4x19	80	-	159/237	203/227	50	-	-	160	180	-	135	137	-	293	293	379/389	135/317	100	70	240	190	300	12	100
		0.37	175	A	16	50	32	4x19	4x19	80	-	109/-	82/-	50	-	-	160	180	-	135	137	-	243	243	191/-	82/-	100	70	240	190	160	12	100
	4	0.55	196	A	16	50	32	4x19	4x19	80	-	109/158	82/268	50	-	-	160	180	-	135	137	-	226	226	231/274	82/232	100	70	240	190	200	12	100
		0.75	207	A	16	50	32	4x19	4x19	80	-	106/174	166/261	50	-	-	160	180	-	135	137	-	226	226	234/312	131/281	100	70	240	190	200	12	100
		4	176	A	16	50	32	4x19	4x19	80	-	134/201	202/208	50	-	-	160	180	-	124	145	-	254	254	372/334	103/280	100	70	240	190	250	12	100
32-200	2	5.5	190	A	16	50	32	4x19	4x19	80	-	134/201	202/228	50	-	-	160	180	-	124	145	-	293	293	391/365	103/280	100	70	240	190	300	12	100
		7.5	206	A	16	50	32	4x19	4x19	80	-	159/237	203/227	50	-	-	160	180	-	124	145	-	293	293	379/389	135/317	100	70	240	190	300	12	100
		11	219	C1	16	50	32	4x19	4x19	80	254	204/237	243/420	50	210	108	160	180	160	124	145	15	323	323	471/406	213/317	100	70	240	190	350	12	100
	4	0.55	184	A	1																												

Pump size	Poles	Actual impeller size P2 [kW]	Mounting design	Flanges					NB dimensions [mm]																								
				PN	DNS	DNd	Ss	Sd	a	A	AD ¹	AG ¹	b	B	C	h1	h2	H	G1	G2	K	L		LB ¹	LL ¹	m1	m2	n1	n2	P	s1	X ²	
																						Cl	Ss										
32-250	2	5.5	199	A	16	50	32	4x19	4x19	100	-	134/201	202/228	65	-	-	180	225	-	162	164	-	313	313	391/365	103/280	125	95	320	250	300	12	100
		7.5	219	A	16	50	32	4x19	4x19	100	-	159/237	203/227	65	-	-	180	225	-	162	164	-	313	313	379/389	135/317	125	95	320	250	300	12	100
		11	244	C1	16	50	32	4x19	4x19	100	254	204/237	243/420	65	210	108	180	225	160	162	164	15	343	343	471/406	213/317	125	95	320	250	350	12	100
		15	262	C1	16	50	32	4x19	4x19	100	254	204/308	243/420	65	210	108	180	225	160	162	164	15	343	343	471/471	213/400	125	95	320	250	350	12	100
		0.75	206	A	16	50	32	4x19	4x19	100	-	106/174	166/261	65	-	-	180	225	-	162	164	-	273	273	234/312	131/281	125	95	320	250	200	12	100
	4	1.1	236	A	16	50	32	4x19	4x19	100	-	106/181	166/181	65	-	-	180	225	-	162	164	-	273	273	234/274	131/260	125	95	320	250	200	12	100
		1.5	260	A	16	50	32	4x19	4x19	100	-	110/158	162/177	65	-	-	180	225	-	162	164	-	273	273	321/274	103/232	125	95	320	250	200	12	100
		2.2	262	A	16	50	32	4x19	4x19	100	-	120/201	162/222	65	-	-	180	225	-	162	164	-	293	293	335/334	103/280	125	95	320	250	250	12	100
40-125	2	1.5	105	A	16	65	40	4x19	4x19	80	-	134/201	202/228	50	-	-	112	140	-	117	118	-	226	253	234/274	131/260	100	70	210	160	200	12	100
		2.2	116	A	16	65	40	4x19	4x19	80	-	106/181	166/181	50	-	-	112	140	-	117	118	-	226	253	274/261	131/260	100	70	210	160	200	12	100
	2	3	127	A	16	65	40	4x19	4x19	80	-	120/201	162/222	50	-	-	112	140	-	117	118	-	254	273	335/334	103/280	100	70	210	160	250	12	100
	4	4	139	A	16	65	40	4x19	4x19	80	-	134/201	202/208	50	-	-	112	140	-	117	118	-	254	273	372/334	103/280	100	70	210	160	250	12	100
		5.5	142	A	16	65	40	4x19	4x19	80	-	134/201	202/228	50	-	-	112	140	-	117	118	-	293	293	391/365	103/280	100	70	210	160	200	12	100
		0.25	116	A	16	65	40	4x19	4x19	80	-	109/-	82/-	50	-	-	112	140	-	117	118	-	201	243	191/-	82/-	100	70	210	160	160	12	100
	4	0.37	130	A	16	65	40	4x19	4x19	80	-	109/-	82/-	50	-	-	112	140	-	117	118	-	201	243	191/-	82/-	100	70	210	160	160	12	100
		0.55	142	A	16	65	40	4x19	4x19	80	-	109/158	82/268	50	-	-	112	140	-	117	118	-	226	253	231/274	82/232	100	70	210	160	200	12	100
	4	1.44	144	A	16	65	40	4x19	4x19	80	-	134/201	202/208	50	-	-	132	160	-	117	133	-	254	273	372/334	103/280	100	70	240	190	250	12	100
40-160	2	5.5	158	A	16	65	40	4x19	4x19	80	-	134/201	202/228	50	-	-	132	160	-	117	133	-	293	293	391/365	103/280	100	70	240	190	300	12	100
		7.5	172	A	16	65	40	4x19	4x19	80	-	159/237	203/227	50	-	-	132	160	-	117	133	-	293	293	379/389	135/317	100	70	240	190	300	12	100
		11	177	C1	16	65	40	4x19	4x19	80	254	204/237	243/420	50	210	108	132	160	160	117	133	15	323	323	471/406	213/317	100	70	240	190	350	12	100
		0.37	134	A	16	65	40	4x19	4x19	80	-	109/-	82/-	50	-	-	132	160	-	117	133	-	201	243	191/-	82/-	100	70	240	190	160	12	100
	4	0.55	151	A	16	65	40	4x19	4x19	80	-	109/158	82/268	50	-	-	132	160	-	117	133	-	226	253	231/274	82/232	100	70	240	190	200	12	100
		0.75	162	A	16	65	40	4x19	4x19	80	-	106/174	166/261	50	-	-	132	160	-	117	133	-	226	253	234/312	131/281	100	70	240	190	200	12	100
		1.1	177	A	16	65	40	4x19	4x19	80	-	106/181	166/181	50	-	-	132	160	-	117	133	-	226	253	234/274	131/260	100	70	240	190	200	12	100
40-200	2	5.5	172	A	16	65	40	4x19	4x19	100	-	134/201	202/228	50	-	-	160	180	-	140	157	-	313	313	391/365	103/280	100	70	265	212	300	12	100
		7.5	188	A	16	65	40	4x19	4x19	100	-	159/237	203/227	50	-	-	160	180	-	140	157	-	313	313	379/389	135/317	100	70	265	212	300	12	100
		11	206	B	16	65	40	4x19	4x19	100	254	204/237	243/420	-	210	108	-	180	160	140	157	15	343	343	471/406	213/317	-	-	-	-	350	-	100
		15	219	B	16	65	40	4x19	4x19	100	254	204/308	243/420	-	210	108	-	180	160	140	157	15	343	343	471/471	213/400	-	-	-	-	350	-	100
		0.75	177	A	16	65	40	4x19	4x19	100	-	106/174	166/261	50	-	-	160	180	-	140	157	-	246	273	234/312	131/281	100	70	265	212	300	12	100
	4	1.1	198	A	16	65	40	4x19	4x19	100	-	106/181	166/181	50	-	-	160	180	-	140	157	-	246	273	234/274	131/260	100	70	265	212	200	12	100
		1.5	217	A	16	65	40	4x19	4x19	100	-	110/158	162/177	50	-	-	160	180	-	140	157	-	246	273	321/274	103/232	100	70	265	212	200	12	100
		2.2	219	A	16	65	40	4x19	4x19	100	-	120/201	162/222	50	-	-	160	180	-	140	157	-	274	293	335/334	103/280	100	70	265	212	250	12	100
40-250	2	11	211	B	16	65	40	4x19	4x19	100	254	204/237	243/420	-	210	108	-	225	160	164	172	15	343	343	471/406	213/317	-	-	-	-	350	-	100
		15	230	B	16	65	40	4x19	4x19	100	254	204/308	243/420	-	210	108	-	225	160	164	172	15	343	343	471/471	213/400	-	-	-	-	350	-	100
	2	18.5	245	B	16	65	40	4x19	4x19	100	254	204/308	243/420	-	254	108	-	225	160	164	172	15	343	343	515/515	213/400	-	-	-	-	350	-	100
		22	255	B	16	65	40	4x19	4x19	100	279	204/308	243/420	-	241	121	-	225	180	164	172	15	343	343	541/541	213/400	-	-	-	-	350	-	100
		30	260	B	16	65	40	4x19	4x19	100	318	315/-	265/-	-	305	133	-	225	200	164	172	19	343	343	611/-	197/-	100	70	265	212	250	12	100
	4	1.5	219	A	16	65	40	4x19	4x19	100	-	110/158	162/177	65	-	-	180	225	-	164	172	-	246	273	321/274	103/232	125	95	320	250	200	12	100
		2.2	245	A	16	65	40	4x19	4x19	100	-	120/201	162/222	65	-	-	180	225	-	164	172	-	274	293	335/334	103/280	125	95	320	250	250	12	100
		3	260	A	16	65	40	4x19	4x19	100	-	120/201	162/222	65	-	-	180	225	-	164	172	-	274	293	335/334	103/280	125	95	320	250	250	12	100
40-315	2	22	273	C1	16	65	40	4x19	4x19	125	279	204/308	243/420	65	241	121	200	250	180	200	206	15	398	398	541/541	213/400	125	95	345	280	350	12	140
		30	298	C1	16	65	40	4x19	4x19	125	318	315/-	265/-	65	305	133	200	250	200	200	206	19	398	398	611/-	197/-	125	95	345	280	400	12	140
		37	318	C1	16	65	40	4x19	4x19	125	318	315/-	265/-	65	305	133	200	250	200	200	206	19	398	398	636/-	197/-	125	95	345	280	400	12	140
		45	336	C1	16	65	40	4x19	4x19	125	356	338/-	266/-	65	286	149	200	250	225	200	206	19	428	428	708/-	197/-	125	95	345	280	450	12	140
	4	3	283	A	16	65	40	4x19	4x19	125	-	120/201	162/222	65	-	-	200	250	-														

Pump size	Poles	P2 [kW]	Actual impeller size	Mounting design	Flanges					NB dimensions [mm]																							
					PN	DN5	DNd	Ss	Sd	a	A	AD ¹	AG ¹	b	B	C	h1	h2	H	G1	G2	K	L		LB ¹	LL ¹	m1	m2	n1	n2	P	s1	X ²
																							Cl	SS									
50-200	2	11 181	B	16 65 50 4x19 4x19	100 254 204/237 243/420	- 210 108	- 200 160 141 162 15	343 343	471/406 213/317	- - - - 350	- 100																						
		15 198	B	16 65 50 4x19 4x19	100 254 204/308 243/420	- 210 108	- 200 160 141 162 15	343 343	471/471 213/400	- - - - 350	- 100																						
		18.5 210	B	16 65 50 4x19 4x19	100 254 204/308 243/420	- 254 108	- 200 160 141 162 15	343 343	515/515 213/400	- - - - 350	- 100																						
		22 219	B	16 65 50 4x19 4x19	100 279 204/308 243/420	- 241 121	- 200 180 141 162 15	343 343	541/541 213/400	- - - - 350	- 100																						
	4	1.1 171	A	16 65 50 4x19 4x19	100 - 106/181 166/181	50 - -	- 160 200 - 141 162 -	246 273	234/274 131/260	100 70 265 212 200 12	100																						
		1.5 188	A	16 65 50 4x19 4x19	100 - 110/158 162/177	50 - -	- 160 200 - 141 162 -	246 273	321/274 103/232	100 70 265 212 200 12	100																						
		2.2 210	A	16 65 50 4x19 4x19	100 - 120/201 162/222	50 - -	- 160 200 - 141 162 -	274 293	335/334 103/280	100 70 265 212 250 12	100																						
		3 219	A	16 65 50 4x19 4x19	100 - 120/201 162/222	50 - -	- 160 200 - 141 162 -	274 293	335/334 103/280	100 70 265 212 250 12	100																						
	50-250	2	15 205	B	16 65 50 4x19 4x19	100 254 204/308 243/420	- 210 108	- 225 160 164 180 15	343 343	471/471 213/400	- - - - 350	- 100																					
			18.5 222	B	16 65 50 4x19 4x19	100 254 204/308 243/420	- 254 108	- 225 160 164 180 15	343 343	515/515 213/400	- - - - 350	- 100																					
			22 233	B	16 65 50 4x19 4x19	100 279 204/308 243/420	- 241 121	- 225 180 164 180 15	343 343	541/541 213/400	- - - - 350	- 100																					
			30 254	B	16 65 50 4x19 4x19	100 318 315/- 265/-	- 305 133	- 225 200 164 180 19	343 343	611/- 197/-	- - - - 400	- 100																					
4		27 263	B	16 65 50 4x19 4x19	100 318 315/- 265/-	- 305 133	- 225 200 164 180 19	343 343	636/- 197/-	- - - - 400	- 100																						
		2.2 221	A	16 65 50 4x19 4x19	100 - 120/201 162/222	65 - -	- 180 225 - 164 180 -	274 293	335/334 103/280	125 95 320 250 250 12	100																						
		3 241	A	16 65 50 4x19 4x19	100 - 120/201 162/222	65 - -	- 180 225 - 164 180 -	274 293	335/334 103/280	125 95 320 250 250 12	100																						
		4 263	A	16 65 50 4x19 4x19	100 - 134/201 202/208	65 - -	- 180 225 - 164 180 -	274 293	372/334 103/280	125 95 320 250 250 12	100																						
50-315		2	30 267	C1	16 65 50 4x19 4x19	125 318 315/- 265/-	65 305 133 225 280 200 203 214 19	398 398	611/- 197/-	125 95 345 280 400 12	140																						
			37 285	C1	16 65 50 4x19 4x19	125 318 315/- 265/-	65 305 133 225 280 200 203 214 19	398 398	636/- 197/-	125 95 345 280 400 12	140																						
			45 300	C1	16 65 50 4x19 4x19	125 356 338/- 266/-	65 286 149 225 280 225 203 214 19	428 428	708/- 197/-	125 95 345 280 450 12	140																						
			55 321	C1	16 65 50 4x19 4x19	125 406 410/- 319/-	65 349 168 225 280 250 203 214 24	428 428	747/- 233/-	125 95 345 280 550 12	140																						
	4	4 277	A	16 65 50 4x19 4x19	125 - 134/201 202/208	65 - -	- 160 180 - 203 214 -	348 348	372/334 103/280	125 95 280 212 250 12	140																						
		5.5 303	A	16 65 50 4x19 4x19	125 - 159/237 203/227	65 - -	- 225 280 - 203 214 -	368 368	379/389 135/317	125 95 345 280 300 12	140																						
		7.5 331	A	16 65 50 4x19 4x19	125 - 159/237 203/227	65 - -	- 225 280 - 203 214 -	368 368	429/389 135/317	125 95 345 280 300 12	140																						
		11 344	C1	16 65 50 4x19 4x19	125 254 204/308 243/420	65 210 108 225 280 160 203 214 15	398 398	545/471 213/400	125 95 345 280 350 12	140																							
	65-125	2	4 120-110	A	16 80 65 8x19 4x19	100 - 134/201 202/228	65 - -	- 160 180 - 117 146 -	274 293	372/334 103/280	125 95 280 212 250 12	100																					
			5.5 127	A	16 80 65 8x19 4x19	100 - 134/201 202/228	65 - -	- 160 180 - 117 146 -	313 313	391/365 103/280	125 95 280 212 300 12	100																					
			7.5 137	A	16 80 65 8x19 4x19	100 - 159/237 203/227	65 - -	- 160 180 - 117 146 -	313 313	379/389 135/317	125 95 280 212 300 12	100																					
			11 144	C1	16 80 65 8x19 4x19	100 254 204/237 243/420	65 210 108 160 180 160 117 146 15	343 343	471/406 213/317	125 95 280 212 350 12	100																						
4		0.55 122	A	16 80 65 8x19 4x19	100 - 109/158 82/268	65 - -	- 160 180 - 117 146 -	246 273	231/274 82/232	125 95 280 212 200 12	100																						
		0.75 130	A	16 80 65 8x19 4x19	100 - 106/174 166/261	65 - -	- 160 180 - 117 146 -	246 273	234/312 131/281	125 95 280 212 200 12	100																						
		1.1 144	A	16 80 65 8x19 4x19	100 - 106/181 166/181	65 - -	- 160 180 - 117 146 -	246 273	234/274 131/260	125 95 280 212 200 12	100																						
		7.5 143	A	16 80 65 8x19 4x19	100 - 159/237 203/227	65 - -	- 160 200 - 127 161 -	313 313	379/389 135/317	125 95 280 212 300 12	100																						
65-160		2	11 157	B	16 80 65 8x19 4x19	100 254 204/237 243/420	- 210 108	- 200 160 127 161 15	343 343	471/406 213/317	- - - - 350	- 100																					
			15 173	B	16 80 65 8x19 4x19	100 254 204/308 243/420	- 210 108	- 200 160 127 161 15	343 343	471/471 213/400	- - - - 350	- 100																					
			18.5 177	B	16 80 65 8x19 4x19	100 254 204/308 243/420	- 254 108	- 200 160 127 161 15	343 343	515/515 213/400	- - - - 350	- 100																					
			0.75 135	A	16 80 65 8x19 4x19	100 - 106/174 166/261	65 - -	- 160 200 - 127 161 -	246 273	234/312 131/281	125 95 280 212 200 12	100																					
	4	1.1 149	A	16 80 65 8x19 4x19	100 - 106/181 166/181	65 - -	- 160 200 - 127 161 -	246 273	234/274 131/260	125 95 280 212 200 12	100																						
		1.5 165	A	16 80 65 8x19 4x19	100 - 110/158 162/177	65 - -	- 160 200 - 127 161 -	246 273	321/274 103/232	125 95 280 212 200 12	100																						
		2.2 177	A	16 80 65 8x19 4x19	100 - 120/201 162/222	65 - -	- 160 200 - 127 161 -	274 293	335/334 103/280	125 95 280 212 250 12	100																						
		11 162	B	16 80 65 8x19 4x19	100 254 204/237 243/420	- 210 108	- 225 160 149 173 15	343 343	471/406 213/317	- - - - 350	- 140																						
	65-200	2	15 177	B	16 80 65 8x19 4x19	100 254 204/308 243/420	- 210 108	- 225 160 149 173 15	343 343	471/471 213/400	- - - - 350	- 140																					
			18.5 190	B	16 80 65 8x19 4x19	100 254 204/308 243/420	- 254 108	- 225 160 149 173 15	343 343	515/515 213/400	- - - - 350	- 140																					
			22 198	B	16 80 65 8x19 4x19	100 279 204/308 243/420	- 241 121	- 225 180 149 173 15	343 343	541/541 213/400	- - - - 350	- 140																					
			30 217	B	16 80 65 8x19 4x19	100 318 315/- 265/-	- 305 133	- 225 200 149 173 19	343 343	611/- 197/-	- - - - 400	- 140																					
4		37 219	B	16 80 65 8x19 4x19	100 318 315/- 265/-	- 305 133	- 225 200 149 173 19	343 343	636/- 197/-	- - - - 400	- 140																						
		1.5 170	A	16 80 65 8x19 4x19	100 - 110/158 162/177	65 - -	- 180 225 - 149 173 -	273 273	321/274 103/232	125 95 320 250 200 12	140																						
		2.2 189	A	16 80 65 8x19 4x19	100 - 120/201 162/222	65 - -	- 180 225 - 149 173 -	303 293	335/334 103/280	125 95 320 250 250 12	140																						
		3 205	A	16 80 65 8x19 4x19	100 - 120/201 162/222	65 - -	- 180 225 - 149 173 -	303 293	335/334 103/280	125 95 320 250 250 12	140																						
65-250		2	4 219	A	16 80 65 8x19 4x19	100 - 134/201 202/208	65 - -	- 180 225 - 149 173 -	303 293	372/334 103/280	125 95 320 250 250 12	140																					
			30 223	C1	16 80 65 8x19 4x19	100 318 315/- 265/-	80 305 133 200 250 200 183 200 19	373 373	611/- 197/-	160 120 360 280 400 16	140																						
			37 238	C1	16 80 65 8x19 4x19	100 318 315/- 265/-	80 305 133 200 250 200 183 200 19	373 373	636/- 197/-	160 120 360 280 400 16	140																						
			45 251	C1	16 80 65 8x19 4x19	100 356 338/- 266/-	80 286 149 200 250 225 183 200 19	403 403	708/- 197/-	160 120 360 280 450 16	140																						
	4	55 269	C1	16 80 65 8x19 4x19	100 406 410/- 319/-	80 349 168 200 250 250 183 200 24	403 403	747/- 233/-	160 120 360 280 550 16	140																							
		75 270	C1	16 80 65 8x19 4x19	100 457 433/- 319/-	80 368 190 200 250 280 183 200 24	403 403	820/- 233/-	160 120 360 280 550 16	140																							
		3 215	A	16 80 65 8x19 4x19	100 - 120/201 162/222	80 - -	- 200 250 - 183 200 -	323 323	335/334 103/280	160 120 360 280 250 16	140																						
		4 234	A	16 80 65 8x19 4x19	100 - 134/201 202/208	80 - -	- 200 250 - 183 200 -	323 323	372/334 103/280	160 120 360 280 250 16	140																						
	65-315	2	5.5 252	A	16 80 65 8x19 4x19	100 - 159/237 203/227	80 - -	- 200 250 - 183 200 -	343 343	379/389 135/317	160 120 360 280 300 16	140																					
			7.5 270	A	16 80 65 8x19 4x19	100 - 159/237 203/227	80 - -	- 200 250 - 183 200 -	343 343	429/389 135/317	160 120 360 280 300 16	140																					
			55 272	C1	16 80 65 8x19 4x19	125 406 410/- 319/-	80 349 168 225 280 250 211 219 24	428 428	747/- 233/-	160 120 400 315 550 16	140																						
			75 295	C1	16 80 65 8x19 4x19	125 457 433/- 319/-	80 368 190 225 280 280 211 219 24	428 428	820/- 233/-	160 120 400 315 550 16	140																						
4		90 308	C1	16 80 65 8x19 4x19	125 457 433/- 319/-	80 368 190 225 280 280 211 219 24	428 428	930/- 233/-	160 120 400 315 550 16	140																							
		110 320	C1	16 80 65 8x19 4x19	125 508 515/- 374/-	80 406 216 225 280 315 211 219 28	458 458	912/- 299/-	160 120 400 315 660 16	140																							
		5.5 261	A	16 80 65 8x19 4x19	125 - 159/237 203/227	80 - -	- 225 280 - 211 219 -	368 368	379/389 135/317	160 120 400 315 300 16	140																						
		7.5 282	A	16 80 65 8x19 4x19	125 - 159/237 203/227	80 - -	- 225 280 - 211 219 -	368 368	429/389 135/317	160 120 400 315 300 16	140																						
4		11 314	C1	16 80 65 8x19 4x19	125 254 204/308 243/420	80 21																											

Pump size	Poles	P ₂ [kW]	Actual impeller size	Mounting design	Flanges		NB dimensions [mm]																																																																																																																																																																																																																																																																																																																																																																																																																																																																																																																																																																																																																																						
					PN	DNS	DND	Ss	Sd	a	A	AD ¹	AG ¹	b	B	C	h1	h2	H	G1	G2	K	L		LB ¹	LL ¹	m1	m2	n1	n2	P	s1	X ²																																																																																																																																																																																																																																																																																																																																																																																																																																																																																																																																																																																																												
																							Cl	Ss																																																																																																																																																																																																																																																																																																																																																																																																																																																																																																																																																																																																																					
80-160	2	11 147-127	B	16 100 80 8x19 8x19	125 254 204/237 243/420	- 210 108	- 225 160 139 182 15	368 368	471/406 213/317	- - - - 350	- 140	2	15 151	B	16 100 80 8x19 8x19	125 254 204/308 243/420	- 210 108	- 225 160 139 182 15	368 368	471/471 213/400	- - - - 350	- 140	2	18.5 161	B	16 100 80 8x19 8x19	125 254 204/308 243/420	- 254 108	- 225 160 139 182 15	368 368	515/515 213/400	- - - - 350	- 140	2	22 167	B	16 100 80 8x19 8x19	125 279 204/308 243/420	- 241 121	- 225 180 139 182 15	368 368	541/541 213/400	- - - - 350	- 140	2	30 177	B	16 100 80 8x19 8x19	125 318 315/- 265/-	- 305 133	- 225 200 139 182 19	368 368	611/- 197/-	- - - - 400	- 140	4	1.5 146	A	16 100 80 8x19 8x19	125 - 110/158 162/177	65 - - 180 225 - 139 182 -	271 298	321/274 103/232	125 95 320 250 200 12	140	4	2.2 161	A	16 100 80 8x19 8x19	125 - 120/201 162/222	65 - - 180 225 - 139 182 -	299 318	335/334 103/280	125 95 320 250 250 12	140	4	3 175	A	16 100 80 8x19 8x19	125 - 120/201 162/222	65 - - 180 225 - 139 182 -	299 318	335/334 103/280	125 95 320 250 250 12	140	4	4 177	A	16 100 80 8x19 8x19	125 - 134/201 202/208	65 - - 180 225 - 139 182 -	299 318	372/334 103/280	125 95 320 250 250 12	140	2	22 171	C1	16 100 80 8x19 8x19	125 279 204/308 243/420	65 241 121 180 250 180 160 193 15	398 398	541/541 213/400	125 95 345 280 350 12	140	2	30 188	C1	16 100 80 8x19 8x19	125 318 315/- 265/-	65 305 133 180 250 200 160 193 19	398 398	611/- 197/-	125 95 345 280 400 12	140	80-200	2	37 200	C1	16 100 80 8x19 8x19	125 318 315/- 265/-	65 305 133 180 250 200 160 193 19	398 398	636/- 197/-	125 95 345 280 400 12	140	2	45 211	C1	16 100 80 8x19 8x19	125 356 338/- 266/-	65 286 149 180 250 225 160 193 19	428 428	708/- 197/-	125 95 345 280 450 12	140	2	55 222	C1	16 100 80 8x19 8x19	125 406 410/- 319/-	65 349 168 180 250 250 160 193 24	428 428	747/- 233/-	125 95 345 280 550 12	140	2	2.2 164	A	16 100 80 8x19 8x19	125 - 120/201 162/222	65 - - 180 250 - 160 193 -	348 348	335/334 103/280	125 95 345 280 250 12	140	4	3 179	A	16 100 80 8x19 8x19	125 - 120/201 162/222	65 - - 180 250 - 160 193 -	348 348	335/334 103/280	125 95 345 280 250 12	140	4	4 196	A	16 100 80 8x19 8x19	125 - 134/201 202/208	65 - - 180 250 - 160 193 -	348 348	372/334 103/280	125 95 345 280 250 12	140	2	5.5 214	A	16 100 80 8x19 8x19	125 - 159/237 203/227	65 - - 180 250 - 160 193 -	368 368	379/389 135/317	125 95 345 280 300 12	140	2	7.5 222	A	16 100 80 8x19 8x19	125 - 159/237 203/227	65 - - 180 250 - 160 193 -	368 368	429/389 135/317	125 95 345 280 300 12	140	80-250	2	45 220	C1	16 100 80 8x19 8x19	125 356 338/- 266/-	80 286 149 200 280 225 182 210 19	428 428	708/- 197/-	160 120 400 315 450 16	140	2	55 234	C1	16 100 80 8x19 8x19	125 406 410/- 319/-	80 349 168 200 280 250 182 210 24	428 428	747/- 233/-	160 120 400 315 550 16	140	2	75 257	C1	16 100 80 8x19 8x19	125 457 433/- 319/-	80 368 190 200 280 280 182 210 24	428 428	820/- 233/-	160 120 400 315 550 16	140	2	90 270	C1	16 100 80 8x19 8x19	125 457 433/- 319/-	80 368 190 200 280 280 182 210 24	428 428	930/- 233/-	160 120 400 315 550 16	140	2	5.5 225	A	16 100 80 8x19 8x19	125 - 159/237 203/227	80 - - 200 280 - 182 210 -	368 368	379/389 135/317	160 120 400 315 300 16	140	2	7.5 247	A	16 100 80 8x19 8x19	125 - 159/237 203/227	80 - - 200 280 - 182 210 -	368 368	429/389 135/317	160 120 400 315 300 16	140	80-315	2	11 270	C1	16 100 80 8x19 8x19	125 254 204/308 243/420	80 210 108 200 280 160 182 210 15	398 398	545/471 213/400	160 120 400 315 350 16	140	2	90 278	C1	16 100 80 8x19 8x19	125 457 433/- 319/-	80 368 190 250 315 280 216 243 24	428 428	930/- 233/-	160 120 400 315 550 16	140	2	110 295	C1	16 100 80 8x19 8x19	125 508 515/- 374/-	80 406 216 250 315 315 216 243 28	458 458	912/- 299/-	160 120 400 315 660 16	140	2	132 310	C1	16 100 80 8x19 8x19	125 508 515/- 374/-	80 457 216 250 315 315 216 243 28	458 458	1077/- 299/-	160 120 400 315 660 16	140	2	160 328	C1	16 100 80 8x19 8x19	125 508 515/- 374/-	80 457 216 250 315 315 216 243 28	458 458	1077/- 299/-	160 120 400 315 660 16	140	2	11 280	C1	16 100 80 8x19 8x19	125 254 204/308 243/420	80 210 108 250 315 160 216 243 15	398 398	545/471 213/400	160 120 400 315 350 16	140	80-400	2	15 305	C1	16 100 80 8x19 8x19	125 254 204/308 243/420	80 254 108 250 315 160 216 243 15	398 398	575/515 213/400	160 120 400 315 350 16	140	2	18.5 320	C1	16 100 80 8x19 8x19	125 279 286/308 189/420	80 241 121 250 315 180 216 243 15	398 398	588/541 164/400	160 120 400 315 350 16	140	2	22 334	C1	16 100 80 8x19 8x19	125 279 286/- 189/-	80 241 121 250 315 180 216 243 15	398 398	588/- 164/-	160 120 400 315 350 16	140	2	18.5 347	C1	16 100 80 8x19 8x19	125 279 286/308 189/420	80 241 121 280 355 180 266 287 15	396 398	588/541 164/400	160 120 435 355 350 16	140	2	22 365	C1	16 100 80 8x19 8x19	125 279 286/- 189/-	80 241 121 280 355 180 266 287 15	396 398	588/- 164/-	160 120 435 355 350 16	140	2	30 397	C1	16 100 80 8x19 8x19	125 318 315/- 265/-	80 305 133 280 355 200 266 287 19	396 398	636/- 197/-	160 120 435 355 400 16	140	2	37 419	C1	16 100 80 8x19 8x19	125 356 338/- 266/-	80 286 149 280 355 225 266 287 19	426 428	648/- 197/-	160 120 435 355 450 16	140	100-160	2	45 438	C1	16 100 80 8x19 8x19	125 356 338/- 266/-	80 286 149 280 355 225 266 287 19	426 428	708/- 197/-	160 120 435 355 450 16	140	2	18.5 160-154	C1	16 125 100 8x19 8x19	125 254 204/308 243/420	80 254 108 200 280 160 146 187 15	368 368	515/515 213/400	160 120 360 280 350 16	140	2	22 167	C1	16 125 100 8x19 8x19	125 279 204/308 243/420	80 241 121 200 280 180 146 187 15	368 368	541/541 213/400	160 120 360 280 350 16	140	2	30 176	C1	16 125 100 8x19 8x19	125 318 315/- 265/-	80 305 133 200 280 200 146 187 19	368 368	611/- 197/-	160 120 360 280 400 16	140	100-200	2	2.2 160-140	A	16 125 100 8x19 8x19	125 - 120/201 162/222	80 - - 200 280 - 146 187 -	318 318	335/334 103/280	160 120 360 280 250 16	140	2	3 169	A	16 125 100 8x19 8x19	125 - 120/201 162/222	80 - - 200 280 - 146 187 -	318 318	335/334 103/280	160 120 360 280 250 16	140	2	4 176	A	16 125 100 8x19 8x19	125 - 134/201 202/208	80 - - 200 280 - 146 187 -	318 318	372/334 103/280	160 120 360 280 250 16	140	2	0.55 160-140	A	16 125 100 8x19 8x19	125 - 120/- 75/-	80 - - 200 280 - 146 187 -	298 298	234/- 75/-	160 120 360 280 200 16	140	6	0.75 169	A	16 125 100 8x19 8x19	125 - 128/- 75/-	80 - - 200 280 - 146 187 -	298 298	281/- 75/-	160 120 360 280 200 16	140	2	1.1 176	A	16 125 100 8x19 8x19	125 - 128/- 75/-	80 - - 200 280 - 146 187 -	298 298	326/- 75/-	160 120 360 280 200 16	140	2	30 170	C1	16 125 100 8x19 8x19	125 318 315/- 265/-	80 305 133 200 280 200 169 212 19	398 398	611/- 197/-	160 120 360 280 400 16	140	2	37 181	C1	16 125 100 8x19 8x19	125 318 315/- 265/-	80 305 133 200 280 200 169 212 19	398 398	636/- 197/-	160 120 360 280 400 16	140	2	45 192	C1	16 125 100 8x19 8x19	125 356 338/- 266/-	80 286 149 200 280 225 169 212 19	428 428	708/- 197/-	160 120 360 280 450 16	140	2	55 203	C1	16 125 100 8x19 8x19	125 406 410/- 319/-	80 349 168 200 280 250 169 212 24	428 428	747/- 233/-	160 120 360 280 550 16	140	2	75 219	C1	16 125 100 8x19 8x19	125 457 433/- 319/-	80 368 190 200 280 280 169 212 24	428 428	820/- 233/-	160 120 360 280 550 16	140	4	4 178	A	16 125 100 8x19 8x19	125 - 134/201 202/208	80 - - 200 280 - 169 212 -	348 348	372/334 103/280	160 120 360 280 250 16	140	4	5.5 195	A	16 125 100 8x19 8x19	125 - 159/237 203/227	80 - - 200 280 - 169 212 -	368 368	379/389 135/317	160 120 360 280 300 16	140	6	7.5 211	A	16 125 100 8x19 8x19	125 - 159/237 203/227	80 - - 200 280 - 169 212 -	368 368	429/389 135/317	160 120 360 280 300 16	140	2	11 219	C1	16 125 100 8x19 8x19	125 254 204/308 243/420	80 210 108 200 280 160 169 212 15	398 398	545/471 213/400	160 120 360 280 350 16	140	2	1.1 182	A	16 125 100 8x19 8x19	125 - 128/- 75/-	80 - - 200 280 - 169 212 -	328 328	326/- 75/-	160 120 360 280 200 16	140	6	1.5 193	A	16 125 100 8x19 8x19	125 - 166/- 135/-	80 - - 200 280 - 169 212 -	348 348	336/- 112/-	160 120 360 280 250 16	140	6	2.2 214	A	16 125 100 8x19 8x19	125 - 177/- 135/-	80 - - 200 280 - 169 212 -	348 348	354/- 112/-	160 120 360 280 250 16	140	6	3 219	A	16 125 100 8x19 8x19	125 - 202/- 155/-	80 - - 200 280 - 169 212 -	368 368	385/- 130/-	160 120 360 280 300 16	140
		80-200	2	37 200	C1	16 100 80 8x19 8x19	125 318 315/- 265/-	65 305 133 180 250 200 160 193 19	398 398	636/- 197/-	125 95 345 280 400 12		140	2	45 211	C1	16 100 80 8x19 8x19	125 356 338/- 266/-	65 286 149 180 250 225 160 193 19	428 428	708/- 197/-	125 95 345 280 450 12		140	2	55 222	C1	16 100 80 8x19 8x19	125 406 410/- 319/-	65 349 168 180 250 250 160 193 24	428 428	747/- 233/-	125 95 345 280 550 12		140	2	2.2 164	A	16 100 80 8x19 8x19	125 - 120/201 162/222	65 - - 180 250 - 160 193 -	348 348	335/334 103/280	125 95 345 280 250 12		140	4	3 179	A	16 100 80 8x19 8x19	125 - 120/201 162/222	65 - - 180 250 - 160 193 -	348 348	335/334 103/280	125 95 345 280 250 12		140	4	4 196	A	16 100 80 8x19 8x19	125 - 134/201 202/208	65 - - 180 250 - 160 193 -	348 348	372/334 103/280		125 95 345 280 250 12	140	2	5.5 214	A	16 100 80 8x19 8x19	125 - 159/237 203/227	65 - - 180 250 - 160 193 -	368 368		379/389 135/317	125 95 345 280 300 12	140	2	7.5 222	A	16 100 80 8x19 8x19	125 - 159/237 203/227	65 - - 180 250 - 160 193 -		368 368	429/389 135/317	125 95 345 280 300 12	140	80-250	2	45 220	C1	16 100 80 8x19 8x19		125 356 338/- 266/-	80 286 149 200 280 225 182 210 19	428 428	708/- 197/-	160 120 400 315 450 16	140	2	55 234	C1		16 100 80 8x19 8x19	125 406 410/- 319/-	80 349 168 200 280 250 182 210 24	428 428	747/- 233/-	160 120 400 315 550 16	140	2	75 257			C1	16 100 80 8x19 8x19	125 457 433/- 319/-	80 368 190 200 280 280 182 210 24	428 428	820/- 233/-	160 120 400 315 550 16	140	2		90 270	C1	16 100 80 8x19 8x19	125 457 433/- 319/-	80 368 190 200 280 280 182 210 24	428 428	930/- 233/-	160 120 400 315 550 16	140		2	5.5 225	A	16 100 80 8x19 8x19	125 - 159/237 203/227	80 - - 200 280 - 182 210 -	368 368	379/389 135/317	160 120 400 315 300 16		140	2	7.5 247	A	16 100 80 8x19 8x19	125 - 159/237 203/227	80 - - 200 280 - 182 210 -	368 368	429/389 135/317		160 120 400 315 300 16	140	80-315	2	11 270	C1	16 100 80 8x19 8x19	125 254 204/308 243/420	80 210 108 200 280 160 182 210 15		398 398	545/471 213/400	160 120 400 315 350 16	140	2	90 278	C1	16 100 80 8x19 8x19	125 457 433/- 319/-		80 368 190 250 315 280 216 243 24	428 428	930/- 233/-	160 120 400 315 550 16	140	2	110 295	C1	16 100 80 8x19 8x19		125 508 515/- 374/-	80 406 216 250 315 315 216 243 28	458 458	912/- 299/-	160 120 400 315 660 16	140	2	132 310	C1			16 100 80 8x19 8x19	125 508 515/- 374/-	80 457 216 250 315 315 216 243 28	458 458	1077/- 299/-	160 120 400 315 660 16	140	2	160 328		C1	16 100 80 8x19 8x19	125 508 515/- 374/-	80 457 216 250 315 315 216 243 28	458 458	1077/- 299/-	160 120 400 315 660 16	140	2		11 280	C1	16 100 80 8x19 8x19	125 254 204/308 243/420	80 210 108 250 315 160 216 243 15	398 398	545/471 213/400	160 120 400 315 350 16	140		80-400	2	15 305	C1	16 100 80 8x19 8x19	125 254 204/308 243/420	80 254 108 250 315 160 216 243 15	398 398	575/515 213/400		160 120 400 315 350 16	140	2	18.5 320	C1	16 100 80 8x19 8x19	125 279 286/308 189/420	80 241 121 250 315 180 216 243 15	398 398		588/541 164/400	160 120 400 315 350 16	140	2	22 334	C1	16 100 80 8x19 8x19	125 279 286/- 189/-	80 241 121 250 315 180 216 243 15			398 398	588/- 164/-	160 120 400 315 350 16	140	2	18.5 347	C1	16 100 80 8x19 8x19	125 279 286/308 189/420		80 241 121 280 355 180 266 287 15	396 398	588/541 164/400	160 120 435 355 350 16	140	2	22 365	C1	16 100 80 8x19 8x19		125 279 286/- 189/-	80 241 121 280 355 180 266 287 15	396 398	588/- 164/-	160 120 435 355 350 16	140	2	30 397	C1		16 100 80 8x19 8x19	125 318 315/- 265/-	80 305 133 280 355 200 266 287 19	396 398	636/- 197/-	160 120 435 355 400 16	140	2	37 419		C1	16 100 80 8x19 8x19	125 356 338/- 266/-	80 286 149 280 355 225 266 287 19	426 428	648/- 197/-	160 120 435 355 450 16	140	100-160		2	45 438	C1	16 100 80 8x19 8x19	125 356 338/- 266/-	80 286 149 280 355 225 266 287 19	426 428	708/- 197/-	160 120 435 355 450 16			140	2	18.5 160-154	C1	16 125 100 8x19 8x19	125 254 204/308 243/420	80 254 108 200 280 160 146 187 15	368 368	515/515 213/400		160 120 360 280 350 16	140	2	22 167	C1	16 125 100 8x19 8x19	125 279 204/308 243/420	80 241 121 200 280 180 146 187 15	368 368		541/541 213/400	160 120 360 280 350 16	140	2	30 176	C1	16 125 100 8x19 8x19	125 318 315/- 265/-	80 305 133 200 280 200 146 187 19		368 368	611/- 197/-	160 120 360 280 400 16	140	100-200	2	2.2 160-140	A	16 125 100 8x19 8x19		125 - 120/201 162/222	80 - - 200 280 - 146 187 -	318 318	335/334 103/280	160 120 360 280 250 16	140	2	3 169	A		16 125 100 8x19 8x19	125 - 120/201 162/222	80 - - 200 280 - 146 187 -	318 318	335/334 103/280	160 120 360 280 250 16	140	2	4 176		A	16 125 100 8x19 8x19	125 - 134/201 202/208	80 - - 200 280 - 146 187 -	318 318	372/334 103/280	160 120 360 280 250 16	140	2			0.55 160-140	A	16 125 100 8x19 8x19	125 - 120/- 75/-	80 - - 200 280 - 146 187 -	298 298	234/- 75/-	160 120 360 280 200 16	140		6	0.75 169	A	16 125 100 8x19 8x19	125 - 128/- 75/-	80 - - 200 280 - 146 187 -	298 298	281/- 75/-	160 120 360 280 200 16		140	2	1.1 176	A	16 125 100 8x19 8x19	125 - 128/- 75/-	80 - - 200 280 - 146 187 -	298 298	326/- 75/-		160 120 360 280 200 16	140	2	30 170	C1	16 125 100 8x19 8x19	125 318 315/- 265/-	80 305 133 200 280 200 169 212 19	398 398			611/- 197/-	160 120 360 280 400 16	140	2	37 181	C1	16 125 100 8x19 8x19	125 318 315/- 265/-	80 305 133 200 280 200 169 212 19		398 398	636/- 197/-	160 120 360 280 400 16	140	2	45 192	C1	16 125 100 8x19 8x19	125 356 338/- 266/-		80 286 149 200 280 225 169 212 19	428 428	708/- 197/-	160 120 360 280 450 16	140	2	55 203	C1	16 125 100 8x19 8x19		125 406 410/- 319/-	80 349 168 200 280 250 169 212 24	428 428	747/- 233/-	160 120 360 280 550 16	140	2	75 219	C1		16 125 100 8x19 8x19	125 457 433/- 319/-	80 368 190 200 280 280 169 212 24	428 428	820/- 233/-	160 120 360 280 550 16	140	4	4 178		A	16 125 100 8x19 8x19	125 - 134/201 202/208	80 - - 200 280 - 169 212 -	348 348	372/334 103/280	160 120 360 280 250 16	140	4		5.5 195	A	16 125 100 8x19 8x19	125 - 159/237 203/227	80 - - 200 280 - 169 212 -	368 368	379/389 135/317	160 120 360 280 300 16	140		6	7.5 211	A	16 125 100 8x19 8x19	125 - 159/237 203/227	80 - - 200 280 - 169 212 -	368 368	429/389 135/317	160 120 360 280 300 16		140	2	11 219	C1	16 125 100 8x19 8x19	125 254 204/308 243/420	80 210 108 200 280 160 169 212 15	398 398	545/471 213/400		160 120 360 280 350 16	140	2	1.1 182	A	16 125 100 8x19 8x19	125 - 128/- 75/-	80 - - 200 280 - 169 212 -	328 328		326/- 75/-	160 120 360 280 200 16	140	6	1.5 193	A	16 125 100 8x19 8x19	125 - 166/- 135/-	80 - - 200 280 - 169 212 -		348 348	336/- 112/-	160 120 360 280 250 16	140	6	2.2 214	A	16 125 100 8x19 8x19	125 - 177/- 135/-		80 - - 200 280 - 169 212 -	348 348	354/- 112/-	160 120 360 280 250 16	140	6	3 219	A	16 125 100 8x19 8x19		125 - 202/- 155/-	80 - - 200 280 - 169 212 -	368 368	385/- 130/-	160 120 360 280 300 16	140																																																					
	80-250			2	45 220	C1	16 100 80 8x19 8x19	125 356 338/- 266/-	80 286 149 200 280 225 182 210 19	428 428	708/- 197/-	160 120 400 315 450 16	140		2	55 234	C1	16 100 80 8x19 8x19	125 406 410/- 319/-	80 349 168 200 280 250 182 210 24	428 428	747/- 233/-	160 120 400 315 550 16	140		2	75 257	C1	16 100 80 8x19 8x19	125 457 433/- 319/-	80 368 190 200 280 280 182 210 24	428 428	820/- 233/-	160 120 400 315 550 16	140		2	90 270	C1	16 100 80 8x19 8x19	125 457 433/- 319/-	80 368 190 200 280 280 182 210 24	428 428	930/- 233/-	160 120 400 315 550 16	140		2	5.5 225	A	16 100 80 8x19 8x19	125 - 159/237 203/227	80 - - 200 280 - 182 210 -	368 368	379/389 135/317	160 120 400 315 300 16	140		2	7.5 247	A	16 100 80 8x19 8x19	125 - 159/237 203/227	80 - - 200 280 - 182 210 -	368 368	429/389 135/317	160 120 400 315 300 16	140		80-315	2	11 270	C1	16 100 80 8x19 8x19	125 254 204/308 243/420	80 210 108 200 280 160 182 210 15	398 398	545/471 213/400	160 120 400 315 350 16		140	2	90 278	C1	16 100 80 8x19 8x19	125 457 433/- 319/-	80 368 190 250 315 280 216 243 24	428 428	930/- 233/-	160 120 400 315 550 16			140	2	110 295	C1	16 100 80 8x19 8x19	125 508 515/- 374/-	80 406 216 250 315 315 216 243 28	458 458	912/- 299/-	160 120 400 315 660 16		140	2	132 310	C1	16 100 80 8x19 8x19	125 508 515/- 374/-	80 457 216 250 315 315 216 243 28	458 458	1077/- 299/-	160 120 400 315 660 16		140		2	160 328	C1	16 100 80 8x19 8x19	125 508 515/- 374/-	80 457 216 250 315 315 216 243 28	458 458	1077/- 299/-	160 120 400 315 660 16		140	2	11 280	C1	16 100 80 8x19 8x19	125 254 204/308 243/420	80 210 108 250 315 160 216 243 15	398 398	545/471 213/400	160 120 400 315 350 16	140		80-400	2	15 305	C1	16 100 80 8x19 8x19	125 254 204/308 243/420	80 254 108 250 315 160 216 243 15	398 398	575/515 213/400	160 120 400 315 350 16		140	2	18.5 320	C1	16 100 80 8x19 8x19	125 279 286/308 189/420	80 241 121 250 315 180 216 243 15	398 398	588/541 164/400	160 120 400 315 350 16			140	2	22 334	C1	16 100 80 8x19 8x19	125 279 286/- 189/-	80 241 121 250 315 180 216 243 15	398 398	588/- 164/-	160 120 400 315 350 16		140	2	18.5 347	C1	16 100 80 8x19 8x19	125 279 286/308 189/420	80 241 121 280 355 180 266 287 15	396 398	588/541 164/400	160 120 435 355 350 16		140	2	22 365	C1	16 100 80 8x19 8x19	125 279 286/- 189/-	80 241 121 280 355 180 266 287 15	396 398	588/- 164/-	160 120 435 355 350 16		140	2		30 397	C1	16 100 80 8x19 8x19	125 318 315/- 265/-	80 305 133 280 355 200 266 287 19	396 398	636/- 197/-	160 120 435 355 400 16		140	2	37 419	C1	16 100 80 8x19 8x19	125 356 338/- 266/-	80 286 149 280 355 225 266 287 19	426 428	648/- 197/-	160 120 435 355 450 16		140	100-160	2	45 438	C1	16 100 80 8x19 8x19	125 356 338/- 266/-	80 286 149 280 355 225 266 287 19	426 428	708/- 197/-	160 120 435 355 450 16			140	2	18.5 160-154	C1	16 125 100 8x19 8x19	125 254 204/308 243/420	80 254 108 200 280 160 146 187 15	368 368	515/515 213/400	160 120 360 280 350 16		140	2	22 167	C1	16 125 100 8x19 8x19	125 279 204/308 243/420	80 241 121 200 280 180 146 187 15	368 368	541/541 213/400	160 120 360 280 350 16		140	2	30 176	C1	16 125 100 8x19 8x19		125 318 315/- 265/-	80 305 133 200 280 200 146 187 19	368 368	611/- 197/-	160 120 360 280 400 16		140	100-200	2	2.2 160-140	A	16 125 100 8x19 8x19	125 - 120/201 162/222	80 - - 200 280 - 146 187 -	318 318	335/334 103/280		160 120 360 280 250 16	140	2	3 169	A	16 125 100 8x19 8x19	125 - 120/201 162/222	80 - - 200 280 - 146 187 -	318 318	335/334 103/280		160 120 360 280 250 16	140	2	4 176	A	16 125 100 8x19 8x19	125 - 134/201 202/208	80 - - 200 280 - 146 187 -	318 318	372/334 103/280		160 120 360 280 250 16	140	2	0.55 160-140	A	16 125 100 8x19 8x19	125 - 120/- 75/-	80 - - 200 280 - 146 187 -	298 298	234/- 75/-		160 120 360 280 200 16		140	6	0.75 169	A	16 125 100 8x19 8x19	125 - 128/- 75/-	80 - - 200 280 - 146 187 -	298 298		281/- 75/-	160 120 360 280 200 16		140	2	1.1 176	A	16 125 100 8x19 8x19	125 - 128/- 75/-	80 - - 200 280 - 146 187 -	298 298	326/- 75/-	160 120 360 280 200 16		140	2	30 170	C1	16 125 100 8x19 8x19	125 318 315/- 265/-	80 305 133 200 280 200 169 212 19	398 398	611/- 197/-	160 120 360 280 400 16		140	2	37 181	C1	16 125 100 8x19 8x19	125 318 315/- 265/-	80 305 133 200 280 200 169 212 19	398 398	636/- 197/-	160 120 360 280 400 16			140	2	45 192	C1	16 125 100 8x19 8x19	125 356 338/- 266/-	80 286 149 200 280 225 169 212 19	428 428	708/- 197/-	160 120 360 280 450 16		140	2	55 203	C1	16 125 100 8x19 8x19	125 406 410/- 319/-	80 349 168 200 280 250 169 212 24	428 428	747/- 233/-	160 120 360 280 550 16		140	2	75 219	C1	16 125 100 8x19 8x19	125 457 433/- 319/-	80 368 190 200 280 280 169 212 24	428 428	820/- 233/-	160 120 360 280 550 16			140	4	4 178	A	16 125 100 8x19 8x19	125 - 134/201 202/208	80 - - 200 280 - 169 212 -	348 348	372/334 103/280	160 120 360 280 250 16	140		4	5.5 195	A	16 125 100 8x19 8x19	125 - 159/237 203/227	80 - - 200 280 - 169 212 -	368 368	379/389 135/317	160 120 360 280 300 16	140		6	7.5 211	A	16 125 100 8x19 8x19	125 - 159/237 203/227	80 - - 200 280 - 169 212 -	368 368	429/389 135/317	160 120 360 280 300 16	140		2	11 219	C1	16 125 100 8x19 8x19	125 254 204/308 243/420	80 210 108 200 280 160 169 212 15		398 398	545/471 213/400	160 120 360 280 350 16	140		2	1.1 182	A	16 125 100 8x19 8x19	125 - 128/- 75/-	80 - - 200 280 - 169 212 -	328 328	326/- 75/-	160 120 360 280 200 16	140		6	1.5 193	A	16 125 100 8x19 8x19	125 - 166/- 135/-	80 - - 200 280 - 169 212 -	348 348	336/- 112/-	160 120 360 280 250 16	140		6	2.2 214	A	16 125 100 8x19 8x19	125 - 177/- 135/-	80 - - 200 280 - 169 212 -	348 348	354/- 112/-	160 120 360 280 250 16	140		6	3 219	A	16 125 100 8x19 8x19	125 - 202/- 155/-	80 - - 200 280 - 169 212 -	368 368	385/- 130/-	160 120 360 280 300 16	140																																																																																																																																														
			80-315		2	11 270	C1	16 100 80 8x19 8x19	125 254 204/308 243/420	80 210 108 200 280 160 182 210 15	398 398	545/471 213/400	160 120 400 315 350 16	140		2	90 278	C1	16 100 80 8x19 8x19	125 457 433/- 319/-	80 368 190 250 315 280 216 243 24	428 428	930/- 233/-	160 120 400 315 550 16	140		2	110 295	C1	16 100 80 8x19 8x19	125 508 515/- 374/-	80 406 216 250 315 315 216 243 28	458 458	912/- 299/-	160 120 400 315 660 16	140		2	132 310	C1	16 100 80 8x19 8x19	125 508 515/- 374/-	80 457 216 250 315 315 216 243 28	458 458	1077/- 299/-	160 120 400 315 660 16	140		2	160 328	C1	16 100 80 8x19 8x19	125 508 515/- 374/-	80 457 216 250 315 315 216 243 28	458 458	1077/- 299/-	160 120 400 315 660 16	140		2	11 280	C1	16 100 80 8x19 8x19	125 254 204/308 243/420	80 210 108 250 315 160 216 243 15	398 398	545/471 213/400	160 120 400 315 350 16	140			80-400	2	15 305	C1	16 100 80 8x19 8x19	125 254 204/308 243/420	80 254 108 250 315 160 216 243 15	398 398	575/515 213/400	160 120 400 315 350 16		140	2	18.5 320	C1	16 100 80 8x19 8x19	125 279 286/308 189/420	80 241 121 250 315 180 216 243 15	398 398		588/541 164/400	160 120 400 315 350 16		140	2	22 334	C1	16 100 80 8x19 8x19	125 279 286/- 189/-	80 241 121 250 315 180 216 243 15	398 398	588/- 164/-	160 120 400 315 350 16		140	2	18.5 347	C1	16 100 80 8x19 8x19	125 279 286/308 189/420	80 241 121 280 355 180 266 287 15	396 398	588/541 164/400	160 120 435 355 350 16			140	2	22 365	C1	16 100 80 8x19 8x19	125 279 286/- 189/-	80 241 121 280 355 180 266 287 15	396 398	588/- 164/-	160 120 435 355 350 16		140	2	30 397	C1	16 100 80 8x19 8x19	125 318 315/- 265/-	80 305 133 280 355 200 266 287 19	396 398	636/- 197/-	160 120 435 355 400 16			140	2	37 419	C1	16 100 80 8x19 8x19	125 356 338/- 266/-	80 286 149 280 355 225 266 287 19	426 428	648/- 197/-	160 120 435 355 450 16		140	100-160	2	45 438	C1	16 100 80 8x19 8x19	125 356 338/- 266/-	80 286 149 280 355 225 266 287 19		426 428	708/- 197/-		160 120 435 355 450 16	140	2	18.5 160-154	C1	16 125 100 8x19 8x19	125 254 204/308 243/420	80 254 108 200 280 160 146 187 15	368 368	515/515 213/400		160 120 360 280 350 16	140	2	22 167	C1	16 125 100 8x19 8x19	125 279 204/308 243/420	80 241 121 200 280 180 146 187 15	368 368	541/541 213/400		160 120 360 280 350 16	140	2	30 176	C1	16 125 100 8x19 8x19	125 318 315/- 265/-	80 305 133 200 280 200 146 187 19	368 368	611/- 197/-			160 120 360 280 400 16	140	100-200	2	2.2 160-140	A	16 125 100 8x19 8x19	125 - 120/201 162/222	80 - - 200 280 - 146 187 -	318 318		335/334 103/280	160 120 360 280 250 16	140	2	3 169	A	16 125 100 8x19 8x19	125 - 120/201 162/222	80 - - 200 280 - 146 187 -	318 318			335/334 103/280	160 120 360 280 250 16	140	2	4 176	A	16 125 100 8x19 8x19	125 - 134/201 202/208		80 - - 200 280 - 146 187 -	318 318		372/334 103/280	160 120 360 280 250 16	140	2	0.55 160-140	A	16 125 100 8x19 8x19	125 - 120/- 75/-	80 - - 200 280 - 146 187 -	298 298		234/- 75/-	160 120 360 280 200 16	140	6	0.75 169	A	16 125 100 8x19 8x19	125 - 128/- 75/-	80 - - 200 280 - 146 187 -	298 298		281/- 75/-	160 120 360 280 200 16	140		2	1.1 176	A	16 125 100 8x19 8x19	125 - 128/- 75/-	80 - - 200 280 - 146 187 -	298 298			326/- 75/-	160 120 360 280 200 16	140	2	30 170	C1	16 125 100 8x19 8x19	125 318 315/- 265/-	80 305 133 200 280 200 169 212 19	398 398		611/- 197/-	160 120 360 280 400 16	140	2	37 181	C1	16 125 100 8x19 8x19	125 318 315/- 265/-	80 305 133 200 280 200 169 212 19	398 398		636/- 197/-	160 120 360 280 400 16	140	2	45 192	C1	16 125 100 8x19 8x19	125 356 338/- 266/-	80 286 149 200 280 225 169 212 19	428 428		708/- 197/-	160 120 360 280 450 16	140	2	55 203	C1	16 125 100 8x19 8x19		125 406 410/- 319/-	80 349 168 200 280 250 169 212 24	428 428		747/- 233/-	160 120 360 280 550 16	140	2	75 219	C1		16 125 100 8x19 8x19	125 457 433/- 319/-	80 368 190 200 280 280 169 212 24	428 428		820/- 233/-	160 120 360 280 550 16	140	4	4 178	A	16 125 100 8x19 8x19	125 - 134/201 202/208	80 - - 200 280 - 169 212 -	348 348		372/334 103/280	160 120 360 280 250 16	140	4	5.5 195	A	16 125 100 8x19 8x19	125 - 159/237 203/227	80 - - 200 280 - 169 212 -	368 368		379/389 135/317	160 120 360 280 300 16	140	6	7.5 211	A	16 125 100 8x19 8x19	125 - 159/237 203/227		80 - - 200 280 - 169 212 -	368 368		429/389 135/317	160 120 360 280 300 16	140	2	11 219	C1	16 125 100 8x19 8x19	125 254 204/308 243/420	80 210 108 200 280 160 169 212 15	398 398		545/471 213/400	160 120 360 280 350 16	140	2	1.1 182	A	16 125 100 8x19 8x19	125 - 128/- 75/-	80 - - 200 280 - 169 212 -	328 328		326/- 75/-	160 120 360 280 200 16	140	6	1.5 193	A	16 125 100 8x19 8x19	125 - 166/- 135/-	80 - - 200 280 - 169 212 -		348 348		336/- 112/-	160 120 360 280 250 16	140	6	2.2 214	A	16 125 100 8x19 8x19	125 - 177/- 135/-	80 - - 200 280 - 169 212 -	348 348		354/- 112/-	160 120 360 280 250 16	140	6	3 219	A	16 125 100 8x19 8x19	125 - 202/- 155/-	80 - - 200 280 - 169 212 -	368 368		385/- 130/-	160 120 360 280 300 16	140																																																																																																																																																																																																												
				80-400		2	15 305	C1	16 100 80 8x19 8x19	125 254 204/308 243/420	80 254 108 250 315 160 216 243 15	398 398	575/515 213/400	160 120 400 315 350 16	140		2	18.5 320	C1	16 100 80 8x19 8x19	125 279 286/308 189/420	80 241 121 250 315 180 216 243 15	398 398	588/541 164/400	160 120 400 315 350 16	140		2	22 334	C1	16 100 80 8x19 8x19	125 279 286/- 189/-	80 241 121 250 315 180 216 243 15	398 398	588/- 164/-	160 120 400 315 350 16	140		2	18.5 347	C1	16 100 80 8x19 8x19	125 279 286/308 189/420	80 241 121 280 355 180 266 287 15	396 398	588/541 164/400	160 120 435 355 350 16	140		2	22 365	C1	16 100 80 8x19 8x19	125 279 286/- 189/-	80 241 121 280 355 180 266 287 15	396 398	588/- 164/-	160 120 435 355 350 16	140		2	30 397	C1	16 100 80 8x19 8x19	125 318 315/- 265/-	80 305 133 280 355 200 266 287 19	396 398	636/- 197/-	160 120 435 355 400 16		140			2	37 419	C1	16 100 80 8x19 8x19	125 356 338/- 266/-	80 286 149 280 355 225 266 287 19	426 428	648/- 197/-	160 120 435 355 450 16	140		100-160	2	45 438	C1	16 100 80 8x19 8x19	125 356 338/- 266/-		80 286 149 280 355 225 266 287 19	426 428	708/- 197/-	160 120 435 355 450 16		140	2	18.5 160-154	C1	16 125 100 8x19 8x19	125 254 204/308 243/420	80 254 108 200 280 160 146 187 15	368 368	515/515 213/400	160 120 360 280 350 16		140	2	22 167	C1	16 125 100 8x19 8x19	125 279 204/308 243/420	80 241 121 200 280 180 146 187 15	368 368		541/541 213/400	160 120 360 280 350 16		140	2	30 176	C1	16 125 100 8x19 8x19	125 318 315/- 265/-	80 305 133 200 280 200 146 187 19	368 368	611/- 197/-	160 120 360 280 400 16		140	100-200	2	2.2 160-140	A	16 125 100 8x19 8x19	125 - 120/201 162/222	80 - - 200 280 - 146 187 -		318 318	335/334 103/280		160 120 360 280 250 16	140	2	3 169	A	16 125 100 8x19 8x19	125 - 120/201 162/222	80 - - 200 280 - 146 187 -	318 318	335/334 103/280			160 120 360 280 250 16	140	2	4 176	A		16 125 100 8x19 8x19	125 - 134/201 202/208	80 - - 200 280 - 146 187 -	318 318	372/334 103/280		160 120 360 280 250 16	140	2	0.55 160-140	A	16 125 100 8x19 8x19	125 - 120/- 75/-	80 - - 200 280 - 146 187 -	298 298	234/- 75/-		160 120 360 280 200 16	140	6	0.75 169	A	16 125 100 8x19 8x19	125 - 128/- 75/-	80 - - 200 280 - 146 187 -	298 298	281/- 75/-		160 120 360 280 200 16	140	2	1.1 176	A	16 125 100 8x19 8x19	125 - 128/- 75/-	80 - - 200 280 - 146 187 -		298 298	326/- 75/-			160 120 360 280 200 16	140	2	30 170	C1	16 125 100 8x19 8x19	125 318 315/- 265/-	80 305 133 200 280 200 169 212 19	398 398	611/- 197/-		160 120 360 280 400 16	140	2	37 181	C1	16 125 100 8x19 8x19		125 318 315/- 265/-	80 305 133 200 280 200 169 212 19	398 398	636/- 197/-		160 120 360 280 400 16	140	2	45 192		C1	16 125 100 8x19 8x19	125 356 338/- 266/-	80 286 149 200 280 225 169 212 19	428 428	708/- 197/-		160 120 360 280 450 16	140	2	55 203	C1	16 125 100 8x19 8x19	125 406 410/- 319/-	80 349 168 200 280 250 169 212 24	428 428	747/- 233/-		160 120 360 280 550 16	140	2	75 219	C1	16 125 100 8x19 8x19	125 457 433/- 319/-	80 368 190 200 280 280 169 212 24	428 428	820/- 233/-			160 120 360 280 550 16	140	4	4 178	A	16 125 100 8x19 8x19		125 - 134/201 202/208	80 - - 200 280 - 169 212 -	348 348	372/334 103/280		160 120 360 280 250 16	140	4	5.5 195	A	16 125 100 8x19 8x19	125 - 159/237 203/227	80 - - 200 280 - 169 212 -	368 368	379/389 135/317		160 120 360 280 300 16	140	6	7.5 211	A	16 125 100 8x19 8x19	125 - 159/237 203/227	80 - - 200 280 - 169 212 -	368 368	429/389 135/317		160 120 360 280 300 16	140	2	11 219	C1	16 125 100 8x19 8x19	125 254 204/308 243/420	80 210 108 200 280 160 169 212 15	398 398	545/471 213/400		160 120 360 280 350 16	140	2		1.1 182	A	16 125 100 8x19 8x19	125 - 128/- 75/-	80 - - 200 280 - 169 212 -	328 328	326/- 75/-		160 120 360 280 200 16	140		6	1.5 193	A	16 125 100 8x19 8x19	125 - 166/- 135/-	80 - - 200 280 - 169 212 -	348 348	336/- 112/-		160 120 360 280 250 16	140	6	2.2 214	A	16 125 100 8x19 8x19	125 - 177/- 135/-	80 - - 200 280 - 169 212 -	348 348	354/- 112/-		160 120 360 280 250 16	140	6	3 219	A	16 125 100 8x19 8x19	125 - 202/- 155/-	80 - - 200 280 - 169 212 -	368 368	385/- 130/-		160 120 360 280 300 16	140																																																																																																																																																																																																																																																																													
					100-160		2	45 438	C1	16 100 80 8x19 8x19	125 356 338/- 266/-	80 286 149 280 355 225 266 287 19	426 428	708/- 197/-	160 120 435 355 450 16	140		2	18.5 160-154	C1	16 125 100 8x19 8x19	125 254 204/308 243/420	80 254 108 200 280 160 146 187 15	368 368	515/515 213/400	160 120 360 280 350 16	140		2	22 167	C1	16 125 100 8x19 8x19	125 279 204/308 243/420	80 241 121 200 280 180 146 187 15	368 368	541/541 213/400	160 120 360 280 350 16	140		2	30 176	C1	16 125 100 8x19 8x19	125 318 315/- 265/-	80 305 133 200 280 200 146 187 19	368 368	611/- 197/-	160 120 360 280 400 16	140		100-200	2	2.2 160-140	A	16 125 100 8x19 8x19	125 - 120/201 162/222	80 - - 200 280 - 146 187 -	318 318	335/334 103/280	160 120 360 280 250 16		140	2	3 169	A	16 125 100 8x19 8x19	125 - 120/201 162/222	80 - - 200 280 - 146 187 -	318 318		335/334 103/280		160 120 360 280 250 16		140	2	4 176	A	16 125 100 8x19 8x19	125 - 134/201 202/208	80 - - 200 280 - 146 187 -	318 318	372/334 103/280	160 120 360 280 250 16			140	2	0.55 160-140	A		16 125 100 8x19 8x19	125 - 120/- 75/-	80 - - 200 280 - 146 187 -	298 298	234/- 75/-	160 120 360 280 200 16		140	6	0.75 169	A	16 125 100 8x19 8x19	125 - 128/- 75/-	80 - - 200 280 - 146 187 -	298 298	281/- 75/-	160 120 360 280 200 16		140	2	1.1 176	A	16 125 100 8x19 8x19	125 - 128/- 75/-		80 - - 200 280 - 146 187 -	298 298	326/- 75/-	160 120 360 280 200 16		140	2	30 170	C1	16 125 100 8x19 8x19	125 318 315/- 265/-	80 305 133 200 280 200 169 212 19	398 398	611/- 197/-	160 120 360 280 400 16			140	2	37 181	C1	16 125 100 8x19 8x19		125 318 315/- 265/-	80 305 133 200 280 200 169 212 19	398 398	636/- 197/-	160 120 360 280 400 16		140	2	45 192	C1	16 125 100 8x19 8x19	125 356 338/- 266/-	80 286 149 200 280 225 169 212 19		428 428	708/- 197/-	160 120 360 280 450 16		140	2		55 203	C1	16 125 100 8x19 8x19	125 406 410/- 319/-	80 349 168 200 280 250 169 212 24	428 428	747/- 233/-	160 120 360 280 550 16		140	2	75 219	C1	16 125 100 8x19 8x19	125 457 433/- 319/-	80 368 190 200 280 280 169 212 24	428 428	820/- 233/-	160 120 360 280 550 16		140	4	4 178	A	16 125 100 8x19 8x19	125 - 134/201 202/208	80 - - 200 280 - 169 212 -	348 348	372/334 103/280	160 120 360 280 250 16		140	4	5.5 195	A	16 125 100 8x19 8x19		125 - 159/237 203/227	80 - - 200 280 - 169 212 -		368 368	379/389 135/317	160 120 360 280 300 16		140	6	7.5 211	A	16 125 100 8x19 8x19	125 - 159/237 203/227	80 - - 200 280 - 169 212 -	368 368	429/389 135/317	160 120 360 280 300 16		140	2	11 219		C1	16 125 100 8x19 8x19	125 254 204/308 243/420	80 210 108 200 280 160 169 212 15	398 398	545/471 213/400	160 120 360 280 350 16		140		2	1.1 182	A	16 125 100 8x19 8x19	125 - 128/- 75/-	80 - - 200 280 - 169 212 -	328 328	326/- 75/-	160 120 360 280 200 16		140	6	1.5 193	A	16 125 100 8x19 8x19	125 - 166/- 135/-	80 - - 200 280 - 169 212 -	348 348	336/- 112/-	160 120 360 280 250 16		140	6	2.2 214	A	16 125 100 8x19 8x19	125 - 177/- 135/-	80 - - 200 280 - 169 212 -		348 348	354/- 112/-	160 120 360 280 250 16		140	6	3 219		A	16 125 100 8x19 8x19	125 - 202/- 155/-	80 - - 200 280 - 169 212 -	368 368	385/- 130/-	160 120 360 280 300 16		140																																																																																																																																																																																																																																																																																																																																																										
						100-200		2	2.2 160-140	A	16 125 100 8x19 8x19	125 - 120/201 162/222	80 - - 200 280 - 146 187 -	318 318	335/334 103/280	160 120 360 280 250 16	140		2	3 169	A	16 125 100 8x19 8x19	125 - 120/201 162/222	80 - - 200 280 - 146 187 -	318 318	335/334 103/280	160 120 360 280 250 16	140		2	4 176	A	16 125 100 8x19 8x19	125 - 134/201 202/208	80 - - 200 280 - 146 187 -	318 318	372/334 103/280	160 120 360 280 250 16	140		2	0.55 160-140	A	16 125 100 8x19 8x19	125 - 120/- 75/-	80 - - 200 280 - 146 187 -	298 298	234/- 75/-	160 120 360 280 200 16	140			6	0.75 169	A	16 125 100 8x19 8x19	125 - 128/- 75/-	80 - - 200 280 - 146 187 -	298 298	281/- 75/-	160 120 360 280 200 16	140		2	1.1 176	A	16 125 100 8x19 8x19	125 - 128/- 75/-	80 - - 200 280 - 146 187 -		298 298		326/- 75/-	160 120 360 280 200 16	140		2	30 170	C1	16 125 100 8x19 8x19	125 318 315/- 265/-	80 305 133 200 280 200 169 212 19	398 398	611/- 197/-		160 120 360 280 400 16	140		2	37 181		C1	16 125 100 8x19 8x19	125 318 315/- 265/-	80 305 133 200 280 200 169 212 19	398 398	636/- 197/-	160 120 360 280 400 16	140		2	45 192	C1	16 125 100 8x19 8x19	125 356 338/- 266/-	80 286 149 200 280 225 169 212 19	428 428	708/- 197/-	160 120 360 280 450 16	140		2	55 203	C1	16 125 100 8x19 8x19		125 406 410/- 319/-	80 349 168 200 280 250 169 212 24	428 428	747/- 233/-	160 120 360 280 550 16	140		2	75 219	C1	16 125 100 8x19 8x19	125 457 433/- 319/-	80 368 190 200 280 280 169 212 24	428 428	820/- 233/-		160 120 360 280 550 16	140		4	4 178	A		16 125 100 8x19 8x19	125 - 134/201 202/208	80 - - 200 280 - 169 212 -	348 348	372/334 103/280	160 120 360 280 250 16	140		4	5.5 195	A	16 125 100 8x19 8x19	125 - 159/237 203/227		80 - - 200 280 - 169 212 -	368 368	379/389 135/317	160 120 360 280 300 16	140			6	7.5 211	A	16 125 100 8x19 8x19	125 - 159/237 203/227	80 - - 200 280 - 169 212 -	368 368	429/389 135/317	160 120 360 280 300 16	140		2	11 219	C1	16 125 100 8x19 8x19	125 254 204/308 243/420	80 210 108 200 280 160 169 212 15	398 398	545/471 213/400	160 120 360 280 350 16	140		2	1.1 182	A	16 125 100 8x19 8x19	125 - 128/- 75/-	80 - - 200 280 - 169 212 -	328 328	326/- 75/-	160 120 360 280 200 16	140		6	1.5 193	A		16 125 100 8x19 8x19	125 - 166/- 135/-		80 - - 200 280 - 169 212 -	348 348	336/- 112/-	160 120 360 280 250 16	140		6	2.2 214	A	16 125 100 8x19 8x19	125 - 177/- 135/-	80 - - 200 280 - 169 212 -	348 348	354/- 112/-	160 120 360 280 250 16	140		6		3 219	A	16 125 100 8x19 8x19	125 - 202/- 155/-	80 - - 200 280 - 169 212 -	368 368	385/- 130/-	160 120 360 280 300 16	140																																																																																																																																																																																																																																																																																																																																																																																																									
							6		0.75 169	A	16 125 100 8x19 8x19	125 - 128/- 75/-	80 - - 200 280 - 146 187 -	298 298	281/- 75/-	160 120 360 280 200 16	140	2		1.1 176	A	16 125 100 8x19 8x19	125 - 128/- 75/-	80 - - 200 280 - 146 187 -	298 298	326/- 75/-	160 120 360 280 200 16	140	2		30 170	C1	16 125 100 8x19 8x19	125 318 315/- 265/-	80 305 133 200 280 200 169 212 19	398 398	611/- 197/-	160 120 360 280 400 16	140	2		37 181	C1	16 125 100 8x19 8x19	125 318 315/- 265/-	80 305 133 200 280 200 169 212 19	398 398	636/- 197/-	160 120 360 280 400 16	140		2		45 192	C1	16 125 100 8x19 8x19	125 356 338/- 266/-	80 286 149 200 280 225 169 212 19	428 428	708/- 197/-	160 120 360 280 450 16	140	2		55 203	C1	16 125 100 8x19 8x19	125 406 410/- 319/-	80 349 168 200 280 250 169 212 24		428 428		747/- 233/-	160 120 360 280 550 16	140	2		75 219	C1	16 125 100 8x19 8x19	125 457 433/- 319/-	80 368 190 200 280 280 169 212 24	428 428	820/- 233/-		160 120 360 280 550 16	140	4		4 178		A	16 125 100 8x19 8x19	125 - 134/201 202/208	80 - - 200 280 - 169 212 -	348 348	372/334 103/280	160 120 360 280 250 16	140	4		5.5 195	A	16 125 100 8x19 8x19	125 - 159/237 203/227	80 - - 200 280 - 169 212 -	368 368	379/389 135/317	160 120 360 280 300 16	140	6		7.5 211	A	16 125 100 8x19 8x19		125 - 159/237 203/227	80 - - 200 280 - 169 212 -	368 368	429/389 135/317	160 120 360 280 300 16	140	2		11 219	C1	16 125 100 8x19 8x19	125 254 204/308 243/420	80 210 108 200 280 160 169 212 15	398 398	545/471 213/400		160 120 360 280 350 16	140	2		1.1 182	A		16 125 100 8x19 8x19	125 - 128/- 75/-	80 - - 200 280 - 169 212 -	328 328	326/- 75/-	160 120 360 280 200 16	140	6		1.5 193	A	16 125 100 8x19 8x19	125 - 166/- 135/-		80 - - 200 280 - 169 212 -	348 348	336/- 112/-	160 120 360 280 250 16	140	6			2.2 214	A	16 125 100 8x19 8x19	125 - 177/- 135/-	80 - - 200 280 - 169 212 -	348 348	354/- 112/-	160 120 360 280 250 16	140	6		3 219	A	16 125 100 8x19 8x19	125 - 202/- 155/-	80 - - 200 280 - 169 212 -	368 368	385/- 130/-	160 120 360 280 300 16	140																																																																																																																																																																																																																																																																																																																																																																																																																																																								
								2	37 181	C1	16 125 100 8x19 8x19	125 318 315/- 265/-	80 305 133 200 280 200 169 212 19	398 398	636/- 197/-	160 120 360 280 400 16	140		2	45 192	C1	16 125 100 8x19 8x19	125 356 338/- 266/-	80 286 149 200 280 225 169 212 19	428 428	708/- 197/-	160 120 360 280 450 16	140		2	55 203	C1	16 125 100 8x19 8x19	125 406 410/- 319/-	80 349 168 200 280 250 169 212 24	428 428	747/- 233/-	160 120 360 280 550 16	140		2	75 219	C1	16 125 100 8x19 8x19	125 457 433/- 319/-	80 368 190 200 280 280 169 212 24	428 428	820/- 233/-	160 120 360 280 550 16	140			4	4 178	A	16 125 100 8x19 8x19	125 - 134/201 202/208	80 - - 200 280 - 169 212 -	348 348	372/334 103/280	160 120 360 280 250 16	140		4	5.5 195	A	16 125 100 8x19 8x19	125 - 159/237 203/227	80 - - 200 280 - 169 212 -		368 368		379/389 135/317	160 120 360 280 300 16	140		6	7.5 211	A	16 125 100 8x19 8x19	125 - 159/237 203/227	80 - - 200 280 - 169 212 -	368 368	429/389 135/317		160 120 360 280 300 16	140		2	11 219		C1	16 125 100 8x19 8x19	125 254 204/308 243/420	80 210 108 200 280 160 169 212 15	398 398	545/471 213/400	160 120 360 280 350 16	140		2	1.1 182	A	16 125 100 8x19 8x19	125 - 128/- 75/-	80 - - 200 280 - 169 212 -	328 328	326/- 75/-	160 120 360 280 200 16	140		6	1.5 193	A	16 125 100 8x19 8x19		125 - 166/- 135/-	80 - - 200 280 - 169 212 -	348 348	336/- 112/-	160 120 360 280 250 16	140		6	2.2 214	A	16 125 100 8x19 8x19	125 - 177/- 135/-	80 - - 200 280 - 169 212 -	348 348	354/- 112/-		160 120 360 280 250 16	140		6	3 219	A		16 125 100 8x19 8x19	125 - 202/- 155/-	80 - - 200 280 - 169 212 -	368 368	385/- 130/-	160 120 360 280 300 16	140																																																																																																																																																																																																																																																																																																																																																																																																																																																																																											
							2		55 203	C1	16 125 100 8x19 8x19	125 406 410/- 319/-	80 349 168 200 280 250 169 212 24	428 428	747/- 233/-	160 120 360 280 550 16	140	2		75 219	C1	16 125 100 8x19 8x19	125 457 433/- 319/-	80 368 190 200 280 280 169 212 24	428 428	820/- 233/-	160 120 360 280 550 16	140	4		4 178	A	16 125 100 8x19 8x19	125 - 134/201 202/208	80 - - 200 280 - 169 212 -	348 348	372/334 103/280	160 120 360 280 250 16	140	4		5.5 195	A	16 125 100 8x19 8x19	125 - 159/237 203/227	80 - - 200 280 - 169 212 -	368 368	379/389 135/317	160 120 360 280 300 16	140		6		7.5 211	A	16 125 100 8x19 8x19	125 - 159/237 203/227	80 - - 200 280 - 169 212 -	368 368	429/389 135/317	160 120 360 280 300 16	140	2		11 219	C1	16 125 100 8x19 8x19	125 254 204/308 243/420	80 210 108 200 280 160 169 212 15		398 398		545/471 213/400	160 120 360 280 350 16	140	2		1.1 182	A	16 125 100 8x19 8x19	125 - 128/- 75/-	80 - - 200 280 - 169 212 -	328 328	326/- 75/-		160 120 360 280 200 16	140	6		1.5 193		A	16 125 100 8x19 8x19	125 - 166/- 135/-	80 - - 200 280 - 169 212 -	348 348	336/- 112/-	160 120 360 280 250 16	140	6		2.2 214	A	16 125 100 8x19 8x19	125 - 177/- 135/-	80 - - 200 280 - 169 212 -	348 348	354/- 112/-	160 120 360 280 250 16	140	6		3 219	A	16 125 100 8x19 8x19		125 - 202/- 155/-	80 - - 200 280 - 169 212 -	368 368	385/- 130/-	160 120 360 280 300 16	140																																																																																																																																																																																																																																																																																																																																																																																																																																																																																																																			
4								4 178	A	16 125 100 8x19 8x19	125 - 134/201 202/208	80 - - 200 280 - 169 212 -	348 348	372/334 103/280	160 120 360 280 250 16	140	4		5.5 195	A	16 125 100 8x19 8x19	125 - 159/237 203/227	80 - - 200 280 - 169 212 -	368 368	379/389 135/317	160 120 360 280 300 16	140	6		7.5 211	A	16 125 100 8x19 8x19	125 - 159/237 203/227	80 - - 200 280 - 169 212 -	368 368	429/389 135/317	160 120 360 280 300 16	140	2		11 219	C1	16 125 100 8x19 8x19	125 254 204/308 243/420	80 210 108 200 280 160 169 212 15	398 398	545/471 213/400	160 120 360 280 350 16	140	2			1.1 182	A	16 125 100 8x19 8x19	125 - 128/- 75/-	80 - - 200 280 - 169 212 -	328 328	326/- 75/-	160 120 360 280 200 16	140	6		1.5 193	A	16 125 100 8x19 8x19	125 - 166/- 135/-	80 - - 200 280 - 169 212 -	348 348		336/- 112/-		160 120 360 280 250 16	140	6		2.2 214	A	16 125 100 8x19 8x19	125 - 177/- 135/-	80 - - 200 280 - 169 212 -	348 348	354/- 112/-	160 120 360 280 250 16		140	6		3 219	A		16 125 100 8x19 8x19	125 - 202/- 155/-	80 - - 200 280 - 169 212 -	368 368	385/- 130/-	160 120 360 280 300 16	140																																																																																																																																																																																																																																																																																																																																																																																																																																																																																																																																											
		6					7.5 211	A	16 125 100 8x19 8x19	125 - 159/237 203/227	80 - - 200 280 - 169 212 -	368 368	429/389 135/317	160 120 360 280 300 16	140	2		11 219	C1	16 125 100 8x19 8x19	125 254 204/308 243/420	80 210 108 200 280 160 169 212 15	398 398	545/471 213/400	160 120 360 280 350 16	140	2		1.1 182	A	16 125 100 8x19 8x19	125 - 128/- 75/-	80 - - 200 280 - 169 212 -	328 328	326/- 75/-	160 120 360 280 200 16	140	6		1.5 193	A	16 125 100 8x19 8x19	125 - 166/- 135/-	80 - - 200 280 - 169 212 -	348 348	336/- 112/-	160 120 360 280 250 16	140	6			2.2 214	A	16 125 100 8x19 8x19	125 - 177/- 135/-	80 - - 200 280 - 169 212 -	348 348	354/- 112/-	160 120 360 280 250 16	140	6		3 219	A	16 125 100 8x19 8x19	125 - 202/- 155/-	80 - - 200 280 - 169 212 -	368 368	385/- 130/-		160 120 360 280 300 16		140																																																																																																																																																																																																																																																																																																																																																																																																																																																																																																																																																																				
2	11 219						C1	16 125 100 8x19 8x19	125 254 204/308 243/420	80 210 108 200 280 160 169 212 15	398 398	545/471 213/400	160 120 360 280 350 16	140	2		1.1 182	A	16 125 100 8x19 8x19	125 - 128/- 75/-	80 - - 200 280 - 169 212 -	328 328	326/- 75/-	160 120 360 280 200 16	140	6		1.5 193	A	16 125 100 8x19 8x19	125 - 166/- 135/-	80 - - 200 280 - 169 212 -	348 348	336/- 112/-	160 120 360 280 250 16	140	6		2.2 214	A	16 125 100 8x19 8x19	125 - 177/- 135/-	80 - - 200 280 - 169 212 -	348 348	354/- 112/-	160 120 360 280 250 16	140	6		3 219		A	16 125 100 8x19 8x19	125 - 202/- 155/-	80 - - 200 280 - 169 212 -	368 368	385/- 130/-	160 120 360 280 300 16	140																																																																																																																																																																																																																																																																																																																																																																																																																																																																																																																																																																																		
	6	1.5 193	A				16 125 100 8x19 8x19	125 - 166/- 135/-	80 - - 200 280 - 169 212 -	348 348	336/- 112/-	160 120 360 280 250 16	140	6		2.2 214	A	16 125 100 8x19 8x19	125 - 177/- 135/-	80 - - 200 280 - 169 212 -	348 348	354/- 112/-	160 120 360 280 250 16	140	6		3 219	A	16 125 100 8x19 8x19	125 - 202/- 155/-	80 - - 200 280 - 169 212 -	368 368	385/- 130/-	160 120 360 280 300 16	140																																																																																																																																																																																																																																																																																																																																																																																																																																																																																																																																																																																																										
6		2.2 214	A	16 125 100 8x19 8x19			125 - 177/- 135/-	80 - - 200 280 - 169 212 -	348 348	354/- 112/-	160 120 360 280 250 16	140	6		3 219	A	16 125 100 8x19 8x19	125 - 202/- 155/-	80 - - 200 280 - 169 212 -	368 368	385/- 130/-	160 120 360 280 300 16	140																																																																																																																																																																																																																																																																																																																																																																																																																																																																																																																																																																																																																						
	6	3 219	A	16 125 100 8x19 8x19	125 - 202/- 155/-		80 - - 200 280 - 169 212 -	368 368	385/- 130/-	160 120 360 280 300 16	140																																																																																																																																																																																																																																																																																																																																																																																																																																																																																																																																																																																																																																		

¹ Pump with standard motor or pump with E-motor.

² X: Service dimension.

Pump size	Poles	Actual impeller size	Mounting design	Flanges					NB dimensions [mm]																							
				PN	DNS	DNd	Ss	Sd	a	A	AD ¹	AG ¹	b	B	C	h1	h2	H	G1	G2	K	L		LB ¹	LL ¹	m1	m2	n1	n2	P	s1	X ²
																						Cl	SS									
100-250	2	55 205	C1	16 125 100 8x19 8x19	140 406 410/- 319/-	80 349 168 225 280 250 200 232 24	443 443	747/- 233/-	160 120 400 315 550 16	140																						
		75 229	C1	16 125 100 8x19 8x19	140 457 433/- 319/-	80 368 190 225 280 280 200 232 24	443 443	820/- 233/-	160 120 400 315 550 16	140																						
		90 242	C1	16 125 100 8x19 8x19	140 457 433/- 319/-	80 368 190 225 280 280 200 232 24	443 443	930/- 233/-	160 120 400 315 550 16	140																						
		110 258	C1	16 125 100 8x19 8x19	140 508 515/- 374/-	80 406 216 225 280 315 200 232 28	473 473	912/- 299/-	160 120 400 315 660 16	140																						
		132 274	C1	16 125 100 8x19 8x19	140 508 515/- 374/-	80 457 216 225 280 315 200 232 28	473 473	1077/- 299/-	160 120 400 315 660 16	140																						
		7.5 215	A	16 125 100 8x19 8x19	140 - 159/237 203/227	80 - - 225 280 - 200 232 -	383 383	429/389 135/317	160 120 400 315 300 16	140																						
	4	11 245	C1	16 125 100 8x19 8x19	140 254 204/308 243/420	80 210 108 225 280 160 200 232 15	413 413	545/471 213/400	160 120 400 315 350 16	140																						
		15 274	C1	16 125 100 8x19 8x19	140 254 204/308 243/420	80 254 108 225 280 160 200 232 15	413 413	575/515 213/400	160 120 400 315 350 16	140																						
		2.2 216	A	16 125 100 8x19 8x19	140 - 177/- 135/-	80 - - 225 280 - 200 232 -	363 363	354/- 112/-	160 120 400 315 250 16	140																						
		3 236	A	16 125 100 8x19 8x19	140 - 202/- 155/-	80 - - 225 280 - 200 232 -	383 383	385/- 130/-	160 120 400 315 300 16	140																						
		4 260	A	16 125 100 8x19 8x19	140 - 202/- 155/-	80 - - 225 280 - 200 232 -	383 383	385/- 130/-	160 120 400 315 300 16	140																						
		5.5 274	A	16 125 100 8x19 8x19	140 - 202/- 155/-	80 - - 225 280 - 200 232 -	383 383	435/- 130/-	160 120 400 315 300 16	140																						
100-315	2	110 269	C1	16 125 100 8x19 8x19	140 508 515/- 374/-	80 406 216 250 315 315 208 264 28	473 473	912/- 299/-	160 120 400 315 660 16	140																						
		132 284	C1	16 125 100 8x19 8x19	140 508 515/- 374/-	80 457 216 250 315 315 208 264 28	473 473	1077/- 299/-	160 120 400 315 660 16	140																						
		160 301	C1	16 125 100 8x19 8x19	140 508 515/- 374/-	80 457 216 250 315 315 208 264 28	473 473	1077/- 299/-	160 120 400 315 660 16	140																						
		200 322	C1	16 125 100 8x19 8x19	140 508 515/- 374/-	80 457 216 250 315 315 208 264 28	473 473	1232/- 299/-	160 120 400 315 660 16	140																						
		15 279	C1	16 125 100 8x19 8x19	140 254 204/308 243/420	80 254 108 225 280 315 160 208 264 15	413 413	575/515 213/400	160 120 400 315 350 16	140																						
		18.5 295	C1	16 125 100 8x19 8x19	140 279 286/308 189/420	80 241 121 250 315 180 208 264 15	413 413	558/541 164/400	160 120 400 315 350 16	140																						
	4	22 312	C1	16 125 100 8x19 8x19	140 279 286/- 189/-	80 241 121 250 315 180 208 264 15	413 413	588/- 164/-	160 120 400 315 350 16	140																						
		30 334	C1	16 125 100 8x19 8x19	140 318 315/- 265/-	80 305 133 250 315 200 208 264 19	413 413	636/- 197/-	160 120 400 315 400 16	140																						
		4 272	A	16 125 100 8x19 8x19	140 - 202/- 155/-	80 - - 250 315 - 208 264 -	383 383	385/- 130/-	160 120 400 315 300 16	140																						
		5.5 301	A	16 125 100 8x19 8x19	140 - 202/- 155/-	80 - - 250 315 - 208 264 -	383 383	435/- 130/-	160 120 400 315 300 16	140																						
		7.5 326	C1	16 125 100 8x19 8x19	140 254 237/- 175/-	80 210 108 250 315 160 208 264 15	413 413	494/- 145/-	160 120 400 315 350 16	140																						
		11 334	C1	16 125 100 8x19 8x19	140 254 237/- 175/-	80 254 108 250 315 160 208 264 15	413 413	554/- 145/-	160 120 400 315 350 16	140																						
100-400	2	22 334	C1	16 125 100 8x19 8x19	140 279 286/- 189/-	100 241 121 280 355 180 270 296 15	411 411	588/- 164/-	200 150 500 400 350 20	140																						
		30 360	C1	16 125 100 8x19 8x19	140 318 315/- 265/-	100 305 133 280 355 200 270 296 19	411 411	636/- 197/-	200 150 500 400 400 20	140																						
		37 375	C1	16 125 100 8x19 8x19	140 356 338/- 266/-	100 286 149 280 355 225 270 296 19	441 441	648/- 197/-	200 150 500 400 450 20	140																						
		45 395	C1	16 125 100 8x19 8x19	140 356 338/- 266/-	100 286 149 280 355 225 270 296 19	441 441	708/- 197/-	200 150 500 400 450 20	140																						
		55 415	C1	16 125 100 8x19 8x19	140 406 410/- 319/-	100 349 168 280 355 160 270 296 24	441 441	747/- 233/-	200 150 500 400 550 20	140																						
		7.5 340	C1	16 125 100 8x19 8x19	140 254 237/- 175/-	100 210 108 280 355 160 270 296 15	411 411	494/- 145/-	200 150 500 400 350 20	140																						
	4	11 380	C1	16 125 100 8x19 8x19	140 254 237/- 175/-	100 254 108 280 355 160 270 296 15	411 411	554/- 145/-	200 150 500 400 350 20	140																						
		15 415	C1	16 125 100 8x19 8x19	140 279 286/- 189/-	100 241 121 280 355 180 270 296 15	411 411	588/- 164/-	200 150 500 400 350 20	140																						
		45 176-154	C1	16 150 125 8x23 8x19	140 356 338/- 266/-	80 286 149 250 315 225 200 252 19	443 443	708/- 197/-	160 120 400 315 450 16	140																						
		55 196-166	C1	16 150 125 8x23 8x19	140 406 410/- 319/-	80 349 168 250 315 250 200 252 24	443 443	747/- 233/-	160 120 400 315 550 16	140																						
		75 205	C1	16 150 125 8x23 8x19	140 457 433/- 319/-	80 368 190 250 315 280 200 252 24	443 443	820/- 233/-	160 120 400 315 550 16	140																						
		90 219	C1	16 150 125 8x23 8x19	140 457 433/- 319/-	80 368 190 250 315 280 200 252 24	443 443	930/- 233/-	160 120 400 315 550 16	140																						
125-200	2	110 224	C1	16 150 125 8x23 8x19	140 508 515/- 374/-	80 406 216 250 315 315 200 252 28	473 473	912/- 299/-	160 120 400 315 660 16	140																						
		5.5 176-154	A	16 150 125 8x23 8x19	140 - 159/237 203/227	80 - - 250 315 - 200 252 -	383 383	379/389 135/317	160 120 400 315 300 16	140																						
		7.5 196-180	A	16 150 125 8x23 8x19	140 - 159/237 203/227	80 - - 250 315 - 200 252 -	383 383	429/389 135/317	160 120 400 315 300 16	140																						
		11 219	C1	16 150 125 8x23 8x19	140 254 204/308 243/420	80 210 108 250 315 160 200 252 15	413 413	545/471 213/400	160 120 400 315 350 16	140																						
		15 226	C1	16 150 125 8x23 8x19	140 254 204/308 243/420	80 254 108 250 315 160 200 252 15	413 413	575/515 213/400	160 120 400 315 350 16	140																						
		1.5 176-150	A	16 150 125 8x23 8x19	140 - 166/- 135/-	80 - - 250 315 - 200 252 -	363 363	336/- 112/-	160 120 400 315 250 16	140																						
	4	2.2 196-182	A	16 150 125 8x23 8x19	140 - 177/- 135/-	80 - - 250 315 - 200 252 -	363 363	354/- 112/-	160 120 400 315 250 16	140																						
		3 215	A	16 150 125 8x23 8x19	140 - 202/- 155/-	80 - - 250 315 - 200 252 -	383 383	385/- 130/-	160 120 400 315 300 16	140																						
		4 226	A	16 150 125 8x23 8x19	140 - 202/- 155/-	80 - - 250 315 - 200 252 -	383 383	385/- 130/-	160 120 400 315 300 16	140																						
		90 222	C1	16 150 125 8x23 8x19	140 457 433/- 319/-	80 368 190 250 355 280 208 264 24	441 441	930/- 233/-	160 120 400 315 550 16	140																						
		110 236	C1	16 150 125 8x23 8x19	140 508 515/- 374/-	80 406 216 250 355 315 208 264 28	471 471	912/- 299/-	160 120 400 315 660 16	140																						
		132 249	C1	16 150 125 8x23 8x19	140 508 515/- 374/-	80 457 216 250 355 315 208 264 28	471 471	1077/- 299/-	160 120 400 315 660 16	140																						
125-250	2	160 263	C1	16 150 125 8x23 8x19	140 508 515/- 374/-	80 457 216 250 355 315 208 264 28	471 471	1077/- 299/-	160 120 400 315 660 16	140																						
		200 269	C1	16 150 125 8x23 8x19	140 508 515/- 374/-	80 457 216 250 355 315 208 264 28	471 471	1232/- 299/-	160 120 400 315 660 16	140																						
		11 220	C1	16 150 125 8x23 8x19	140 254 204/308 243/420	80 210 108 250 355 160 208 264 15	413 413	545/471 213/400	160 120 400 315 350 16	140																						
		15 236	C1	16 150 125 8x23 8x19	140 254 204/308 243/420	80 254 108 250 355 160 208 264 15	413 413	575/515 213/400	160 120 400 315 350 16	140																						
		18.5 249	C1	16 150 125 8x23 8x19	140 279 286/308 189/420	80 241 121 250 355 180 208 264 15	413 413	558/541 164/400	160 120 400 315 350 16	140																						
		22 262	C1	16 150 125 8x23 8x19	140 279 286/- 189/-	80 241 121 250 355 180 208 264 15	413 413	588/- 164/-	160 120 400 315 350 16	140																						
	4	30 269	C1	16 150 125 8x23 8x19	140 318 315/- 265/-	80 305 133 250 355 200 208 264 19	413 413	636/- 197/-	160 120 400 315 400 16	140																						
		3 216	A	16 150 125 8x23 8x19	140 - 202/- 155/-	80 - - 250 355 - 208 264 -	383 383	385/- 130/-	160 120 400 315 300 16	140																						
		4 232	A	16 150 125 8x23 8x19	140 - 202/- 155/-	80 - - 250 355 - 208 264 -	383 383	385/- 130/-	160 120 400 315 300 16	140																						
		5.5 253	A	16 150 125 8x23 8x19	140 - 202/- 155/-	80 - - 250 355 - 208 264 -	383 383	435/- 130/-	160 120 400 315 300 16	140																						
		7.5 269	C1	16 150 125 8x23 8x19	140 254 237/- 175/-	80 210 108 250 355 160 208 264 15	413 413	494/- 145/-	160 120 400 315 350 16	140																						

¹ Pump with standard motor or pump with E-motor.
² X: Service dimension.

Pump size	Poles	P2 [kW]	Actual impeller size	Mounting design	Flanges		NB dimensions [mm]																										
					PN	DNS	DNd	Ss	Sd	a	A	AD ¹	AG ¹	b	B	C	h1	h2	H	G1	G2	K	L		LB ¹	LL ¹	m1	m2	n1	n2	P	s1	X ²
																							Cl	Ss									
125-315	2	132	262	C1	16	150	125	8x23	8x19	140	508	515/-	374/-	100	457	216	280	355	315	231	268	28	471	471	1077/-	299/-	200	150	500	400	660	20	140
		160	277	C1	16	150	125	8x23	8x19	140	508	515/-	374/-	100	457	216	280	355	315	231	268	28	471	471	1077/-	299/-	200	150	500	400	660	20	140
		200	297	C1	16	150	125	8x23	8x19	140	508	515/-	374/-	100	457	216	280	355	315	231	268	28	471	471	1232/-	299/-	200	150	500	400	660	20	140
	4	18.5	275	C1	16	150	125	8x23	8x19	140	279	286/308	189/420	100	241	121	280	355	180	231	268	15	411	411	558/541	164/400	200	150	500	400	350	20	140
		22	290	C1	16	150	125	8x23	8x19	140	279	286/-	189/-	100	241	121	280	355	180	231	268	15	411	411	588/-	164/-	200	150	500	400	350	20	140
		30	317	C1	16	150	125	8x23	8x19	140	318	315/-	265/-	100	305	133	280	355	200	231	268	19	411	411	636/-	197/-	200	150	500	400	400	20	140
	6	37	336	C1	16	150	125	8x23	8x19	140	356	338/-	266/-	100	286	149	280	355	225	231	268	19	441	441	648/-	197/-	200	150	500	400	450	20	140
		45	338	C1	16	150	125	8x23	8x19	140	356	338/-	266/-	100	286	149	280	355	225	231	268	19	441	441	708/-	197/-	200	150	500	400	450	20	140
		5.5	275	A	16	150	125	8x23	8x19	140	-	202/-	155/-	100	-	-	280	355	-	231	268	-	381	381	435/-	130/-	200	150	500	400	300	20	140
		7.5	297	C1	16	150	125	8x23	8x19	140	254	237/-	175/-	100	210	108	280	355	160	231	268	15	411	411	494/-	145/-	200	150	500	400	350	20	140
		11	335	C1	16	150	125	8x23	8x19	140	254	237/-	175/-	100	254	108	280	355	160	231	268	15	411	411	554/-	145/-	200	150	500	400	350	20	140
		15	338	C1	16	150	125	8x23	8x19	140	279	286/-	189/-	100	241	121	280	355	180	231	268	15	411	411	588/-	164/-	200	150	500	400	350	20	140
125-400	4	37	345	C1	16	150	125	8x23	8x19	140	356	338/-	266/-	100	286	149	315	400	225	284	320	19	441	441	648/-	197/-	200	150	500	400	400	20	140
		45	368	C1	16	150	125	8x23	8x19	140	356	338/-	266/-	100	286	149	315	400	225	284	320	19	441	441	708/-	197/-	200	150	500	400	450	20	140
		55	392	C1	16	150	125	8x23	8x19	140	406	410/-	319/-	100	349	168	315	400	250	284	320	24	441	441	747/-	233/-	200	150	500	400	550	20	140
	6	75	433	C1	16	150	125	8x23	8x19	140	457	433/-	319/-	100	368	190	315	400	280	284	320	24	441	441	820/-	233/-	200	150	500	400	550	20	140
		90	438	C1	16	150	125	8x23	8x19	140	457	433/-	319/-	100	368	190	315	400	280	284	320	24	441	441	930/-	233/-	200	150	500	400	550	20	140
		11	351	C1	16	150	125	8x23	8x19	140	254	237/-	175/-	100	254	108	315	400	160	284	320	15	411	411	554/-	145/-	200	150	500	400	350	20	140
	8	15	384	C1	16	150	125	8x23	8x19	140	279	286/-	189/-	100	241	121	315	400	180	284	320	15	411	411	588/-	164/-	200	150	500	400	350	20	140
		18.5	410	C1	16	150	125	8x23	8x19	140	318	315/-	265/-	100	305	133	315	400	200	284	320	19	411	411	611/-	197/-	200	150	500	400	400	20	140
		22	434	C1	16	150	125	8x23	8x19	140	318	315/-	265/-	100	305	133	315	400	200	284	320	19	411	411	636/-	197/-	200	150	500	400	400	20	140
		30	438	C1	16	150	125	8x23	8x19	140	356	338/-	266/-	100	286	149	315	400	225	284	320	19	441	441	708/-	197/-	200	150	500	400	450	20	140
		55	406	C1	16	150	125	8x23	8x19	180	406	410/-	319/-	125	349	168	400	500	250	344	377	24	524	524	747/-	233/-	200	150	625	500	550	20	180
		75	447	C1	16	150	125	8x23	8x19	180	457	433/-	319/-	125	368	190	400	500	280	344	377	24	524	524	820/-	233/-	200	150	625	500	550	20	180
10	90	473	C1	16	150	125	8x23	8x19	180	457	433/-	319/-	125	368	190	400	500	280	344	377	24	524	524	930/-	233/-	200	150	625	500	550	20	180	
	110	500	C1	16	150	125	8x23	8x19	180	508	515/-	374/-	125	406	216	400	500	315	344	377	28	554	554	912/-	299/-	200	150	625	500	660	20	180	
	132	526	C1	16	150	125	8x23	8x19	180	508	515/-	374/-	125	457	216	400	500	315	344	377	28	554	554	1077/-	299/-	200	150	625	500	660	20	180	
	160	548	C1	16	150	125	8x23	8x19	180	508	515/-	374/-	125	457	216	400	500	315	344	377	28	554	554	1077/-	299/-	200	150	625	500	660	20	180	
	18.5	421	C1	16	150	125	8x23	8x19	180	318	315/-	265/-	125	305	133	400	500	200	344	377	19	494	494	611/-	197/-	200	150	625	500	400	20	180	
	22	445	C1	16	150	125	8x23	8x19	180	318	315/-	265/-	125	305	133	400	500	200	344	377	19	494	494	636/-	197/-	200	150	625	500	400	20	180	
12	30	493	C1	16	150	125	8x23	8x19	180	356	338/-	266/-	125	286	149	400	500	225	344	377	19	524	524	708/-	197/-	200	150	625	500	450	20	180	
	37	524	C1	16	150	125	8x23	8x19	180	406	410/-	319/-	125	349	168	400	500	250	344	377	24	524	524	747/-	233/-	200	150	625	500	550	20	180	
	45	546	C1	16	150	125	8x23	8x19	180	457	433/-	319/-	125	368	190	400	500	280	344	377	24	524	524	820/-	233/-	200	150	625	500	550	20	180	
	55	548	C1	16	150	125	8x23	8x19	180	457	433/-	319/-	125	368	190	400	500	280	344	377	24	524	524	820/-	233/-	200	150	625	500	550	20	180	
	75	216-176	C1	10	200	150	8x23	8x23	160	457	433/-	319/-	100	368	190	280	400	280	230	319	24	463	463	820/-	233/-	200	150	550	450	550	20	140	
	90	218-202	C1	10	200	150	8x23	8x23	160	457	433/-	319/-	100	368	190	280	400	280	230	319	24	463	463	930/-	233/-	200	150	550	450	550	20	140	
150-200	2	110	224	C1	10	200	150	8x23	8x23	160	508	515/-	374/-	100	406	216	280	400	315	230	319	28	493	493	912/-	299/-	200	150	550	450	660	20	140
		7.5	210-158	A	10	200	150	8x23	8x23	160	-	159/237	203/227	100	-	-	280	400	-	230	319	-	403	403	429/389	135/317	200	150	550	450	300	20	140
		11	218-208	C1	10	200	150	8x23	8x23	160	254	204/308	243/420	100	210	108	280	400	160	230	319	15	433	433	545/471	213/400	200	150	550	450	350	20	140
	4	15	224	C																													

Pump size	Poles	P2 [kW]	Actual impeller size	Mounting design	Flanges		NB dimensions [mm]																										
					PN	DNS	DNd	Ss	Sd	a	A	AD ¹	AG ¹	b	B	C	h1	h2	H	G1	G2	K	L		LB ¹	LL ¹	m1	m2	n1	n2	P	s1	X ²
																							CI	SS									
150-315.2	2	160 244	C1	10 200 150 8x23 8x23	160 508	515/-	374/-	100 457	216 280 400 315 264 334 28	491 491	1077/-	299/-	200 150 550 450 660 20	140																			
		200 262	C1	10 200 150 8x23 8x23	160 508	515/-	374/-	100 457	216 280 400 315 264 334 28	491 491	1232/-	299/-	200 150 550 450 660 20	140																			
		22 250	C1	10 200 150 8x23 8x23	160 279	286/-	189/-	100 241	121 280 400 180 264 334 15	431 431	588/-	164/-	200 150 550 450 350 20	140																			
	4	30 275	C1	10 200 150 8x23 8x23	160 318	315/-	265/-	100 305	133 280 400 200 264 334 19	431 431	636/-	197/-	200 150 550 450 400 20	140																			
		37 294	C1	10 200 150 8x23 8x23	160 356	338/-	266/-	100 286	149 280 400 225 264 334 19	461 461	648/-	197/-	200 150 550 450 450 20	140																			
		45 314	C1	10 200 150 8x23 8x23	160 356	338/-	266/-	100 286	149 280 400 225 264 334 19	461 461	708/-	197/-	200 150 550 450 450 20	140																			
	6	55 334	C1	10 200 150 8x23 8x23	160 406	410/-	319/-	100 349	168 280 400 250 264 334 24	461 461	747/-	233/-	200 150 550 450 550 20	140																			
		75 342	C1	10 200 150 8x23 8x23	160 457	433/-	319/-	100 368	190 280 400 280 264 334 24	461 461	820/-	233/-	200 150 550 450 550 20	140																			
		7.5 259	C1	10 200 150 8x23 8x23	160 254	237/-	175/-	100 210	108 280 400 160 264 334 15	431 431	494/-	145/-	200 150 550 450 350 20	140																			
		11 293	C1	10 200 150 8x23 8x23	160 254	237/-	175/-	100 254	108 280 400 160 264 334 15	431 431	554/-	145/-	200 150 550 450 350 20	140																			
		15 328	C1	10 200 150 8x23 8x23	160 279	286/-	189/-	100 241	121 280 400 180 264 334 15	431 431	588/-	164/-	200 150 550 450 350 20	140																			
		18.5 342	C1	10 200 150 8x23 8x23	160 318	315/-	265/-	100 305	133 280 400 200 264 334 19	431 431	611/-	197/-	200 150 550 450 400 20	140																			
150-315	4	37 275	C1	10 200 150 8x23 8x23	160 356	338/-	266/-	100 305	133 280 400 200 264 334 19	461 461	611/-	197/-	200 150 550 450 400 20	140																			
		45 291	C1	10 200 150 8x23 8x23	160 356	338/-	266/-	100 286	149 280 400 225 264 334 19	461 461	708/-	197/-	200 150 550 450 450 20	140																			
		55 310	C1	10 200 150 8x23 8x23	160 406	410/-	319/-	100 349	168 280 400 250 264 334 24	461 461	747/-	233/-	200 150 550 450 550 20	140																			
	6	75 336	C1	10 200 150 8x23 8x23	160 457	433/-	319/-	100 368	190 280 400 280 264 334 24	461 461	820/-	233/-	200 150 550 450 550 20	140																			
		90 338	C1	10 200 150 8x23 8x23	160 457	433/-	319/-	100 368	190 280 400 280 264 334 24	461 461	930/-	233/-	200 150 550 450 550 20	140																			
		11 280	C1	10 200 150 8x23 8x23	160 254	237/-	175/-	100 254	108 280 400 160 264 334 15	431 431	554/-	145/-	200 150 550 450 350 20	140																			
	4	15 305	C1	10 200 150 8x23 8x23	160 279	286/-	189/-	100 241	121 280 400 180 264 334 15	431 431	588/-	164/-	200 150 550 450 350 20	140																			
		18.5 322	C1	10 200 150 8x23 8x23	160 318	315/-	265/-	100 305	133 280 400 200 264 334 19	431 431	611/-	197/-	200 150 550 450 400 20	140																			
		22 337	C1	10 200 150 8x23 8x23	160 318	315/-	265/-	100 305	133 280 400 200 264 334 19	431 431	636/-	197/-	200 150 550 450 400 20	140																			
		30 338	C1	10 200 150 8x23 8x23	160 356	338/-	266/-	100 286	149 280 400 225 264 334 19	461 461	708/-	197/-	200 150 550 450 450 20	140																			
		55 343	C1	10 200 150 8x23 8x23	160 406	410/-	319/-	100 349	168 315 450 250 291 339 24	474 474	747/-	233/-	200 150 550 450 550 20	140																			
		75 375	C1	10 200 150 8x23 8x23	160 457	433/-	319/-	100 368	190 315 450 280 291 339 24	474 474	820/-	233/-	200 150 550 450 550 20	140																			
150-400	4	90 394	C1	10 200 150 8x23 8x23	160 457	433/-	319/-	100 368	190 315 450 280 291 339 24	474 474	930/-	233/-	200 150 550 450 550 20	140																			
		110 412	C1	10 200 150 8x23 8x23	160 508	515/-	374/-	100 406	216 315 450 315 291 339 28	504 504	912/-	299/-	200 150 550 450 660 20	140																			
		132 431	C1	10 200 150 8x23 8x23	160 508	515/-	374/-	100 457	216 315 450 315 291 339 28	504 504	1077/-	299/-	200 150 550 450 660 20	180																			
	6	160 438	C1	10 200 150 8x23 8x23	160 508	515/-	374/-	100 457	216 315 450 315 291 339 28	504 504	1077/-	299/-	200 150 550 450 660 20	180																			
		18.5 357	C1	10 200 150 8x23 8x23	160 318	315/-	265/-	100 305	133 315 450 200 291 339 19	444 444	611/-	197/-	200 150 550 450 400 20	140																			
		22 375	C1	10 200 150 8x23 8x23	160 318	315/-	265/-	100 305	133 315 450 200 291 339 19	444 444	636/-	197/-	200 150 550 450 400 20	140																			
	4	30 408	C1	10 200 150 8x23 8x23	160 356	338/-	266/-	100 286	149 315 450 225 291 339 19	474 474	708/-	197/-	200 150 550 450 450 20	140																			
		37 430	C1	10 200 150 8x23 8x23	160 406	410/-	319/-	100 349	168 315 450 250 291 339 24	474 474	747/-	233/-	200 150 550 450 550 20	140																			
		45 438	C1	10 200 150 8x23 8x23	160 457	433/-	319/-	100 368	190 315 450 280 291 339 24	474 474	820/-	233/-	200 150 550 450 550 20	140																			
		132 459	C1	10 200 150 8x23 8x23	180 508	515/-	374/-	125 457	216 400 500 315 353 396 28	554 554	1077/-	299/-	200 150 625 500 660 20	180																			
		160 489	C1	10 200 150 8x23 8x23	180 508	515/-	374/-	125 457	216 400 500 315 353 396 28	554 554	1077/-	299/-	200 150 625 500 660 20	180																			
		200 521	C1	10 200 150 8x23 8x23	180 508	515/-	374/-	125 457	216 400 500 315 353 396 28	554 554	1232/-	299/-	200 150 625 500 660 20	180																			
150-500	4	37 457	C1	10 200 150 8x23 8x23	180 406	410/-	319/-	125 349	168 400 500 250 353 396 24	524 524	747/-	233/-	200 150 625 500 550 20	180																			
		45 483	C1	10 200 150 8x23 8x23	180 457	433/-	319/-	125 368	190 400 500 280 353 396 24	524 524	820/-	233/-	200 150 625 500 550 20	180																			
		55 513	C1	10 200 150 8x23 8x23	180 457	433/-	319/-	125 368	190 400 500 280 353 396 24	524 524	820/-	233/-	200 150 625 500 550 20	180																			
	6	75 548	C1	10 200 150 8x23 8x23	180 508	515/-	374/-	125 406	216 400 500 315 353 396 28	554 554	912/-	299/-	200 150 625 500 660 20	180																			
		37 280	C2	10 250 200 12x23 8x23	170 356	338/-	266/-	125 286	149 400 400 225 331 485 19	512 -	648/-	197/-	200 150 625 500 450 20	180																			
		45 296	C2	10 250 200 12x23 8x23	170 356	338/-	266/-	125 286	149 400 400 225 331 485 19	512 -	708/-	197/-	200 150 625 500 450 20	180																			
	4	55 312	C2	10 250 200 12x23 8x23	170 406	410/-	319/-	125 349	168 400 400 250 331 485 24	512 -	747/-	233/-	200 150 625 500 550 20	180																			
		75 344	C2	10 250 200 12x23 8x23	170 457	433/-	319/-	125 368	190 400 400 280 331 485 24	512 -	820/-	233/-	200 150 625 500 550 20	180																			
		90 364	C2	10 250 200 12x23 8x23	170 457	433/-	319/-	125 368	190 400 400 280 331 485 24	512 -	930/-	233/-	200 150 625 500 550 20	180																			
		110 392	C2	10 250 200 12x23 8x23	170 508	515/-	374/-	125 406	216 400 400 315 331 485 28	542 -	912/-	299/-	200 150 625 500 660 20	180																			
		132 404	C2	10 250 200 12x23 8x23	170 508	515/-	374/-	125 457	216 400 400 315 331 485 28	542 -	1077/-	299/-	200 150 625 500 660 20	180																			
		15 308	C2	10 250 200 12x23 8x23	170 279	286/-	189/-	125 241	121 400 400 180 331 485 15	482 -	588/-	164/-	200 150 625 500 350 20	180																			
200-400	6	18.5 328	C2	10 250 200 12x23 8x23	170 318	315/-	265/-	125 305	133 400 400 200 331 485 19	482 -	611/-	197/-	200 150 625 500 400 20	180																			
		22 348	C2	10 250 200 12x23 8x23	170 318	315/-	265/-	125 305	133 400 400 200 331 485 19	482 -	636/-	197/-	200 150 625 500 400 20	180																			
		30 384	C2	10 250 200 12x23 8x23	170 356	338/-	266/-	125 286	149 400 400 225 331 485 19	512 -	708/-	197/-	200 150 625 500 450 20	180																			
	4	37 404	C2	10 250 200 12x23 8x23	170 406	410/-	319/-	125 349	168 400 400 250 331 485 24	512 -	747/-	233/-	200 150 625 500 550 20	180																			
		75 367	C2	10 250 200 12x23 8x23	150 457	433/-	319/-	125 368	190 400 450 280 355 525 24	487 -	820/-	233/-	200 150 625 500 550 20	180																			
		90 391	C2	10 250 200 12x23 8x23	150 457	433/-	319/-	125 368	190 400 450 280 355 525 24	487 -	930/-	233/-	200 150 625 500 550 20	180																			
	200-450	4	110 415	C2	10 250 200 12x23 8x23	150 508	515/-	374/-	125 406	216 400 450 315 355 525 28	517 -	912/-	299/-	200 150 625 500 660 20	180																		
			132 435	C2	10 250 200 12x23 8x23	150 508	515/-	374/-	125 457	216 400 450 315 355 525 28	517 -	1077/-	299/-	200 150 625 500 660 20	180																		
			160 455	C2	10 250 200 12x23 8x23	150 508	515/-	374/-	125 457	216 400 450 315 355 525 28	517 -	1077/-	299/-	200 150 625 500 660 20	180																		
		6	18.5 355	C2	10 250 200 12x23 8x23	150 31																											

Pump size	Poles	Actual impeller size	Mounting design	Flanges		NB dimensions [mm]																										
				PN	DNS	DND	Ss	Sd	a	A	AD ¹	AG ¹	b	B	C	h1	h2	H	G1	G2	K	L		LB ¹	LL ¹	m1	m2	n1	n2	P	s1	X ²
																						Cl	SS									
250-350	4	37 266	C2	10 300 250 12x23 12x23	180 356	338/-	266/-	125 286	149 450	400 225	379 523	19	566	-	648/-	197/-	200 150	625 500	450 20	180												
		45 294	C2	10 300 250 12x23 12x23	180 356	338/-	266/-	125 286	149 450	400 225	379 523	19	566	-	708/-	197/-	200 150	625 500	450 20	180												
		55 318	C2	10 300 250 12x23 12x23	180 406	410/-	319/-	125 349	168 450	400 250	379 523	24	566	-	747/-	233/-	200 150	625 500	550 20	180												
		75 362	C2	10 300 250 12x23 12x23	180 457	433/-	319/-	125 368	190 450	400 280	379 523	24	566	-	820/-	233/-	200 150	625 500	550 20	180												
		90 370	C2	10 300 250 12x23 12x23	180 457	433/-	319/-	125 368	190 450	400 280	379 523	24	566	-	930/-	233/-	200 150	625 500	550 20	180												
	6	11 277	C2	10 300 250 12x23 12x23	180 254	237/-	175/-	125 254	108 450	400 160	379 523	15	536	-	554/-	145/-	200 150	625 500	350 20	180												
		15 306	C2	10 300 250 12x23 12x23	180 279	286/-	189/-	125 241	121 450	400 180	379 523	15	536	-	588/-	164/-	200 150	625 500	350 20	180												
		18.5 330	C2	10 300 250 12x23 12x23	180 318	315/-	265/-	125 305	133 450	400 200	379 523	19	536	-	611/-	197/-	200 150	625 500	400 20	180												
		22 366	C2	10 300 250 12x23 12x23	180 318	315/-	265/-	125 305	133 450	400 200	379 523	19	536	-	636/-	197/-	200 150	625 500	400 20	180												
		45 281	C2	10 300 250 12x23 12x23	160 356	338/-	266/-	125 286	149 450	500 225	350 498	19	518	-	708/-	197/-	200 150	625 500	450 20	180												
250-400	4	55 301	C2	10 300 250 12x23 12x23	160 406	410/-	319/-	125 349	168 450	500 250	350 498	24	518	-	747/-	233/-	200 150	625 500	550 20	180												
		75 329	C2	10 300 250 12x23 12x23	160 457	433/-	319/-	125 368	190 450	500 280	350 498	24	518	-	820/-	233/-	200 150	625 500	550 20	180												
		90 349	C2	10 300 250 12x23 12x23	160 457	433/-	319/-	125 368	190 450	500 280	350 498	24	518	-	930/-	233/-	200 150	625 500	550 20	180												
		110 365	C2	10 300 250 12x23 12x23	160 508	515/-	374/-	125 406	216 450	500 315	350 498	28	548	-	912/-	299/-	200 150	625 500	660 20	180												
		132 385	C2	10 300 250 12x23 12x23	160 508	515/-	374/-	125 457	216 450	500 315	350 498	28	548	-	1077/-	299/-	200 150	625 500	660 20	180												
	6	160 405	C2	10 300 250 12x23 12x23	160 508	515/-	374/-	125 457	216 450	500 315	350 498	28	548	-	1077/-	299/-	200 150	625 500	660 20	180												
		15 289	C2	10 300 250 12x23 12x23	160 279	286/-	189/-	125 241	121 450	500 180	350 498	15	488	-	588/-	164/-	200 150	625 500	350 20	180												
		18.5 313	C2	10 300 250 12x23 12x23	160 318	315/-	265/-	125 305	133 450	500 200	350 498	19	488	-	611/-	197/-	200 150	625 500	400 20	180												
		22 329	C2	10 300 250 12x23 12x23	160 318	315/-	265/-	125 305	133 450	500 200	350 498	19	488	-	636/-	197/-	200 150	625 500	400 20	180												
		30 361	C2	10 300 250 12x23 12x23	160 356	338/-	266/-	125 286	149 450	500 225	350 498	19	518	-	708/-	197/-	200 150	625 500	450 20	180												
250-450	4	37 381	C2	10 300 250 12x23 12x23	160 406	410/-	319/-	125 349	168 450	500 250	350 498	24	518	-	747/-	233/-	200 150	625 500	550 20	180												
		45 401	C2	10 300 250 12x23 12x23	160 457	433/-	319/-	125 368	190 450	500 280	350 498	24	518	-	820/-	233/-	200 150	625 500	550 20	180												
		75 325	C2	10 300 250 12x23 12x23	165 457	433/-	319/-	125 368	190 450	500 280	374 563	24	521	-	820/-	233/-	200 150	625 500	550 20	180												
		90 341	C2	10 300 250 12x23 12x23	165 457	433/-	319/-	125 368	190 450	500 280	374 563	24	521	-	930/-	233/-	200 150	625 500	550 20	180												
		110 361	C2	10 300 250 12x23 12x23	165 508	515/-	374/-	125 406	216 450	500 315	374 563	28	551	-	912/-	299/-	200 150	625 500	660 20	180												
	6	132 381	C2	10 300 250 12x23 12x23	165 508	515/-	374/-	125 457	216 450	500 315	374 563	28	551	-	1077/-	299/-	200 150	625 500	660 20	180												
		160 401	C2	10 300 250 12x23 12x23	165 508	515/-	374/-	125 457	216 450	500 315	374 563	28	551	-	1077/-	299/-	200 150	625 500	660 20	180												
		200 445	C2	10 300 250 12x23 12x23	165 508	515/-	374/-	125 457	216 450	500 315	374 563	28	551	-	1232/-	299/-	200 150	625 500	660 20	180												
		18.5 313	C2	10 300 250 12x23 12x23	165 318	315/-	265/-	125 305	133 450	500 200	374 563	19	491	-	611/-	197/-	200 150	625 500	400 20	180												
		22 325	C2	10 300 250 12x23 12x23	165 318	315/-	265/-	125 305	133 450	500 200	374 563	19	491	-	636/-	197/-	200 150	625 500	400 20	180												
250-500	4	30 357	C2	10 300 250 12x23 12x23	165 356	338/-	266/-	125 286	149 450	500 225	374 563	19	521	-	708/-	197/-	200 150	625 500	450 20	180												
		37 377	C2	10 300 250 12x23 12x23	165 406	410/-	319/-	125 349	168 450	500 250	374 563	24	521	-	747/-	233/-	200 150	625 500	550 20	180												
		45 397	C2	10 300 250 12x23 12x23	165 457	433/-	319/-	125 368	190 450	500 280	374 563	24	521	-	820/-	233/-	200 150	625 500	550 20	180												
		55 433	C2	10 300 250 12x23 12x23	165 457	433/-	319/-	125 368	190 450	500 280	374 563	24	521	-	820/-	233/-	200 150	625 500	550 20	180												
		160 417	C2	10 300 250 12x23 12x23	165 508	515/-	374/-	125 457	216 450	500 315	441 598	28	574	-	1077/-	299/-	200 150	725 600	660 20	180												
	6	200 445	C2	10 300 250 12x23 12x23	165 508	515/-	374/-	125 457	216 450	500 315	441 598	28	574	-	1232/-	299/-	200 150	725 600	660 20	180												
		45 409	C2	10 300 250 12x23 12x23	165 457	433/-	319/-	125 368	190 450	500 280	441 598	24	549	-	820/-	233/-	200 150	725 600	550 20	180												
		55 437	C2	10 300 250 12x23 12x23	165 457	433/-	319/-	125 368	190 450	500 280	441 598	24	549	-	820/-	233/-	200 150	725 600	550 20	180												
		75 485	C2	10 300 250 12x23 12x23	165 508	515/-	374/-	125 406	216 450	500 315	441 598	28	574	-	912/-	299/-	200 150	725 600	660 20	180												
		90 525	C2	10 300 250 12x23 12x23	165 508	515/-	374/-	125 457	216 450	500 315	441 598	28	574	-	1077/-	299/-	200 150	725 600	660 20	180												

¹ Pump with standard motor or pump with E-motor.

² X: Service dimension.

Dimensional drawings, NK

C-channel base frame, center outlet

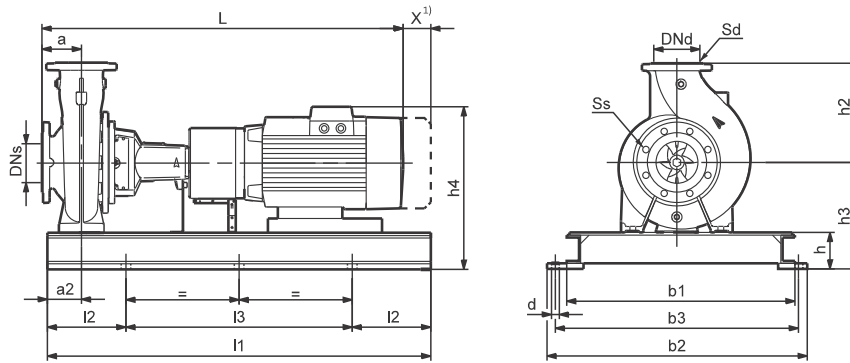

TM03 4051 2415

C-channel base frame, tangential outlet

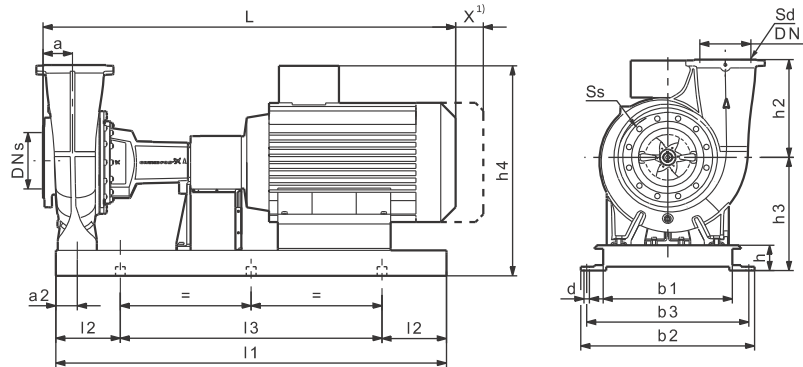

TM04 6113 2415

EN/ISO base frame, center outlet

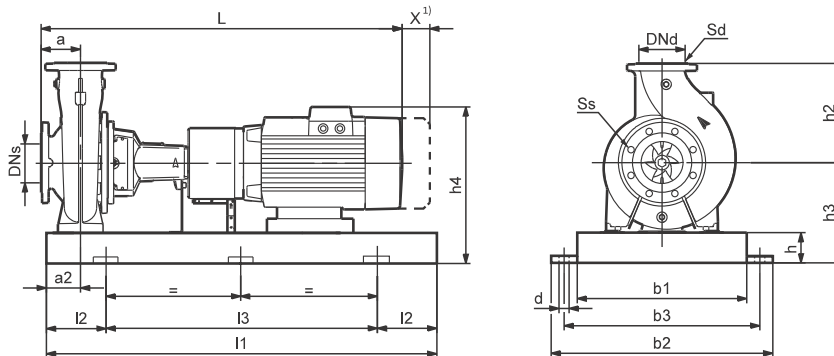

TM03 4179 2415

EN/ISO base frame, tangential outlet

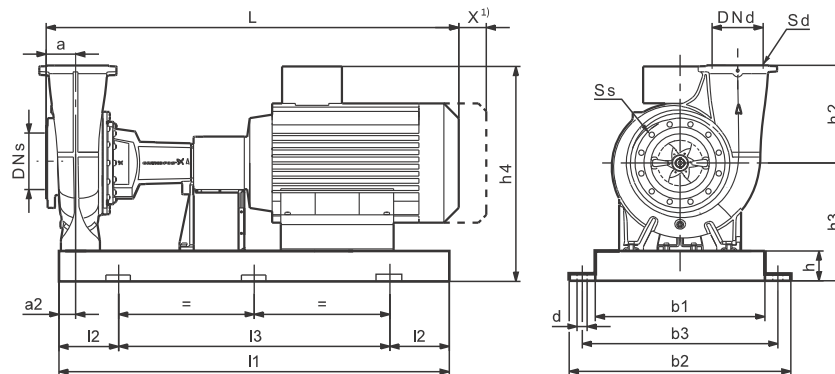

TM03 6005 2415

¹ X: Service dimension. This dimension can be found in section 13. *NK bare-shaft pumps*, it equals to the length of the spacer coupling.

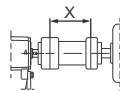

Technical data, NK

Standard motors in this table are IE3 motors:

- 2-pole: P2 less than or equal to 22 kW, pump with MG motor; P2 greater than or equal to 30 kW, pump with Siemens motor.
- 4-pole: P2 less than or equal to 15 kW, pump with MG motor; P2 greater than or equal to 18.5 kW, pump with Siemens motor.
- 6-pole: Pump with Siemens motor.

E-motors in this table:

- 2-pole: P2 less than or equal to 22 kW, pump with MGE motor.
- 4-pole: P2 less than or equal to 18.5 kW, pump with MGE motor.

Pump size	Poles	P2 [kW]	Actual impeller size	Flanges					NK dimensions [mm]						Base frame No ³⁾				
				PN	DNs	DNd	Ss	Sd	a	a2	h2	h3	h4 ²⁾	L ¹⁾		EN/ISO		C- channel	
														NK	NKE	Standard coupling	Spacer coupling	Standard coupling	Spacer coupling
32-125.1	2	0.75	100	16	50	32	4x19	4x19	80	60	140	177	286/-	715/811	-/-	2 st	2	2	2s
		1.1	110	16	50	32	4x19	4x19	80	60	140	177	286/335	735/831	758/854	2 st	2	2	2s
		1.5	121	16	50	32	4x19	4x19	80	60	140	180	286/361	775/871	768/864	2 st	2	5	5s
	4	2.2	140	16	50	32	4x19	4x19	80	60	140	180	286/361	815/911	768/864	3-B st	3	5	5s
		0.25	121	16	50	32	4x19	4x19	80	60	140	177	286/-	675/761	-/-	2 st	2	1	1s
		0.25	139	16	50	32	4x19	4x19	80	60	140	177	286/-	675/761	-/-	2 st	2	1	1s
32-125	2	0.37	140	16	50	32	4x19	4x19	80	60	140	177	286/-	675/761	-/-	2 st	2	1	1s
		1.1	106	16	50	32	4x19	4x19	80	60	140	177	286/335	735/831	758/854	2 st	2	2	2s
		1.5	115	16	50	32	4x19	4x19	80	60	140	180	286/361	775/871	768/864	2 st	2	5	5s
	4	2.2	130	16	50	32	4x19	4x19	80	60	140	180	286/361	815/911	768/864	3-B st	3	5	5s
		3	142	16	50	32	4x19	4x19	80	60	140	177	297/378	839/935	770/866	3 st	3	9	9s
		0.25	115	16	50	32	4x19	4x19	80	60	140	177	286/-	675/761	-/-	2 st	2	1	1s
32-160.1	2	0.25	130	16	50	32	4x19	4x19	80	60	140	177	286/-	675/761	-/-	2 st	2	1	1s
		0.37	142	16	50	32	4x19	4x19	80	60	140	177	286/-	675/761	-/-	2 st	2	1	1s
		1.5	139	16	50	32	4x19	4x19	80	60	160	212	318/393	775/871	768/864	4-B st	4	5	5s
	4	2.2	155	16	50	32	4x19	4x19	80	60	160	212	318/393	815/911	768/864	4-B st	4	5	5s
		3	169	16	50	32	4x19	4x19	80	60	160	212	332/413	839/935	770/866	4-B st	4	9	9s
		4	177	16	50	32	4x19	4x19	80	60	160	212	346/413	876/972	770/866	4-B st	4	14	14s
32-160	2	0.25	137	16	50	32	4x19	4x19	80	60	160	212	321/-	675/761	-/-	4-B st	4	1	1s
		0.25	155	16	50	32	4x19	4x19	80	60	160	212	321/-	675/761	-/-	4-B st	4	1	1s
		0.37	172	16	50	32	4x19	4x19	80	60	160	212	321/-	675/761	-/-	4-B st	4	1	1s
	4	0.55	177	16	50	32	4x19	4x19	80	60	160	212	321/370	715/811	758/854	4-B st	4	2	2s
		2.2	139	16	50	32	4x19	4x19	80	60	160	212	318/393	815/911	768/864	4-B st	4	5	5s
		3	151	16	50	32	4x19	4x19	80	60	160	212	332/413	839/935	770/866	4-B st	4	9	9s
32-200.1	2	4	163	16	50	32	4x19	4x19	80	60	160	212	346/413	876/972	770/866	4-B st	4	14	14s
		5.5	177	16	50	32	4x19	4x19	80	60	160	215	349/416	921/1011	807/897	5 st	5	19	19s
		0.25	138	16	50	32	4x19	4x19	80	60	160	212	321/-	675/761	-/-	4-B st	4	1	1s
	4	0.37	154	16	50	32	4x19	4x19	80	60	160	212	321/-	675/761	-/-	4-B st	4	1	1s
		0.55	172	16	50	32	4x19	4x19	80	60	160	212	321/370	715/811	758/854	4-B st	4	2	2s
		0.75	173	16	50	32	4x19	4x19	80	60	160	212	318/386	765/861	718/814	4-B st	4	5	5s
32-200	2	3	172	16	50	32	4x19	4x19	80	60	180	240	360/441	839/935	770/866	4-B st	4	9	9s
		4	188	16	50	32	4x19	4x19	80	60	180	240	374/441	876/972	770/866	4-B st	4	14	14s
		5.5	205	16	50	32	4x19	4x19	80	60	180	240	374/441	921/1011	807/897	5 st	5	19	19s
	4	7.5	207	16	50	32	4x19	4x19	80	60	180	240	399/477	909/999	831/921	5 st	5	19	19s
		0.37	175	16	50	32	4x19	4x19	80	60	180	240	349/-	675/761	-/-	4-B st	4	1	1s
		0.55	196	16	50	32	4x19	4x19	80	60	180	240	349/398	715/811	758/854	4-B st	4	3	3s
32-250	2	0.75	207	16	50	32	4x19	4x19	80	60	180	240	346/414	765/861	718/814	4-B st	4	6	6s
		4	176	16	50	32	4x19	4x19	80	60	180	240	374/441	876/972	770/866	4-B st	4	14	14s
		5.5	190	16	50	32	4x19	4x19	80	60	180	240	374/441	921/1011	807/897	5 st	5	19	19s
	4	7.5	206	16	50	32	4x19	4x19	80	60	180	240	399/477	909/999	831/921	5 st	5	19	19s
		11	219	16	50	32	4x19	4x19	80	60	180	245	449/482	1038/1121	855/938	6-B st	6	32	32s
		0.55	184	16	50	32	4x19	4x19	80	60	180	240	349/398	715/811	758/854	4-B st	4	3	3s
32-250	2	0.75	197	16	50	32	4x19	4x19	80	60	180	240	346/414	765/861	718/814	4-B st	4	6	6s
		1.1	216	16	50	32	4x19	4x19	80	60	180	240	346/421	775/871	768/864	4-B st	4	6	6s
		1.5	219	16	50	32	4x19	4x19	80	60	180	240	350/398	815/911	710/806	4-B st	4	6	6s
	4	5.5	199	16	50	32	4x19	4x19	100	75	225	260	394/461	941/1031	827/917	5 st	5	20	20s
		7.5	219	16	50	32	4x19	4x19	100	75	225	260	419/497	929/1019	851/941	5 st	5	20	20s
		11	244	16	50	32	4x19	4x19	100	75	225	260	464/497	1058/1141	875/958	6 st	6	32	32s
32-250	2	15	262	16	50	32	4x19	4x19	100	75	225	260	464/561	1058/1141	1058/1141	6 st	6	32	32s
		0.75	206	16	50	32	4x19	4x19	100	75	225	260	366/434	785/881	738/834	5 st	5	6	6s
	4	1.1	236	16	50	32	4x19	4x19	100	75	225	260	366/441	795/891	788/884	5 st	5	6	6s
		1.5	260	16	50	32	4x19	4x19	100	75	225	260	370/418	835/931	730/826	5 st	5	6	6s
		2.2	262	16	50	32	4x19	4x19	100	75	225	260	380/461	859/955	790/886	5 st	5	10	10s

¹ Pump with standard coupling or pump with spacer coupling.

² Pump with standard motor or pump with E-motor.

³ EN/ISO base frame, see page 153. C-channel base frame, see page 154.

Pump size	Poles	P2 [kW]	Actual impeller size	Flanges			NK dimensions [mm]						Base frame No ³⁾						
				PN	DNs	DNd	Ss	Sd	a	a2	h2	h3	h4 ²⁾	L ¹⁾		EN/ISO		C- channel	
														NK	NKE	Standard coupling	Spacer coupling	Standard coupling	Spacer coupling
40-125	2	1.5	105	16	65	40	4x19	4x19	80	60	140	180	286/361	775/871	768/864	3-B st	3	5	5s
		2.2	116	16	65	40	4x19	4x19	80	60	140	180	286/361	815/911	768/864	3-B st	3	5	5s
		3	127	16	65	40	4x19	4x19	80	60	140	177	297/378	839/935	770/866	3 st	3	9	9s
	4	4	139	16	65	40	4x19	4x19	80	60	140	195	329/396	876/972	770/866	4-B st	4	14	14s
		5.5	142	16	65	40	4x19	4x19	80	60	140	217	351/418	921/1011	807/897	5 st	5	19	19s
		0.25	116	16	65	40	4x19	4x19	80	60	140	177	286/-	675/761	-/-	3-B st	3	1	1s
		0.37	130	16	65	40	4x19	4x19	80	60	140	177	286/-	675/761	-/-	3-B st	3	1	1s
40-160	2	4	144	16	65	40	4x19	4x19	80	60	160	212	346/413	876/972	770/866	4-B st	4	14	14s
		5.5	158	16	65	40	4x19	4x19	80	60	160	215	349/416	921/1011	807/897	5 st	5	19	19s
		7.5	172	16	65	40	4x19	4x19	80	60	160	215	374/452	909/999	831/921	5 st	5	19	19s
	4	11	177	16	65	40	4x19	4x19	80	60	160	245	449/482	1038/1121	855/938	6-B st	6	31	31s
		0.37	134	16	65	40	4x19	4x19	80	60	160	212	321/-	675/761	-/-	4-B st	4	1	1s
		0.55	151	16	65	40	4x19	4x19	80	60	160	212	321/370	715/811	758/854	4-B st	4	2	2s
		0.75	162	16	65	40	4x19	4x19	80	60	160	212	318/386	765/861	718/814	4-B st	4	5	5s
40-200	2	1.1	177	16	65	40	4x19	4x19	80	60	160	212	318/393	775/871	768/864	4-B st	4	5	5s
		5.5	172	16	65	40	4x19	4x19	100	60	180	240	374/441	941/1031	827/917	5 st	5	19	19s
		7.5	188	16	65	40	4x19	4x19	100	60	180	240	399/477	929/1019	851/941	5 st	5	19	19s
	4	11	206	16	65	40	4x19	4x19	100	60	180	245	449/482	1058/1141	875/958	6-B st	6	32	32s
		15	219	16	65	40	4x19	4x19	100	60	180	245	449/546	1058/1141	1058/1141	6-B st	6	32	32s
		0.75	177	16	65	40	4x19	4x19	100	60	180	240	346/414	785/881	718/814	4-B st	4	6	6s
		1.1	198	16	65	40	4x19	4x19	100	60	180	240	346/421	795/891	788/884	4-B st	4	6	6s
40-250	2	1.5	217	16	65	40	4x19	4x19	100	60	180	240	350/398	835/931	730/826	4-B st	4	6	6s
		2.2	219	16	65	40	4x19	4x19	100	60	180	240	360/441	859/955	790/886	4-B st	4	9	9s
		11	211	16	65	40	4x19	4x19	100	75	225	260	464/497	1058/1141	875/958	6 st	6	32	32s
	4	15	230	16	65	40	4x19	4x19	100	75	225	260	464/561	1058/1141	1058/1141	6 st	6	32	32s
		18.5	245	16	65	40	4x19	4x19	100	75	225	260	464/561	1102/1185	1102/1185	6 st	6	32	32s
		22	255	16	65	40	4x19	4x19	100	75	225	265	469/627	1139/1214	1136/1211	6 st	6	33	33s
		30	260	16	65	40	4x19	4x19	100	75	225	305	620/-	1206/1281	-/-	8 st	8	41	41s
40-315	2	1.5	219	16	65	40	4x19	4x19	100	75	225	260	370/418	835/931	730/826	5 st	5	6	6s
		2.2	245	16	65	40	4x19	4x19	100	75	225	260	380/461	859/955	790/886	5 st	5	10	10s
		3	260	16	65	40	4x19	4x19	100	75	225	260	380/461	859/955	790/886	5 st	5	10	10s
	4	22	273	16	65	40	4x19	4x19	125	75	250	280	484/642	1253/1349	1250/1346	6 st	6	34	34s
		30	298	16	65	40	4x19	4x19	125	75	250	305	620/-	1320/1416	-/-	8 st	8	111	111s
		37	318	16	65	40	4x19	4x19	125	75	250	305	620/-	1345/1441	-/-	8 st	8	111	111s
		45	336	16	65	40	4x19	4x19	125	75	250	330	668/-	1417/1513	-/-	8-B st	8	52	52s
50-125	2	3	283	16	65	40	4x19	4x19	125	75	250	280	400/481	994/1090	924/1020	6 st	6	11	11s
		4	305	16	65	40	4x19	4x19	125	75	250	280	414/481	1031/1127	924/1020	6 st	6	16	16s
		5.5	334	16	65	40	4x19	4x19	125	75	250	280	439/517	1058/1154	979/1075	6 st	6	21	21As
	4	7.5	344	16	65	40	4x19	4x19	125	75	250	280	439/517	1108/1204	979/1075	6 st	6	21	21As
		3	111	16	65	50	4x19	4x19	100	60	160	212	332/413	859/955	790/886	4-B st	4	9	9s
		4	121	16	65	50	4x19	4x19	100	60	160	212	346/413	896/992	790/886	4-B st	4	14	14s
		5.5	135	16	65	50	4x19	4x19	100	60	160	215	349/416	941/1031	827/917	5 st	5	19	19s
50-160	2	7.5	144	16	65	50	4x19	4x19	100	60	160	215	374/452	929/1019	851/941	5 st	5	19	19s
		0.37	113	16	65	50	4x19	4x19	100	60	160	212	321/-	695/781	-/-	4-B st	4	1	1s
		0.55	129	16	65	50	4x19	4x19	100	60	160	212	321/370	735/831	778/874	4-B st	4	2	2s
	4	0.75	138	16	65	50	4x19	4x19	100	60	160	212	318/386	785/881	738/834	4-B st	4	5	5s
		1.1	144	16	65	50	4x19	4x19	100	60	160	212	318/393	795/891	788/884	4-B st	4	5	5s
		5.5	136	16	65	50	4x19	4x19	100	60	180	240	374/441	941/1031	827/917	5 st	5	19	19s
		7.5	150	16	65	50	4x19	4x19	100	60	180	240	399/477	929/1019	851/941	5 st	5	19	19s
50-200	2	11	167	16	65	50	4x19	4x19	100	60	180	245	449/482	1058/1141	875/958	6-B st	6	32	32s
		15	177	16	65	50	4x19	4x19	100	60	180	245	449/546	1058/1141	1058/1141	6-B st	6	32	32s
		0.55	131	16	65	50	4x19	4x19	100	60	180	240	349/398	735/831	778/874	4-B st	4	3	3s
	4	0.75	139	16	65	50	4x19	4x19	100	60	180	240	346/414	785/881	738/834	4-B st	4	6	6s
		1.1	158	16	65	50	4x19	4x19	100	60	180	240	346/421	795/891	788/884	4-B st	4	6	6s
		1.5	175	16	65	50	4x19	4x19	100	60	180	240	350/398	835/931	730/826	4-B st	4	6	6s
		2.2	177	16	65	50	4x19	4x19	100	60	180	240	360/441	859/955	790/886	4-B st	4	9	9s
4	11	181	16	65	50	4x19	4x19	100	60	200	245	449/482	1058/1141	875/958	6-B st	6	32	32s	
	15	198	16	65	50	4x19	4x19	100	60	200	245	449/546	1058/1141	1058/1141	6-B st	6	32	32s	
	18.5	210	16	65	50	4x19	4x19	100	60	200	245	449/546	1102/1185	1102/1185	6-B st	6	32	32s	
	22	219	16	65	50	4x19	4x19	100	60	200	265	469/627	1139/1214	1136/1211	6-B st	6	33	33s	
	1.1	171	16	65	50	4x19	4x19	100	60	200	240	346/421	795/891	788/884	4-B st	4	6	6s	
4	1.5	188	16	65	50	4x19	4x19	100	60	200	240	350/398	835/931	730/826	4-B st	4	6	6s	
	2.2	210	16	65	50	4x19	4x19	100	60	200	240	360/441	859/955	790/886	4-B st	4	9	9s	
	3	219	16	65	50	4x19	4x19	100	60	200	240	360/441	859/955	790/886	4-B st	4	9	9s	

¹ Pump with standard coupling or pump with spacer coupling.
² Pump with standard motor or pump with E-motor.
³ EN/ISO base frame, see page 153. C-channel base frame, see page 154.

Pump size	Poles	P2 [kW]	Actual impeller size	Flanges				NK dimensions [mm]						Base frame No ³⁾					
				PN	DNs	DNd	Ss	Sd	a	a2	h2	h3	h4 ²⁾	L ¹⁾		EN/ISO		C- channel	
														NK	NKE	Standard coupling	Spacer coupling	Standard coupling	Spacer coupling
50-250	2	15	205	16	65	50	4x19	4x19	100	75	225	260	464/561	1058/1141	1058/1141	6 st	6	32	32s
		18.5	222	16	65	50	4x19	4x19	100	75	225	260	464/561	1102/1185	1102/1185	6 st	6	32	32s
		22	233	16	65	50	4x19	4x19	100	75	225	265	469/627	1139/1214	1136/1211	6 st	6	33	33s
		30	254	16	65	50	4x19	4x19	100	75	225	305	620/-	1206/1281	-/-	8 st	8	41	41s
		37	263	16	65	50	4x19	4x19	100	75	225	305	620/-	1231/1306	-/-	8 st	8	41	41s
	4	2.2	221	16	65	50	4x19	4x19	100	75	225	260	380/461	859/955	790/886	5 st	5	10	10s
		3	241	16	65	50	4x19	4x19	100	75	225	260	380/461	859/955	790/886	5 st	5	10	10s
		4	263	16	65	50	4x19	4x19	100	75	225	260	394/461	896/992	790/886	5 st	5	15	15s
		30	267	16	65	50	4x19	4x19	125	75	280	325	640/-	1320/1416	-/-	8 st	8	42	42s
		37	285	16	65	50	4x19	4x19	125	75	280	325	640/-	1345/1441	-/-	8 st	8	42	42s
50-315	2	45	300	16	65	50	4x19	4x19	125	75	280	330	668/-	1417/1513	-/-	8-B st	8	52	52s
		55	321	16	65	50	4x19	4x19	125	75	280	355	765/-	1486/1582	-/-	9-C st	9	60	60s
		4	277	16	65	50	4x19	4x19	125	75	280	305	439/506	1031/1127	924/1020	6 st	6	17	17s
		5.5	303	16	65	50	4x19	4x19	125	75	280	305	464/542	1058/1154	979/1075	6 st	6	22	22s
		7.5	331	16	65	50	4x19	4x19	125	75	280	305	464/542	1108/1204	979/1075	6 st	6	22	22s
	4	11	344	16	65	50	4x19	4x19	125	75	280	305	509/606	1254/1350	1180/1276	6 st	6	28	28s
		4	120-110	16	80	65	8x19	4x19	100	60	180	240	374/441	896/992	790/886	4-B st	4	14	14s
		5.5	127	16	80	65	8x19	4x19	100	60	180	240	374/441	941/1031	827/917	5 st	5	19	19s
		7.5	137	16	80	65	8x19	4x19	100	60	180	240	399/477	929/1019	851/941	5 st	5	19	19s
		11	144	16	80	65	8x19	4x19	100	60	180	245	449/482	1058/1141	875/958	6-B st	6	32	32s
65-125	2	0.55	122	16	80	65	8x19	4x19	100	60	180	240	349/398	735/831	778/874	4-B st	4	3	3s
		0.75	130	16	80	65	8x19	4x19	100	60	180	240	346/414	785/881	738/834	4-B st	4	6	6s
		1.1	144	16	80	65	8x19	4x19	100	60	180	240	346/421	795/891	788/884	4-B st	4	6	6s
		7.5	143	16	80	65	8x19	4x19	100	60	200	240	399/477	929/1019	851/941	5 st	5	19	19s
		11	157	16	80	65	8x19	4x19	100	60	200	245	449/482	1058/1141	875/958	6-B st	6	32	32s
	4	15	173	16	80	65	8x19	4x19	100	60	200	245	449/546	1058/1141	1058/1141	6-B st	6	32	32s
		18.5	177	16	80	65	8x19	4x19	100	60	200	245	449/546	1102/1185	1102/1185	6-B st	6	32	32s
		0.75	135	16	80	65	8x19	4x19	100	60	200	240	346/414	785/881	738/834	4-B st	4	6	6s
		1.1	149	16	80	65	8x19	4x19	100	60	200	240	346/421	795/891	788/884	4-B st	4	6	6s
		1.5	165	16	80	65	8x19	4x19	100	60	200	240	350/398	835/931	730/826	4-B st	4	6	6s
65-160	2	2.2	177	16	80	65	8x19	4x19	100	60	200	240	360/441	859/955	790/886	4-B st	4	9	9s
		11	162	16	80	65	8x19	4x19	100	75	225	260	464/497	1058/1181	875/998	6 st	6	32	32s
		15	177	16	80	65	8x19	4x19	100	75	225	260	464/561	1058/1181	1058/1181	6 st	6	32	32s
		18.5	190	16	80	65	8x19	4x19	100	75	225	260	464/561	1102/1225	1102/1225	6 st	6	32	32s
		22	198	16	80	65	8x19	4x19	100	75	225	265	469/627	1139/1254	1136/1251	6 st	6	33	33s
	4	30	217	16	80	65	8x19	4x19	100	75	225	305	620/-	1206/1321	-/-	8 st	8	41	41s
		37	219	16	80	65	8x19	4x19	100	75	225	305	620/-	1231/1346	-/-	8 st	8	41	41s
		1.5	170	16	80	65	8x19	4x19	100	75	225	260	370/418	835/971	730/866	5 st	5	6	6As
		2.2	189	16	80	65	8x19	4x19	100	75	225	260	380/461	859/995	790/926	5 st	5	10	10s
		3	205	16	80	65	8x19	4x19	100	75	225	260	380/461	859/995	790/926	5 st	5	10	10s
65-200	2	4	219	16	80	65	8x19	4x19	100	75	225	260	394/461	896/1032	790/926	5 st	5	15	15s
		30	223	16	80	65	8x19	4x19	100	90	250	305	620/-	1295/1431	-/-	8 st	8	111	111s
		37	238	16	80	65	8x19	4x19	100	90	250	305	620/-	1320/1456	-/-	8 st	8	111	111s
		45	251	16	80	65	8x19	4x19	100	90	250	330	668/-	1392/1528	-/-	8-B st	8	52	52s
		55	269	16	80	65	8x19	4x19	100	90	250	360	770/-	1461/1597	-/-	9-C st	9	60	60s
	4	75	270	16	80	65	8x19	4x19	100	90	250	415	848/-	1534/1670	-/-	10-C st	10	73	73s
		3	215	16	80	65	8x19	4x19	100	90	250	280	400/481	969/1105	899/1035	6 st	6	11	11s
		4	232	16	80	65	8x19	4x19	100	90	250	280	414/481	1006/1142	899/1035	6 st	6	16	16s
		5.5	254	16	80	65	8x19	4x19	100	90	250	280	439/517	1033/1169	954/1090	6 st	6	21	21s
		7.5	270	16	80	65	8x19	4x19	100	90	250	280	439/517	1083/1219	954/1090	6 st	6	21	21s
65-250	2	55	272	16	80	65	8x19	4x19	125	90	280	355	765/-	1486/1622	-/-	9-C st	9	60	60s
		75	295	16	80	65	8x19	4x19	125	90	280	415	848/-	1559/1695	-/-	10-C st	10	73	73s
		90	308	16	80	65	8x19	4x19	125	90	280	415	848/-	1669/1805	-/-	10-C st	10	69	69s
		110	320	16	80	65	8x19	4x19	125	90	280	455	970/-	1651/1787	-/-	10-C st	10	76	76s
		5.5	261	16	80	65	8x19	4x19	125	90	280	325	484/562	1058/1194	979/1115	7 st	7	22	22s
	4	7.5	282	16	80	65	8x19	4x19	125	90	280	325	484/562	1108/1244	979/1115	7 st	7	22	22s
		11	314	16	80	65	8x19	4x19	125	90	280	325	529/626	1254/1390	1180/1316	7-B st	7	28	28s
		15	320	16	80	65	8x19	4x19	125	90	280	325	529/626	1284/1420	1224/1360	7-B st	7	28	28s
		11	147-127	16	100	80	8x19	8x19	125	75	225	260	464/497	1083/1206	900/1023	6 st	6	32	32s
		15	151	16	100	80	8x19	8x19	125	75	225	260	464/561	1083/1206	1083/1206	6 st	6	32	32s
80-160	2	18.5	161	16	100	80	8x19	8x19	125	75	225	260	464/561	1127/1250	1127/1250	6 st	6	32	32s
		22	167	16	100	80	8x19	8x19	125	75	225	265	469/627	1164/1279	1161/1276	6 st	6	33	33s
		30	177	16	100	80	8x19	8x19	125	75	225	305	620/-	1231/1346	-/-	8 st	8	41	41s
		1.5	146	16	100	80	8x19	8x19	125	75	225	260	370/418	860/996	755/891	5 st	5	6	6As
		2.2	161	16	100	80	8x19	8x19	125	75	225	260	380/461	884/1020	815/951	5 st	5	10	10s
	4	3	175	16	100	80	8x19	8x19	125	75	225	260	380/461	884/1020	815/951	5 st	5	10	10s
		4	177	16	100	80	8x19	8x19	125	75	225	260	394/461	921/1057	815/951	5 st	5	15	15s

1 Pump with standard coupling or pump with spacer coupling.

2 Pump with standard motor or pump with E-motor.

3 EN/ISO base frame, see page 153. C-channel base frame, see page 154.

Pump size	Poles	P2 [kW]	Actual impeller size	Flanges			NK dimensions [mm]					Base frame No ³⁾							
				PN	DNs	DNd	Ss	Sd	a	a2	h2	h3	h4 ²⁾	L ¹⁾		EN/ISO		C- channel	
														NK	NKE	Standard coupling	Spacer coupling	Standard coupling	Spacer coupling
80-200	2	22	171	16	100	80	8x19	8x19	125	75	250	265	469/627	1253/1389	1250/1386	6 st	6	34	34s
		30	188	16	100	80	8x19	8x19	125	75	250	305	620/-	1320/1456	-/-	8 st	8	111	111s
		37	200	16	100	80	8x19	8x19	125	75	250	305	620/-	1345/1481	-/-	8 st	8	111	111s
		45	211	16	100	80	8x19	8x19	125	75	250	330	668/-	1417/1553	-/-	8-B st	8	51	51s
		55	222	16	100	80	8x19	8x19	125	75	250	355	765/-	1486/1622	-/-	9-C st	9	59	59s
	4	2.2	164	16	100	80	8x19	8x19	125	75	250	260	380/461	994/1130	924/1060	6 st	6	11	11s
		3	179	16	100	80	8x19	8x19	125	75	250	260	380/461	994/1130	924/1060	6 st	6	11	11s
		4	196	16	100	80	8x19	8x19	125	75	250	260	394/461	1031/1167	924/1060	6 st	6	16	16s
		5.5	214	16	100	80	8x19	8x19	125	75	250	260	419/497	1058/1194	979/1115	6 st	6	21	21s
		7.5	222	16	100	80	8x19	8x19	125	75	250	260	419/497	1108/1244	979/1115	6 st	6	21	21s
80-250	2	45	220	16	100	80	8x19	8x19	125	90	280	330	668/-	1417/1553	-/-	8-B st	8	52	52s
		55	234	16	100	80	8x19	8x19	125	90	280	360	770/-	1486/1622	-/-	9-C st	9	60	60s
		75	257	16	100	80	8x19	8x19	125	90	280	415	848/-	1559/1695	-/-	10-C st	10	73	73s
		90	270	16	100	80	8x19	8x19	125	90	280	415	848/-	1669/1805	-/-	10-C st	10	69	69s
		5.5	225	16	100	80	8x19	8x19	125	90	280	300	459/537	1058/1194	979/1115	7 st	7	21	21s
	4	7.5	247	16	100	80	8x19	8x19	125	90	280	300	459/537	1108/1244	979/1115	7 st	7	21	21s
		11	270	16	100	80	8x19	8x19	125	90	280	300	504/601	1254/1390	1180/1316	7-B st	7	27	27s
		90	278	16	100	80	8x19	8x19	125	90	315	415	848/-	1669/1805	-/-	10-C st	10	69	69s
		110	295	16	100	80	8x19	8x19	125	90	315	450	965/-	1651/1787	-/-	10-C st	10	76	76s
		132	310	16	100	80	8x19	8x19	125	90	315	450	965/-	1816/1952	-/-	10-C st	10	76	76s
80-315	2	160	328	16	100	80	8x19	8x19	125	90	315	450	965/-	1876/2012	-/-	10-C st	10	82	82s
		11	280	16	100	80	8x19	8x19	125	90	315	350	554/651	1254/1390	1180/1316	7-B st	7	28	28s
		15	305	16	100	80	8x19	8x19	125	90	315	350	554/651	1284/1420	1224/1360	7-B st	7	28	28s
		18.5	320	16	100	80	8x19	8x19	125	90	315	350	636/658	1267/1403	1250/1386	7-B st	7	35	35s
		22	334	16	100	80	8x19	8x19	125	90	315	350	636/-	1297/1433	-/-	7-B st	7	35	35s
	4	18.5	347	16	100	80	8x19	8x19	125	90	355	380	669/691	1327/1463	1310/1446	8 st	8	36	36s
		22	365	16	100	80	8x19	8x19	125	90	355	380	669/-	1357/1493	-/-	8 st	8	36	36s
		30	397	16	100	80	8x19	8x19	125	90	355	380	695/-	1405/1541	-/-	8 st	8	43	43s
		37	419	16	100	80	8x19	8x19	125	90	355	380	718/-	1447/1583	-/-	8-B st	8	53	53s
		45	438	16	100	80	8x19	8x19	125	90	355	380	718/-	1507/1643	-/-	8-B st	8	53	53s
80-400	2	18.5	160-154	16	125	100	8x19	8x19	125	90	280	280	464/561	1127/1250	1127/1250	6 st	6	32	32s
		22	167	16	125	100	8x19	8x19	125	90	280	280	484/642	1164/1279	1161/1276	6 st	6	33	33s
		30	176	16	125	100	8x19	8x19	125	90	280	305	620/-	1256/1371	-/-	8 st	8	41	41s
		2.2	160-140	16	125	100	8x19	8x19	125	90	280	280	400/481	884/1020	815/951	6 st	6	10	10s
		3	169	16	125	100	8x19	8x19	125	90	280	280	400/481	884/1020	815/951	6 st	6	10	10s
	4	4	176	16	125	100	8x19	8x19	125	90	280	280	414/481	921/1057	815/951	6 st	6	15	15s
		0.55	160-140	16	125	100	8x19	8x19	125	90	280	280	400/-	763/899	-/-	6 st	6	3	3As
		0.75	169	16	125	100	8x19	8x19	125	90	280	280	408/-	820/956	-/-	6 st	6	6	6As
		1.1	176	16	125	100	8x19	8x19	125	90	280	280	408/-	865/1001	-/-	6 st	6	6	6As
		30	170	16	125	100	8x19	8x19	125	90	280	305	620/-	1320/1456	-/-	8 st	8	111	111s
100-160	2	37	181	16	125	100	8x19	8x19	125	90	280	305	620/-	1345/1481	-/-	8 st	8	111	111s
		45	192	16	125	100	8x19	8x19	125	90	280	330	668/-	1417/1553	-/-	8-B st	8	52	52s
		55	203	16	125	100	8x19	8x19	125	90	280	360	770/-	1486/1622	-/-	9-C st	9	60	60s
		75	219	16	125	100	8x19	8x19	125	90	280	415	848/-	1559/1695	-/-	10-C st	10	73	73s
		4	178	16	125	100	8x19	8x19	125	90	280	280	414/481	1031/1167	1060/1060	6 st	6	16	16s
	4	5.5	195	16	125	100	8x19	8x19	125	90	280	280	439/517	1058/1194	1115/1115	6 st	6	21	21s
		7.5	211	16	125	100	8x19	8x19	125	90	280	280	439/517	1108/1244	1115/1115	6 st	6	21	21s
		11	219	16	125	100	8x19	8x19	125	90	280	280	484/581	1254/1390	1180/1316	7-B st	6	27	27s
		1.1	182	16	125	100	8x19	8x19	125	90	280	280	408/-	975/1111	-/-	6 st	6	7	7s
		1.5	193	16	125	100	8x19	8x19	125	90	280	280	446/-	995/1131	-/-	6 st	6	11	11s
100-200	6	2.2	214	16	125	100	8x19	8x19	125	90	280	280	457/-	1013/1149	-/-	6 st	6	16	16s
		3	219	16	125	100	8x19	8x19	125	90	280	280	482/-	1064/1200	-/-	6 st	6	21	21s
		55	205	16	125	100	8x19	8x19	140	90	280	355	765/-	1501/1637	-/-	9-C st	9	60	60s
		75	229	16	125	100	8x19	8x19	140	90	280	415	848/-	1574/1710	-/-	10-C st	10	73	73s
		90	242	16	125	100	8x19	8x19	140	90	280	415	848/-	1684/1820	-/-	10-C st	10	69	69s
	2	110	258	16	125	100	8x19	8x19	140	90	280	455	970/-	1666/1802	-/-	10-C st	10	76	76s
		132	274	16	125	100	8x19	8x19	140	90	280	455	970/-	1831/1967	-/-	10-C st	10	76	76s
		7.5	215	16	125	100	8x19	8x19	140	90	280	325	484/562	1123/1259	994/1130	7 st	7	22	22s
		11	245	16	125	100	8x19	8x19	140	90	280	325	529/626	1269/1405	1195/1331	7-B st	7	28	28s
		15	274	16	125	100	8x19	8x19	140	90	280	325	529/626	1299/1435	1239/1375	7-B st	7	28	28s
100-250	6	2.2	216	16	125	100	8x19	8x19	140	90	280	325	502/-	1028/1164	-/-	7 st	7	17	17s
		3	236	16	125	100	8x19	8x19	140	90	280	325	527/-	1079/1215	-/-	7 st	7	22	22s
		4	260	16	125	100	8x19	8x19	140	90	280	325	527/-	1079/1215	-/-	7 st	7	22	22s
		5.5	274	16	125	100	8x19	8x19	140	90	280	325	527/-	1129/1265	-/-	7 st	7	22	22s
		75	229	16	125	100	8x19	8x19	140	90	280	415	848/-	1574/1710	-/-	10-C st	10	73	73s

1 Pump with standard coupling or pump with spacer coupling.

2 Pump with standard motor or pump with E-motor.

3 EN/ISO base frame, see page 153. C-channel base frame, see page 154.

Pump size Poles	P2 [kW]	Actual impeller size	Flanges					NK dimensions [mm]					Base frame No ³⁾						
			PN	DNs	DNd	Ss	Sd	a	a2	h2	h3	h4 ²⁾	L ¹⁾		EN/ISO		C- channel		
													NK	NKE	Standard coupling	Spacer coupling	Standard coupling	Spacer coupling	
100-315	2	110	269	16	125	100	8x19	8x19	140	90	315	450	965/-	1666/1802	-/-	10-C st	10	76	76s
		132	284	16	125	100	8x19	8x19	140	90	315	450	965/-	1831/1967	-/-	10-C st	10	76	76s
		160	301	16	125	100	8x19	8x19	140	90	315	450	965/-	1891/2027	-/-	10-C st	10	82	82s
	4	200	322	16	125	100	8x19	8x19	140	90	315	450	965/-	2046/2182	-/-	10-C st	10	82	82s
		15	279	16	125	100	8x19	8x19	140	90	315	350	554/651	1299/1435	1239/1375	7-B st	7	28	28s
		18.5	295	16	125	100	8x19	8x19	140	90	315	350	636/658	1282/1418	1265/1401	7-B st	7	35	35s
		22	312	16	125	100	8x19	8x19	140	90	315	350	636/-	1312/1448	-/-	7-B st	7	35	35s
		30	334	16	125	100	8x19	8x19	140	90	315	355	670/-	1360/1496	-/-	8 st	8	42	42s
		4	272	16	125	100	8x19	8x19	140	90	315	350	552/-	1079/1215	-/-	7 st	7	22	22s
	6	5.5	301	16	125	100	8x19	8x19	140	90	315	350	552/-	1129/1265	-/-	7 st	7	22	22s
		7.5	326	16	125	100	8x19	8x19	140	90	315	350	587/-	1218/1354	-/-	7-B st	7	28	28s
		11	334	16	125	100	8x19	8x19	140	90	315	350	587/-	1278/1414	-/-	7-B st	7	28	28s
22		334	16	125	100	8x19	8x19	140	110	355	380	669/-	1372/1508	-/-	9 st	9	36	36s	
30		360	16	125	100	8x19	8x19	140	110	355	380	695/-	1420/1556	-/-	9 st	9	43	43s	
37		375	16	125	100	8x19	8x19	140	110	355	380	718/-	1462/1598	-/-	9-B st	9	53	53s	
100-400	4	45	395	16	125	100	8x19	8x19	140	110	355	380	718/-	1522/1658	-/-	9-B st	9	53	53s
		55	415	16	125	100	8x19	8x19	140	110	355	380	790/-	1561/1697	-/-	9-B st	9	61	61s
		7.5	340	16	125	100	8x19	8x19	140	110	355	380	617/-	1278/1414	-/-	9 st	9	29	29s
	6	11	380	16	125	100	8x19	8x19	140	110	355	380	617/-	1338/1474	-/-	9 st	9	29	29s
		15	415	16	125	100	8x19	8x19	140	110	355	380	669/-	1372/1508	-/-	9 st	9	36	36s
		45	176-154	16	150	125	8x23	8x19	140	90	315	350	688/-	1432/1568	-/-	8-B st	8	52	52s
	2	55	196-166	16	150	125	8x23	8x19	140	90	315	355	765/-	1501/1637	-/-	9-C st	9	60	60s
		75	205	16	150	125	8x23	8x19	140	90	315	415	848/-	1574/1710	-/-	10-C st	10	73	73s
		90	219	16	150	125	8x23	8x19	140	90	315	415	848/-	1684/1820	-/-	10-C st	10	69	69s
		110	224	16	150	125	8x23	8x19	140	90	315	450	965/-	1666/1802	-/-	10-C st	10	76	76s
		5.5	176-154	16	150	125	8x23	8x19	140	90	315	350	509/587	1073/1209	994/1130	7 st	7	22	22s
		7.5	196-180	16	150	125	8x23	8x19	140	90	315	350	509/587	1123/1259	994/1130	7 st	7	22	22s
4	11	219	16	150	125	8x23	8x19	140	90	315	350	554/651	1269/1405	1195/1331	7-B st	7	28	28s	
	15	226	16	150	125	8x23	8x19	140	90	315	350	554/651	1299/1435	1239/1375	7-B st	7	28	28s	
	1.5	176-150	16	150	125	8x23	8x19	140	90	315	350	516/-	1010/1146	-/-	7 st	7	12	12s	
	2.2	196-182	16	150	125	8x23	8x19	140	90	315	350	527/-	1028/1164	-/-	7 st	7	17	17s	
	3	215	16	150	125	8x23	8x19	140	90	315	350	552/-	1079/1215	-/-	7 st	7	22	22s	
	4	226	16	150	125	8x23	8x19	140	90	315	350	552/-	1079/1215	-/-	7 st	7	22	22s	
6	90	222	16	150	125	8x23	8x19	140	90	355	415	848/-	1744/1880	-/-	10-C st	10	69	69s	
	110	236	16	150	125	8x23	8x19	140	90	355	450	965/-	1726/1862	-/-	10-C st	10	76	76s	
	132	249	16	150	125	8x23	8x19	140	90	355	450	965/-	1891/2027	-/-	10-C st	10	76	76s	
	160	263	16	150	125	8x23	8x19	140	90	355	450	965/-	1891/2027	-/-	10-C st	10	82	82s	
	200	269	16	150	125	8x23	8x19	140	90	355	450	965/-	2046/2182	-/-	10-C st	10	82	82s	
	11	220	16	150	125	8x23	8x19	140	90	355	350	554/651	1269/1405	1195/1331	7-B st	7	28	28s	
4	15	236	16	150	125	8x23	8x19	140	90	355	350	554/651	1299/1435	1239/1375	7-B st	7	28	28s	
	18.5	249	16	150	125	8x23	8x19	140	90	355	350	636/658	1282/1418	1265/1401	7-B st	7	35	35s	
	22	262	16	150	125	8x23	8x19	140	90	355	350	636/-	1312/1448	-/-	7-B st	7	35	35s	
	30	269	16	150	125	8x23	8x19	140	90	355	355	670/-	1360/1496	-/-	8 st	8	42	42s	
	3	216	16	150	125	8x23	8x19	140	90	355	350	552/-	1079/1215	-/-	7 st	7	22	22s	
	4	232	16	150	125	8x23	8x19	140	90	355	350	552/-	1079/1215	-/-	7 st	7	22	22s	
6	5.5	253	16	150	125	8x23	8x19	140	90	355	350	552/-	1129/1265	-/-	7 st	7	22	22s	
	7.5	269	16	150	125	8x23	8x19	140	90	355	350	587/-	1218/1354	-/-	7-B st	7	28	28s	
	132	262	16	150	125	8x23	8x19	140	110	355	450	965/-	1891/2027	-/-	10-C st	10	75	75s	
	160	277	16	150	125	8x23	8x19	140	110	355	450	965/-	1891/2027	-/-	10-C st	10	81	81s	
	200	297	16	150	125	8x23	8x19	140	110	355	450	965/-	2046/2182	-/-	10-C st	10	81	81s	
	250	317	16	150	125	8x23	8x19	140	110	355	450	950/-	2046/2182	-/-	10-C st	10	96	96s	
2	18.5	275	16	150	125	8x23	8x19	140	110	355	380	669/691	1342/1478	1325/1461	9 st	9	36	36s	
	22	290	16	150	125	8x23	8x19	140	110	355	380	669/-	1372/1508	-/-	9 st	9	36	36s	
	30	317	16	150	125	8x23	8x19	140	110	355	380	695/-	1420/1556	-/-	9 st	9	43	43s	
	37	336	16	150	125	8x23	8x19	140	110	355	380	718/-	1462/1598	-/-	9-B st	9	53	53s	
	45	338	16	150	125	8x23	8x19	140	110	355	380	718/-	1522/1658	-/-	9-B st	9	53	53s	
	5.5	275	16	150	125	8x23	8x19	140	110	355	385	587/-	1189/1325	-/-	9 st	9	23	23s	
4	7.5	297	16	150	125	8x23	8x19	140	110	355	380	617/-	1278/1414	-/-	9 st	9	29	29s	
	11	335	16	150	125	8x23	8x19	140	110	355	380	617/-	1338/1474	-/-	9 st	9	29	29s	
	15	338	16	150	125	8x23	8x19	140	110	355	380	669/-	1372/1508	-/-	9 st	9	36	36s	

1 Pump with standard coupling or pump with spacer coupling.

2 Pump with standard motor or pump with E-motor.

3 EN/ISO base frame, see page 153. C-channel base frame, see page 154.

Pump size	Poles	P2 [kW]	Actual impeller size	Flanges				NK dimensions [mm]					Base frame No ³⁾							
				PN	DNs	DNd	Ss	Sd	a	a2	h2	h3	h4 ²⁾	L ¹⁾		EN/ISO		C- channel		
														NK	NKE	Standard coupling	Spacer coupling	Standard coupling	Spacer coupling	
125-400	4	37	345	16	150	125	8x23	8x19	140	110	400	415	753/-	1462/1598	-/-	9-B st	9	54	54s	
		45	368	16	150	125	8x23	8x19	140	110	400	415	753/-	1522/1658	-/-	9-B st	9	54	54s	
		55	392	16	150	125	8x23	8x19	140	110	400	415	825/-	1561/1697	-/-	9-B st	9	62	62s	
		75	433	16	150	125	8x23	8x19	140	110	400	445	878/-	1634/1770	-/-	10-A st	10	67	67s	
	6	90	438	16	150	125	8x23	8x19	140	110	400	445	878/-	1744/1880	-/-	10-A st	10	67	67s	
		11	351	16	150	125	8x23	8x19	140	110	400	415	652/-	1338/1474	-/-	9 st	9	30	30s	
		15	384	16	150	125	8x23	8x19	140	110	400	415	701/-	1372/1508	-/-	9 st	9	37	37s	
		18.5	410	16	150	125	8x23	8x19	140	110	400	415	730/-	1395/1531	-/-	9 st	9	44	44s	
		22	434	16	150	125	8x23	8x19	140	110	400	415	730/-	1420/1556	-/-	9 st	9	44	44s	
		30	438	16	150	125	8x23	8x19	140	110	400	415	753/-	1522/1658	-/-	9-B st	9	54	54s	
		55	406	16	150	125	8x23	8x19	180	110	500	530	940/-	1741/1917	-/-	10-B st	10	57	57s	
		75	447	16	150	125	8x23	8x19	180	110	500	530	963/-	1814/1990	-/-	10-A st	10	65	65s	
125-500	4	90	473	16	150	125	8x23	8x19	180	110	500	530	963/-	1924/2100	-/-	10-A st	10	65	65s	
		110	500	16	150	125	8x23	8x19	180	110	500	530	1045/-	1936/2112	-/-	10-A st	10	79	79s	
		132	526	16	150	125	8x23	8x19	180	110	500	530	1045/-	2101/2277	-/-	10-A st	10	84	84s	
		160	548	16	150	125	8x23	8x19	180	110	500	530	1045/-	2101/2277	-/-	10-A st	10	84	84s	
	6	18.5	421	16	150	125	8x23	8x19	180	110	500	530	845/-	1575/1751	-/-	10-B st	10	46	46s	
		22	445	16	150	125	8x23	8x19	180	110	500	530	845/-	1600/1776	-/-	10-B st	10	46	46s	
		30	493	16	150	125	8x23	8x19	180	110	500	530	868/-	1702/1878	-/-	10-B st	10	49	49s	
		37	524	16	150	125	8x23	8x19	180	110	500	530	940/-	1741/1917	-/-	10-B st	10	57	57s	
		45	546	16	150	125	8x23	8x19	180	110	500	530	963/-	1814/1990	-/-	10-A st	10	65	65s	
		55	548	16	150	125	8x23	8x19	180	110	500	530	963/-	1814/1990	-/-	10-A st	10	65	65s	
		75	216-176	10	200	150	8x23	8x23	160	110	400	415	848/-	1594/1730	-/-	10-C st	10	71	71s	
		90	218-202	10	200	150	8x23	8x23	160	110	400	415	848/-	1704/1840	-/-	10-C st	10	68	68s	
150-200	2	110	224	10	200	150	8x23	8x23	160	110	400	450	965/-	1686/1822	-/-	10-C st	10	75	75s	
		7.5	210-158	10	200	150	8x23	8x23	160	110	400	385	544/622	1143/1279	1014/1150	9 st	9	23	23s	
	4	11	218-208	10	200	150	8x23	8x23	160	110	400	380	584/681	1289/1425	1215/1351	9 st	9	29	29s	
		15	224	10	200	150	8x23	8x23	160	110	400	380	584/681	1319/1455	1259/1395	9 st	9	29	29s	
	6	2.2	210-168	10	200	150	8x23	8x23	160	110	400	380	557/-	1048/1184	-/-	9 st	9	18	18s	
		3	218-200	10	200	150	8x23	8x23	160	110	400	385	587/-	1099/1235	-/-	9 st	9	23	23s	
		4	224	10	200	150	8x23	8x23	160	110	400	385	587/-	1099/1235	-/-	9 st	9	23	23s	
		132	226-220	10	200	150	8x23	8x23	160	110	375	450	965/-	1911/2047	-/-	10-C st	10	75	75s	
	150-250	2	160	235	10	200	150	8x23	8x23	160	110	375	450	965/-	1911/2047	-/-	10-C st	10	81	81s
			200	250	10	200	150	8x23	8x23	160	110	375	450	965/-	2066/2202	-/-	10-C st	10	81	81s
			250	265	10	200	150	8x23	8x23	160	110	375	450	950/-	2066/2202	-/-	10-C st	10	96	96s
			15	226-214	10	200	150	8x23	8x23	160	110	375	380	584/681	1379/1515	1319/1455	9 st	9	29	29s
4		18.5	230	10	200	150	8x23	8x23	160	110	375	380	669/691	1362/1498	1345/1481	9 st	9	36	36s	
		22	242	10	200	150	8x23	8x23	160	110	375	380	669/-	1392/1528	-/-	9 st	9	36	36s	
		30	262	10	200	150	8x23	8x23	160	110	375	380	695/-	1440/1576	-/-	9 st	9	43	43s	
		37	275	10	200	150	8x23	8x23	160	110	375	380	718/-	1482/1618	-/-	9-B st	9	53	53s	
		45	282	10	200	150	8x23	8x23	160	110	375	380	718/-	1542/1678	-/-	9-B st	9	53	53s	
		5.5	235	10	200	150	8x23	8x23	160	110	375	385	587/-	1209/1345	-/-	9 st	9	23	23s	
		7.5	252	10	200	150	8x23	8x23	160	110	375	380	617/-	1298/1434	-/-	9 st	9	29	29s	
		11	282	10	200	150	8x23	8x23	160	110	375	380	617/-	1358/1494	-/-	9 st	9	29	29s	
150-315.2	2	160	244	10	200	150	8x23	8x23	160	110	400	450	970/-	2191/2367	-/-	10-C st	10	81	81s	
		200	262	10	200	150	8x23	8x23	160	110	400	450	970/-	2206/2382	-/-	10-C st	10	81	81s	
		22	250	10	200	150	8x23	8x23	160	110	400	380	669/-	1392/1528	-/-	9 st	9	36	36s	
		30	275	10	200	150	8x23	8x23	160	110	400	380	698/-	1440/1576	-/-	9 st	9	43	43s	
	4	37	294	10	200	150	8x23	8x23	160	110	400	380	718/-	1482/1618	-/-	9-B st	9	53	53s	
		45	314	10	200	150	8x23	8x23	160	110	400	380	718/-	1542/1678	-/-	9-B st	9	53	53s	
		55	334	10	200	150	8x23	8x23	160	110	400	380	790/-	1581/1717	-/-	9-B st	9	61	61s	
		75	342	10	200	150	8x23	8x23	160	110	400	415	848/-	1654/1790	-/-	10-A st	10	68	68s	
		7.5	259	10	200	150	8x23	8x23	160	110	400	380	617/-	1298/1434	-/-	9 st	9	29	29s	
		11	293	10	200	150	8x23	8x23	160	110	400	380	617/-	1358/1494	-/-	9 st	9	29	29s	
		15	328	10	200	150	8x23	8x23	160	110	400	380	669/-	1392/1528	-/-	9 st	9	36	36s	
		18.5	342	10	200	150	8x23	8x23	160	110	400	380	695/-	1415/1551	-/-	9 st	9	43	43s	
150-315	4	37	275	10	200	150	8x23	8x23	160	110	400	380	718/-	1482/1618	-/-	9-B st	9	53	53s	
		45	291	10	200	150	8x23	8x23	160	110	400	380	718/-	1542/1678	-/-	9-B st	9	53	53s	
		55	310	10	200	150	8x23	8x23	160	110	400	380	790/-	1581/1717	-/-	9-B st	9	61	61s	
		75	336	10	200	150	8x23	8x23	160	110	400	415	848/-	1654/1790	-/-	10-A st	10	68	68s	
	6	90	338	10	200	150	8x23	8x23	160	110	400	415	848/-	1764/1900	-/-	10-A st	10	68	68s	
		11	280	10	200	150	8x23	8x23	160	110	400	380	617/-	1358/1494	-/-	9 st	9	29	29s	
		15	305	10	200	150	8x23	8x23	160	110	400	380	669/-	1392/1528	-/-	9 st	9	36	36s	
		18.5	322	10	200	150	8x23	8x23	160	110	400	380	695/-	1415/1551	-/-	9 st	9	43	43s	
		22	337	10	200	150	8x23	8x23	160	110	400	380	695/-	1440/1576	-/-	9 st	9	43	43s	
		30	338	10	200	150	8x23	8x23	160	110	400	380	718/-	1542/1678	-/-	9-B st	9	53	53s	

1 Pump with standard coupling or pump with spacer coupling.
 2 Pump with standard motor or pump with E-motor.
 3 EN/ISO base frame, see page 153. C-channel base frame, see page 154.

Pump size	Poles	P2 [kW]	Actual impeller size	Flanges					NK dimensions [mm]						Base frame No ³⁾				
				PN	DNs	DNd	Ss	Sd	a	a2	h2	h3	h4 ²⁾	L ¹⁾		EN/ISO		C- channel	
														NK	NKE	Standard coupling	Spacer coupling	Standard coupling	Spacer coupling
150-400	4	55	343	10	200	150	8x23	8x23	160	110	450	415	825/-	1581/1717	-/-	9-B st	9	62	62s
		75	375	10	200	150	8x23	8x23	160	110	450	445	878/-	1654/1790	-/-	10-A st	10	67	67s
		90	394	10	200	150	8x23	8x23	160	110	450	445	878/-	1764/1900	-/-	10-A st	10	67	67s
		110	412	10	200	150	8x23	8x23	160	110	450	450	965/-	1776/1912	-/-	10-A st	10	74	74s
		132	431	10	200	150	8x23	8x23	160	110	450	450	965/-	1542/2257	-/-	10-A st	10	85	85s
	6	160	438	10	200	150	8x23	8x23	160	110	450	450	965/-	2081/2257	-/-	10-A st	10	85	85s
		18.5	357	10	200	150	8x23	8x23	160	110	450	415	730/-	1415/1551	-/-	9 st	9	44	44s
		22	375	10	200	150	8x23	8x23	160	110	450	415	730/-	1440/1576	-/-	9 st	9	44	44s
		30	408	10	200	150	8x23	8x23	160	110	450	415	753/-	1542/1678	-/-	9-B st	9	54	54s
		37	430	10	200	150	8x23	8x23	160	110	450	415	825/-	1581/1717	-/-	9-B st	9	62	62s
150-500	4	45	438	10	200	150	8x23	8x23	160	110	450	445	878/-	1654/1790	-/-	10-A st	10	67	67s
		132	459	10	200	150	8x23	8x23	180	110	500	530	1045/-	2101/2277	-/-	10-A st	10	84	84s
		160	489	10	200	150	8x23	8x23	180	110	500	530	1045/-	2101/2277	-/-	10-A st	10	84	84s
		200	521	10	200	150	8x23	8x23	180	110	500	530	1045/-	2256/2432	-/-	10-A st	10	84	84s
		37	457	10	200	150	8x23	8x23	180	110	500	530	940/-	1741/1917	-/-	10-B st	10	57	57s
	6	45	483	10	200	150	8x23	8x23	180	110	500	530	963/-	1814/1990	-/-	10-A st	10	65	65s
		55	513	10	200	150	8x23	8x23	180	110	500	530	963/-	1814/1990	-/-	10-A st	10	65	65s
		75	548	10	200	150	8x23	8x23	180	110	500	530	1045/-	1936/2112	-/-	10-A st	10	79	79s
		37	280	10	250	200	12x23	8x23	170	110	400	530	868/-	1660/1836	-/-	10E	10F	49	49s
		45	296	10	250	200	12x23	8x23	170	110	400	530	868/-	1720/1896	-/-	10E	10F	49	49s
200-400	4	55	312	10	250	200	12x23	8x23	170	110	400	530	940/-	1759/1935	-/-	10E	10F	57	57s
		75	344	10	250	200	12x23	8x23	170	110	400	530	963/-	1832/2008	-/-	10E	10D	65	65s
		90	364	10	250	200	12x23	8x23	170	110	400	530	963/-	1942/2118	-/-	10F	10D	65	65s
		110	392	10	250	200	12x23	8x23	170	110	400	530	1050/-	1954/2130	-/-	10F	10D	79	79s
		132	404	10	250	200	12x23	8x23	170	110	400	530	1050/-	2119/2295	-/-	10D	10D	84	84s
	6	15	308	10	250	200	12x23	8x23	170	110	400	530	816/-	1570/1746	-/-	10E	10E	39	39s
		18.5	328	10	250	200	12x23	8x23	170	110	400	530	845/-	1593/1769	-/-	10E	10F	46	46s
		22	348	10	250	200	12x23	8x23	170	110	400	530	845/-	1618/1794	-/-	10E	10F	46	46s
		30	384	10	250	200	12x23	8x23	170	110	400	530	868/-	1720/1896	-/-	10E	10F	49	49s
		37	404	10	250	200	12x23	8x23	170	110	400	530	940/-	1759/1935	-/-	10E	10F	57	57s
200-450	4	75	367	10	250	200	12x23	8x23	150	110	450	530	963/-	1805/1981	-/-	10E	10D	65	65s
		90	391	10	250	200	12x23	8x23	150	110	450	530	963/-	1915/2091	-/-	10F	10D	65	65s
		110	415	10	250	200	12x23	8x23	150	110	450	530	1050/-	1927/2103	-/-	10F	10D	79	79s
		132	435	10	250	200	12x23	8x23	150	110	450	530	1050/-	2092/2268	-/-	10D	10D	84	84s
		160	455	10	250	200	12x23	8x23	150	110	450	530	1050/-	2092/2268	-/-	10D	10D	84	84s
	6	18.5	355	10	250	200	12x23	8x23	150	110	450	530	845/-	1566/1742	-/-	10E	10F	46	46s
		22	371	10	250	200	12x23	8x23	150	110	450	530	845/-	1591/1767	-/-	10E	10F	46	46s
		30	407	10	250	200	12x23	8x23	150	110	450	530	868/-	1693/1869	-/-	10E	10F	49	49s
		37	431	10	250	200	12x23	8x23	150	110	450	530	940/-	1732/1908	-/-	10E	10F	57	57s
		45	451	10	250	200	12x23	8x23	150	110	450	530	963/-	1805/1981	-/-	10E	10D	65	65s
250-350	4	37	266	10	300	250	12x23	12x23	180	110	400	580	918/-	1711/1887	-/-	10E	10F	50	50s
		45	294	10	300	250	12x23	12x23	180	110	400	580	918/-	1771/1947	-/-	10E	10F	50	50s
		55	318	10	300	250	12x23	12x23	180	110	400	580	990/-	1810/1986	-/-	10E	10F	58	58s
		75	362	10	300	250	12x23	12x23	180	110	400	580	1013/-	1883/2059	-/-	10F	10D	66	66s
		90	370	10	300	250	12x23	12x23	180	110	400	580	1013/-	1993/2169	-/-	10F	10D	66	66s
	6	11	277	10	300	250	12x23	12x23	180	110	400	580	817/-	1587/1763	-/-	10E	10E	26	26s
		15	306	10	300	250	12x23	12x23	180	110	400	580	866/-	1621/1797	-/-	10E	10E	40	40s
		18.5	330	10	300	250	12x23	12x23	180	110	400	580	895/-	1644/1820	-/-	10E	10F	47	47s
		22	366	10	300	250	12x23	12x23	180	110	400	580	895/-	1669/1845	-/-	10E	10F	47	47s
		45	281	10	300	250	12x23	12x23	160	110	500	580	918/-	1726/1902	-/-	10E	10F	50	50s
250-400	4	55	301	10	300	250	12x23	12x23	160	110	500	580	990/-	1765/1941	-/-	10E	10F	58	58s
		75	329	10	300	250	12x23	12x23	160	110	500	580	1013/-	1838/2014	-/-	10F	10D	66	66s
		90	349	10	300	250	12x23	12x23	160	110	500	580	1013/-	1948/2124	-/-	10F	10D	66	66s
		110	365	10	300	250	12x23	12x23	160	110	500	580	1100/-	1960/2136	-/-	10F	10D	78	78s
		132	385	10	300	250	12x23	12x23	160	110	500	580	1100/-	2125/2301	-/-	10F	10D	83	83s
	6	160	405	10	300	250	12x23	12x23	160	110	500	580	1100/-	2125/2301	-/-	10F	10D	83	83s
		15	289	10	300	250	12x23	12x23	160	110	500	580	866/-	1576/1752	-/-	10E	10E	40	40s
		18.5	313	10	300	250	12x23	12x23	160	110	500	580	895/-	1599/1775	-/-	10E	10F	47	47s
		22	329	10	300	250	12x23	12x23	160	110	500	580	895/-	1624/1800	-/-	10E	10F	47	47s
		30	361	10	300	250	12x23	12x23	160	110	500	580	918/-	1726/1902	-/-	10E	10F	50	50s
37	381	10	300	250	12x23	12x23	160	110	500	580	990/-	1765/1941	-/-	10E	10F	58	58s		
45	401	10	300	250	12x23	12x23	160	110	500	580	1013/-	1838/2014	-/-	10F	10D	66	66s		

¹ Pump with standard coupling or pump with spacer coupling.

² Pump with standard motor or pump with E-motor.

³ EN/ISO base frame, see page 153. C-channel base frame, see page 154.

Pump size	Poles	P2 [kW]	Actual impeller size	Flanges				NK dimensions [mm]						Base frame No ³⁾					
				PN	DNs	DNd	Ss	Sd	a	a2	h2	h3	h4 ²⁾	L ¹⁾		EN/ISO		C- channel	
														NK	NKE	Standard coupling	Spacer coupling	Standard coupling	Spacer coupling
250-450	4	75	325	10	300	250	12x23	12x23	165	110	500	580	1013/-	1833/2009	-/-	10F	10D	66	66s
		90	341	10	300	250	12x23	12x23	165	110	500	580	1013/-	1943/2119	-/-	10F	10D	66	66s
		110	361	10	300	250	12x23	12x23	165	110	500	580	1100/-	1955/2131	-/-	10F	10D	78	78s
		132	381	10	300	250	12x23	12x23	165	110	500	580	1100/-	2120/2296	-/-	10F	10D	83	83s
		160	401	10	300	250	12x23	12x23	165	110	500	580	1100/-	2120/2296	-/-	10F	10D	83	83s
	6	200	445	10	300	250	12x23	12x23	165	110	500	580	1100/-	2275/2451	-/-	10F	10D	83	83s
		18.5	313	10	300	250	12x23	12x23	165	110	500	580	895/-	1594/1770	-/-	10E	10F	47	47s
		22	325	10	300	250	12x23	12x23	165	110	500	580	895/-	1619/1795	-/-	10E	10F	47	47s
		30	357	10	300	250	12x23	12x23	165	110	500	580	918/-	1721/1897	-/-	10E	10F	50	50s
		37	377	10	300	250	12x23	12x23	165	110	500	580	990/-	1760/1936	-/-	10E	10F	58	58s
250-500	4	45	397	10	300	250	12x23	12x23	165	110	500	580	1013/-	1833/2009	-/-	10F	10D	66	66s
		55	433	10	300	250	12x23	12x23	165	110	500	580	1013/-	1723/1899	-/-	10F	10D	66	66s
		160	417	10	300	250	12x23	12x23	165	110	500	580	1100/-	2125/2301	-/-	10F	10D	83	83s
		200	445	10	300	250	12x23	12x23	165	110	500	580	1100/-	2280/2456	-/-	10F	10D	83	83s
		250	485	10	300	250	12x23	12x23	165	110	500	580	1080/-	2280/2456	-/-	10D	10G	98	98s
	6	315	525	10	300	250	12x23	12x23	165	110	500	580	1080/-	-/2600	-/-	-	10G	-	98s
		45	409	10	300	250	12x23	12x23	165	110	500	580	1013/-	1838/2014	-/-	10E	10D	66	66s
		55	437	10	300	250	12x23	12x23	165	110	500	580	1013/-	1728/1904	-/-	10F	10D	66	66s
		75	485	10	300	250	12x23	12x23	165	110	500	580	1100/-	1960/2136	-/-	10F	10D	78	78s
		90	525	10	300	250	12x23	12x23	165	110	500	580	1100/-	2125/2301	-/-	10F	10D	83	83s

1 Pump with standard coupling or pump with spacer coupling.
 2 Pump with standard motor or pump with E-motor.
 3 EN/ISO base frame, see page 153. C-channel base frame, see page 154.

Dimensional drawing, NBE, NKE Series 2000

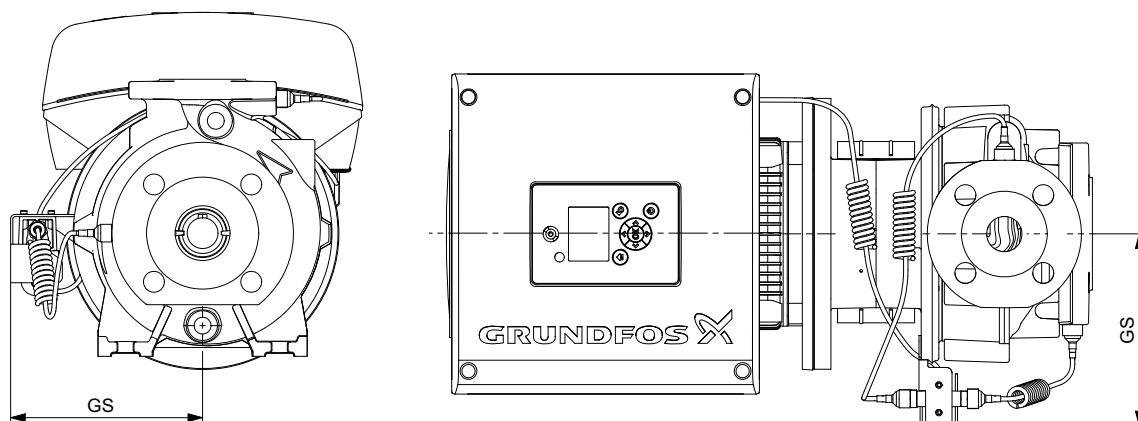

TM07 2906 4418

Technical data, NBE, NKE Series 2000

Pump size	GS [mm]
32-125	180
32-125.1	180
32-160	180
32-160.1	180
32-200	200
32-200.1	200
32-250	230
40-125	180
40-160	180
40-200	200
40-250	230
40-315	265
50-125	180
50-160	180
50-200	200
50-250	230
50-315	265
65-125	180
65-160	180
65-200	200
65-250	245
65-315	272
80-160	180
80-200	202
80-250	245
100-160	180
100-200	202
125-200	200
150-200	275

18. Minimum efficiency index

Minimum efficiency index (MEI) means the dimensionless scale unit for hydraulic pump efficiency at best efficiency point (BEP), part load (PL) and overload (OL). The Commission Regulation (EU) sets efficiency requirements to MEI greater than or equal to 0.10 as from 1 January 2013 and MEI greater than or equal to 0.40 as from 1 January 2015. An indicative benchmark for best-performing water pump available on the market as from 1 January 2013 is determined in the Regulation.

- The benchmark for most efficient water pumps is MEI greater than or equal to 0.70.
- The efficiency of a pump with a trimmed impeller is usually lower than that of a pump with the full impeller diameter. The trimming of the impeller will adapt the pump to a fixed duty point, leading to reduced energy consumption. The minimum efficiency index (MEI) is based on the full impeller diameter.
- The operation of this water pump with variable duty points may be more efficient and economic when controlled, for example by using a variable-speed drive that matches the pump duty to the system.

Information on benchmark efficiency is available at <http://europump.eu/efficiencycharts>.

2-pole			4-pole			6-pole		
Pump size	NB MEI	NK MEI	Pump size	NB MEI	NK MEI	Pump size	NB MEI	NK MEI
32-125.1/140	0.70	0.70	32-125.1/140	0.70	0.70	100-160/176	0.70	0.70
32-125/142	0.70	0.70	32-125/142	0.70	0.70	100-200/219	0.70	0.65
32-160.1/177	0.70	0.70	32-160.1/177	0.60	0.55	100-250/274	0.70	0.70
32-160/177	0.59	0.52	32-160/173	0.65	0.60	100-315/334	0.70	0.70
32-200.1/207	0.58	0.52	32-200.1/207	0.70	0.70	100-400/415	0.70	0.70
32-200/219	0.62	0.55	32-200/219	0.69	0.64	125-200/226	0.70	0.70
32-250/262	0.70	0.65	32-250/262	0.70	0.70	125-250/269	0.70	0.68
40-125/142	0.70	0.70	40-125/142	0.70	0.70	125-315/338	0.70	0.70
40-160/177	0.70	0.70	40-160/177	0.70	0.70	125-400/438	0.56	0.51
40-200/219	0.65	0.59	40-200/219	0.70	0.70	125-500/548	0.50	0.46
40-250/260	0.70	0.70	40-250/260	0.70	0.70	150-200/224	0.70	0.70
40-315/336	0.70	0.70	40-315/344	0.64	0.60	150-250/282	0.70	0.67
50-125/144	0.70	0.68	50-125/144	0.64	0.60	150-315.2/342	0.70	0.65
50-160/177	0.70	0.70	50-160/177	0.70	0.70	150-315/338	0.60	0.54
50-200/219	0.70	0.70	50-200/219	0.70	0.70	150-400/438	0.70	0.70
50-250/263	0.67	0.61	50-250/263	0.70	0.70	150-500/548	0.66	0.61
50-315/321	0.56	0.50	50-315/344	0.70	0.70	200-400/404	0.70	0.69
65-125/144	0.70	0.70	65-125/144	0.70	0.70	200-450/451	0.45	0.42
65-160/177	0.70	0.70	65-160/177	0.70	0.70	250-350/366	0.70	0.70
65-200/219	0.70	0.70	65-200/219	0.70	0.70	250-400/401	0.46	0.42
65-250/270	0.57	0.51	65-250/270	0.70	0.67	250-450/433	0.69	0.64
65-315/320	0.70	0.65	65-315/320	0.70	0.70	250-500/525	0.48	0.45
80-160/177	0.70	0.70	80-160/177	0.70	0.70			
80-200/222	0.70	0.65	80-200/222	0.70	0.70			
80-250/270	0.70	0.70	80-250/270	0.70	0.70			
80-315/328	0.68	0.62	80-315/334	0.70	0.70			
100-160/176	0.70	0.70	80-400/438	0.44	0.41			
100-200/219	0.68	0.62	100-160/176	0.70	0.70			
100-250/274	0.70	0.70	100-200/219	0.65	0.61			
100-315/322	0.63	0.56	100-250/274	0.70	0.70			
125-200/224	0.70	0.70	100-315/334	0.70	0.70			
125-250/269	0.55	0.49	100-400/415	0.70	0.70			
125-315/317	0.69	0.62	125-200/226	0.70	0.70			
150-200/224	0.70	0.70	125-250/269	0.62	0.57			
150-250/265	0.70	0.70	125-315/338	0.68	0.63			
150-315.2/262	0.70	0.70	125-400/438	0.55	0.50			
			125-500/548	0.50	0.46			
			150-200/224	0.70	0.70			
			150-250/282	0.67	0.62			
			150-315.2/342	0.68	0.63			
			150-315/338	0.53	0.48			
			150-400/438	0.70	0.70			
			150-500/521	0.47	0.43			
			200-400/404	0.58	0.52			
			200-450/455	0.44	0.40			
			250-350/370	0.70	0.70			
			250-400/405	0.50	0.46			
			250-450/445	0.70	0.68			
			250-500/525	0.48	0.45			

19. Base frames

NK base frames

The EN/ISO base frame number is stated for each pump mentioned in section [17. Dimensional drawings and technical data](#).

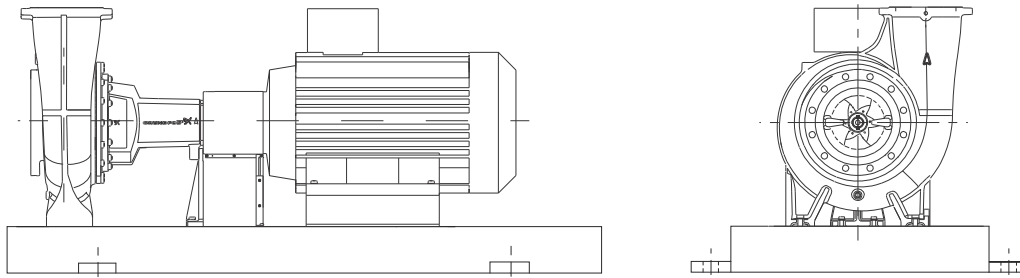

Fig. 78 NK pump with EN/ISO base frame

The C-channel base frame number is stated for each pump mentioned in section [NK with C-channel base frames, dimensional sketches](#). See page [154](#).

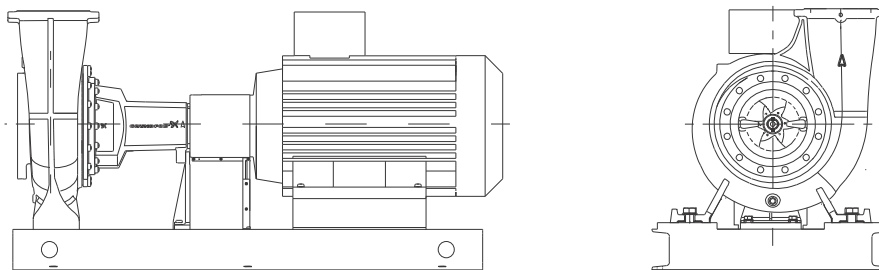

Fig. 79 NK pump with C-channel base frame

TM05 1513 2417

TM05 9293 2417

NK with EN/ISO base frames, dimensional sketches

The EN/ISO base frame number is stated for each pump mentioned in section 17. *Dimensional drawings and technical data.*

EN/ISO base frame with 4 mounting holes

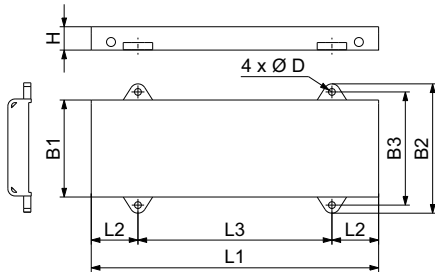

TM07 0506 5117

Fig. 80 EN/ISO base frame with 4 mounting holes

Base frame number	Dimensions [mm]							
	L1	L2	L3	B1	B2	B3	D	H
2	800	130	540	270	360	315	19	65
2 st	704	130	444	270	360	315	19	65
3	900	150	600	300	390	345	19	65
3 st	804	150	504	300	390	345	19	65
3-B st	804	150	504	300	390	345	19	65
4	1000	170	660	340	450	400	24	80
4-B st	929	170	589	340	450	400	24	80
5	1120	190	740	380	490	440	24	80
5 st	1022	190	642	380	490	440	24	80
5-B st	1022	190	642	380	490	440	24	80
6	1250	205	840	430	540	490	24	80
6 st	1143	205	733	430	540	490	24	80
6-B st	1175	205	765	430	540	490	24	80
7	1400	230	940	480	610	560	28	100
7 st	1101	230	641	480	610	560	28	100
7-B st	1294	230	834	480	610	560	28	100

EN/ISO base frame with 6 mounting holes

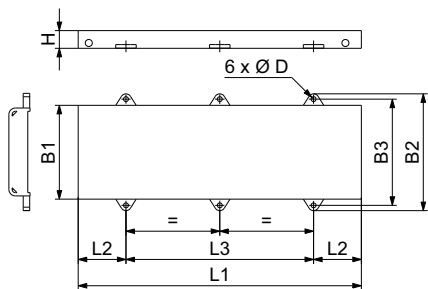

TM07 0504 5117

Fig. 81 EN/ISO base frame with 6 mounting holes

Base frame number	Dimensions [mm]							
	L1	L2	L3	B1	B2	B3	D	H
8	1600	270	1060	530	660	600	28	100
8 st	1464	270	924	530	660	600	28	100
8-B st	1464	270	924	530	660	600	28	100
9	1800	300	1200	600	730	670	28	100
9 st	1624	300	1024	600	730	670	28	100
9-B st	1624	300	1024	600	730	670	28	100
9-C st	1634	300	1024	600	730	670	28	100
10	2000	330	1340	730	890	830	28	130
10-A st	1824	330	1164	730	890	830	28	130
10-B st	1824	330	1164	730	890	830	28	130
10-C st	1824	330	1164	730	890	830	28	130

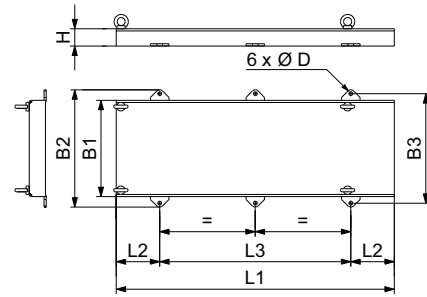

TM07 0505 5117

Fig. 82 EN/ISO base frame with lifting eyes and 6 mounting holes

Base frame number	Dimensions [mm]							
	L1	L2	L3	B1	B2	B3	D	H
10D	2110	330	1450	730	890	830	28	130
10E	1690	330	1030	730	890	830	28	130
10F	1880	330	1220	730	890	830	28	130
10G	2290	330	1630	730	890	830	28	130

EN/ISO base frame with 8 mounting holes

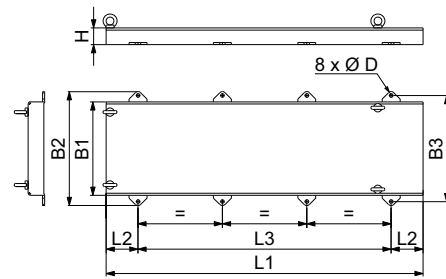

TM07 0507 5117

Fig. 83 EN/ISO base frame with 8 mounting holes

Base frame number	Dimensions [mm]							
	L1	L2	L3	B1	B2	B3	D	H
10H	2480	250	1980	730	890	830	28	130

NK with C-channel base frames, dimensional sketches

C-channel base frame with 4 mounting holes

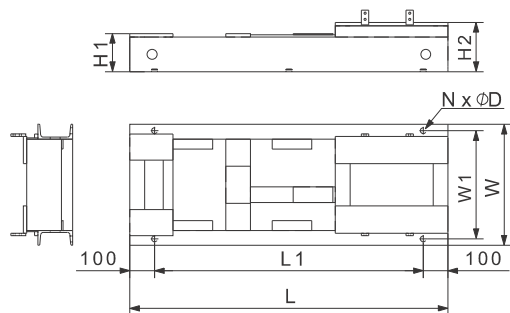

TM05 7709 1513

Fig. 84 C-channel base frame with 4 mounting holes

Base frame number	Dimensions [mm]							
	L	L1	W	W1	H1	H2	N	D
1	645	445	330	295	73	134	4	14
1s	731	531	330	295	73	134	4	14
2	700	500	300	265	73	105	4	14
2s	796	596	300	265	73	105	4	14
3	685	485	400	365	77	177	4	14
3s	781	581	400	365	77	177	4	14
3As	800	600	400	365	77	197	4	14
4	805	605	400	365	77	177	4	14
4s	941	741	400	365	77	177	4	14
5	710	510	312	277	73	105	4	14
5s	806	606	312	277	73	105	4	14
6	730	530	400	365	77	167	4	14
6s	826	626	360	325	77	167	4	14
6As	850	650	400	365	77	167	4	14
7	840	640	400	365	77	167	4	14
7s	976	776	400	365	77	167	4	14
8	860	660	430	395	77	237	4	14
8s	996	796	430	395	77	237	4	14
9	750	550	346	303	110	142	4	19
9s	846	646	346	303	110	142	4	19
10	740	540	416	373	114	194	4	19
10s	876	676	416	373	114	194	4	19
11	900	700	416	373	114	194	4	19
12	920	720	446	403	114	239	4	19
13	910	710	596	553	116	296	4	19
14	765	565	346	303	114	134	4	19
14s	855	655	346	303	114	134	4	19
15	755	555	416	373	114	182	4	19
15s	885	685	416	373	114	182	4	19
16	900	700	446	403	114	182	4	19
17	930	730	456	413	114	227	4	19
18	920	720	596	553	116	284	4	19
19	850	650	341	298	114	114	4	19
19s	940	740	341	298	114	114	4	19
20	850	650	416	373	114	162	4	19
20s	980	780	416	373	114	162	4	19
21	980	780	447	404	114	162	4	19
31	970	770	386	343	138	110	4	19
32	990	790	416	373	114	134	4	19
110	860	660	400	365	77	187	4	14

C-channel base frame with 6 mounting holes

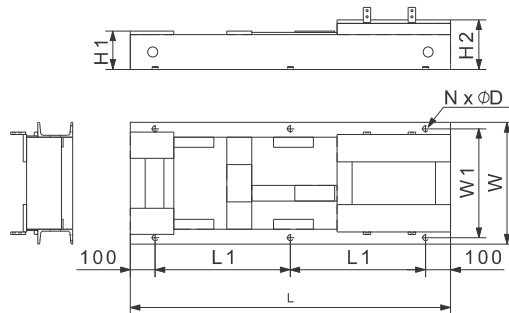

TM05 7710 1513

Fig. 85 C-channel base frame with 6 mounting holes

Base frame number	Dimensions [mm]							
	L	L1	W	W1	H1	H2	N	D
11s	1036	418	416	373	114	194	6	19
12s	1030	415	446	403	114	239	6	19
12As	1050	425	446	403	114	239	6	19
13s	1020	410	596	553	116	296	6	19
13As	1080	440	596	553	116	296	6	19
16s	1036	418	446	403	114	182	6	19
17s	1030	415	456	413	114	227	6	19
17As	1060	430	456	413	114	227	6	19
18s	1096	448	596	553	116	284	6	19
21s	1116	458	447	404	114	162	6	19
21As	1030	415	406	363	110	178	6	19
22	1010	405	446	403	114	207	6	19
22s	1080	440	446	403	114	207	6	19
22As	1150	475	446	403	114	207	6	19
23	1030	415	591	548	116	264	6	19
23s	1180	490	591	548	116	264	6	19
23As	1210	505	546	503	116	264	6	19
24	1300	550	586	543	116	271	6	19
24s	1476	638	586	543	116	271	6	19
25	1315	557.5	636	593	116	356	6	19
25s	1491	645.5	636	593	116	356	6	19
26	1350	575	636	593	116	406	6	19
26s	1526	663	636	593	116	406	6	19
27	1140	470	446	403	114	134	6	19
27s	1270	535	446	403	114	134	6	19
28	1140	470	446	403	114	179	6	19
28s	1250	525	446	403	114	179	6	19
28As	1280	540	446	403	114	179	6	19
29	1160	480	586	543	116	236	6	19
29s	1336	568	586	543	116	236	6	19
30	1156	478	596	553	116	271	6	19
30s	1292	546	596	553	116	271	6	19
31s	1053	426.5	386	343	138	110	6	19
32s	1100	450	416	373	114	134	6	19
33	1005	402.5	440	388	154	154	6	24
33s	1105	452.5	440	388	154	154	6	24
34	1150	475	470	418	154	154	6	24
34s	1286	543	470	418	154	154	6	24
35	1180	490	489	437	154	199	6	24
35s	1285	542.5	489	437	154	199	6	24
35As	1315	557.5	489	437	154	199	6	24
36	1200	500	610	558	160	260	6	24
36s	1370	585	610	558	160	260	6	24
37	1200	500	620	568	156	291	6	24
37s	1336	568	620	568	156	291	6	24
38	1340	570	620	568	156	291	6	24
38s	1516	658	620	568	156	291	6	24
39	1365	582.5	670	618	156	376	6	24
39s	1541	670.5	670	618	156	376	6	24
40	1403	601.5	660	610	156	426	6	24
40s	1579	689.5	660	610	156	426	6	24

Base frame number	Dimensions [mm]							
	L	L1	W	W1	H1	H2	N	D
41	1110	455	470	418	170	150	6	24
41s	1220	510	470	418	170	150	6	24
42	1216	508	500	448	154	179	6	24
42s	1352	576	500	448	154	179	6	24
42As	1350	575	500	448	154	179	6	24
43	1240	520	610	558	156	236	6	24
43s	1420	610	610	558	156	236	6	24
44	1240	520	610	558	156	271	6	24
44s	1376	588	610	558	156	271	6	24
45	1380	590	610	558	156	271	6	24
45s	1556	678	610	558	156	271	6	24
46	1400	600	660	608	156	356	6	24
46s	1576	688	660	608	156	356	6	24
47	1438	619	660	608	156	406	6	24
47s	1614	707	660	608	156	406	6	24
48	1438	619	610	558	156	246	6	24
48s	1614	707	610	558	156	246	6	24
49	1460	630	660	608	156	331	6	24
49s	1636	718	660	608	156	331	6	24
50	1504	652	660	608	156	381	6	24
50s	1680	740	660	608	156	381	6	24
51	1230	515	520	468	197	152	6	24
51s	1366	583	520	468	197	152	6	24
52	1300	550	510	458	154	154	6	24
52s	1436	618	510	458	154	154	6	24
53	1310	555	610	558	160	215	6	24
53s	1486	643	610	558	160	215	6	24
54	1305	552.5	610	558	160	250	6	24
54s	1440	620	610	558	160	250	6	24
55	1120	460	520	468	197	152	6	24
55s	1240	520	520	468	197	152	6	24
56	1500	650	630	569	196	261	6	28
56s	1676	738	630	569	196	261	6	28
57	1530	665	680	619	196	346	6	28
57s	1706	753	680	619	196	346	6	28
58	1568	684	780	719	196	396	6	28
58s	1744	772	780	719	196	396	6	28
59	1330	565	596	535	266	196	6	28
59s	1466	633	596	535	266	196	6	28
60	1370	585	596	535	219	194	6	28
60s	1506	653	596	535	219	194	6	28
61	1390	595	644	583	196	226	6	28
61s	1566	683	644	583	196	226	6	28
62	1370	585	630	569	196	261	6	28
62s	1506	653	630	569	196	261	6	28
63	1230	515	596	535	264	194	6	28
63s	1336	568	596	535	264	194	6	28
64	1660	730	680	619	196	231	6	28
64s	1836	818	680	619	196	231	6	28
65	1660	730	690	629	196	316	6	28
65s	1836	818	690	629	196	316	6	28
66	1700	750	780	719	196	366	6	28
66s	1876	838	780	719	196	366	6	28
67	1520	660	660	599	196	231	6	28
67s	1656	728	660	599	196	231	6	28
68	1520	660	637	576	196	196	6	28
68s	1660	730	637	576	196	196	6	28
69	1460	630	647	586	251	196	6	28
69s	1596	698	647	586	251	196	6	28
70	1420	610	647	586	296	196	6	28
70s	1556	678	647	586	296	196	6	28
71	1370	585	637	576	196	196	6	28
71s	1506	653	637	576	196	196	6	28
72	1390	595	647	586	296	196	6	28
72s	1526	663	647	586	296	196	6	28
73	1380	590	650	589	251	196	6	28
73s	1516	658	650	589	251	196	6	28
74	1540	637.5	698	637	196	196	6	28
74s	1676	705.5	698	637	196	196	6	28

Base frame number	Dimensions [mm]							
	L	L1	W	W1	H1	H2	N	D
75	1600	700	700	639	231	196	6	28
75s	1776	788	700	639	231	196	6	28
76	1600	700	702	641	288	198	6	28
76s	1736	768	702	641	288	198	6	28
77	1440	620	702	641	333	198	6	28
77s	1576	688	702	641	333	198	6	28
78	1710	755	780	719	196	331	6	28
78s	1886	843	780	719	196	331	6	28
79	1700	750	690	629	196	281	6	28
79s	1876	838	690	629	196	281	6	28
80	1750	775	690	629	196	196	6	28
80s	1926	863	690	629	196	196	6	28
81	1688	744	690	629	231	196	6	28
81s	1830	815	690	629	231	196	6	28
82	1580	690	690	629	265	200	6	28
82s	1716	758	690	629	265	200	6	28
83	1900	850	780	719	196	331	6	28
84	1850	825	690	629	196	281	6	28
85	1830	815	690	629	196	196	6	28
86	1820	810	710	649	231	196	6	28
86s	1996	898	710	649	231	196	6	28
87	1800	800	710	649	265	200	6	28
87s	1936	868	710	649	265	200	6	28
90	1980	890	710	649	196	196	6	28
96	1800	800	750	689	235	200	6	28
96s	1976	888	750	689	235	200	6	28
97	1675	737.5	750	689	265	200	6	28
97s	1810	805	750	689	265	200	6	28
98	1900	850	790	729	196	331	6	28
99	1880	840	750	689	196	281	6	28
100	1860	830	750	689	200	200	6	28
101	1800	800	800	739	275	200	6	28
101s	1976	888	800	739	275	200	6	28
102	1790	795	800	739	305	200	6	28
102s	1926	863	800	739	305	200	6	28
104	1980	890	800	739	196	241	6	28
110s	996	398	400	365	77	187	6	14
111	1225	512.5	480	428	172	152	6	24
111s	1360	580	480	428	172	152	6	24
112	1170	485	591	548	116	299	6	19
112s	1346	573	591	548	116	299	6	19
113	1890	845	800	739	275	200	6	28
114	1030	415	591	548	116	299	6	19
114s	1166	483	591	548	116	299	6	19
115	1768	784	690	629	231	196	6	28
115s	1944	872	690	629	231	196	6	28
116	1920	860	710	649	231	196	6	28

C-channel base frame with 8 mounting holes

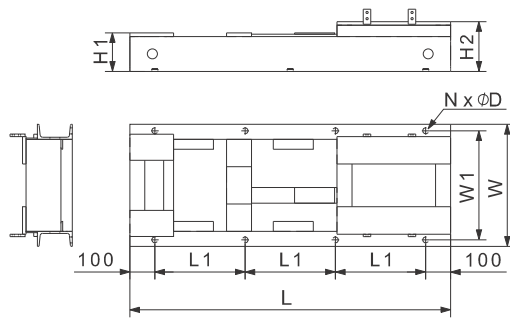

TM05 7711 1513

Fig. 86 C-channel base frame with 8 mounting holes

Base frame number	Dimensions [mm]							
	L	L1	W	W1	H1	H2	N	D
83s	2076	625	780	719	196	331	8	28
84s	2027	609	690	629	196	281	8	28
85s	2006	602	690	629	196	196	8	28
88	2015	605	790	729	196	331	8	28
88s	2192	664	790	729	196	331	8	28
89	2000	600	710	649	196	281	8	28
89s	2180	660	710	649	196	281	8	28
90s	2156	652	710	649	196	196	8	28
91	2120	640	710	649	235	200	8	28
91s	2300	700	710	649	235	200	8	28
92	2000	600	710	649	265	200	8	28
92s	2135	645	710	649	265	200	8	28
93	2210	670	790	729	196	331	8	28
93s	2390	730	790	729	196	331	8	28
94	2180	660	710	649	196	281	8	28
94s	2360	720	710	649	196	281	8	28
95	2150	650	710	649	200	200	8	28
95s	2330	710	710	649	200	200	8	28
98s	2075	625	790	729	196	331	8	28
99s	2060	620	750	689	196	281	8	28
100s	2036	612	750	689	200	200	8	28
103	2030	610	810	749	245	205	8	28
103s	2210	670	810	749	245	205	8	28
104s	2156	652	800	739	196	241	8	28
105	2015	605	800	739	196	291	8	28
105s	2195	665	800	739	196	291	8	28
106	2060	620	810	739	196	291	8	28
106s	2240	680	810	739	196	291	8	28
107	2255	685	810	739	196	291	8	28
107s	2435	745	810	739	196	291	8	28
108	2030	610	840	769	245	205	8	28
108s	2210	670	840	769	245	205	8	28
109	2090	630	840	779	196	291	8	28
109s	2270	690	840	779	196	291	8	28
113s	2066	622	800	739	275	200	8	28
116s	2105	635	710	649	231	196	8	28

NK pump dimensions with C-channel base frames

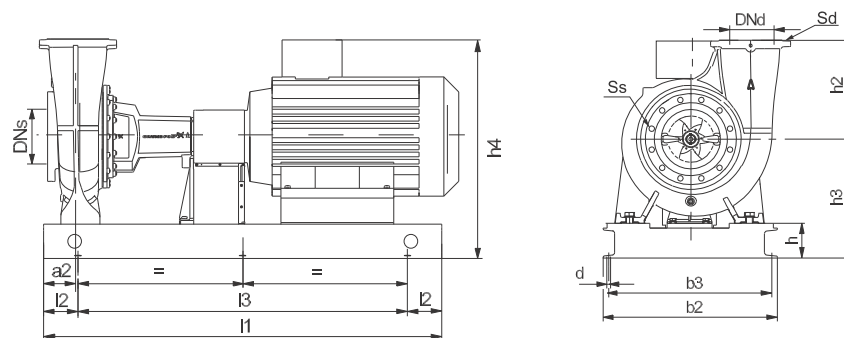

Fig. 87 NK pump with C-channel base frame

TM05 7707 2417

NK pumps, 2-pole

Pump type	Motor data					Dimensions [mm]								Pump with E-motor ³				
	P2 [kW]	Frame size	Make				Base frame No ¹	a2	l1 ¹	l2	l3 ¹	b2 ¹	b3 ¹		d	h	h3	h4 ²
			MG	Siemens	MMG-E	MMG-G												
32-125.1	0.75	80A	•	•	•	•	•	2/2s	60	700/796	100	500/596	300/300	265/265	14	73	185	294
	1.1	80	•	•	•	•	•	2/2s	60	700/796	100	500/596	300/300	265/265	14	73	185	294
	1.5	90S	•	•	•	•	•	5/5s	60	710/806	100	510/606	312/312	277/277	14	73	195	305
	2.2	90L	•	•	•	•	•	5/5s	60	710/806	100	510/606	312/312	277/277	14	73	195	305
32-125	1.1	80	•	•	•	•	•	2/2s	60	700/796	100	500/596	300/300	265/265	14	73	185	294
	1.5	90S	•	•	•	•	•	5/5s	60	710/806	100	510/606	312/312	277/277	14	73	195	305
	2.2	90L	•	•	•	•	•	5/5s	60	710/806	100	510/606	312/312	277/277	14	73	195	305
32-160.1	3	100L	•	•	•	•	•	9/9s	60	750/846	100	550/646	346/346	303/303	19	110	242	362
	1.5	90S	•	•	•	•	•	5/5s	60	710/806	100	510/606	312/312	277/277	14	73	205	315
	2.2	90L	•	•	•	•	•	5/5s	60	710/806	100	510/606	312/312	277/277	14	73	205	315
	4	112M	•	•	•	•	•	14/14s	60	765/855	100	565/655	346/346	303/303	19	114	246	380
32-160	2.2	90L	•	•	•	•	•	5/5s	60	710/806	100	510/606	312/312	277/277	14	73	205	315
	3	100L	•	•	•	•	•	9/9s	60	750/846	100	550/646	346/346	303/303	19	110	242	362
	4	112M	•	•	•	•	•	14/14s	60	765/855	100	565/655	346/346	303/303	19	114	246	380
32-200.1	5.5	132S	•	•	•	•	•	19/19s	60	850/940	100	650/740	341/341	298/298	19	114	274	408
	3	100L	•	•	•	•	•	9/9s	60	750/846	100	550/646	346/346	303/303	19	110	270	390
	4	112M	•	•	•	•	•	14/14s	60	765/855	100	565/655	346/346	303/303	19	114	274	408
	7.5	132S	•	•	•	•	•	19/19s	60	850/940	100	650/740	341/341	298/298	19	114	274	399
32-200	4	112M	•	•	•	•	•	14/14s	60	765/855	100	565/655	346/346	303/303	19	114	274	408
	5.5	132S	•	•	•	•	•	19/19s	60	850/940	100	650/740	341/341	298/298	19	114	274	408
	7.5	132S	•	•	•	•	•	19/19s	60	850/940	100	650/740	341/341	298/298	19	114	274	399
	11	160M	•	•	•	•	•	32/32s	60	990/1100	100	790/900	416/416	373/373	19	114	294	454
32-250	5.5	132S	•	•	•	•	•	20/20s	75	850/980	100	650/780	416/416	373/373	19	114	294	428
	7.5	132S	•	•	•	•	•	20/20s	75	850/980	100	650/780	416/416	373/373	19	114	294	419
	11	160M	•	•	•	•	•	32/32s	75	990/1100	100	790/900	416/416	373/373	19	114	294	454
40-125	15	160M	•	•	•	•	•	32/32s	75	990/1100	100	790/900	416/416	373/373	19	114	294	454
	1.5	90S	•	•	•	•	•	5/5s	60	710/806	100	510/606	312/312	277/277	14	73	195	305
	2.2	90L	•	•	•	•	•	5/5s	60	710/806	100	510/606	312/312	277/277	14	73	195	305
	3	100L	•	•	•	•	•	9/9s	60	750/846	100	550/646	346/346	303/303	19	110	242	362
40-160	4	112M	•	•	•	•	•	14/14s	60	765/855	100	565/655	346/346	303/303	19	114	246	380
	5.5	132S	•	•	•	•	•	19/19s	60	850/940	100	650/740	341/341	298/298	19	114	246	380
	7.5	132S	•	•	•	•	•	19/19s	60	850/940	100	650/740	341/341	298/298	19	114	246	371
	11	160M	•	•	•	•	•	31/31s	60	970/1053	100	770/853	386/386	343/343	19	138	270	430
40-200	5.5	132S	•	•	•	•	•	19/19s	60	850/940	100	650/740	341/341	298/298	19	114	274	408
	7.5	132S	•	•	•	•	•	19/19s	60	850/940	100	650/740	341/341	298/298	19	114	274	399
	11	160M	•	•	•	•	•	32/32s	60	990/1100	100	790/900	416/416	373/373	19	114	294	454
	15	160M	•	•	•	•	•	32/32s	60	990/1100	100	790/900	416/416	373/373	19	114	294	454

Pump type	Motor data					Dimensions [mm]								Pump with E-motor ³					
	P2 [kW]	Frame size	Make					Base frame No ¹	a2	I1 ¹	I2	I3 ¹	b2 ¹		b3 ¹	d	h	h3	h4 ²
			MG	Siemens	MMG-E	MMG-G	MMG-H												
40-250	11	160M	•	•	•	•	•	32/32s	75	990/1100	100	790/900	416/416	373/373	19	114	294	454	
	15	160M	•	•	•	•	•	32/32s	75	990/1100	100	790/900	416/416	373/373	19	114	294	454	
	18.5	160L	•	•	•	•	•	32/32s	75	990/1100	100	790/900	416/416	373/373	19	114	294	454	
	22	180M	•	•	•	•	•	33/33s	75	1005/1105	100	805/905	440/440	388/388	24	154	334	494	
	30	200L	-	•	•	•	•	41/41s	75	1110/1220	100	910/1020	470/470	418/418	24	170	350	655	
40-315	22	180M	•	•	•	•	•	34/34s	75	1150/1286	100	950/1086	470/470	418/418	24	154	354	514	
	30	200L	-	•	•	•	•	111/111s	75	1225/1360	100	1025/1160	480/480	428/428	24	172	372	677	
	37	200L	-	•	•	•	•	111/111s	75	1225/1360	100	1025/1160	480/480	428/428	24	172	372	677	
	45	225M	-	•	•	•	•	52/52s	75	1300/1436	100	1100/1236	510/510	458/458	24	154	379	704	
50-125	3	100L	•	•	•	•	•	9/9s	60	750/846	100	550/646	346/346	303/303	19	110	242	362	
	4	112M	•	•	•	•	•	14/14s	60	765/855	100	565/655	346/346	303/303	19	114	246	380	
	5.5	132S	•	•	•	•	•	19/19s	60	850/940	100	650/740	341/341	298/298	19	114	246	380	
	7.5	132S	•	•	•	•	•	19/19s	60	850/940	100	650/740	341/341	298/298	19	114	246	371	
50-160	5.5	132S	•	•	•	•	•	19/19s	60	850/940	100	650/740	341/341	298/298	19	114	274	408	
	7.5	132S	•	•	•	•	•	19/19s	60	850/940	100	650/740	341/341	298/298	19	114	274	399	
	11	160M	•	•	•	•	•	32/32s	60	990/1100	100	790/900	416/416	373/373	19	114	294	454	
50-200	15	160M	•	•	•	•	•	32/32s	60	990/1100	100	790/900	416/416	373/373	19	114	294	454	
	11	160M	•	•	•	•	•	32/32s	60	990/1100	100	790/900	416/416	373/373	19	114	294	454	
	15	160M	•	•	•	•	•	32/32s	60	990/1100	100	790/900	416/416	373/373	19	114	294	454	
	18.5	160L	•	•	•	•	•	32/32s	60	990/1100	100	790/900	416/416	373/373	19	114	294	454	
50-250	22	180M	•	•	•	•	•	33/33s	60	1005/1105	100	805/905	440/440	388/388	24	154	334	494	
	15	160M	•	•	•	•	•	32/32s	75	990/1100	100	790/900	416/416	373/373	19	114	294	454	
	18.5	160L	•	•	•	•	•	32/32s	75	990/1100	100	790/900	416/416	373/373	19	114	294	454	
	22	180M	•	•	•	•	•	33/33s	75	1005/1105	100	805/905	440/440	388/388	24	154	334	494	
	30	200L	-	•	•	•	•	41/41s	75	1110/1220	100	910/1020	470/470	418/418	24	170	350	655	
	37	200L	-	•	•	•	•	41/41s	75	1110/1220	100	910/1020	470/470	418/418	24	170	350	655	
	30	200L	-	•	•	•	•	42/42s	75	1216/1352	100	1016/1152	500/500	448/448	24	154	379	684	
50-315	37	200L	-	•	•	•	•	42/42s	75	1216/1352	100	1016/1152	500/500	448/448	24	154	379	684	
	45	225M	-	•	•	•	•	52/52s	75	1300/1436	100	1100/1236	510/510	458/458	24	154	379	704	
	55	250M	-	•	•	•	•	60/60s	75	1370/1506	100	1170/1306	596/596	535/535	28	219	444	836	
	4	112M	•	•	•	•	•	14/14s	60	765/855	100	565/655	346/346	303/303	19	114	274	408	
65-125	5.5	132S	•	•	•	•	•	19/19s	60	850/940	100	650/740	341/341	298/298	19	114	274	408	
	7.5	132S	•	•	•	•	•	19/19s	60	850/940	100	650/740	341/341	298/298	19	114	274	399	
	11	160M	•	•	•	•	•	32/32s	60	990/1100	100	790/900	416/416	373/373	19	114	294	454	
65-160	7.5	132S	•	•	•	•	•	19/19s	60	850/940	100	650/740	341/341	298/298	19	114	274	399	
	11	160M	•	•	•	•	•	32/32s	60	990/1100	100	790/900	416/416	373/373	19	114	294	454	
	15	160M	•	•	•	•	•	32/32s	60	990/1100	100	790/900	416/416	373/373	19	114	294	454	
	18.5	160L	•	•	•	•	•	32/32s	60	990/1100	100	790/900	416/416	373/373	19	114	294	454	
65-200	11	160M	•	•	•	•	•	32/32s	75	990/1100	100	790/900	416/416	373/373	19	114	294	454	
	15	160M	•	•	•	•	•	32/32s	75	990/1100	100	790/900	416/416	373/373	19	114	294	454	
	18.5	160L	•	•	•	•	•	32/32s	75	990/1100	100	790/900	416/416	373/373	19	114	294	454	
	22	180M	•	•	•	•	•	33/33s	75	1005/1105	100	805/905	440/440	388/388	24	154	334	494	
	30	200L	-	•	•	•	•	41/41s	75	1110/1220	100	910/1020	470/470	418/418	24	170	350	655	
	37	200L	-	•	•	•	•	41/41s	75	1110/1220	100	910/1020	470/470	418/418	24	170	350	655	
	30	200L	-	•	•	•	•	111/111s	90	1225/1360	100	1025/1160	480/480	428/428	24	172	372	677	
65-250	37	200L	-	•	•	•	•	111/111s	90	1225/1360	100	1025/1160	480/480	428/428	24	172	372	677	
	45	225M	-	•	•	•	•	52/52s	90	1300/1436	100	1100/1236	510/510	458/458	24	154	379	704	
	55	250M	-	•	•	•	•	60/60s	90	1370/1506	100	1170/1306	596/596	535/535	28	219	444	836	
	75	280S	-	•	•	•	•	73/73s	90	1380/1516	100	1180/1316	650/650	589/589	28	251	476	908	
65-315	55	250M	-	•	•	•	•	60/60s	90	1370/1506	100	1170/1306	596/596	535/535	28	219	444	836	
	75	280S	-	•	•	•	•	73/73s	90	1380/1516	100	1180/1316	650/650	589/589	28	251	476	908	
	90	280M	-	•	•	•	•	69/69s	90	1460/1596	100	1260/1396	647/647	586/586	28	251	476	908	
	110	315S	-	•	•	•	•	76/76s	90	1600/1736	100	1400/1536	702/702	641/641	28	288	513	1008	
80-160	11	160M	•	•	•	•	•	32/32s	75	990/1100	100	790/900	416/416	373/373	19	114	294	454	
	15	160M	•	•	•	•	•	32/32s	75	990/1100	100	790/900	416/416	373/373	19	114	294	454	
	18.5	160L	•	•	•	•	•	32/32s	75	990/1100	100	790/900	416/416	373/373	19	114	294	454	
	22	180M	•	•	•	•	•	33/33s	75	1005/1105	100	805/905	440/440	388/388	24	154	334	494	
	30	200L	-	•	•	•	•	41/41s	75	1110/1220	100	910/1020	470/470	418/418	24	170	350	655	
80-200	22	180M	•	•	•	•	•	34/34s	75	1150/1286	100	950/1086	470/470	418/418	24	154	334	494	
	30	200L	-	•	•	•	•	111/111s	75	1225/1360	100	1025/1160	480/480	428/428	24	172	352	657	
	37	200L	-	•	•	•	•	111/111s	75	1225/1360	100	1025/1160	480/480	428/428	24	172	352	657	
	45	225M	-	•	•	•	•	51/51s	75	1230/1366	100	1030/1166	520/520	468/468	24	197	377	702	
	55	250M	-	•	•	•	•	59/59s	75	1330/1466	100	1130/1266	596/596	535/535	28	266	446	838	

Pump type	Motor data					Dimensions [mm]								Pump with E-motor ³				
	P2 [kW]	Frame size	Make				Base frame No ¹	a2	l1 ¹	l2	l3 ¹	b2 ¹	b3 ¹		d	h	h3	h4 ²
			MG	Siemens	MMG-E	MMG-G												
80-250	45	225M	-	•	•	•	•	52/52s	90	1300/1436	100	1100/1236	510/510	458/458	24	154	379	704
	55	250M	-	•	•	•	•	60/60s	90	1370/1506	100	1170/1306	596/596	535/535	28	219	444	836
	75	280S	-	•	•	•	•	73/73s	90	1380/1516	100	1180/1316	650/650	589/589	28	251	476	908
	90	280M	-	•	•	•	•	69/69s	90	1460/1596	100	1260/1396	647/647	586/586	28	251	476	908
80-315	90	280M	-	•	•	•	•	69/69s	90	1460/1596	100	1260/1396	647/647	586/586	28	251	501	933
	110	315S	-	•	•	•	•	76/76s	90	1600/1736	100	1400/1536	702/702	641/641	28	288	538	1033
	132	315M	-	•	•	•	•	76/76s	90	1600/1736	100	1400/1536	702/702	641/641	28	288	538	1033
100-160	160	315L	-	•	•	•	•	82/82s	90	1580/1716	100	1380/1516	690/690	629/629	28	265	515	1010
	18.5	160L	•	•	•	•	•	32/32s	90	990/1100	100	790/900	416/416	373/373	19	114	314	474
	22	180M	•	•	•	•	•	33/33s	90	1005/1105	100	805/905	440/440	388/388	24	154	354	514
100-200	30	200L	-	•	•	•	•	41/41s	90	1110/1220	100	910/1020	470/470	418/418	24	170	370	675
	30	200L	-	•	•	•	•	111/111s	90	1225/1360	100	1025/1160	480/480	428/428	24	172	372	677
	37	200L	-	•	•	•	•	111/111s	90	1225/1360	100	1025/1160	480/480	428/428	24	172	372	677
100-250	45	225M	-	•	•	•	•	52/52s	90	1300/1436	100	1100/1236	510/510	458/458	24	154	379	704
	55	250M	-	•	•	•	•	60/60s	90	1370/1506	100	1170/1306	596/596	535/535	28	219	444	836
	75	280S	-	•	•	•	•	73/73s	90	1380/1516	100	1180/1316	650/650	589/589	28	251	476	908
100-315	55	250M	-	•	•	•	•	60/60s	90	1370/1506	100	1170/1306	596/596	535/535	28	219	444	836
	75	280S	-	•	•	•	•	73/73s	90	1380/1516	100	1180/1316	650/650	589/589	28	251	476	908
	90	280M	-	•	•	•	•	69/69s	90	1460/1596	100	1260/1396	647/647	586/586	28	251	476	908
100-315	110	315S	-	•	•	•	•	76/76s	90	1600/1736	100	1400/1536	702/702	641/641	28	288	513	1008
	132	315M	-	•	•	•	•	76/76s	90	1600/1736	100	1400/1536	702/702	641/641	28	288	513	1008
	110	315S	-	•	•	•	•	76/76s	90	1600/1736	100	1400/1536	702/702	641/641	28	288	538	1033
125-200	132	315M	-	•	•	•	•	76/76s	90	1600/1736	100	1400/1536	702/702	641/641	28	288	538	1033
	160	315L	-	•	•	•	•	82/82s	90	1580/1716	100	1380/1516	690/690	629/629	28	265	515	1010
	200	315L	-	•	•	•	•	82/82s	90	1580/1716	100	1380/1516	690/690	629/629	28	265	515	1010
125-250	45	225M	-	•	•	•	•	52/52s	90	1300/1436	100	1100/1236	510/510	458/458	24	154	404	729
	55	250M	-	•	•	•	•	60/60s	90	1370/1506	100	1170/1306	596/596	535/535	28	219	469	861
	75	280S	-	•	•	•	•	73/73s	90	1380/1516	100	1180/1316	650/650	589/589	28	251	501	933
125-315	90	280M	-	•	•	•	•	69/69s	90	1460/1596	100	1260/1396	647/647	586/586	28	251	501	933
	110	315S	-	•	•	•	•	76/76s	90	1600/1736	100	1400/1536	702/702	641/641	28	288	538	1033
	132	315M	-	•	•	•	•	76/76s	90	1600/1736	100	1400/1536	702/702	641/641	28	288	538	1033
150-200	160	315L	-	•	•	•	•	82/82s	90	1580/1716	100	1380/1516	690/690	629/629	28	265	515	1010
	200	315L	-	•	•	•	•	82/82s	90	1580/1716	100	1380/1516	690/690	629/629	28	265	515	1010
	132	315M	-	•	•	•	•	75/75s	110	1600/1776	100	1400/1576	700/700	639/639	28	231	511	1006
150-250	160	315L	-	•	•	•	•	81/81s	110	1688/1830	100	1488/1630	690/690	629/629	28	231	511	1006
	200	315L	-	•	•	•	•	81/81s	110	1688/1830	100	1488/1630	690/690	629/629	28	231	511	1006
	250	315	-	•	•	•	•	96/96s	110	1800/1976	100	1600/1776	750/750	689/689	28	235	515	983
150-315.2	75	280S	-	•	•	•	•	71/71s	110	1370/1506	100	1170/1306	637/637	576/576	28	196	476	908
	90	280M	-	•	•	•	•	68/68s	110	1520/1660	100	1320/1460	637/637	576/576	28	196	476	908
	110	315S	-	•	•	•	•	75/75s	110	1600/1776	100	1400/1576	700/700	639/639	28	231	511	1006
150-315.2	132	315M	-	•	•	•	•	75/75s	110	1600/1776	100	1400/1576	700/700	639/639	28	231	511	1006
	160	315L	-	•	•	•	•	81/81s	110	1688/1830	100	1488/1630	690/690	629/629	28	231	511	1006
	200	315L	-	•	•	•	•	81/81s	110	1688/1830	100	1488/1630	690/690	629/629	28	231	511	1006
150-315.2	250	315	-	•	•	•	•	96/96s	110	1800/1976	100	1600/1776	750/750	689/689	28	235	515	983
	160	315L	-	•	•	•	•	81/81s	110	1688/1830	100	1488/1630	690/690	629/629	28	231	511	1006
150-315.2	200	315L	-	•	•	•	•	81/81s	110	1688/1830	100	1488/1630	690/690	629/629	28	231	511	1006

¹ Pump with standard coupling / pump with spacer coupling.
² P2 less than or equal to 22 kW, pump with MG motor; P2 greater than or equal to 30 kW, pump with Siemens motor.
³ For pump dimensions with E-motors, see the relevant pages in section 17. *Dimensional drawings and technical data.*

NK pumps, 4-pole

Pump type	Motor data					Dimensions [mm]								Pump with E-motor ³				
	P2 [kW]	Frame size	Make				Base frame No ¹	a2	l1 ¹	l2	l3 ¹	b2 ¹	b3 ¹		d	h	h3	h4 ²
			MG	Siemens	MMG-E	MMG-G												
32-125.1	0.25	71A	•	•	•	•	•	1/1s	60	645/731	100	445/531	330/330	295/295	14	73	205	314
	0.37	71B	•	•	•	•	•	1/1s	60	645/731	100	445/531	330/330	295/295	14	73	205	314
32-125	0.25	71A	•	•	•	•	•	1/1s	60	645/731	100	445/531	330/330	295/295	14	73	205	314
	0.37	71B	•	•	•	•	•	1/1s	60	645/731	100	445/531	330/330	295/295	14	73	205	314
32-160.1	0.25	71A	•	•	•	•	•	1/1s	60	645/731	100	445/531	330/330	295/295	14	73	205	314
	0.37	71B	•	•	•	•	•	1/1s	60	645/731	100	445/531	330/330	295/295	14	73	205	314
	0.55	80A	•	•	•	•	•	2/2s	60	700/796	100	500/596	300/300	265/265	14	73	205	314
32-160	0.25	71A	•	•	•	•	•	1/1s	60	645/731	100	445/531	330/330	295/295	14	73	205	314
	0.37	71B	•	•	•	•	•	1/1s	60	645/731	100	445/531	330/330	295/295	14	73	205	314
	0.55	80A	•	•	•	•	•	2/2s	60	700/796	100	500/596	300/300	265/265	14	73	205	314
	0.75	80C	•	•	•	•	•	5/5s	60	710/806	100	510/606	312/312	277/277	14	73	205	325
32-200.1	0.37	71B	•	•	•	•	•	1/1s	60	645/731	100	445/531	330/330	295/295	14	73	233	342
	0.55	80A-C	•	•	•	•	•	3/3s	60	685/781	100	485/581	400/400	365/365	14	77	257	366
	0.75	90S	•	•	•	•	•	6/6s	60	730/826	100	530/626	400/360	365/325	14	77	247	367
32-200	0.55	80A	•	•	•	•	•	3/3s	60	685/781	100	485/581	400/400	365/365	14	77	257	366
	0.75	90S	•	•	•	•	•	6/6s	60	730/826	100	530/626	400/360	365/325	14	77	247	367
	1.1	90S	•	•	•	•	•	6/6s	60	730/826	100	530/626	400/360	365/325	14	77	257	367
	1.5	90L	•	•	•	•	•	6/6s	60	730/826	100	530/626	400/360	365/325	14	77	257	367
32-250	0.75	90S	•	•	•	•	•	6/6s	75	730/826	100	530/626	400/360	365/325	14	77	257	377
	1.1	90S	•	•	•	•	•	6/6s	75	730/826	100	530/626	400/360	365/325	14	77	257	367
	1.5	90L	•	•	•	•	•	6/6s	75	730/826	100	530/626	400/360	365/325	14	77	257	367
40-125	2.2	100L	•	•	•	•	•	10/10s	75	740/876	100	540/676	416/416	373/373	19	114	294	414
	0.25	71A	•	•	•	•	•	1/1s	60	645/731	100	445/531	330/330	295/295	14	73	205	314
	0.37	71B	•	•	•	•	•	1/1s	60	645/731	100	445/531	330/330	295/295	14	73	205	314
	0.55	80A	•	•	•	•	•	2/2s	60	700/796	100	500/596	300/300	265/265	14	73	185	294
40-160	0.37	71B	•	•	•	•	•	1/1s	60	645/731	100	445/531	330/330	295/295	14	73	205	314
	0.55	80A	•	•	•	•	•	2/2s	60	700/796	100	500/596	300/300	265/265	14	73	205	314
	0.75	90S	•	•	•	•	•	5/5s	60	710/806	100	510/606	312/312	277/277	14	73	205	325
40-200	1.1	90S	•	•	•	•	•	5/5s	60	710/806	100	510/606	312/312	277/277	14	73	205	315
	0.75	90S	•	•	•	•	•	6/6s	60	730/826	100	530/626	400/360	365/325	14	77	247	367
	1.1	90S	•	•	•	•	•	6/6s	60	730/826	100	530/626	400/360	365/325	14	77	257	367
	1.5	90L	•	•	•	•	•	6/6s	60	730/826	100	530/626	400/360	365/325	14	77	257	367
40-250	2.2	100L	•	•	•	•	•	9/9s	60	750/846	100	550/646	346/346	303/303	19	110	270	390
	1.5	90L	•	•	•	•	•	6/6s	75	730/826	100	530/626	400/360	365/325	14	77	257	367
	2.2	100L	•	•	•	•	•	10/10s	75	740/876	100	540/676	416/416	373/373	19	114	294	414
	3	100L	•	•	•	•	•	10/10s	75	740/876	100	540/676	416/416	373/373	19	114	294	414
40-315	3	100L	•	•	•	•	•	11/11s	75	900/1036	100	700/836	416/416	373/373	19	114	314	434
	4	112M	•	•	•	•	•	16/16s	75	900/1036	100	700/836	446/446	403/403	19	114	314	448
	5.5	132S	•	•	•	•	•	21/21As	75	980/1030	100	780/830	447/406	404/363	19	114	314	439
	7.5	132M	•	•	•	•	•	21/21As	75	980/1030	100	780/830	447/406	404/363	19	114	314	439
50-125	0.37	71B	•	•	•	•	•	1/1s	60	645/731	100	445/531	330/330	295/295	14	73	205	314
	0.55	80A	•	•	•	•	•	2/2s	60	700/796	100	500/596	300/300	265/265	14	73	205	314
	0.75	90S	•	•	•	•	•	5/5s	60	710/806	100	510/606	312/312	277/277	14	73	205	325
	1.1	90S	•	•	•	•	•	5/5s	60	710/806	100	510/606	312/312	277/277	14	73	205	315
50-160	0.55	80A-C	•	•	•	•	•	3/3s	60	685/781	100	485/581	400/400	365/365	14	77	257	366
	0.75	90S	•	•	•	•	•	6/6s	60	730/826	100	530/626	400/360	365/325	14	77	247	367
	1.1	90S	•	•	•	•	•	6/6s	60	730/826	100	530/626	400/360	365/325	14	77	257	367
	1.5	90L	•	•	•	•	•	6/6s	60	730/826	100	530/626	400/360	365/325	14	77	257	367
	2.2	100L	•	•	•	•	•	9/9s	60	750/846	100	550/646	346/346	303/303	19	110	270	390
	1.1	90S	•	•	•	•	•	6/6s	60	730/826	100	530/626	400/360	365/325	14	77	257	367
50-200	1.5	90L	•	•	•	•	•	6/6s	60	730/826	100	530/626	400/360	365/325	14	77	257	367
	2.2	100L	•	•	•	•	•	9/9s	60	750/846	100	550/646	346/346	303/303	19	110	270	390
	3	100L	•	•	•	•	•	9/9s	60	750/846	100	550/646	346/346	303/303	19	110	270	390
50-250	2.2	100L	•	•	•	•	•	10/10s	75	740/876	100	540/676	416/416	373/373	19	114	294	414
	3	100L	•	•	•	•	•	10/10s	75	740/876	100	540/676	416/416	373/373	19	114	294	414
	4	112M	•	•	•	•	•	15/15s	75	755/885	100	555/685	416/416	373/373	19	114	294	428
50-315	4	112M	•	•	•	•	•	17/17s	75	930/1030	100	730/830	456/456	413/413	19	114	339	473
	5.5	132S	•	•	•	•	•	22/22s	75	1010/1080	100	810/880	446/446	403/403	19	114	339	464
	7.5	132M	•	•	•	•	•	22/22s	75	1010/1080	100	810/880	446/446	403/403	19	114	339	464
	11	160MB	•	•	•	•	•	28/28s	75	1140/1250	100	940/1050	446/446	403/403	19	114	339	499

Pump type	Motor data					Dimensions [mm]								Pump with E-motor ³					
	P2 [kW]	Frame size	Make					Base frame No ¹	a2	I1 ¹	I2	I3 ¹	b2 ¹		b3 ¹	d	h	h3	h4 ²
			MG	Siemens	MMG-E	MMG-G	MMG-H												
65-125	0.55	80A-C	•	•	•	•	•	3/3s	60	685/781	100	485/581	400/400	365/365	14	77	257	366	
	0.75	90S	•	•	•	•	•	6/6s	60	730/826	100	530/626	400/360	365/325	14	77	247	367	
	1.1	90S	•	•	•	•	•	6/6s	60	730/826	100	530/626	400/360	365/325	14	77	257	367	
65-160	0.75	90S	•	•	•	•	•	6/6s	60	720/826	100	530/626	400/360	365/325	14	77	247	367	
	1.1	90S	•	•	•	•	•	6/6s	60	730/826	100	530/626	400/360	365/325	14	77	257	367	
	1.5	90L	•	•	•	•	•	6/6s	60	730/826	100	530/626	400/360	365/325	14	77	257	367	
65-200	2.2	100L	•	•	•	•	•	9/9s	60	750/846	100	550/646	346/346	303/303	19	110	270	390	
	1.5	90L	•	•	•	•	•	6/6As	75	730/850	100	530/650	400/400	365/365	14	77	257	367	
	2.2	100L	•	•	•	•	•	10/10s	75	740/876	100	540/676	416/416	373/373	19	114	294	414	
65-250	3	100L	•	•	•	•	•	10/10s	75	740/876	100	540/676	416/416	373/373	19	114	294	414	
	4	112M	•	•	•	•	•	15/15s	75	755/885	100	555/685	416/416	373/373	19	114	294	428	
	3	100L	•	•	•	•	•	11/11s	90	900/1036	100	700/836	416/416	373/373	19	114	314	434	
65-315	4	112M	•	•	•	•	•	16/16s	90	900/1036	100	700/836	446/446	403/403	19	114	314	448	
	5.5	132S	•	•	•	•	•	21/21s	90	980/1116	100	780/916	447/447	404/404	19	114	314	439	
	7.5	132M	•	•	•	•	•	21/21s	90	980/1116	100	780/916	447/447	404/404	19	114	314	439	
80-160	5.5	132S	•	•	•	•	•	22/22s	90	1010/1080	100	810/880	446/446	403/403	19	114	339	464	
	7.5	132M	•	•	•	•	•	22/22s	90	1010/1080	100	810/880	446/446	403/403	19	114	339	464	
	11	160MA	•	•	•	•	•	28/28s	90	1140/1250	100	940/1050	446/446	403/403	19	114	339	499	
80-200	15	160L	•	•	•	•	•	28/28s	90	1140/1250	100	940/1050	446/446	403/403	19	114	339	499	
	1.5	90L	•	•	•	•	•	6/6As	75	730/850	100	530/650	400/400	365/365	14	77	257	367	
	2.2	100L	•	•	•	•	•	10/10s	75	740/876	100	540/676	416/416	373/373	19	114	294	414	
80-250	3	100L	•	•	•	•	•	10/10s	75	740/876	100	540/676	416/416	373/373	19	114	294	414	
	4	112M	•	•	•	•	•	15/15s	75	755/885	100	555/685	416/416	373/373	19	114	294	428	
	2.2	100L	•	•	•	•	•	11/11s	75	900/1036	100	700/836	416/416	373/373	19	114	294	414	
80-315	3	100L	•	•	•	•	•	11/11s	75	900/1036	100	700/836	416/416	373/373	19	114	294	414	
	4	112M	•	•	•	•	•	16/16s	75	900/1036	100	700/836	446/446	403/403	19	114	294	428	
	5.5	132S	•	•	•	•	•	21/21s	75	980/1116	100	780/916	447/447	404/404	19	114	294	419	
80-400	7.5	132M	•	•	•	•	•	21/21s	75	980/1116	100	780/916	447/447	404/404	19	114	294	419	
	5.5	132S	•	•	•	•	•	21/21s	90	980/1116	100	780/916	447/447	404/404	19	114	314	439	
	7.5	132M	•	•	•	•	•	21/21s	90	980/1116	100	780/916	447/447	404/404	19	114	314	439	
100-160	11	160MB	•	•	•	•	•	27/27s	90	1140/1270	100	940/1070	446/446	403/403	19	114	314	474	
	11	160MB	•	•	•	•	•	28/28s	90	1140/1250	100	940/1050	446/446	403/403	19	114	364	524	
	15	160L	•	•	•	•	•	28/28s	90	1140/1250	100	940/1050	446/446	403/403	19	114	364	524	
100-200	18.5	180M	-	•	•	•	•	35/35s	90	1180/1285	100	980/1085	489/489	437/437	24	154	404	662	
	22	180L	-	•	•	•	•	35/35s	90	1180/1285	100	980/1085	489/489	437/437	24	154	404	662	
	18.5	180M	-	•	•	•	•	36/36s	90	1200/1370	100	1000/1170	610/610	558/558	24	160	440	698	
100-250	22	180L	-	•	•	•	•	36/36s	90	1200/1370	100	1000/1170	610/610	558/558	24	160	440	698	
	30	200L	-	•	•	•	•	43/43s	90	1240/1420	100	1040/1220	610/610	558/558	24	156	436	741	
	37	225S	-	•	•	•	•	53/53s	90	1310/1486	100	1110/1286	610/610	558/558	24	160	440	765	
100-315	45	225M	-	•	•	•	•	53/53s	90	1310/1486	100	1110/1286	610/610	558/558	24	160	440	765	
	2.2	100L	•	•	•	•	•	10/10s	90	740/876	100	540/676	416/416	373/373	19	114	314	434	
	3	100L	•	•	•	•	•	10/10s	90	740/876	100	540/676	416/416	373/373	19	114	314	434	
100-400	4	112M	•	•	•	•	•	15/15s	90	755/885	100	555/685	416/416	373/373	19	114	314	448	
	4	112M	•	•	•	•	•	16/16s	90	900/1036	100	700/836	446/446	403/403	19	114	314	448	
	5.5	132S	•	•	•	•	•	21/21s	90	980/1116	100	780/916	447/447	404/404	19	114	314	439	
125-200	7.5	132M	•	•	•	•	•	21/21s	90	980/1116	100	780/916	447/447	404/404	19	114	314	439	
	11	160MB	•	•	•	•	•	27/27s	90	1140/1270	100	940/1070	446/446	403/403	19	114	314	474	
	7.5	132M	•	•	•	•	•	22/22s	90	1010/1080	100	810/880	446/446	403/403	19	114	339	464	
125-250	11	160MB	•	•	•	•	•	28/28s	90	1140/1250	100	940/1050	446/446	403/403	19	114	339	499	
	15	160L	•	•	•	•	•	28/28s	90	1140/1250	100	940/1050	446/446	403/403	19	114	339	499	
	15	160L	•	•	•	•	•	28/28s	90	1140/1250	100	940/1050	446/446	403/403	19	114	364	524	
125-315	18.5	180M	-	•	•	•	•	35/35s	90	1180/1285	100	980/1085	489/489	437/437	24	154	404	662	
	22	180L	-	•	•	•	•	35/35s	90	1180/1285	100	980/1085	489/489	437/437	24	154	404	662	
	30	200L	-	•	•	•	•	42/42s	90	1216/1352	100	1016/1152	500/500	448/448	24	154	404	709	
125-400	22	180L	-	•	•	•	•	36/36s	110	1200/1370	100	1000/1170	610/610	558/558	24	160	440	698	
	30	200L	-	•	•	•	•	43/43s	110	1240/1420	100	1040/1220	610/610	558/558	24	156	436	741	
	37	225S	-	•	•	•	•	53/53s	110	1310/1486	100	1110/1286	610/610	558/558	24	160	440	765	
125-450	45	225M	-	•	•	•	•	53/53s	110	1310/1486	100	1110/1286	610/610	558/558	24	160	440	765	
	55	250M	-	•	•	•	•	61/61s	110	1390/1566	100	1190/1366	644/644	583/583	28	196	476	868	
	5.5	132S	•	•	•	•	•	22/22s	90	1010/1080	100	810/880	446/446	403/403	19	114	364	489	
125-500	7.5	132M	•	•	•	•	•	22/22s	90	1010/1080	100	810/880	446/446	403/403	19	114	364	489	
	11	160MB	•	•	•	•	•	28/28s	90	1140/1250	100	940/1050	446/446	403/403	19	114	364	524	
	15	160L	•	•	•	•	•	28/28s	90	1140/1250	100	940/1050	446/446	403/403	19	114	364	524	

Pump type	Motor data					Dimensions [mm]								Pump with E-motor ³					
	P2 [kW]	Frame size	Make					Base frame No ¹	a2	l1 ¹	l2	l3 ¹	b2 ¹		b3 ¹	d	h	h3	h4 ²
			MG	Siemens	MMG-E	MMG-G	MMG-H												
125-250	11	160MB	•	•	•	•	•	28/28s	90	1140/1250	100	940/1050	446/446	403/403	19	114	364	524	
	15	160L	•	•	•	•	•	28/28s	90	1140/1250	100	940/1050	446/446	403/403	19	114	364	524	
	18.5	180M	-	•	•	•	•	35/35s	90	1180/1285	100	980/1085	489/489	437/437	24	154	404	662	
	22	180L	-	•	•	•	•	35/35s	90	1180/1285	100	980/1085	489/489	437/437	24	154	404	662	
	30	200L	-	•	•	•	•	42/42s	90	1216/1352	100	1016/1152	500/500	448/448	24	154	404	709	
125-315	18.5	180M	-	•	•	•	•	36/36s	110	1200/1370	100	1000/1170	610/610	558/558	24	160	440	698	
	22	180L	-	•	•	•	•	36/36s	110	1200/1370	100	1000/1170	610/610	558/558	24	160	440	698	
	30	200L	-	•	•	•	•	43/43s	110	1240/1420	100	1040/1220	610/610	558/558	24	156	436	741	
	37	225S	-	•	•	•	•	53/53s	110	1310/1486	100	1110/1286	610/610	558/558	24	160	440	765	
	45	225M	-	•	•	•	•	53/53s	110	1310/1486	100	1110/1286	610/610	558/558	24	160	440	765	
125-400	37	225S	-	•	•	•	•	54/54s	110	1305/1440	100	1105/1240	610/610	558/558	24	160	475	800	
	45	225M	-	•	•	•	•	54/54s	110	1305/1440	100	1105/1240	610/610	558/558	24	160	475	800	
	55	250M	-	•	•	•	•	62/62s	110	1370/1506	100	1170/1306	630/630	569/569	28	196	511	903	
	75	280S	-	•	•	•	•	67/67s	110	1520/1656	100	1320/1456	660/660	599/599	28	196	511	943	
	90	280M	-	•	•	•	•	67/67s	110	1520/1656	100	1320/1456	660/660	599/599	28	196	511	943	
125-500	55	250M	-	•	•	•	•	57/57s	110	1530/1706	100	1330/1506	680/680	619/619	28	196	596	988	
	75	280S	-	•	•	•	•	65/65s	110	1660/1836	100	1460/1636	690/690	629/629	28	196	596	1028	
	90	280M	-	•	•	•	•	65/65s	110	1660/1836	100	1460/1636	690/690	629/629	28	196	596	1028	
	110	315S	-	•	•	•	•	79/79s	110	1700/1876	100	1500/1676	690/690	629/629	28	196	596	1091	
	132	315M	-	•	•	•	•	84/84s	110	1850/2027	100	1650/1827	690/690	629/629	28	196	596	1091	
150-200	160	315L	-	•	•	•	•	84/84s	110	1850/2027	100	1650/1827	690/690	629/629	28	196	596	1091	
	7.5	132M	•	•	•	•	•	23/23s	110	1030/1180	100	830/980	591/591	548/548	19	116	396	521	
	11	160MB	•	•	•	•	•	29/29s	110	1160/1336	100	960/1136	586/586	543/543	19	116	396	556	
	15	160L	•	•	•	•	•	29/29s	110	1160/1336	100	960/1136	586/586	543/543	19	116	396	556	
	15	160L	•	•	•	•	•	29/29s	110	1160/1336	100	960/1136	586/586	543/543	19	116	396	556	
150-250	18.5	180M	-	•	•	•	•	36/36s	110	1200/1370	100	1000/1170	610/610	558/558	24	160	440	698	
	22	180L	-	•	•	•	•	36/36s	110	1200/1370	100	1000/1170	610/610	558/558	24	160	440	698	
	30	200L	-	•	•	•	•	43/43s	110	1240/1420	100	1040/1220	610/610	558/558	24	156	436	741	
	37	225S	-	•	•	•	•	53/53s	110	1310/1486	100	1110/1286	610/610	558/558	24	160	440	765	
	45	225M	-	•	•	•	•	53/53s	110	1310/1486	100	1110/1286	610/610	558/558	24	160	440	765	
150-315.2	22	180L	-	•	•	•	•	36/36s	110	1200/1370	100	1000/1170	610/610	558/558	24	160	440	698	
	30	200L	-	•	•	•	•	43/43s	110	1240/1420	100	1040/1220	610/610	558/558	24	156	436	741	
	37	225S	-	•	•	•	•	53/53s	110	1310/1486	100	1110/1286	610/610	558/558	24	160	440	765	
	45	225M	-	•	•	•	•	53/53s	110	1310/1486	100	1110/1286	610/610	558/558	24	160	440	765	
	55	250M	-	•	•	•	•	61/61s	110	1390/1566	100	1190/1366	644/644	583/583	28	196	476	868	
150-315	75	280S	-	•	•	•	•	68/68s	110	1520/1660	100	1320/1460	637/637	576/576	28	196	476	908	
	37	225S	-	•	•	•	•	53/53s	110	1310/1486	100	1110/1286	610/610	558/558	24	160	440	765	
	45	225M	-	•	•	•	•	53/53s	110	1310/1486	100	1110/1286	610/610	558/558	24	160	440	765	
	55	250M	-	•	•	•	•	61/61s	110	1390/1566	100	1190/1366	644/644	583/583	28	196	476	868	
	75	280S	-	•	•	•	•	68/68s	110	1520/1660	100	1320/1460	637/637	576/576	28	196	476	908	
150-400	90	280M	-	•	•	•	•	68/68s	110	1520/1660	100	1320/1460	637/637	576/576	28	196	476	908	
	55	250M	-	•	•	•	•	62/62s	110	1370/1506	100	1170/1306	630/630	569/569	28	196	511	903	
	75	280S	-	•	•	•	•	67/67s	110	1520/1656	100	1320/1456	660/660	599/599	28	196	511	943	
	90	280M	-	•	•	•	•	67/67s	110	1520/1656	100	1320/1456	660/660	599/599	28	196	511	943	
	110	315S	-	•	•	•	•	74/74s	110	1540/1676	100	1275/1411	698/698	637/637	28	196	511	1006	
150-500	132	315M	-	•	•	•	•	85/85s	110	1830/2006	100	1630/1806	690/690	629/629	28	196	511	1006	
	160	315L	-	•	•	•	•	85/85s	110	1830/2006	100	1630/1806	690/690	629/629	28	196	511	1006	
	132	315M	-	•	•	•	•	84/84s	110	1850/2027	100	1650/1827	690/690	629/629	28	196	596	1091	
	160	315L	-	•	•	•	•	84/84s	110	1850/2027	100	1650/1827	690/690	629/629	28	196	596	1091	
	200	315L	-	•	•	•	•	84/84s	110	1850/2027	100	1650/1827	690/690	629/629	28	196	596	1091	
200-400	37	225S	-	•	•	•	•	49/49s	110	1460/1636	100	1260/1436	660/660	608/608	24	156	556	881	
	45	225M	-	•	•	•	•	49/49s	110	1460/1636	100	1260/1436	660/660	608/608	24	156	556	881	
	55	250M	-	•	•	•	•	57/57s	110	1530/1706	100	1330/1506	680/680	619/619	28	196	596	988	
	75	280S	-	•	•	•	•	65/65s	110	1660/1836	100	1460/1636	690/690	629/629	28	196	596	1028	
	90	280M	-	•	•	•	•	65/65s	110	1660/1836	100	1460/1636	690/690	629/629	28	196	596	1028	
200-450	110	315S	-	•	•	•	•	79/79s	110	1700/1876	100	1500/1676	690/690	629/629	28	196	596	1091	
	132	315M	-	•	•	•	•	84/84s	110	1850/2027	100	1650/1827	690/690	629/629	28	196	596	1091	
	75	280S	-	•	•	•	•	65/65s	110	1660/1836	100	1460/1636	690/690	629/629	28	196	596	1028	
	90	280M	-	•	•	•	•	65/65s	110	1660/1836	100	1460/1636	690/690	629/629	28	196	596	1028	
	110	315S	-	•	•	•	•	79/79s	110	1700/1876	100	1500/1676	690/690	629/629	28	196	596	1091	
132	315M	-	•	•	•	•	84/84s	110	1850/2027	100	1650/1827	690/690	629/629	28	196	596	1091		
160	315L	-	•	•	•	•	84/84s	110	1850/2027	100	1650/1827	690/690	629/629	28	196	596	1091		

Pump type	Motor data					Dimensions [mm]								Pump with E-motor ³				
	P2 [kW]	Frame size	Make				Base frame No ¹	a2	I1 ¹	I2	I3 ¹	b2 ¹	b3 ¹		d	h	h3	h4 ²
			MG	Siemens	MMG-E	MMG-G												
250-350	37	225S	-	•	•	•	•	50/50s	110	1504/1680	100	1304/1480	660/660	608/608	24	156	606	931
	45	225M	-	•	•	•	•	50/50s	110	1504/1680	100	1304/1480	660/660	608/608	24	156	606	931
	55	250M	-	•	•	•	•	58/58s	110	1568/1744	100	1368/1544	780/780	719/719	28	196	646	1038
	75	280S	-	•	•	•	•	66/66s	110	1700/1876	100	1500/1676	780/780	719/719	28	196	646	1078
	90	280M	-	•	•	•	•	66/66s	110	1700/1876	100	1500/1676	780/780	719/719	28	196	646	1078
250-400	45	225M	-	•	•	•	•	50/50s	110	1504/1680	100	1304/1480	660/660	608/608	24	156	606	931
	55	250M	-	•	•	•	•	58/58s	110	1568/1744	100	1368/1544	780/780	719/719	28	196	646	1038
	75	280S	-	•	•	•	•	66/66s	110	1700/1876	100	1500/1676	780/780	719/719	28	196	646	1078
	90	280M	-	•	•	•	•	66/66s	110	1700/1876	100	1500/1676	780/780	719/719	28	196	646	1078
	110	315S	-	•	•	•	•	78/78s	110	1710/1886	100	1510/1686	780/780	719/719	28	196	646	1141
	132	315M	-	•	•	•	•	83/83s	110	1900/2076	100	1700/1875	780/780	719/719	28	196	646	1141
250-450	160	315L	-	•	•	•	•	83/83s	110	1900/2076	100	1700/1875	780/780	719/719	28	196	646	1141
	75	280S	-	•	•	•	•	66/66s	110	1700/1876	100	1500/1676	780/780	719/719	28	196	646	1078
	90	280M	-	•	•	•	•	66/66s	110	1700/1876	100	1500/1676	780/780	719/719	28	196	646	1078
	110	315S	-	•	•	•	•	78/78s	110	1710/1886	100	1510/1686	780/780	719/719	28	196	646	1141
	132	315M	-	•	•	•	•	83/83s	110	1900/2076	100	1700/1875	780/780	719/719	28	196	646	1141
250-500	160	315L	-	•	•	•	•	83/83s	110	1900/2076	100	1700/1875	780/780	719/719	28	196	646	1141
	200	315L	-	•	•	•	•	83/83s	110	1900/2076	100	1700/1875	780/780	719/719	28	196	646	1141
	160	315L	-	•	•	•	•	83/83s	110	1900/2076	100	1700/1875	780/780	719/719	28	196	646	1141
	200	315L	-	•	•	•	•	83/83s	110	1900/2076	100	1700/1875	780/780	719/719	28	196	646	1141
250-500	250	315	-	•	•	•	-	98/98s	110	1900/2075	100	1700/1875	790/790	729/729	28	196	646	1114
	315	315	-	•	•	•	-	98/98s	110	1900/2075	100	1700/1875	790/790	729/729	28	196	646	1114

¹ Pump with standard coupling / pump with spacer coupling.

² P2 less than or equal to 15 kW, pump with MG motor; P2 greater than or equal to 18.5 kW, pump with Siemens motor.

³ For pump dimensions with E-motors, see the relevant pages in section 17. *Dimensional drawings and technical data*.

NK pumps, 6-pole

Pump type	Motor data						Dimensions [mm]								Pump with E-motor ³			
	P2 [kW]	Frame size	Make				Base frame No ¹	a2	l1 ¹	l2	l3 ¹	b2 ¹	b3 ¹	d		h	h3	h4 ²
			MG	Siemens	MMG-E	MMG-G												
100-160	0.55	80M	-	•	•	•	•	3/3As	90	685/800	100	485/600	400/400	365/365	14	77	277	397
	0.75	90S	-	•	•	•	•	6/6As	90	730/850	100	530/650	400/400	365/365	14	77	277	405
	1.1	90L	-	•	•	•	•	6/6As	90	730/850	100	530/650	400/400	365/365	14	77	277	405
100-200	1.1	90L	-	•	•	•	•	7/7s	90	840/976	100	640/776	400/400	365/365	14	77	277	405
	1.5	100L	-	•	•	•	•	11/11s	90	900/1036	100	700/836	416/416	373/373	19	114	314	449
	2.2	112M	-	•	•	•	•	16/16s	90	900/1036	100	700/836	446/446	403/403	19	114	314	462
100-250	3	132M	-	•	•	•	•	21/21s	90	980/1116	100	780/916	447/447	404/404	19	114	314	481
	2.2	112M	-	•	•	•	•	17/17s	90	930/1030	100	730/830	456/456	413/413	19	114	339	487
	3	132M	-	•	•	•	•	22/22s	90	1010/1080	100	810/880	446/446	403/403	19	114	339	506
100-315	4	132M	-	•	•	•	•	22/22s	90	1010/1080	100	810/880	446/446	403/403	19	114	339	506
	5.5	132M	-	•	•	•	•	22/22s	90	1010/1080	100	810/880	446/446	403/403	19	114	339	506
	4	132M	-	•	•	•	•	22/22s	90	1010/1080	100	810/880	446/446	403/403	19	114	364	531
100-400	5.5	132M	-	•	•	•	•	22/22s	90	1010/1080	100	810/880	446/446	403/403	19	114	364	531
	7.5	160M	-	•	•	•	•	28/28s	90	1140/1250	100	940/1050	446/446	403/403	19	114	364	561
	11	160L	-	•	•	•	•	28/28s	90	1140/1250	100	940/1050	446/446	403/403	19	114	364	561
125-200	7.5	160M	-	•	•	•	•	29/29s	110	1160/1336	100	960/1136	586/586	543/543	19	116	396	593
	11	160L	-	•	•	•	•	29/29s	110	1160/1336	100	960/1136	586/586	543/543	19	116	396	593
	15	180L	-	•	•	•	•	36/36s	110	1200/1370	100	1000/1170	610/610	558/558	24	160	440	698
125-250	1.5	100L	-	•	•	•	•	12/12s	90	920/1030	100	720/830	446/446	403/403	19	114	364	499
	2.2	112M	-	•	•	•	•	17/17s	90	930/1030	100	730/830	456/456	413/413	19	114	364	512
	3	132M	-	•	•	•	•	22/22s	90	1010/1080	100	810/880	446/446	403/403	19	114	364	531
125-315	4	132M	-	•	•	•	•	22/22s	90	1010/1080	100	810/880	446/446	403/403	19	114	364	531
	3	132M	-	•	•	•	•	22/22s	90	1010/1080	100	810/880	446/446	403/403	19	114	364	531
	4	132M	-	•	•	•	•	22/22s	90	1010/1080	100	810/880	446/446	403/403	19	114	364	531
125-400	5.5	132M	-	•	•	•	•	22/22s	90	1010/1080	100	810/880	446/446	403/403	19	114	364	531
	7.5	160M	-	•	•	•	•	28/28s	90	1140/1250	100	940/1050	446/446	403/403	19	114	364	561
	5.5	132M	-	•	•	•	•	23/23s	110	1030/1180	100	830/980	591/591	548/548	19	116	396	563
125-500	7.5	160M	-	•	•	•	•	29/29s	110	1160/1336	100	960/1136	586/586	543/543	19	116	396	593
	11	160L	-	•	•	•	•	29/29s	110	1160/1336	100	960/1136	586/586	543/543	19	116	396	593
	15	180L	-	•	•	•	•	36/36s	110	1200/1370	100	1000/1170	610/610	558/558	24	160	440	698
150-200	11	160L	-	•	•	•	•	30/30s	110	1156/1292	100	956/1092	596/596	553/553	19	116	431	628
	15	180L	-	•	•	•	•	37/37s	110	1200/1336	100	1000/1136	620/620	568/568	24	156	471	729
	18.5	200L	-	•	•	•	•	44/44s	110	1240/1376	100	1040/1176	610/610	558/558	24	156	471	776
150-250	22	200L	-	•	•	•	•	44/44s	110	1240/1376	100	1040/1176	610/610	558/558	24	156	471	776
	30	225M	-	•	•	•	•	54/54s	110	1305/1440	100	1105/1240	610/610	558/558	24	160	475	800
	18.5	200L	-	•	•	•	•	46/46s	110	1400/1576	100	1200/1376	660/660	608/608	24	156	556	861
150-315.2	22	200L	-	•	•	•	•	46/46s	110	1400/1576	100	1200/1376	660/660	608/608	24	156	556	861
	30	225M	-	•	•	•	•	49/49s	110	1460/1636	100	1260/1436	660/660	608/608	24	156	556	881
	37	250M	-	•	•	•	•	57/57s	110	1530/1706	100	1330/1506	680/680	619/619	28	196	596	988
150-315	45	280S	-	•	•	•	•	65/65s	110	1660/1836	100	1460/1636	690/690	629/629	28	196	596	1028
	55	280M	-	•	•	•	•	65/65s	110	1660/1836	100	1460/1636	690/690	629/629	28	196	596	1028
	2.2	112M	-	•	•	•	•	18/18s	110	920/1096	100	720/896	596/596	553/553	19	116	396	544
150-400	3	132M	-	•	•	•	•	23/23s	110	1030/1180	100	830/980	591/591	548/548	19	116	396	563
	4	132M	-	•	•	•	•	23/23s	110	1030/1180	100	830/980	591/591	548/548	19	116	396	563
	5.5	132M	-	•	•	•	•	23/23s	110	1030/1180	100	830/980	591/591	548/548	19	116	396	563
150-400	7.5	160M	-	•	•	•	•	29/29s	110	1160/1336	100	960/1136	586/586	543/543	19	116	396	593
	11	160L	-	•	•	•	•	29/29s	110	1160/1336	100	960/1136	586/586	543/543	19	116	396	593
	7.5	160M	-	•	•	•	•	29/29s	110	1160/1336	100	960/1136	586/586	543/543	19	116	396	593
150-400	11	160L	-	•	•	•	•	29/29s	110	1160/1336	100	960/1136	586/586	543/543	19	116	396	593
	15	180L	-	•	•	•	•	36/36s	110	1200/1370	100	1000/1170	610/610	558/558	24	160	440	698
	18.5	200L	-	•	•	•	•	43/43s	110	1240/1420	100	1040/1220	610/610	558/558	24	156	436	741
150-400	11	160L	-	•	•	•	•	29/29s	110	1160/1336	100	960/1136	586/586	543/543	19	116	396	593
	15	180L	-	•	•	•	•	36/36s	110	1200/1370	100	1000/1170	610/610	558/558	24	160	440	698
	18.5	200L	-	•	•	•	•	43/43s	110	1240/1420	100	1040/1220	610/610	558/558	24	156	436	741
150-400	22	200L	-	•	•	•	•	43/43s	110	1240/1420	100	1040/1220	610/610	558/558	24	156	436	741
	30	225M	-	•	•	•	•	53/53s	110	1310/1486	100	1110/1286	610/610	558/558	24	160	440	765
	18.5	200L	-	•	•	•	•	44/44s	110	1240/1376	100	1040/1176	610/610	558/558	24	156	471	776
150-400	22	200L	-	•	•	•	•	44/44s	110	1240/1376	100	1040/1176	610/610	558/558	24	156	471	776
	30	225M	-	•	•	•	•	54/54s	110	1305/1440	100	1105/1240	610/610	558/558	24	160	475	800
	37	250M	-	•	•	•	•	62/62s	110	1370/1506	100	1170/1306	630/630	569/569	28	196	511	903
	45	280S	-	•	•	•	•	67/67s	110	1520/1656	100	1320/1456	660/660	599/599	28	196	511	943

Pump type	Motor data					Dimensions [mm]								Pump with E-motor ³				
	P2 [kW]	Frame size	Make				Base frame No ¹	a2	l1 ¹	l2	l3 ¹	b2 ¹	b3 ¹		d	h	h3	h4 ²
			MG	Siemens	MMG-E	MMG-G												
150-500	37	250M	-	•	•	•	•	57/57s	110	1530/1706	100	1330/1506	680/680	619/619	28	196	596	988
	45	280S	-	•	•	•	•	65/65s	110	1660/1836	100	1460/1636	690/690	629/629	28	196	596	1028
	55	280M	-	•	•	•	•	65/65s	110	1660/1836	100	1460/1636	690/690	629/629	28	196	596	1028
	75	315S	-	•	•	•	•	79/79s	110	1700/1876	100	1500/1676	690/690	629/629	28	196	596	1091
200-400	15	180L	-	•	•	•	•	39/39s	110	1365/1541	100	1165/1341	670/670	618/618	24	156	556	814
	18.5	200L	-	•	•	•	•	46/46s	110	1400/1576	100	1200/1376	660/660	608/608	24	156	556	861
	22	200L	-	•	•	•	•	46/46s	110	1400/1576	100	1200/1376	660/660	608/608	24	156	556	861
	30	225M	-	•	•	•	•	49/49s	110	1460/1636	100	1260/1436	660/660	608/608	24	156	556	881
200-450	37	250M	-	•	•	•	•	57/57s	110	1530/1706	100	1330/1506	680/680	619/619	28	196	596	988
	18.5	200L	-	•	•	•	•	46/46s	110	1400/1576	100	1200/1376	660/660	608/608	24	156	556	861
	22	200L	-	•	•	•	•	46/46s	110	1400/1576	100	1200/1376	660/660	608/608	24	156	556	861
	30	225M	-	•	•	•	•	49/49s	110	1460/1636	100	1260/1436	660/660	608/608	24	156	556	881
250-350	37	250M	-	•	•	•	•	57/57s	110	1530/1706	100	1330/1506	680/680	619/619	28	196	596	988
	45	280S	-	•	•	•	•	65/65s	110	1660/1836	100	1460/1636	690/690	629/629	28	196	596	1028
	11	160L	-	•	•	•	•	26/26s	110	1350/1526	100	1150/1326	636/636	593/593	19	116	566	763
	15	180L	-	•	•	•	•	40/40s	110	1403/1579	100	1203/1379	660/660	610/610	24	156	606	864
250-400	18.5	200L	-	•	•	•	•	47/47s	110	1438/1614	100	1238/1414	660/660	608/608	24	156	606	911
	22	200L	-	•	•	•	•	47/47s	110	1438/1614	100	1238/1414	660/660	608/608	24	156	606	911
	15	180L	-	•	•	•	•	40/40s	110	1403/1579	100	1203/1379	660/660	610/610	24	156	606	864
	18.5	200L	-	•	•	•	•	47/47s	110	1438/1614	100	1238/1414	660/660	608/608	24	156	606	911
250-450	22	200L	-	•	•	•	•	47/47s	110	1438/1614	100	1238/1414	660/660	608/608	24	156	606	911
	30	225M	-	•	•	•	•	50/50s	110	1504/1680	100	1304/1480	660/660	608/608	24	156	606	931
	37	250M	-	•	•	•	•	58/58s	110	1568/1744	100	1368/1544	780/780	719/719	28	196	646	1038
	45	280S	-	•	•	•	•	66/66s	110	1700/1876	100	1500/1676	780/780	719/719	28	196	646	1078
250-500	18.5	200L	-	•	•	•	•	47/47s	110	1438/1614	100	1238/1414	660/660	608/608	24	156	606	911
	22	200L	-	•	•	•	•	47/47s	110	1438/1614	100	1238/1414	660/660	608/608	24	156	606	911
	30	225M	-	•	•	•	•	50/50s	110	1504/1680	100	1304/1480	660/660	608/608	24	156	606	931
	37	250M	-	•	•	•	•	58/58s	110	1568/1744	100	1368/1544	780/780	719/719	28	196	646	1038
250-500	45	280S	-	•	•	•	•	66/66s	110	1700/1876	100	1500/1676	780/780	719/719	28	196	646	1078
	55	280M	-	•	•	•	•	66/66s	110	1700/1876	100	1500/1676	780/780	719/719	28	196	646	1078
	45	280S	-	•	•	•	•	66/66s	110	1700/1876	100	1500/1676	780/780	719/719	28	196	646	1078
	55	280M	-	•	•	•	•	66/66s	110	1700/1876	100	1500/1676	780/780	719/719	28	196	646	1078
250-500	75	315S	-	•	•	•	•	78/78s	110	1710/1886	100	1510/1686	780/780	719/719	28	196	646	1141
	90	315M	-	•	•	•	•	83/83s	110	1900/2076	100	1700/1875	780/780	719/719	28	196	646	1141

¹ Pump with standard coupling or pump with spacer coupling.

² Pump with Siemens motor.

³ For pump dimensions with E-motors, see the relevant pages in section [17. Dimensional drawings and technical data](#).

NB base frames

Some NB pumps are available with base frame as an option. The pump is mounted on the base frame when produced, and therefore the base frame should be ordered together with the pump.

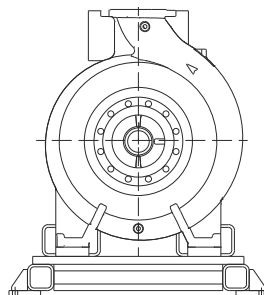
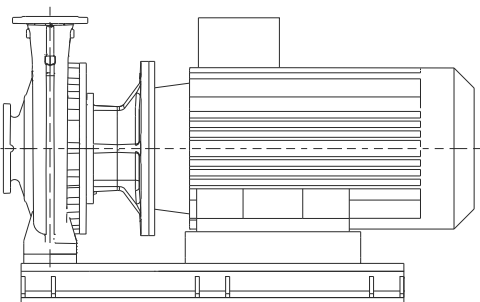

Fig. 88 NB pump with base frame

TM05 1514 2711

NB base frames, dimensional sketches

Base frame number	Dimensions [mm]
13 (IEC 225/250)	<p>TM04 0486 0708</p>
14 (IEC 280)	<p>TM04 0485 0708</p>
15 (IEC 315)	<p>TM04 0484 0708</p>

Base frame number	Dimensions [mm]
10K	<p>TM04 9284 3810</p>
10L	<p>TM04 9285 3810</p>
10M	<p>TM04 9286 3810</p>

NB pump dimensions as per motor type

NB, 2-pole

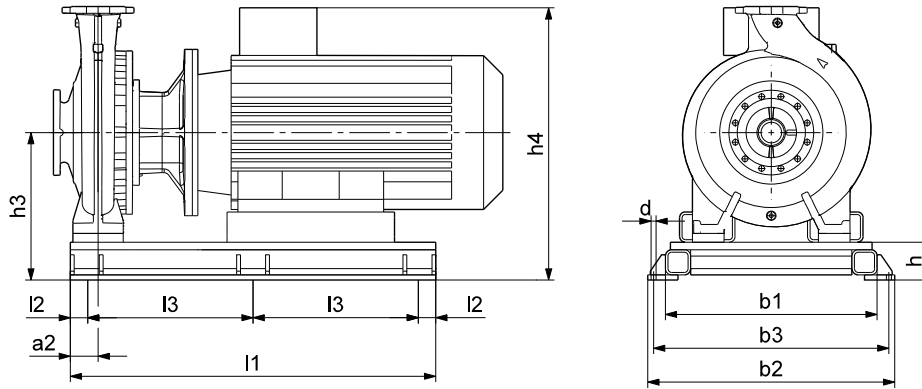

TM04 0482 0808

Pump type	P2 [kW]	Motor frame size	Motor	Base frame number	Dimensions [mm]										Weight [kg] Base frame incl. support blocks	
					l1	l2	l3	b1	b2	b3	h	h3	h4	a2		d
40-315	45	225M	Siemens	13	1200	60	540	730	860	790	110	345	670	75	28	263
	45	225	MMG-E	13	1200	60	540	730	860	790	110	345	665	75	28	263
	45	225M	MMG-G	13	1200	60	540	730	860	790	110	345	772	75	28	263
50-315	45	225M	Siemens	13	1200	60	540	730	860	790	110	345	670	75	28	259
	45	225	MMG-E	13	1200	60	540	730	860	790	110	345	665	75	28	259
	45	225M	MMG-G	13	1200	60	540	730	860	790	110	345	772	75	28	259
	55	250M	Siemens	13	1200	60	540	730	860	790	110	395	787	75	28	293
	55	250	MMG-E	13	1200	60	540	730	860	790	110	395	754	75	28	293
	55	250S	MMG-G	13	1200	60	540	730	860	790	110	395	888	75	28	293
65-250	45	225M	Siemens	13	1200	60	540	730	860	790	110	345	670	90	28	265
	45	225	MMG-E	13	1200	60	540	730	860	790	110	345	665	90	28	265
	45	225M	MMG-G	13	1200	60	540	730	860	790	110	345	772	90	28	265
	55	250M	Siemens	13	1200	60	540	730	860	790	110	410	802	90	28	343
	55	250	MMG-E	13	1200	60	540	730	860	790	110	410	769	90	28	343
	55	250S	MMG-G	13	1200	60	540	730	860	790	110	410	903	90	28	343
	75	280S	Siemens	14	1300	65	585	670	810	730	130	430	862	90	28	359
	75	280	MMG-E	14	1300	65	585	670	810	730	130	430	816	90	28	359
	75	250M	MMG-G	13	1200	60	540	730	860	790	110	410	903	90	28	308
	55	250M	Siemens	13	1200	60	540	730	860	790	110	395	787	90	28	296
65-315	55	250	MMG-E	13	1200	60	540	730	860	790	110	395	754	90	28	296
	55	250S	MMG-G	13	1200	60	540	730	860	790	110	395	888	90	28	296
	75	280S	Siemens	14	1300	65	585	670	810	730	130	415	847	90	28	318
	75	280	MMG-E	14	1300	65	585	670	810	730	130	415	801	90	28	318
	75	250M	MMG-G	13	1200	60	540	730	860	790	110	395	888	90	28	267
	90	280M	Siemens	14	1300	65	585	670	810	730	130	415	847	90	28	319
	90	280	MMG-E	14	1300	65	585	670	810	730	130	415	801	90	28	319
	90	280S	MMG-G	14	1300	65	585	670	810	730	130	415	938	90	28	319
	110	280M	MMG-G	14	1300	65	585	670	810	730	130	475	998	90	28	384
	110	315S	Siemens	15	1450	65	660	840	980	920	150	495	990	90	28	454
80-200	110	315	MMG-E	15	1450	65	660	840	980	920	150	495	966	90	28	454
	45	225M	Siemens	13	1200	60	540	730	860	790	110	350	675	75	28	270
	45	225	MMG-E	13	1200	60	540	730	860	790	110	350	670	75	28	270
	45	225M	MMG-G	13	1200	60	540	730	860	790	110	350	777	75	28	270
	55	250M	Siemens	13	1200	60	540	730	860	790	110	390	782	75	28	309
	55	250	MMG-E	13	1200	60	540	730	860	790	110	390	749	75	28	309
	55	250S	MMG-G	13	1200	60	540	730	860	790	110	390	883	75	28	309
80-250	45	225M	Siemens	13	1200	60	540	730	860	790	110	345	670	90	28	265
	45	225	MMG-E	13	1200	60	540	730	860	790	110	345	665	90	28	265
	45	225M	MMG-G	13	1200	60	540	730	860	790	110	345	772	90	28	265
	55	250M	Siemens	13	1200	60	540	730	860	790	110	410	802	90	28	343
	55	250	MMG-E	13	1200	60	540	730	860	790	110	410	769	90	28	343
	55	250S	MMG-G	13	1200	60	540	730	860	790	110	410	903	90	28	343
	75	280S	Siemens	14	1300	65	585	670	810	730	130	430	862	90	28	359
	75	280	MMG-E	14	1300	65	585	670	810	730	130	430	816	90	28	359
	75	250M	MMG-G	13	1200	60	540	730	860	790	110	410	903	90	28	308
	90	280M	Siemens	14	1300	65	585	670	810	730	130	430	862	90	28	361
90	280	MMG-E	14	1300	65	585	670	810	730	130	430	816	90	28	361	
90	280S	MMG-G	14	1300	65	585	670	810	730	130	430	953	90	28	361	

Pump type	P2 [kW]	Motor frame size	Motor	Base frame number	Dimensions [mm]										Weight [kg] Base frame incl. support blocks		
					l1	l2	l3	b1	b2	b3	h	h3	h4	a2		d	
80-315	90	280M	Siemens	14	1300	65	585	670	810	730	130	415	847	90	28	314	
	90	280	MMG-E	14	1300	65	585	670	810	730	130	415	801	90	28	314	
	90	280S	MMG-G	14	1300	65	585	670	810	730	130	415	938	90	28	314	
	110	315S	Siemens	15	1450	65	660	840	980	920	150	500	995	90	28	458	
	110	315	MMG-E	15	1450	65	660	840	980	920	150	500	971	90	28	458	
	110	280M	MMG-G	14	1300	65	585	670	810	730	130	480	1003	90	28	388	
	132	315M	Siemens	15	1450	65	660	840	980	920	150	500	995	90	28	462	
	132	315	MMG-E	15	1450	65	660	840	980	920	150	500	971	90	28	462	
	132	315S	MMG-G	15	1450	65	660	840	980	920	150	500	1048	90	28	462	
	160	315L	Siemens	15	1450	65	660	840	980	920	150	500	995	90	28	466	
	160	315	MMG-E	15	1450	65	660	840	980	920	150	500	971	90	28	466	
	160	315M	MMG-G	15	1450	65	660	840	980	920	150	500	1048	90	28	466	
	100-200	45	225M	Siemens	13	1200	60	540	730	860	790	110	345	670	90	28	265
		45	225	MMG-E	13	1200	60	540	730	860	790	110	345	665	90	28	265
		45	225M	MMG-G	13	1200	60	540	730	860	790	110	345	772	90	28	265
55		250M	Siemens	13	1200	60	540	730	860	790	110	410	802	90	28	343	
55		250	MMG-E	13	1200	60	540	730	860	790	110	410	769	90	28	343	
55		250S	MMG-G	13	1200	60	540	730	860	790	110	410	903	90	28	343	
75		280S	Siemens	14	1300	65	585	670	810	730	130	430	862	90	28	359	
75		280	MMG-E	14	1300	65	585	670	810	730	130	430	816	90	28	359	
75		250M	MMG-G	13	1200	60	540	730	860	790	110	410	903	90	28	308	
55		250M	Siemens	13	1200	60	540	730	860	790	110	395	787	90	28	296	
100-250	55	250	MMG-E	13	1200	60	540	730	860	790	110	395	754	90	28	296	
	55	250S	MMG-G	13	1200	60	540	730	860	790	110	395	888	90	28	296	
	75	280S	Siemens	14	1300	65	585	670	810	730	130	415	847	90	28	318	
	75	280	MMG-E	14	1300	65	585	670	810	730	130	415	801	90	28	318	
	75	250M	MMG-G	13	1200	60	540	730	860	790	110	395	888	90	28	267	
	90	280M	Siemens	14	1300	65	585	670	810	730	130	415	847	90	28	319	
	90	280	MMG-E	14	1300	65	585	670	810	730	130	415	801	90	28	319	
	90	280S	MMG-G	14	1300	65	585	670	810	730	130	415	938	90	28	319	
	110	315S	Siemens	15	1450	65	660	840	980	920	150	495	990	90	28	454	
	110	315	MMG-E	15	1450	65	660	840	980	920	150	495	966	90	28	454	
	110	280M	MMG-G	14	1300	65	585	670	810	730	130	475	998	90	28	384	
	132	315M	Siemens	15	1450	65	660	840	980	920	150	495	990	90	28	458	
	132	315	MMG-E	15	1450	65	660	840	980	920	150	495	966	90	28	458	
	132	315S	MMG-G	15	1450	65	660	840	980	920	150	495	1043	90	28	458	
	100-315	110	315S	Siemens	15	1450	65	660	840	980	920	150	500	995	90	28	458
110		315	MMG-E	15	1450	65	660	840	980	920	150	500	971	90	28	458	
110		280M	MMG-G	14	1300	65	585	670	810	730	130	480	1003	90	28	388	
132		315M	Siemens	15	1450	65	660	840	980	920	150	500	995	90	28	462	
132		315	MMG-E	15	1450	65	660	840	980	920	150	500	971	90	28	462	
132		315S	MMG-G	15	1450	65	660	840	980	920	150	500	1048	90	28	462	
160		315L	Siemens	15	1450	65	660	840	980	920	150	500	995	90	28	466	
160		315	MMG-E	15	1450	65	660	840	980	920	150	500	971	90	28	466	
160		315M	MMG-G	15	1450	65	660	840	980	920	150	500	1048	90	28	466	
200		315L	Siemens	15	1450	65	660	840	980	920	150	500	995	90	28	466	
200		315	MMG-E	15	1450	65	660	840	980	920	150	500	1024	90	28	466	
200		315M	MMG-G	15	1450	65	660	840	980	920	150	500	995	90	28	466	
125-200		45	225M	Siemens	13	1200	60	540	730	860	790	110	360	685	90	28	269
		45	225	MMG-E	13	1200	60	540	730	860	790	110	360	680	90	28	269
		45	225M	MMG-G	13	1200	60	540	730	860	790	110	360	787	90	28	269
	55	250M	Siemens	13	1200	60	540	730	860	790	110	395	787	90	28	291	
	55	250	MMG-E	13	1200	60	540	730	860	790	110	395	754	90	28	291	
	55	250S	MMG-G	13	1200	60	540	730	860	790	110	395	888	90	28	291	
	75	280S	Siemens	14	1300	65	585	670	810	730	130	415	847	90	28	314	
	75	280	MMG-E	14	1300	65	585	670	810	730	130	415	801	90	28	314	
	75	250M	MMG-G	13	1200	60	540	730	860	790	110	395	888	90	28	263	
	90	280M	Siemens	14	1300	65	585	670	810	730	130	415	847	90	28	314	
	90	280	MMG-E	14	1300	65	585	670	810	730	130	415	801	90	28	314	
	90	280S	MMG-G	14	1300	65	585	670	810	730	130	415	938	90	28	314	
	110	315S	Siemens	15	1450	65	660	840	980	920	150	500	995	90	28	458	
	110	315	MMG-E	15	1450	65	660	840	980	920	150	500	971	90	28	458	
	110	280M	MMG-G	14	1300	65	585	670	810	730	130	480	1003	90	28	388	

Pump type	P2 [kW]	Motor frame size	Motor	Base frame number	Dimensions [mm]										Weight [kg] Base frame incl. support blocks	
					l1	l2	l3	b1	b2	b3	h	h3	h4	a2		d
125-250	90	280M	Siemens	14	1300	65	585	670	810	730	130	415	847	90	28	314
	90	280	MMG-E	14	1300	65	585	670	810	730	130	415	801	90	28	314
	90	280S	MMG-G	14	1300	65	585	670	810	730	130	415	938	90	28	314
	110	315S	Siemens	15	1450	65	660	840	980	920	150	500	995	90	28	458
	110	315	MMG-E	15	1450	65	660	840	980	920	150	500	971	90	28	458
	110	280M	MMG-G	14	1300	65	585	670	810	730	130	480	1003	90	28	388
	132	315M	Siemens	15	1450	65	660	840	980	920	150	500	995	90	28	462
	132	315	MMG-E	15	1450	65	660	840	980	920	150	500	971	90	28	462
	132	315S	MMG-G	15	1450	65	660	840	980	920	150	500	1048	90	28	462
	160	315L	Siemens	15	1450	65	660	840	980	920	150	500	995	90	28	466
	160	315	MMG-E	15	1450	65	660	840	980	920	150	500	971	90	28	466
	160	315M	MMG-G	15	1450	65	660	840	980	920	150	500	1048	90	28	466
	200	315S	Siemens	15	1450	65	660	840	980	920	150	500	995	90	28	466
	200	315	MMG-E	15	1450	65	660	840	980	920	150	500	1024	90	28	466
	200	315M	MMG-G	15	1450	65	660	840	980	920	150	500	995	90	28	466
125-315	132	315M	Siemens	15	1450	65	660	840	980	920	150	490	985	110	28	433
	132	315	MMG-E	15	1450	65	660	840	980	920	150	490	961	110	28	433
	132	315S	MMG-G	15	1450	65	660	840	980	920	150	490	1038	110	28	433
	160	315L	Siemens	15	1450	65	660	840	980	920	150	490	985	110	28	436
	160	315	MMG-E	15	1450	65	660	840	980	920	150	490	961	110	28	436
	160	315M	MMG-G	15	1450	65	660	840	980	920	150	490	1038	110	28	436
	200	315L	Siemens	15	1450	65	660	840	980	920	150	490	985	110	28	436
	200	315	MMG-E	15	1450	65	660	840	980	920	150	490	1014	110	28	436
150-200	200	315M	MMG-G	15	1450	65	660	840	980	920	150	490	985	110	28	436
	75	280S	Siemens	14	1300	65	585	670	810	730	130	410	842	110	28	302
	75	280	MMG-E	14	1300	65	585	670	810	730	130	410	796	110	28	302
	75	250M	MMG-G	13	1200	60	540	730	860	790	110	390	883	110	28	251
	90	280M	Siemens	14	1300	65	585	670	810	730	130	410	842	110	28	302
	90	280	MMG-E	14	1300	65	585	670	810	730	130	410	796	110	28	302
	90	280S	MMG-G	14	1300	65	585	670	810	730	130	410	933	110	28	302
	110	315S	Siemens	15	1450	65	660	840	980	920	150	490	985	110	28	430
150-250	110	315	MMG-E	15	1450	65	660	840	980	920	150	490	961	110	28	430
	110	280M	MMG-G	14	1300	65	585	670	810	730	130	470	993	110	28	360
	132	315M	Siemens	15	1450	65	660	840	980	920	150	490	985	110	28	433
	132	315	MMG-E	15	1450	65	660	840	980	920	150	490	961	110	28	433
	132	315S	MMG-G	15	1450	65	660	840	980	920	150	490	1038	110	28	433
	160	315L	Siemens	15	1450	65	660	840	980	920	150	490	985	110	28	436
	160	315	MMG-E	15	1450	65	660	840	980	920	150	490	961	110	28	436
	160	315M	MMG-G	15	1450	65	660	840	980	920	150	490	1038	110	28	436
	200	315L	Siemens	15	1450	65	660	840	980	920	150	490	985	110	28	436
	200	315	MMG-E	15	1450	65	660	840	980	920	150	490	1014	110	28	436
200	315M	MMG-G	15	1450	65	660	840	980	920	150	490	985	110	28	436	

For pumps with other motor type, information about pump dimensions, weight and base frame number, see Grundfos Product Center.

NB, 4-pole

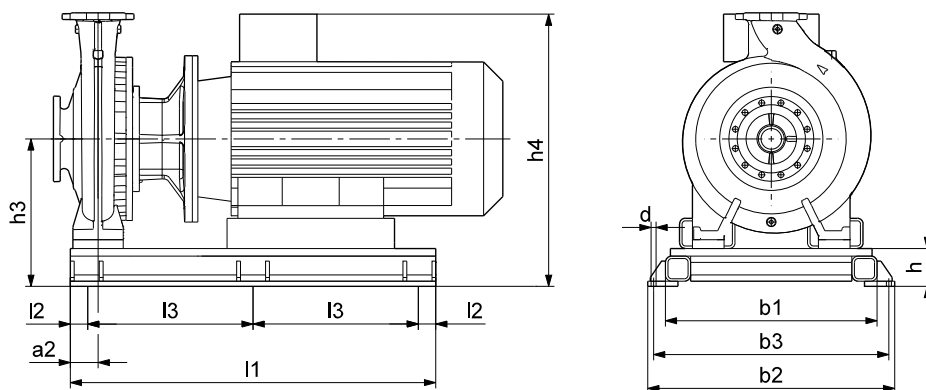

TM04 0482 0808

Pump type	P2 [kW]	Motor frame size	Motor	Base frame number	Dimensions [mm]											Weight [kg] Base frame incl. support blocks
					l1	l2	l3	b1	b2	b3	h	h3	h4	a2	d	
80-400	37	225S	Siemens	13	1200	60	540	730	860	790	110	395	720	90	28	266
	37	225S	MMG-G	13	1200	60	540	730	860	790	110	395	822	90	28	266
	45	225M	Siemens	13	1200	60	540	730	860	790	110	395	720	90	28	267
	45	225M	MMG-E	13	1200	60	540	730	860	790	110	395	715	90	28	267
100-400	45	225M	MMG-G	13	1200	60	540	730	860	790	110	395	822	90	28	267
	37	225S	Siemens	13	1200	60	540	730	860	790	110	395	720	110	28	267
	37	225S	MMG-E	13	1200	60	540	730	860	790	110	395	715	110	28	267
	37	225S	MMG-G	13	1200	60	540	730	860	790	110	395	822	110	28	267
	45	225M	Siemens	13	1200	60	540	730	860	790	110	395	720	110	28	267
	45	225M	MMG-E	13	1200	60	540	730	860	790	110	395	715	110	28	267
125-315	45	225M	MMG-G	13	1200	60	540	730	860	790	110	395	822	110	28	267
	55	250M	Siemens	13	1200	60	540	730	860	790	110	395	787	110	28	286
	55	250M	MMG-E	13	1200	60	540	730	860	790	110	395	754	110	28	286
	55	250S	MMG-G	13	1200	60	540	730	860	790	110	395	888	110	28	286
	37	225S	Siemens	13	1200	60	540	730	860	790	110	395	720	110	28	267
	37	225S	MMG-E	13	1200	60	540	730	860	790	110	395	715	110	28	267
	37	225S	MMG-G	13	1200	60	540	730	860	790	110	390	822	110	28	267
	45	225M	Siemens	13	1200	60	540	730	860	790	110	395	720	110	28	267
	45	225M	MMG-E	13	1200	60	540	730	860	790	110	395	715	110	28	267
	45	225M	MMG-G	13	1200	60	540	730	860	790	110	395	822	110	28	267
125-400	37	225S	Siemens	13	1200	60	540	730	860	790	110	435	760	110	28	280
	37	225S	MMG-E	13	1200	60	540	730	860	790	110	435	755	110	28	280
	37	225S	MMG-G	13	1200	60	540	730	860	790	110	435	862	110	28	280
	45	225M	Siemens	13	1200	60	540	730	860	790	110	435	760	110	28	282
	45	225M	MMG-E	13	1200	60	540	730	860	790	110	435	755	110	28	282
	45	225M	MMG-G	13	1200	60	540	730	860	790	110	435	862	110	28	282
	55	250M	Siemens	13	1200	60	540	730	860	790	110	425	817	110	28	314
	55	250M	MMG-E	13	1200	60	540	730	860	790	110	425	784	110	28	314
	55	250S	MMG-G	13	1200	60	540	730	860	790	110	425	918	110	28	314
	75	280S	Siemens	14	1300	65	585	670	810	730	130	445	877	110	28	337
	75	280S	MMG-E	14	1300	65	585	670	810	730	130	445	831	110	28	337
	75	250M	MMG-G	13	1200	60	540	730	860	790	110	425	918	110	28	286
90	280M	Siemens	14	1300	65	585	670	810	730	130	445	877	110	28	341	
90	280M	MMG-E	14	1300	65	585	670	810	730	130	445	831	110	28	341	
90	280S	MMG-G	14	1300	65	585	670	810	730	130	445	968	110	28	341	

Pump type	P2 [kW]	Motor frame size	Motor	Base frame number	Dimensions [mm]								Weight [kg] Base frame incl. support blocks			
					l1	l2	l3	b1	b2	b3	h	h3		h4	a2	d
125-500	55	250M	Siemens	13	1200	60	540	730	860	790	110	540	932	110	28	311
	55	250M	MMG-E	13	1200	60	540	730	860	790	110	540	899	110	28	311
	55	250S	MMG-G	13	1200	60	540	730	860	790	110	540	1033	110	28	311
	75	280S	Siemens	14	1300	65	585	670	810	730	130	590	1022	110	28	376
	75	280S	MMG-E	14	1300	65	585	670	810	730	130	590	976	110	28	376
	75	250M	MMG-G	13	1200	60	540	730	860	790	110	570	1063	110	28	325
	90	280M	Siemens	14	1300	65	585	670	810	730	130	590	1022	110	28	381
	90	280M	MMG-E	14	1300	65	585	670	810	730	130	590	976	110	28	381
	90	280S	MMG-G	14	1300	65	585	670	810	730	130	590	1113	110	28	381
	110	315S	Siemens	15	1450	65	660	840	980	920	150	585	1080	110	28	439
	110	315S	MMG-E	15	1450	65	660	840	980	920	150	585	1056	110	28	439
	110	280M	MMG-G	14	1300	65	585	670	810	730	130	565	1088	110	28	369
	132	315MA	Siemens	15	1450	65	660	840	980	920	150	585	1080	110	28	444
	132	315MA	MMG-E	15	1450	65	660	840	980	920	150	585	1056	110	28	444
	132	315S	MMG-G	15	1450	65	660	840	980	920	150	585	1133	110	28	444
	160	315MB	Siemens	15	1450	65	660	840	980	920	150	585	1080	110	28	449
	160	315MB	MMG-E	15	1450	65	660	840	980	920	150	585	1056	110	28	449
	160	315M	MMG-G	15	1450	65	660	840	980	920	150	585	1133	110	28	449
150-250	37	225S	Siemens	13	1200	60	540	730	860	790	110	395	720	110	28	267
	37	225S	MMG-E	13	1200	60	540	730	860	790	110	395	715	110	28	267
	37	225S	MMG-G	13	1200	60	540	730	860	790	110	395	822	110	28	267
	45	225M	Siemens	13	1200	60	540	730	860	790	110	395	720	110	28	267
	45	225M	MMG-E	13	1200	60	540	730	860	790	110	395	715	110	28	267
	45	225M	MMG-G	13	1200	60	540	730	860	790	110	395	822	110	28	267
150-315.2	37	225S	Siemens	13	1200	60	540	730	860	790	110	435	760	110	28	280
	37	225S	MMG-E	13	1200	60	540	730	860	790	110	435	755	110	28	280
	37	225S	MMG-G	13	1200	60	540	730	860	790	110	435	862	110	28	280
	45	225M	Siemens	13	1200	60	540	730	860	790	110	435	760	110	28	282
	45	225M	MMG-E	13	1200	60	540	730	860	790	110	435	755	110	28	282
	45	225M	MMG-G	13	1200	60	540	730	860	790	110	435	862	110	28	282
	55	250M	Siemens	13	1200	60	540	730	860	790	110	425	817	110	28	314
	55	250M	MMG-E	13	1200	60	540	730	860	790	110	425	784	110	28	314
	55	250S	MMG-G	13	1200	60	540	730	860	790	110	425	918	110	28	314
	75	280S	Siemens	14	1300	65	585	670	810	730	130	445	877	110	28	337
	75	280S	MMG-E	14	1300	65	585	670	810	730	130	445	831	110	28	337
	75	250M	MMG-G	13	1200	60	540	730	860	790	110	425	918	110	28	286
150-315	37	225S	Siemens	13	1200	60	540	730	860	790	110	435	760	110	28	280
	37	225S	MMG-E	13	1200	60	540	730	860	790	110	435	755	110	28	280
	37	225S	MMG-G	13	1200	60	540	730	860	790	110	435	862	110	28	280
	45	225M	Siemens	13	1200	60	540	730	860	790	110	435	760	110	28	282
	45	225M	MMG-E	13	1200	60	540	730	860	790	110	435	755	110	28	282
	45	225M	MMG-G	13	1200	60	540	730	860	790	110	435	862	110	28	282
	55	250M	Siemens	13	1200	60	540	730	860	790	110	425	817	110	28	314
	55	250M	MMG-E	13	1200	60	540	730	860	790	110	425	784	110	28	314
	55	250S	MMG-G	13	1200	60	540	730	860	790	110	425	918	110	28	314
	75	280S	Siemens	14	1300	65	585	670	810	730	130	445	877	110	28	337
	75	280S	MMG-E	14	1300	65	585	670	810	730	130	445	831	110	28	337
	75	250M	MMG-G	13	1200	60	540	730	860	790	110	425	918	110	28	286
150-400	90	280M	Siemens	14	1300	65	585	670	810	730	130	445	877	110	28	341
	90	280M	MMG-E	14	1300	65	585	670	810	730	130	445	831	110	28	341
	90	280S	MMG-G	14	1300	65	585	670	810	730	130	445	968	110	28	341
	55	250M	Siemens	13	1200	60	540	730	860	790	110	425	817	110	28	314
	55	250M	MMG-E	13	1200	60	540	730	860	790	110	425	784	110	28	314
	55	250S	MMG-G	13	1200	60	540	730	860	790	110	425	918	110	28	314
	75	280S	Siemens	14	1300	65	585	670	810	730	130	445	877	110	28	337
	75	280S	MMG-E	14	1300	65	585	670	810	730	130	445	831	110	28	337
	75	250M	MMG-G	13	1200	60	540	730	860	790	110	425	918	110	28	286
	90	280M	Siemens	14	1300	65	585	670	810	730	130	445	877	110	28	341
	90	280M	MMG-E	14	1300	65	585	670	810	730	130	445	831	110	28	341
	90	280S	MMG-G	14	1300	65	585	670	810	730	130	445	968	110	28	341
110	315S	Siemens	15	1450	65	660	840	980	920	150	490	985	110	28	414	
110	315S	MMG-E	15	1450	65	660	840	980	920	150	490	961	110	28	414	
110	280M	MMG-G	14	1300	65	585	670	810	730	130	470	993	110	28	344	
132	315MA	Siemens	15	1450	65	660	840	980	920	150	490	985	110	28	418	
132	315	MMG-E	15	1450	65	660	840	980	920	150	490	961	110	28	418	
132	315S	MMG-G	15	1450	65	660	840	980	920	150	490	1038	110	28	418	
160	315MB	Siemens	15	1450	65	660	840	980	920	150	490	985	110	28	380	
160	315	MMG-E	15	1450	65	660	840	980	920	150	490	961	110	28	380	
160	315M	MMG-G	15	1450	65	660	840	980	920	150	490	1038	110	28	380	

Pump type	P2 [kW]	Motor frame size	Motor	Base frame number	Dimensions [mm]										Weight [kg] Base frame incl. support blocks	
					l1	l2	l3	b1	b2	b3	h	h3	h4	a2		d
150-500	132	315MA	Siemens	15	1450	65	660	840	980	920	150	585	1080	110	28	444
	132	315	MMG-E	15	1450	65	660	840	980	920	150	585	1056	110	28	444
	132	315S	MMG-G	15	1450	65	660	840	980	920	150	585	1133	110	28	444
	160	315MB	Siemens	15	1450	65	660	840	980	920	150	585	1080	110	28	449
	160	315	MMG-E	15	1450	65	660	840	980	920	150	585	1056	110	28	449
	160	315M	MMG-G	15	1450	65	660	840	980	920	150	585	1133	110	28	449
	200	315L	Siemens	15	1450	65	660	840	980	920	150	585	1080	110	28	444
	200	315L	MMG-E	15	1450	65	660	840	980	920	150	585	1056	110	28	444
	200	315M	MMG-G	15	1450	65	660	840	980	920	150	585	1133	110	28	444

For pumps with other motor type, information about pump dimensions, weight and base frame number, see Grundfos Product Center.

Pump type	P2 [kW]	Siemens		MMG-E		MMG-G		MMG-H	
		Motor frame size	Base frame number	Motor frame size	Base frame number	Motor frame size	Base frame number	Motor frame size	Base frame number
200-400	37	225S	10K	225S	10K	225S	10K	225S	10K
	45	225M	10K	225M	10K	225MC	10K	225M	10K
	55	250M	10L	250M	10L	250SC	10K	250M	10L
	75	280S	10L	280S	10L	250M	10L	280S	10L
	90	280M	10L	280M	10L	280M	10L	280M	10L
	110	315S	10L	315S	10L	280M	10L	315S	10L
	132	315MA	10M	315M	10M	315MA	10M	315LA	10M
	160	315LA	10M	315LA	10M	315MB	10M	315LA	10M
	200	315LA	10M	315LA	10M	315MB	10M	315LA	10M
200-450	75	280S	10L	280S	10L	250MC	10L	280S	10L
	90	280M	10L	280M	10L	280S	10L	280M	10L
	110	315S	10L	315S	10L	280M	10L	315S	10L
	132	315MA	10M	315M	10M	315S	10L	315LA	10M
	160	315LA	10M	315LA	10M	315MB	10M	315LA	10M
	200	315MA	10M	315LA	10M	315MA	10M	315LA	10M
250-350	37	225S	10K	225S	10K	225S	10K	225S	10K
	45	225M	10K	225M	10K	225MC	10K	225M	10K
	55	250M	10L	250M	10L	250SC	10K	250M	10L
	75	280S	10L	280S	10L	250M	10L	280S	10L
	90	280M	10L	280M	10L	280S	10L	280M	10L
	110	315S	10L	315S	10L	280M	10L	315S	10L
	132	315MA	10M	315M	10M	315S	10L	315MA	10M
250-400	45	225M	10K	225M	10K	225MC	10K	225M	10K
	55	250M	10L	250M	10L	250SC	10K	250M	10L
	75	280S	10L	280S	10L	250M	10L	280S	10L
	90	280M	10L	280M	10L	280S	10L	280M	10L
	110	315S	10L	315S	10L	280M	10L	315S	10L
	132	315MA	10M	315M	10M	315S	10L	315MA	10M
	160	315LA	10M	315LA	10M	315MB	10M	315LA	10M
	200	315MB	10M	315LA	10M	315MB	10M	315LA	10M
250-450	75	280S	10L	280S	10L	250MC	10L	280S	10L
	90	280M	10L	280M	10L	280S	10L	280M	10L
	110	315S	10L	315S	10L	280M	10L	315S	10L
	132	315MA	10M	315M	10M	315S	10L	315LA	10M
	160	315LA	10M	315LA	10M	315MB	10M	315LA	10M
250-500	160	315L	10M	315L	10M	315MB	10M	315L	10M
	200	315MB	10M	315L	10M	315MB	10M	315L	10M

For information about pump dimensions and weight, see Grundfos Product Center.

NB, 6-pole

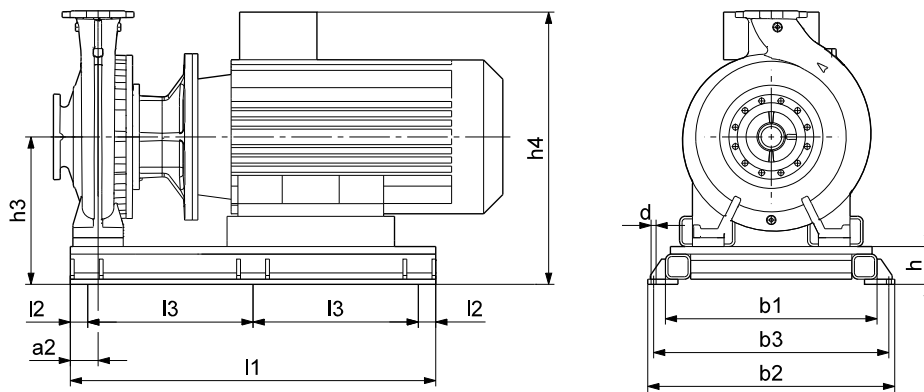

TM04 0482 0808

Pump type	P2 [kW]	Motor frame size	Motor	Base frame number	Dimensions [mm]										Weight [kg] Base frame incl. support blocks		
					l1	l2	l3	b1	b2	b3	h	h3	h4	a2		d	
125-400	30	225M	Siemens	13	1200	60	540	730	860	790	110	435	760	110	28	282	
	30	225M	MMG-G	13	1200	60	540	730	860	790	110	435	862	110	28	282	
	30	225M	Siemens	13	1200	60	540	730	860	790	110	515	840	110	28	295	
	30	225M	MMG-E	13	1200	60	540	730	860	790	110	515	835	110	28	295	
	30	225M	MMG-G	13	1200	60	540	730	860	790	110	515	942	110	28	295	
	37	250M	Siemens	13	1200	60	540	730	860	790	110	540	932	110	28	311	
125-500	37	250M	MMG-E	13	1200	60	540	730	860	790	110	540	899	110	28	311	
	37	250S	MMG-G	13	1200	60	540	730	860	790	110	540	1033	110	28	311	
	45	280S	Siemens	14	1300	65	585	670	810	730	130	530	962	110	28	350	
	45	280S	MMG-E	14	1300	65	585	670	810	730	130	530	916	110	28	350	
	45	250M	MMG-G	13	1200	60	540	730	860	790	110	510	1003	110	28	299	
	55	280M	Siemens	14	1300	65	585	670	810	730	130	530	962	110	28	355	
	55	280M	MMG-E	14	1300	65	585	670	810	730	130	530	916	110	28	355	
	55	280S	MMG-G	14	1300	65	585	670	810	730	130	530	1053	110	28	355	
	150-315	30	225M	Siemens	13	1200	60	540	730	860	790	110	435	760	110	28	282
		30	225M	MMG-E	13	1200	60	540	730	860	790	110	435	755	110	28	282
30		225M	MMG-G	13	1200	60	540	730	860	790	110	435	862	110	28	282	
30		225M	Siemens	13	1200	60	540	730	860	790	110	435	760	110	28	282	
30		225M	MMG-E	13	1200	60	540	730	860	790	110	435	755	110	28	282	
30		225M	MMG-G	13	1200	60	540	730	860	790	110	435	862	110	28	282	
150-400	37	250M	Siemens	13	1200	60	540	730	860	790	110	425	817	110	28	314	
	37	250M	MMG-E	13	1200	60	540	730	860	790	110	425	784	110	28	314	
	37	250S	MMG-G	13	1200	60	540	730	860	790	110	425	918	110	28	314	
	45	280S	Siemens	14	1300	65	585	670	810	730	130	445	877	110	28	337	
	45	280S	MMG-E	14	1300	65	585	670	810	730	130	445	831	110	28	337	
	45	250M	MMG-G	13	1200	60	540	730	860	790	110	425	918	110	28	286	
	37	250M	Siemens	13	1200	60	540	730	860	790	110	540	932	110	28	311	
	37	250M	MMG-E	13	1200	60	540	730	860	790	110	540	899	110	28	311	
150-500	37	250S	MMG-G	13	1200	60	540	730	860	790	110	540	1033	110	28	311	
	45	280S	MMG-E	14	1300	65	585	670	810	730	130	530	916	110	28	350	
	45	250M	MMG-G	13	1200	60	540	730	860	790	110	510	1003	110	28	299	
	55	280M	Siemens	14	1300	65	585	670	810	730	130	530	962	110	28	355	
	55	280M	MMG-E	14	1300	65	585	670	810	730	130	530	916	110	28	355	
	55	280S	MMG-G	14	1300	65	585	670	810	730	130	530	1053	110	28	355	
	75	315S	Siemens	15	1450	65	660	840	980	920	150	585	1080	110	28	439	
	75	315S	MMG-E	15	1450	65	660	840	980	920	150	585	1056	110	28	439	
	75	280M	MMG-G	14	1300	65	585	670	810	730	130	565	1088	110	28	369	

For pumps with other motor type, information about pump dimensions, weight and base frame number, see Grundfos Product Center.

Pump type	P2 [kW]	Siemens		MMG-E		MMG-G		MMG-H	
		Motor frame size	Base frame number	Motor frame size	Base frame number	Motor frame size	Base frame number	Motor frame size	Base frame number
200-400	15	180L	10K	180L	10K	180LC	10K	180L	10K
	18.5	200L	10K	200L	10K	200L	10K	200L	10K
	22	200L	10K	200L	10K	200L	10K	200L	10K
	30	225M	10K	225M	10K	225MC	10K	225M	10K
	37	250M	10L	250M	10L	250SC	10K	250M	10L
	45	280S	10L	280S	10L	250M	10L	280S	10L
	55	280M	10L	280M	10L	280S	10L	280M	10L
200-450	18.5	200L	10K	200L	10K	200L	10K	200L	10K
	22	200L	10K	200L	10K	200L	10K	200L	10K
	30	225M	10K	225M	10K	225MC	10K	225M	10K
	37	250MC	10L	250MC	10L	250SC	10K	250MC	10L
	45	280S	10L	280S	10L	250MC	10L	280S	10L
	55	280M	10L	280M	10L	280S	10L	280M	10L
	75	315S	10L	315S	10L	280M	10L	315S	10L
90	315MA	10M	315MA	10M	315S	10L	315MA	10M	
250-350	11	160L	10K	160L	10K	160L	10K	160L	10K
	15	180L	10K	180L	10K	180LC	10K	180L	10K
	18.5	200L	10K	200L	10K	200L	10K	200L	10K
	22	200L	10K	200L	10K	200L	10K	200L	10K
	30	225M	10K	225M	10K	225M	10K	225M	10K
	37	250M	10L	250M	10L	250SC	10K	250M	10L
	45	280S	10L	280S	10L	250M	10L	280S	10L
250-400	15	180L	10K	180L	10K	180LC	10K	180L	10K
	18.5	200L	10K	200L	10K	200L	10K	200L	10K
	22	200L	10K	200L	10K	200L	10K	200L	10K
	30	225M	10K	225M	10K	225M	10K	225M	10K
	37	250M	10L	250M	10L	225M	10K	250M	10L
	45	280S	10L	280S	10L	250M	10L	280S	10L
	55	280M	10L	280M	10L	280S	10L	280M	10L
75	315S	10L	315S	10L	280M	10L	315S	10L	
90	315MA	10M	315MA	10M	315S	10L	315MA	10M	
250-450	18.5	200L	10K	200L	10K	200L	10K	200L	10K
	22	200L	10K	200L	10K	200L	10K	200L	10K
	30	225M	10K	225M	10K	225MC	10K	225M	10K
	37	250M	10L	250M	10L	250SC	10K	250M	10L
	45	280S	10L	280S	10L	250MC	10L	280S	10L
	55	280M	10L	280M	10L	280S	10L	280M	10L
	75	315S	10L	315S	10L	280M	10L	315S	10L
90	315MA	10M	315MA	10M	315S	10L	315LA	10M	
110	315LA	10M	315LA	10M	315MB	10M	315LA	10M	
250-500	45	280S	10L	280S	10L	250MC	10L	280S	10L
	55	280M	10L	280M	10L	280S	10L	280M	10L
	75	315S	10L	315S	10L	280M	10L	315S	10L
	90	315M	10M	315M	10M	315S	10L	315M	10M
	110	315L	10M	315L	10M	315M	10M	315L	10M
	132	315M	10M	315L	10M	315M	10M	315L	10M
	160	315L	10M	-	-	-	-	-	-

For information about pump dimensions and weight, see Grundfos Product Center.

NB base frames, product numbers

When you order a separate base frame, you will receive the components needed for mounting the pump on the base frame such as:

- base frame
- eye bolts for lifting
- support blocks or support rail
- instructions
- nuts and bolts for securing the pump on the base frame.

NB, 2-pole, 50 Hz

Pump type	P2 [kW]	Product number			
		Base frame			
		Siemens	MMG-E	MMG-G	MMG-H
40-315	45	95921801	95921802	95921801	95921801
50-315	45	95921803	95921804	95921803	95921803
50-315	55	95921813	95921813	95921814	95921813
65-250	45	95921805	95921806	95921805	95921805
65-250	55	95921815	95921815	95921816	95921815
65-250	75	95921830	95921830	95921825	95921830
65-315	55	95921821	95921821	95921822	95921821
65-315	75	95921832	95921832	95921827	95921832
65-315	90	95921837	95921837	95921838	95921837
65-315	110	95921880	95921881	95921879	95921880
80-200	45	95921807	95921808	95921807	95921807
80-200	55	95921819	95921819	95921820	95921819
80-250	45	95921871	95921872	95921871	95921871
80-250	55	95921873	95921873	95921874	95921873
80-250	75	95921876	95921876	95921875	95921876
80-250	90	95921877	95921877	95921878	95921877
80-315	90	95921841	95921841	95921842	95921841
80-315	110	95921852	95921853	95921846	95921852
80-315	132	95921882	95921883	95921884	95921882
80-315	160	95921888	95921889	95921890	95921888
100-200	45	95921805	95921806	95921805	95921805
100-200	55	95921815	95921815	95921816	95921815
100-200	75	95921830	95921830	95921825	95921830
100-250	55	95921821	95921821	95921822	95921821
100-250	75	95921832	95921832	95921827	95921832
100-250	90	95921837	95921837	95921838	95921837
100-250	110	95921880	95921881	95921879	95921880
100-250	132	95921885	95921886	95921887	95921885
100-315	110	95921852	95921853	95921846	95921852
100-315	132	95921882	95921883	95921884	95921882
100-315	160	95921888	95921889	95921890	95921888
100-315	200	95921888	95921889	95921890	95921888
125-200	45	95921811	95921812	95921811	95921811
125-200	55	95921823	95921823	95921824	95921823
125-200	75	95921833	95921833	95921828	95921833
125-200	90	95921841	95921841	95921842	95921841
125-200	110	95921852	95921853	95921846	95921852
125-250	90	95921839	95921839	95921840	95921839
125-250	110	95921850	95921851	95921845	95921850
125-250	132	95921856	95921857	95921858	95921856
125-250	160	95921865	95921866	95921867	95921865
125-250	200	95921865	95921866	95921867	95921865
125-315	132	95921862	95921863	95921864	95921862
125-315	160	95921868	95921869	95921870	95921868
125-315	200	95921868	95921869	95921870	95921868
150-200	110	95921834	95921834	95921829	95921834
150-250	132	95921843	95921843	95921834	95921843
150-250	160	95921854	95921855	95921847	95921854
150-250	200	95921862	95921863	95921864	95921862

NB, 4-pole, 50 Hz

Pump type	P2 [kW]	Product number			
		Base frame			
		Siemens	MMG-E	MMG-G	MMG-H
80-400	37	95921891	95921892	95921891	95921892
80-400	45	95921899	95921900	95921901	95921901
100-400	37	95921893	95921894	95921893	95921894
100-400	45	95921902	95921903	95921904	95921904
100-400	55	95921911	95921911	95921912	95921911
125-315	37	95921893	95921894	95921893	95921894
125-315	45	95921902	95921903	95921904	95921904
125-400	37	95921895	95921896	95921895	95921896
125-400	45	95921905	95921906	95921907	95921907
125-400	55	95921913	95921913	95921914	95921913
125-400	75	95921922	95921922	95921919	95921922
125-400	90	95921925	95921925	95921926	95921925
125-500	55	95921915	95921915	95921916	95921915
125-500	75	95921923	95921923	95921920	95921923
125-500	90	95921927	95921927	95921928	95921927
125-500	110	95921933	95921934	95921931	95921933
125-500	132	95921937	95921938	95921939	95921937
125-500	160	95921943	95921944	95921945	95921943
150-250	37	95921893	95921894	95921893	95921894
150-250	45	95921902	95921903	95921904	95921904
150-315.2	37	95921949	95921950	95921949	95921950
150-315.2	45	95921951	95921952	95921953	95921953
150-315.2	55	95921954	95921954	95921955	95921954
150-315.2	75	95921957	95921957	95921956	95921957
150-315	37	95921949	95921950	95921949	95921950
150-315	45	95921951	95921952	95921953	95921953
150-315	55	95921954	95921954	95921955	95921954
150-315	75	95921957	95921957	95921956	95921957
150-315	90	95921958	95921958	95921930	95921958
150-400	55	95921965	95921965	95921966	95921965
150-400	75	95921968	95921968	95921967	95921968
150-400	90	95921969	95921969	95921970	95921969
150-400	110	95921935	95921936	95921932	95921935
150-400	132	95921940	95921941	95921942	95921940
150-400	160	95921946	95921947	95921948	95921946
150-500	132	95921937	95921938	95921939	95921937
150-500	160	95921943	95921944	95921945	95921943
150-500	200	95921937	95921944	95921937	95921937
200-400					
200-450					
250-350					
250-400					
250-450					
250-500					

Base frames are not available as an accessory for these pump sizes, but can be configured as part of the pump.

NB, 6-pole, 50 Hz

Pump type	P2 [kW]	Product number			
		Base frame			
		Siemens	MMG-E	MMG-G	MMG-H
125-400	30	95921905	95921906	95921907	95921907
125-500	30	95921959	95921960	95921961	95921961
125-500	37	95921915	95921915	95921916	95921915
125-500	45	95921962	95921962	95921971	95921962
125-500	55	95921963	95921963	95921964	-
150-315	30	95921951	95921952	95921953	95921953
150-400	30	95921908	95921909	95921910	95921910
150-400	37	95921965	95921965	95921966	95921965
150-400	45	95921968	95921968	95921967	95921968
150-500	37	95921915	95921915	95921916	95921915
150-500	45	95921962	95921962	95921971	95921962
150-500	55	95921963	95921963	95921964	-
150-500	75	95921933	95921933	95921931	-
200-400					
200-450					
250-350		Base frames are not available as an accessory for these pump sizes, but can be configured as part of the pump.			
250-400					
250-450					
250-450					
250-500					

Electrical data, IE1 motors

MG, 4-pole

Motor	Frame size	IE class	Voltage [V]	P2 [kW]	I _{1/1} [A]	η [%]	Cos φ 1/1	n [min ⁻¹]	$\frac{I_{start}}{I_{1/1}}$
MG-C	71A	IE1	3 x 220-240 Δ / 380-415 Y	0.25	1.48 / 0.85	69-69	0.75 - 0.65	1400-1420	4.0 - 4.4
MG-C	71B	IE1		0.37	1.9 / 1.1	71-71	0.77 - 0.67	1400-1420	4.0 - 4.4
MG-C	80A	IE1		0.55	2.6 / 1.5	77-77	0.79 - 0.70	1390-1410	4.3 - 4.7

Electrical data, IE2 motors

MMG-E, 2-pole

Motor	Frame size	IE class	Voltage [V]	P2 [kW]	I _{1/1} [A]	η [%]	Cos φ 1/1	n [min ⁻¹]	$\frac{I_{start}}{I_{1/1}}$
MMG-E	71A	-	220-240 Δ / 380-415 Y	0.37	1.74 / 1.1	70.0	0.77	2800	5.1
MMG-E	71B	-		0.55	2.2 / 1.3	77.0	0.80	2810	6.4
MMG-E	80A	IE2	220-240 Δ / 380-415 Y	0.75	2.8 / 1.6	81.5	0.82	2880	7.9
MMG-E	80B	IE2		1.1	4.1 / 2.4	81.8	0.83	2870	7.9
MMG-E	90S	IE2		1.5	5.8 / 3.4	83.0	0.79	2880	8.9
MMG-E	90L	IE2		2.2	8.3 / 4.8	83.4	0.81	2870	8.3
MMG-E	100L	IE2		3	10.2 / 5.9	86.3	0.86	2880	8.9
MMG-E	112M	IE2		4	14 / 8.1	87.1	0.86	2910	9.1
MMG-E	90L	IE2		2.2	4.8 / 2.8	83.4	0.81	2870	8.3
MMG-E	100L	IE2		3	5.9 / 3.4	86.3	0.86	2880	8.9
MMG-E	112M	IE2		4	8.1 / 4.7	87.1	0.86	2910	9.1
MMG-E	132SA	IE2		5.5	10.4 / 6.0	88.4	0.87	2910	7.8
MMG-E	132SB	IE2		7.5	14 / 8.1	88.4	0.88	2900	7.6
MMG-E	160MA	IE2		11	20.2 / 11.6	89.8	0.89	2930	6.2
MMG-E	160MB	IE2		15	27 / 15.6	90.5	0.89	2940	7.0
MMG-E	160L	IE2		18.5	33/19	91.5	0.89	2940	7.3
MMG-E	180M	IE2		22	39.5 / 23	92.1	0.88	2960	8.3
MMG-E	200LA	IE2		30	52/30	92.5	0.90	2950	7.8
MMG-E	200LB	IE2	37	64/37	92.9	0.90	2960	7.6	
MMG-E	225M	IE2	380-415 Δ / 660-690 Y	45	79/46	92.9	0.90	2960	6.7
MMG-E	250M	IE2		55	94/55	94.0	0.90	2970	8.3
MMG-E	280S	IE2		75	130/75	94.1	0.90	2980	7.7
MMG-E	280M	IE2		90	154/89	94.5	0.92	2980	8.0
MMG-E	315S	IE2		110	188/110	94.5	0.89	2980	8.1
MMG-E	315M	IE2		132	220/130	94.8	0.92	2970	6.2
MMG-E	315LA	IE2		160	265/156	94.8	0.93	2970	6.0
MMG-E	315LB	IE2		200	330/190	95.2	0.93	2970	5.8
MMG-E	355M	IE2		250	410/236	95.0	0.93	2980	7.1
MMG-E	355L	IE2		315	515/295	95.1	0.94	2980	7.2

MMG-E, 4-pole

Motor	Frame size	IE class	Voltage [V]	P2 [kW]	I _{1/1} [A]	η [%]	Cos φ 1/1	n [min ⁻¹]	I _{start} / I _{1/1}
MMG-E	071A	-	220-240 Δ / 380-415 Y	0.25	1.2 / 0.7	72.6	0.71	1375	4.7
MMG-E	071B	-		0.37	1.7 / 1	71.9	0.74	1360	4.4
MMG-E	80MA	-		0.55	2.8 / 1.6	70.0	0.76	1400	4.4
MMG-E	80MB	IE2	220-240 Δ / 380-415 Y	0.75	3.6 / 2.1	79.8	0.80	1430	6.7
MMG-E	090S	IE2		1.1	4.7 / 2.7	82.2	0.73	1440	7.3
MMG-E	090L	IE2		1.5	5.9 / 3.4	82.8	0.77	1430	6.5
MMG-E	100LA	IE2		2.2	8.8 / 5.1	83.4	0.77	1450	8.4
MMG-E	100LB	IE2		3.0	11 / 6.3	86.7	0.80	1440	7.0
MMG-E	112M	IE2		4.0	13.8 / 8	87.2	0.83	1450	8.9
MMG-E	100LA	IE2		2.2	5.1 / 3.0	83.4	0.76	1450	8.4
MMG-E	100LB	IE2		3.0	6.3 / 3.6	86.7	0.80	1440	6.9
MMG-E	112M	IE2		4.0	8 / 4.6	87.2	0.83	1450	8.7
MMG-E	132S	IE2		5.5	10.6 / 6.2	88.8	0.85	1460	8.0
MMG-E	132M	IE2	7.5	14.2 / 8.2	89.8	0.85	1460	8.7	
MMG-E	160M	IE2	11	21.6 / 12.5	90.4	0.81	1470	8.3	
MMG-E	160L	IE2	15	29 / 16.7	90.5	0.83	1470	8.2	
MMG-E	180M	IE2	18.5	33 / 19.1	92.0	0.87	1470	7.7	
MMG-E	180L	IE2	22	40/23	92.3	0.86	1470	7.9	
MMG-E	200L	IE2	30	53/31	92.8	0.87	1480	8.7	
MMG-E	225S	IE2	37	67/38	93.2	0.87	1480	6.7	
MMG-E	225M	IE2	45	80/46	93.1	0.88	1480	7.5	
MMG-E	250M	IE2	55	98/57	94.2	0.84	1490	8.5	
MMG-E	280S	IE2	75	132/77	94.5	0.88	1480	8.7	
MMG-E	280M	IE2	90	154/89	94.8	0.89	1480	9.5	
MMG-E	315S	IE2	110	195/113	94.7	0.88	1490	7.1	
MMG-E	315M	IE2	132	235/136	94.8	0.88	1490	7.1	
MMG-E	315LA	IE2	160	285/165	95.0	0.88	1490	7.2	
MMG-E	315LB	IE2	200	350/202	95.1	0.87	1490	7.2	
MMG-E	355M	IE2	250	425/245	95.3	0.91	1490	6.3	
MMG-E	355L	IE2	315	535/309	95.4	0.90	1490	6.6	

MMG-E, 6-pole

Motor	Frame size	IE class	Voltage [V]	P2 [kW]	I _{1/1} [A]	η [%]	Cos φ 1/1	n [min ⁻¹]	I _{start} / I _{1/1}
MMG-E	090S	IE2	220-240 Δ / 380-415 Y	0.75	3.4 / 1.9	76.0	0.73	930	4.4
MMG-E	090L	IE2		1.1	4.8 / 2.8	79.0	0.73	930	4.7
MMG-E	100L	IE2		1.5	6.3 / 3.7	79.9	0.74	950	4.9
MMG-E	112M	IE2		2.2	8.7 / 4.5	83.4	0.77	960	6.2
MMG-E	132S	IE2		3.0	12.6 / 7.3	84.6	0.74	970	6.7
MMG-E	132MA	IE2		4.0	16.2 / 9.3	85.0	0.73	970	7.4
MMG-E	112M	IE2		2.2	4.5 / 2.6	83.4	0.77	960	6.2
MMG-E	132S	IE2		3.0	7.3 / 4.2	84.6	0.74	970	6.7
MMG-E	132MA	IE2		4.0	9.3 / 5.4	85.0	0.73	970	7.4
MMG-E	132MB	IE2		5.5	12.4 / 7.2	86.3	0.75	970	7.5
MMG-E	160M	IE2	7.5	16.4 / 9.5	87.5	0.76	970	6.9	
MMG-E	160L	IE2	11	23.6 / 13.6	88.7	0.76	970	7.1	
MMG-E	180L	IE2	15	31.5 / 18.2	89.7	0.76	980	7.0	
MMG-E	200LA	IE2	18.5	36.5 / 21.1	90.3	0.81	980	7.4	
MMG-E	200LB	IE2	22	44/25	91.0	0.79	980	8.2	
MMG-E	225M	IE2	30	55/32	91.8	0.86	980	5.7	
MMG-E	250M	IE2	37	69/40	92.5	0.84	980	8.0	
MMG-E	280S	IE2	45	86/50	92.8	0.82	980	6.3	
MMG-E	280M	IE2	55	103/60	93.2	0.82	980	6.3	
MMG-E	315S	IE2	75	134/77	93.8	0.87	990	7.0	
MMG-E	315M	IE2	90	162/94	94.0	0.86	990	7.3	
MMG-E	315LA	IE2	110	194/112	94.3	0.87	990	7.4	
MMG-E	315LB	IE2	132	230/133	94.6	0.88	990	6.7	
MMG-E	355MA	IE2	160	288/166	94.8	0.85	990	6.7	
MMG-E	355MB	IE2	185	327/189	95.0	0.86	990	6.3	
MMG-E	355MC	IE2	200	355/205	95.0	0.86	990	6.6	
MMG-E	355MD	IE2	220	397/229	95.0	0.84	990	7.1	
MMG-E	355L	IE2	250	440/254	95.1	0.86	990	6.3	

MMG-G, 2-pole

Motor	Frame size	IE class	Voltage [V]	P2 [kW]	I _{1/1} [A]	η [%]	Cos φ 1/1	n [min ⁻¹]	I _{start} / I _{1/1}
MMG-G	71	-	3 x 220-240 Δ / 380-415 Y	0.55	2.46 - 1.42 / 1.42 - 1.30	74.3	0.80	2770	6.8
MMG-G	80	IE2	3 x 220-240 Δ / 380-415 Y	0.75	2.90 / 1.68	80.0	0.85	2810	6.3
MMG-G	80	IE2		1.1	4.15 / 2.42	82.5	0.84	2810	6.7
MMG-G	90S	IE2		1.5	5.50 / 3.20	84.1	0.85	2810	7.2
MMG-G	90L	IE2		2.2	7.95 / 4.60	85.7	0.85	2820	7.3
MMG-G	100L	IE2		3	10.4 / 6.05	86.7	0.87	2850	8.6
MMG-G	112M	IE2	3 x 380-415 Δ	4	13.8 / 7.95	87.6	0.87	2860	8.3
MMG-G	90L	IE2		2.2	4.55 - 4.35	85.1 - 84.8	0.86 - 0.83	2820-2840	7.3
MMG-G	100L	IE2		3	6.00 - 5.65	86.7 - 86.4	0.88 - 0.85	2850-2870	8.6
MMG-G	112M	IE2		4	7.90 - 7.45	87.8 - 87.5	0.88 - 0.85	2860-2880	8.3
MMG-G	132S	IE2		5.5	10.2 - 9.85	90.5 - 90.9	0.90 - 0.85	2900-2920	7.2
MMG-G	132S	IE2		7.5	14.0 - 14.0	89.9 - 90.2	0.91 - 0.83	2890-2910	6.7
MMG-G	160M	IE2		11	20.6 / 11.8	90.4	0.91	2910	7.2
MMG-G	160M	IE2		15	27.5 / 15.8	91.1	0.91	2920	7.1
MMG-G	160L	IE2		18.5	33.5 / 19.2	91.6	0.92	2920	8.4
MMG-G	180MA	IE2		22	39.0 / 22.6	92.8	0.92	2940	8.6
MMG-G	200LA	IE2	30	55.5 / 32.0	92.7	0.88	2940	8.6	
MMG-G	200LA	IE2	37	66.5 / 38.5	93.7	0.90	2940	8.6	
MMG-G	225MA	IE2	45	81.0 / 46.5	93.8	0.90	2940	8.4	
MMG-G	250SA	IE2	55	97.5 / 56.0	94.0	0.91	2950	7.4	
MMG-G	250MA	IE2	75	130 / 75.0	95.0	0.92	2950	7.5	
MMG-G	280SA	IE2	90	158 / 91.0	95.0	0.91	2950	7.0	
MMG-G	280MA	IE2	110	190/110	95.5	0.92	2960	7.6	
MMG-G	315SA	IE2	132	230/132	95.5	0.91	2980	7.5	
MMG-G	315MA	IE2	160	280/162	95.6	0.90	2980	7.0	
MMG-G	315MA	IE2	200	355/204	94.0	0.90	2980	8.0	
MMG-G	315CA	IE2	250	455/260	94.2	0.89	2970	6.4	
MMG-G	315DA	IE2	315	560/325	94.5	0.90	2970	6.5	
MMG-G	355AA	IE2	355	630/365	94.8	0.90	2970	6.5	

MMG-G, 4-pole

Motor	Frame size	IE class	Voltage [V]	P2 [kW]	I _{1/1} [A]	η [%]	Cos φ 1/1	n [min ⁻¹]	I _{start} / I _{1/1}
MMG-G	71	-	3 x 220-240 Δ / 380-415 Y	0.37	2.02 - 1.86 / 1.18 - 1.06	68.5	0.70	1390	5.3
MMG-G	80	-	3 x 220-240 Δ / 380-415 Y	0.55	2.60 / 1.50	80.0	0.70	1390	5.7
MMG-G	80	IE2		0.75	3.25 / 1.90	81.5	0.74	1400	5.7
MMG-G	90S	IE2		1.1	4.30 / 2.50	83.8	0.80	1410	6.1
MMG-G	90L	IE2		1.5	5.80 / 3.35	85.0	0.80	1400	6.4
MMG-G	100L	IE2		2.2	7.75 / 4.50	86.5	0.86	1410	6.7
MMG-G	100L	IE2	3	11.0 / 6.35	87.5	0.82	1420	7.7	
MMG-G	112M	IE2	4	14.2 / 8.20	88.5	0.84	1430	7.7	
MMG-G	100L	IE2	2.2	4.50 - 4.25	86.5 - 86.2	0.86 - 0.83	1410-1430	9.6	
MMG-G	100L	IE2	3	6.35 - 6.05	87.5 - 87.2	0.82 - 0.79	1420-1440	9.8	
MMG-G	112M	IE2	4	8.20 - 7.75	88.5 - 88.2	0.84 - 0.81	1430-1450	9.8	
MMG-G	132S	IE2	5.5	11.0 - 10.4	89.1 - 89.2	0.86 - 0.82	1450-1470	9.8	
MMG-G	132M	IE2	7.5	14.6 / 8.40	91.0	0.86	1450	9.5	
MMG-G	160M	IE2	11	20.6 / 11.8	92.5	0.88	1450	9.0	
MMG-G	160L	IE2	15	31.0 / 17.8	93.7	0.89	1450	8.6	
MMG-G	180MC	IE2	18.5	35.0 / 20.0	94.0	0.86	1460	8.8	
MMG-G	180LC	IE2	22	41.0 / 23.6	94.0	0.87	1460	8.3	
MMG-G	200LC	IE2	30	55.0 / 31.5	94.5	0.88	1460	9.3	
MMG-G	225SC	IE2	37	69.0 / 39.5	95.0	0.86	1470	7.8	
MMG-G	225MC	IE2	45	84.0 / 48.5	95.0	0.86	1470	7.4	
MMG-G	250SC	IE2	55	100 / 58.0	95.5	0.87	1480	7.4	
MMG-G	250MC	IE2	75	138 / 79.0	95.5	0.87	1480	7.3	
MMG-G	280SB	IE2	90	164 / 94.0	95.4	0.88	1480	7.0	
MMG-G	280MC	IE2	110	200/114	95.4	0.88	1480	6.8	
MMG-G	315SC	IE2	132	240/138	95.4	0.88	1490	6.0	
MMG-G	315MCB	IE2	160	290/166	95.4	0.88	1490	6.0	
MMG-G	315MB	IE2	200	335/192	95.8	0.88	1480	7.8	
MMG-G	315CB	IE2	250	450/260	94.5	0.89	1480	6.4	
MMG-G	315DB	IE2	315	565/325	94.8	0.89	1480	6.4	

MMG-G, 6-pole

Motor	Frame size	IE class	Voltage [V]	P2 [kW]	I _{1/1} [A]	η [%]	Cos φ 1/1	n [min ⁻¹]	I _{start} / I _{1/1}
MMG-G 80	80	-	3 x 220-240 Δ / 380-415 Y	0.37	2.36 - 2.16 / 1.36 - 1.24	66.0	0.60	910	4.4
MMG-G 80	80	-		0.55	3.10 / 1.80	75.0	0.62	910	5.0
MMG-G 90S	90S	IE2	3 x 220-240 Δ / 380-415 Y	0.75	3.90 / 2.26	77.7	0.65	920	4.8
MMG-G 90L	90L	IE2		1.1	5.50 / 3.20	79.9	0.66	920	4.7
MMG-G 100L	100L	IE2		1.5	7.00 / 4.05	81.0	0.70	920	5.3
MMG-G 112M	112M	IE2		2.2	9.00 / 5.20	82.6	0.78	930	5.9
MMG-G 132S	132S	IE2		3	11.2 / 6.45	88.5	0.80	970	7.4
MMG-G 132M	132M	IE2		4	14.8 / 8.60	89.5	0.79	970	7.4
MMG-G 112M	112M	IE2		2.2	5.20 / 3.00	82.6	0.78	930	5.9
MMG-G 132S	132S	IE2		3	6.45 / 3.70	88.5	0.80	970	7.4
MMG-G 132M	132M	IE2		4	8.60 / 4.95	89.5	0.79	970	7.4
MMG-G 132M	132M	IE2		5.5	11.4 / 6.60	89.0	0.82	960	6.5
MMG-G 160M	160M	IE2		7.5	15.4 / 8.90	91.0	0.81	970	6.7
MMG-G 160L	160L	IE2		11	23.0 / 13.4	91.0	0.79	980	7.4
MMG-G 180LC	180LC	IE2		15	29.5 / 17.0	91.5	0.84	970	6.1
MMG-G 200LC	200LC	IE2		18.5	37.5 / 21.6	93.0	0.81	980	6.4
MMG-G 200LC	200LC	IE2	22	43.5 / 25.0	93.5	0.83	980	6.2	
MMG-G 225MC	225MC	IE2	30	56.5 / 32.5	94.0	0.86	980	5.9	
MMG-G 250SC	250SC	IE2	37	68.5 / 39.5	94.0	0.87	990	6.4	
MMG-G 250MC	250MC	IE2	45	82.5 / 47.5	94.5	0.88	990	7.0	
MMG-G 280SB	280SB	IE2	55	106 / 60.5	94.5	0.84	980	6.4	
MMG-G 280MB	280MB	IE2	75	140 / 80.5	95.0	0.86	980	6.7	
MMG-G 315SB	315SB	IE2	90	168 / 96.0	95.3	0.86	990	6.7	
MMG-G 315MB	315MB	IE2	110	200/114	95.4	0.88	990	6.4	
MMG-G 315MB	315MB	IE2	132	246/140	95.8	0.86	990	6.4	
MMG-G 315MB	315MB	IE2	160	295/170	95.0	0.87	980	6.3	

MMG-H2, 2-pole

Motor	Frame size	IE class	Voltage [V]	P2 [kW]	I _{1/1} [A]	η [%]	Cos φ 1/1	n [min ⁻¹]	I _{start} / I _{1/1}
MMG-H2 71B	71B	-	3 x 220-240 Δ / 380-420 Y	0.55	2.42 - 2.22 / 1.40 - 1.26		0.82	2820	6.1 - 6.1
MMG-H2 80B	80B	IE2		0.75	3.20 - 2.90 / 1.84 - 1.66	79.3	0.78	2880	7.0 - 7.0
MMG-H2 80B	80B	IE2	3 x 220-240 Δ / 380-420 Y	1.1	4.50 - 4.10 / 2.60 - 2.36	81.3	0.79	2880	7.0 - 7.0
MMG-H2 90S	90S	IE2		1.5	5.40 - 4.95 / 3.10 - 2.80	83.0	0.88	2900	8.5 - 8.5
MMG-H2 90L	90L	IE2		2.2	7.70 - 7.05 / 4.45 - 4.05	84.2	0.89	2900	8.5 - 8.5
MMG-H2 100LA	100LA	IE2		3	10.2 - 9.40 / 5.95 - 5.35	85.4	0.90	2900	9.0 - 9.0
MMG-H2 112M	112M	IE2		4	13.6 - 12.6 / 7.90 - 7.15	86.3	0.89	2920	9.0 - 9.0
MMG-H2 90L	90L	IE2		2.2	4.45 - 4.05 / 2.55 - 2.34	84.2	0.89	2900	8.5 - 8.5
MMG-H2 100LA	100LA	IE2		3	5.95 - 5.35 / 3.40 - 3.10	85.4	0.90	2900	9.0 - 9.0
MMG-H2 112M	112M	IE2		4	7.90 - 7.15 / 4.55 - 4.15	86.3	0.89	2920	9.0 - 9.0
MMG-H2 132SA	132SA	IE2		5.5	10.8 - 9.70 / 6.20 - 5.60	87.5	0.89	2930	8.5 - 8.5
MMG-H2 132SB	132SB	IE2		7.5	14.4 - 13.2 / 8.35 - 7.60	88.4	0.89	2930	8.5 - 8.5
MMG-H2 160MA	160MA	IE2		11	20.6 - 18.6 / 11.8 - 10.8	89.9	0.90	2940	7.5 - 7.5
MMG-H2 160MB	160MB	IE2		15	28.0 - 25.5 / 16.0 - 14.6	90.7	0.90	2940	7.5 - 7.5
MMG-H2 160L	160L	IE2		18.5	34.0 - 30.5 / 19.6 - 17.8	91.2	0.91	2940	7.5 - 7.5
MMG-H2 180M	180M	IE2		22	40.0 - 36.5 / 23.2 - 21.0	91.5	0.91	2950	7.5 - 7.5
MMG-H2 200LA	200LA	IE2	3 x 380-420 Δ / 660-725 Y	30	54.5 - 49.0 / 31.5 - 28.5	92.2	0.91	2950	7.5 - 7.5
MMG-H2 200LB	200LB	IE2		37	66.5 - 60.5 / 38.5 - 35.0	92.6	0.91	2950	7.5 - 7.5
MMG-H2 225M	225M	IE2		45	80.5 - 73.0 / 46.5 - 42.5	93.1	0.91	2960	7.5 - 7.5
MMG-H2 250M	250M	IE2		55	99.5 - 90.0 / 57.0 - 52.0	93.4	0.90	2970	7.5 - 7.5
MMG-H2 280S	280S	IE2		75	134-122 / 76.5 - 70.0	94.0	0.91	2970	7.5 - 7.5
MMG-H2 280MA	280MA	IE2		90	160-144 / 91.5 - 83.5	94.5	0.91	2980	7.5 - 7.5
MMG-H2 315S	315S	IE2		110	194-176 / 112-102	94.6	0.91	2980	7.1 - 7.1
MMG-H2 315M	315M	IE2		132	232-210 / 134-122	94.8	0.91	2980	7.1 - 7.1
MMG-H2 315L	315L	IE2		160	280-255 / 162-148	95.0	0.91	2980	7.1 - 7.1
MMG-H2 315L	315L	IE2		200	350-315 / 202-184	95.7	0.91	2980	7.1 - 7.1

MMG-H2, 4-pole

Motor	Frame size	IE class	Voltage [V]	P2 [kW]	I _{1/1} [A]	η [%]	Cos φ 1/1	n [min ⁻¹]	I _{start} / I _{1/1}
MMG-H2	71B	-	3 x 220-240 Δ / 380-420 Y	0.25	1.36 - 1.26 / 0.79 - 0.79		0.74	1350	5.2 - 5.2
MMG-H2	71B	-		0.37	1.94 - 1.78 / 1.12 - 1.02		0.75	1340	5.2 - 5.2
MMG-H2	80B	-	3 x 220-240 Δ / 380-420 Y	0.55	2.55 - 2.36 / 1.48 - 1.34		0.73	1420	8.8 - 8.8
MMG-H2	80B	IE2		0.75	3.40 - 3.10 / 1.96 - 1.78	79.6	0.73	1420	8.8 - 8.8
MMG-H2	90S	IE2		1.1	4.50 - 4.10 / 2.60 - 2.36	81.4	0.79	1450	8.8 - 8.8
MMG-H2	90L	IE2		1.5	6.00 - 5.50 / 3.50 - 3.15	82.8	0.79	1450	8.5 - 8.5
MMG-H2	100LA	IE2		2.2	8.80 - 8.05 / 5.10 - 4.60	84.3	0.78	1440	9.0 - 9.0
MMG-H2	100LB	IE2		3.0	11.8 - 10.8 / 6.85 - 6.20	85.5	0.78	1440	9.0 - 9.0
MMG-H2	112M	IE2		4.0	14.6 - 13.4 / 8.40 - 7.60	87.0	0.83	1460	8.8 - 8.8
MMG-H2	100LA	IE2		2.2	5.10 - 4.60 / 2.95 - 2.65	84.3	0.78	1440	9.0 - 9.0
MMG-H2	100LA	IE2		3.0	6.85 - 6.20 / 3.95 - 3.60	85.5	0.78	1440	9.0 - 9.0
MMG-H2	112M	IE2		4.0	8.40 - 7.60 / 4.85 - 4.40	87.0	0.83	1460	8.8 - 8.8
MMG-H2	132SA	IE2		5.5	11.6 - 10.6 / 6.70 - 6.10	87.8	0.82	1460	8.5 - 8.5
MMG-H2	132MA	IE2		7.5	15.4 - 14.0 / 8.90 - 8.10	89.0	0.83	1460	8.2 - 8.2
MMG-H2	160MA	IE2		11	21.8 - 19.8 / 12.6 - 11.4	90.3	0.85	1460	7.0 - 7.0
MMG-H2	160L	IE2		15	29.0 - 26.5 / 16.8 - 15.2	91.0	0.86	1460	7.5 - 7.5
MMG-H2	180MA	IE2		18.5	36.0 - 32.5 / 20.6 - 18.8	91.3	0.86	1470	7.5 - 7.5
MMG-H2	180L	IE2		22	42.5 - 38.5 / 24.4 - 22.2	91.8	0.86	1470	7.5 - 7.5
MMG-H2	200LA	IE2	3 x 380-420 Δ / 660-725 Y	30	55.5 - 50.0 / 32.0 - 29.0	92.5	0.89	1470	7.2 - 7.2
MMG-H2	225S	IE2		37	69.0 - 62.5 / 39.5 - 36.0	93.9	0.87	1480	7.2 - 7.2
MMG-H2	225M	IE2		45	84.0 - 76.0 / 48.5 - 44.0	93.3	0.87	1480	7.2 - 7.2
MMG-H2	250MA	IE2		55	100 - 90.5 / 57.5 - 52.5	93.9	0.89	1480	7.2 - 7.2
MMG-H2	280SA	IE2		75	134-126 / 80.0 - 73.0	94.1	0.87	1490	7.2 - 7.2
MMG-H2	280MA	IE2		90	168-152 / 96.0 - 87.5	94.3	0.87	1490	7.2 - 7.2
MMG-H2	315S	IE2		110	200-182 / 116-106	94.8	0.88	1490	6.9 - 6.9
MMG-H2	315M	IE2		132	240-218 / 138-126	94.9	0.88	1490	6.9 - 6.9
MMG-H2	315L	IE2		160	290-265 / 168-152	95.2	0.88	1490	6.9 - 6.9
MMG-H2	315L	IE2		200	365-330 / 210-190	95.2	0.88	1490	6.9 - 6.9

MMG-H2, 6-pole

Motor	Frame size	IE class	Voltage [V]	P2 [kW]	I _{1/1} [A]	η [%]	Cos φ 1/1	n [min ⁻¹]	I _{start} / I _{1/1}
MMG-H2	80	-	3 x 220-240 Δ / 380-420 Y	0.55	2.80 - 0.25 / 1.62 - 1.46		0.70	905	6.7 - 6.7
MMG-H2	90S	IE2		0.75	3.70 - 0.34 / 2.14 - 1.94	76.0	0.70	920	7.5 - 7.5
MMG-H2	90L	IE2	3 x 220-240 Δ / 380-420 Y	1.1	5.25 - 0.48 / 3.05 - 2.75	78.3	0.70	920	7.5 - 7.5
MMG-H2	100L	IE2		1.5	6.95 - 0.63 / 4.00 - 3.65	79.8	0.71	925	7.5 - 7.5
MMG-H2	112M	IE2		2.2	9.80 - 0.90 / 5.70 - 5.15	81.8	0.72	925	7.5 - 7.5
MMG-H2	132S	IE2		3.0	12.6 - 1.16 / 7.30 - 6.60	83.3	0.75	950	8.5 - 8.5
MMG-H2	132M	IE2		4.0	16.4 - 1.50 / 9.45 - 8.55	84.6	0.76	950	9.0 - 9.0
MMG-H2	132M	IE2		4.0	9.45 - 0.85 / 5.45 - 4.95	84.6	0.76	950	9.0 - 9.0
MMG-H2	132M	IE2		5.5	12.8 - 1.16 / 7.35 - 6.70	86.0	0.76	960	9.5 - 9.5
MMG-H2	160M	IE2		7.5	17.0 - 15.4 / 9.75 - 8.90	87.4	0.77	970	6.5 - 6.5
MMG-H2	160L	IE2		11	24.2 - 21.8 / 13.8 - 12.6	88.9	0.78	970	6.4 - 6.4
MMG-H2	180L	IE2		15	31.5 - 28.5 / 18.0 - 16.4	89.9	0.81	970	7.0 - 7.0
MMG-H2	200LA	IE2	3 x 380-420 Δ / 660-725 Y	18.5	38.5 - 34.5 / 22.0 - 20.0	90.5	0.81	980	7.0 - 7.0
MMG-H2	200LB	IE2		22	45.5 - 41.0 / 26.0 - 23.8	90.9	0.81	980	7.0 - 7.0
MMG-H2	225M	IE2		30	59.0 - 53.5 / 34.0 - 31.0	91.8	0.84	980	7.0 - 7.0
MMG-H2	250M	IE2		37	70.0 - 63.5 / 40.5 - 36.5	92.3	0.87	980	7.0 - 7.0
MMG-H2	280S	IE2		45	85.5 - 77.5 / 49.5 - 45.0	92.8	0.86	990	7.0 - 7.0
MMG-H2	280MA	IE2		55	104 - 94.5 / 60.0 - 54.5	93.2	0.86	980	7.0 - 7.0
MMG-H2	315S	IE2		75	142-130 / 82.5 - 75.0	93.8	0.85	980	7.0 - 7.0
MMG-H2	315M	IE2		90	170-154 / 98.5 - 89.5	94.2	0.85	980	7.0 - 7.0
MMG-H2	315L	IE2		110	206-186 / 118-108	94.4	0.86	980	6.7 - 6.7
MMG-H2	315L	IE2		132	246-224 / 142-130	94.6	0.86	980	6.7 - 6.7
MMG-H2	355M	IE2	160	290-265 / 168-152	94.9	0.88	990	6.7 - 6.7	

Electrical data, IE3 motors

MG, 2-pole

Motor	Frame size	IE class	Voltage [V]	P2 [kW]	I _{1/1} [A]	η [%]	Cos φ 1/1	n [min ⁻¹]	I _{start} / I _{1/1}
MG-C	71A	IE3	3 x 220-240 Δ / 380-415 Y	0.37	1.74 / 1.00	78.5	0.80 - 0.70	2850-2880	4.9 - 5.3
MG-C	71B	IE3		0.55	2.50 / 1.44	80.0	0.80 - 0.70	2830-2850	5.8 - 6.2
MG-H3	80A	IE3		0.75	3.30 / 1.90	80.7	0.81 - 0.71	2840-2870	5.8 - 6.2
MG-H3	80C	IE3		1.1	4.35 / 2.50	82.7	0.83 - 0.76	2840-2870	4.5 - 5.0
MG-H3	90SB	IE3	3 x 220-240 Δ / 380-415 Y	1.5	5.45 / 3.15	84.2	0.87 - 0.82	2890-2910	8.5 - 9.3
MG-H3	90LC	IE3		2.2	7.70 / 4.45	85.9	0.89 - 0.87	2890-2910	8.5 - 9.5
MG-H3	100LC	IE3		3	11.0 / 6.30	87.1	0.87 - 0.82	2900-2920	8.4 - 9.2
MG-H3	112MC	IE3		4	13.6 / 7.90	88.1	0.87	2920-2940	10.0 - 11.1
MG-H3	90LC	IE3	3 x 380-415 Δ	2.2	4.45	85.9	0.89 - 0.87	2890-2910	8.5 - 9.5
MG-H3	100LC	IE3		3	6.30	87.1	0.87 - 0.82	2900-2920	8.4 - 9.2
MG-H3	112MC	IE3		4	7.90	88.1	0.87	2920-2940	10.0 - 11.1
MG-H3	132SC	IE3		5.5	11.0	89.2	0.87 - 0.82	2920-2940	10.8 - 11.8
MG-H3	132SB	IE3		7.5	14.4 - 14.0 / 8.30 - 8.10	90.1	0.88 - 0.82	2910-2920	7.8 - 9.1
MG-H3	160MB	IE3		11	20.8 - 19.8 / 12.0 - 11.8	91.2	0.88 - 0.84	2940-2950	6.6 - 7.8
MG-H3	160MD	IE3	3 x 380-415 Δ / 660-690 Y	15	28.0 - 26.0 / 16.2 - 15.6	91.9	0.89 - 0.87	2930-2950	6.6 - 7.8
MG-H3	160LB	IE3		18.5	34.5 - 32.5 / 20.0 - 18.8	92.4	0.89 - 0.85	2940-2950	8.3 - 9.8
MG-H3	180MB	IE3		22	39.5 / 22.8	92.7	0.90	2950	8.3 - 8.3

MG, 4-pole

Motor	Frame size	IE class	Voltage [V]	P2 [kW]	I _{1/1} [A]	η [%]	Cos φ 1/1	n [min ⁻¹]	I _{start} / I _{1/1}
MG-H3	90SC	IE3	3 x 220-240 Δ / 380-415 Y	0.75	3.30 / 1.90	82.5	0.76 - 0.71	1440-1450	6.6 - 7.2
MG-H3	90SB	IE3		1.1	4.85 / 2.80	84.1	0.71 - 0.64	1450-1460	8.2 - 9.0
MG-H3	90LC	IE3		1.5	6.15 - 6.30 / 3.55 - 3.65	85.3	0.75 - 0.68	1450-1460	7.3 - 7.9
MG-H3	100LB	IE3		2.2	8.50 / 4.90	86.7	0.79 - 0.73	1450	6.0 - 6.6
MG-H3	100LC	IE3		3	11.0 / 6.30	87.7	0.82 - 0.76	1440-1450	7.0 - 7.7
MG-H3	112MC	IE3		4	16.2 / 9.30	88.6	0.75 - 0.68	1460	7.9 - 8.7
MG-H3	100LB	IE3	3 x 380-415 Δ	2.2	4.90	86.7	0.79 - 0.73	1450	6.0 - 6.6
MG-H3	100LC	IE3		3	6.30	87.7	0.82 - 0.76	1440-1450	7.0 - 7.7
MG-H3	112MC	IE3		4	9.30	88.6	0.75 - 0.68	1460	7.9 - 8.7
MG-H3	132SB	IE3		5.5	11.0 - 11.0 / 6.35 - 6.35	89.6	0.86 - 0.80	1460	7.0 - 7.6
MG-H3	132MB	IE3	3 x 380-415 Δ / 660-690 Y	7.5	14.9 - 14.2 / 8.60 - 8.40	90.4	0.86 - 0.82	1460	6.8 - 7.8
MG-H3	160MA	IE3		11	21.2 - 20.4 / 12.2 - 12.0	91.4	0.86 - 0.81	1470-1470	7.1 - 8.1
MG-H3	160LA	IE3		15	29.0 - 28.0 / 16.8 - 16.4	92.1	0.86 - 0.82	1460-1470	7.6 - 8.7

Siemens, 2-pole

Motor	Frame size	IE class	Voltage [V]	P2 [kW]	I _{1/1} [A]	η [%]	Cos φ 1/1	n [min ⁻¹]	I _{start} / I _{1/1}
Siemens 80M		IE3	3 x 220-240 Δ / 380-420 Y	0.75	2.80 - 2.60 / 1.60 - 1.50	80.7	0.86	2850	6.2
Siemens 80M		IE3		1.1	3.88 - 3.98 / 2.24 - 2.30	82.7	0.85	2885	7.1
Siemens 90S		IE3		1.5	5.37 - 5.11 / 3.1 - 2.95	84.2	0.86	2910	8.1
Siemens 90L		IE3		2.2	7.53 - 7.10 / 4.35 - 4.10	85.9	0.88	2910	8.3
Siemens 100L		IE3		3	10.2 - 9.20 / 5.90 - 5.30	87.1	0.88	2920	8.1
Siemens 112M		IE3		4	13.6 - 12.2 / 7.80 - 7.00	88.1	0.89	2955	8.0
Siemens 100L		IE3		3	5.90 - 5.30 / 3.40 - 3.10	87.1	0.88	2920	8.1
Siemens 112M		IE3		4	7.80 - 7.00 / 4.50 - 4.10	88.1	0.89	2955	8.0
Siemens 132S		IE3		5.5	10.4 - 9.40 / 6.00 - 5.40	89.2	0.90	2950	7.3
Siemens 132S		IE3		7.5	13.8 - 12.4 / 9.00 - 7.20	90.1	0.92	2950	8.3
Siemens 160M		IE3		11	21.0 - 19.0 / 12.2 - 11.0	91.2	0.87	2955	7.6
Siemens 160M		IE3		15	29.0 - 26.0 / 17.0 - 15.0	91.9	0.86	2955	8.4
Siemens 160L		IE3		18.5	33.5 - 30.5 / 19.6 - 17.6	92.4	0.90	2960	8.5
Siemens 180M		IE3		22	40.5 - 36.5 / 23.6 - 21.0	92.7	0.89	2950	7.5
Siemens 200L		IE3		30	56.0 - 51.0 / 32.0 - 29.5	93.3	0.86	2955	6.6
Siemens 200L		IE3		37	68.0 - 63.0 / 39.0 - 36.0	93.7	0.87	2955	6.7
Siemens 225M		IE3	3 x 380-420 Δ / 660-725 Y	45	82.0 - 75.0 / 47.5 - 43.5	94.0	0.89	2960	6.9
Siemens 250M		IE3	55	99.0 - 92.0 / 57.0 - 53.0	94.3	0.89	2975	6.7	
Siemens 280S		IE3	75	134-126 / 77.0 - 72.0	94.7	0.89	2975	6.8	
Siemens 280M		IE3	90	160-148 / 92.0 - 85.0	95.0	0.90	2975	7.2	
Siemens 315S		IE3	110	192-176 / 110-102	95.2	0.91	2980	7.1	
Siemens 315M		IE3	132	230-210 / 134-122	95.4	0.91	2980	7.2	
Siemens 315L		IE3	160	280-255 / 162-148	95.6	0.92	2980	7.8	
Siemens 315L		IE3	200	345-310 / 200-180	95.8	0.92	2980	7.2	
Siemens 315L		IE3	250	435-395 / 250-230	95.8	0.92	2985	8.8	
Siemens 315L		IE3	315	550-530 / 320-305	95.8	0.89	2990	9.0	
Siemens 355L		IE3	355	620-570 / 360-330	96.0	0.90	2980	6.5	

Siemens, 4-pole

Motor	Frame size	IE class	Voltage [V]	P2 [kW]	I _{1/1} [A]	η [%]	Cos φ 1/1	n [min ⁻¹]	I _{start} / I _{1/1}
Siemens 80		IE3	3 x 220-240 Δ / 380-420 Y	0.75	3.10 - 3.05 / 1.79 - 1.75	82.5	0.75	1450	7.1
Siemens 90S		IE3		1.1	4.25 - 4.20 / 2.45 - 2.40	84.1	0.78	1440	6.9
Siemens 90L		IE3		1.5	5.55 - 5.39 / 3.20 - 3.11	85.3	0.80	1445	7.2
Siemens 100L		IE3		2.2	8.00 - 7.30 / 4.60 - 4.20	86.7	0.83	1465	8.4
Siemens 100L		IE3		3	10.8 - 9.70 / 6.30 - 5.60	87.7	0.83	1460	8.3
Siemens 112M		IE3		4	14.6 - 13.2 / 8.40 - 7.60	88.6	0.82	1460	7.1
Siemens 100L		IE3		2.2	4.60 - 4.20 / 2.70 - 2.46	86.7	0.83	1465	8.4
Siemens 100L		IE3		3	6.30 - 5.60 / 3.60 - 3.30	87.7	0.83	1460	8.3
Siemens 112M		IE3		4	8.40 - 7.60 / 4.80 - 4.40	88.6	0.82	1460	7.1
Siemens 132S		IE3		5.5	11.2 - 10.0 / 6.40 - 5.80	89.6	0.84	1475	8.2
Siemens 132M		IE3		7.5	15.0 - 13.6 / 8.70 - 7.90	90.4	0.84	1465	8.2
Siemens 160M		IE3		11	22.0 - 20.0 / 12.6 - 11.6	91.4	0.84	1475	7.6
Siemens 160L		IE3		15	30.0 - 27.5 / 17.6 - 16.0	92.1	0.82	1475	8.5
Siemens 180M		IE3		18.5	37.0 - 33.5 / 21.6 - 19.6	92.6	0.82	1470	6.9
Siemens 180L		IE3		22	42.5 - 40.5 / 24.6 - 23.6	93.0	0.83	1470	6.8
Siemens 200L		IE3		30	57.5 - 54.0 / 33.5 - 31.5	93.6	0.84	1470	6.9
Siemens 225S		IE3	37	69.0 - 64.0 / 39.5 - 37.0	93.9	0.86	1480	6.4	
Siemens 225M		IE3	3 x 380-420 Δ / 660-725 Y	45	83.0 - 77.0 / 48.0 - 44.5	94.2	0.86	1480	6.4
Siemens 250M		IE3	55	100 - 93.0 / 58.0 - 54.0	94.6	0.87	1480	6.8	
Siemens 280S		IE3	75	140-130 / 80.0 - 74.0	95.0	0.86	1485	6.9	
Siemens 280M		IE3	90	166-152 / 95.0 - 88.0	95.2	0.87	1485	7.2	
Siemens 315S		IE3	110	200-186 / 116-108	95.4	0.87	1490	6.8	
Siemens 315M		IE3	132	240-220 / 140-128	95.6	0.87	1490	7.3	
Siemens 315L		IE3	160	285-265 / 166-154	95.8	0.87	1490	7.3	
Siemens 315L		IE3	200	355-330 / 206-190	96.0	0.88	1490	7.4	
Siemens 315L		IE3	250	455-420 / 260-240	96.0	0.87	1490	7.7	
Siemens 315L		IE3	315	570-550 / 330-320	96.0	0.86	1490	7.9	
Siemens 315L		IE3	355	650-610 / 375-355	96.1	0.85	1490	6.5	

Siemens, 6-pole

Motor	Frame size	IE class	Voltage [V]	P2 [kW]	I _{1/1} [A]	η [%]	Cos φ 1/1	n [min ⁻¹]	I _{start} / I _{1/1}
Siemens	80A	-	3 x 220-240 Δ / 380-415 Y	0.37	1.88 - 1.91 / 1.08 - 1.10	74.8	0.66	940	4.2
Siemens	80B	-		0.55	2.67 - 2.67 / 1.54 - 1.54	77.2	0.67	935	4.5
Siemens	90S	IE3	3 x 220-240 Δ / 380-420 Y	0.75	3.45 - 3.40 / 1.99 - 1.96	78.9	0.70	945	4.6
Siemens	90L	IE3		1.1	5.00 - 5.00 / 2.88 - 2.88	81.0	0.69	940	4.6
Siemens	100L	IE3		1.5	6.60 - 5.90 / 3.80 - 3.40	82.5	0.73	970	10
Siemens	112M	IE3		2.2	9.15 - 8.30 / 5.30 - 4.80	84.3	0.75	970	10
Siemens	132S	IE3		3	12.0 - 11.0 / 7.00 - 6.40	85.6	0.76	975	10
Siemens	132M	IE3		4	15.8 - 14.2 / 9.10 - 8.20	86.8	0.77	970	10
Siemens	112M	IE3		2.2	5.30 - 4.80 / 3.00 - 2.80	84.3	0.75	970	6.8
Siemens	132S	IE3		3	7.00 - 6.40 / 4.05 - 3.70	85.6	0.76	975	6.9
Siemens	132M	IE3		4	9.10 - 8.20 / 5.20 - 4.80	86.8	0.77	970	6.5
Siemens	132M	IE3		5.5	12.2 - 11.0 / 7.00 - 6.40	88.0	0.78	970	6.6
Siemens	160M	IE3	7.5	16.0 - 14.6 / 9.20 - 8.40	89.1	0.80	975	6.3	
Siemens	160L	IE3	11	23.2 - 21.0 / 13.4 - 12.2	90.3	0.80	975	6.6	
Siemens	180L	IE3	15	31.0 - 28.0 / 17.8 - 16.6	91.2	0.80	975	5.9	
Siemens	200L	IE3	18.5	38.0 - 36.5 / 22.0 - 21.0	91.7	0.79	980	5.6	
Siemens	200L	IE3	3 x 380-420 Δ / 660-725 Y	22	45.0 - 42.5 / 26.0 - 24.6	92.2	0.79	980	5.6
Siemens	225M	IE3		30	58.0 - 55.0 / 33.5 - 32.0	92.9	0.83	980	6.6
Siemens	250M	IE3		37	70.0 - 65.0 / 40.5 - 37.5	93.3	0.85	985	7.0
Siemens	280S	IE3		45	86.0 - 79.0 / 49.5 - 45.5	93.7	0.85	990	6.8
Siemens	280M	IE3		55	106 - 97.0 / 61.0 - 56.0	94.1	0.85	990	7.2
Siemens	315S	IE3		75	142-134 / 81.0 - 77.0	94.6	0.84	990	7.3
Siemens	315M	IE3		90	168-156 / 97.0 - 90.0	94.9	0.85	990	6.7
Siemens	315L	IE3		110	206-194 / 118-112	95.1	0.84	990	7.2
Siemens	315L	IE3		132	250-236 / 144-136	95.4	0.84	990	7.2
Siemens	315L	IE3		160	300-290 / 174-168	95.6	0.83	990	7.7

MMG-E, 2-pole

Motor	Frame size	IE class	Voltage [V]	P2 [kW]	I _{1/1} [A]	η [%]	Cos φ 1/1	n [min ⁻¹]	I _{start} / I _{1/1}
MMG-E 80A	80A	IE3	3 x 220-240 Δ / 380-415 Y	0.75	2.74 / 1.58	80.7	0.84	2980	7.43
MMG-E 80B	80B	IE3		1.1	4.0 / 2.3	82.7	0.83	2980	7.97
MMG-E 90S	90S	IE3		1.5	5.30 / 3.05	84.2	0.84	2870	8.55
MMG-E 90L	90L	IE3		2.2	7.40 / 4.25	85.9	0.87	2870	8.19
MMG-E 100L	100L	IE3		3	9.95 / 5.7	87.1	0.87	2890	9.26
MMG-E 112M	112M	IE3		4	7.4 / 4.3	88.1	0.89	2910	8.73
MMG-E 132SA	132SA	IE3		5.5	10.2 / 5.92	89.2	0.88	2970	8.89
MMG-E 132SB	132SB	IE3		7.5	13.6 / 7.9	90.1	0.89	2920	7.47
MMG-E 160MA	160MA	IE3		11	19.8 / 11.4	91.2	0.89	2950	8.43
MMG-E 160MB	160MB	IE3		15	26.5 / 15.4	91.9	0.90	2950	8.59
MMG-E 160L	160L	IE3	18.5	32.5 / 19	92.4	0.89	2950	8.80	
MMG-E 180M	180M	IE3	22	40.0 / 23.2	92.7	0.85	2960	11.14	
MMG-E 200LA	200LA	IE3	30	52.0 / 30.0	93.3	0.89	2950	7.22	
MMG-E 200LB	200LB	IE3	37	63.0 / 36.5	93.7	0.90	2950	7.65	
MMG-E 225M	225M	IE3	3 x 380-415 Δ / 660-690 Y	45	76/44	94.0	0.91	2970	9.05
MMG-E 250M	250M	IE3		55	94.0 / 54.5	94.3	0.89	2970	7.80
MMG-E 280S	280S	IE3		75	126 / 73.5	94.7	0.90	2960	8.14
MMG-E 280M	280M	IE3		90	150/87	95.0	0.91	2960	8.98
MMG-E 315S	315S	IE3		110	184/108	95.2	0.91	2980	8.87
MMG-E 315M	315M	IE3		132	220/128	95.4	0.91	2970	8.10
MMG-E 315LA	315LA	IE3		160	270/156	95.6	0.89	2980	8.43
MMG-E 315LB	315LB	IE3		200	335/195	95.8	0.90	2980	7.98
MMG-E 355M	355M	IE3		250	420/245	95.8	0.90	2980	7.92
MMG-E 355L	355L	IE3		315	517/298	95.8	0.91	2980	7.94
MMG-E 355L	355L	IE3	355	608/351	95.8	0.93	2980	8.71	

MMG-E, 4-pole

Motor	Frame size	IE class	Voltage [V]	P2 [kW]	I _{1/1} [A]	η [%]	Cos φ 1/1	n [min ⁻¹]	I _{start} / I _{1/1}
MMG-E 71A	71A	IE3	3 x 220-240 Δ / 380-415 Y	0.25	1.32 / 0.75	73.5	0.66	1480	5.07
MMG-E 71B	71B	IE3		0.37	1.88 / 1.08	77.3	0.64	1480	5.46
MMG-E 80A	80A	IE3		0.55	2.6 / 1.48	80.8	0.67	1440	6.62
MMG-E 80B	80B	IE3		0.75	3.3 / 1.9	82.5	0.69	1430	6.39
MMG-E 90S	90S	IE3		1.1	4.45 / 2.55	84.1	0.75	1440	7.67
MMG-E 90L	90L	IE3		1.5	6.10 / 3.50	85.3	0.73	1440	8.66
MMG-E 100LA	100LA	IE3		2.2	8.40 / 4.85	86.7	0.76	1450	8.89
MMG-E 100LB	100LB	IE3		3	6.35 / 3.70	87.7	0.78	1450	9.19
MMG-E 112M	112M	IE3		4	7.5 / 4.5	88.6	0.84	1450	7.32
MMG-E 132S	132S	IE3		5.5	10.6 / 6.15	89.6	0.86	1460	7.61
MMG-E 132M	132M	IE3	7.5	13.8 / 8	90.4	0.88	1460	7.32	
MMG-E 160M	160M	IE3	11	21.0 / 12.2	91.4	0.83	1480	9.55	
MMG-E 160L	160L	IE3	15	28.0 / 16.4	92.1	0.85	1470	8.87	
MMG-E 180M	180M	IE3	18.5	34 / 19.8	92.6	0.85	1480	2.54	
MMG-E 180L	180L	IE3	22	39.5 / 23.0	93.0	0.86	1480	8.00	
MMG-E 200L	200L	IE3	30	54.0 / 31.5	93.6	0.86	1475	7.92	
MMG-E 225S	225S	IE3	37	5.7 / 1.7	93.9	0.87	1480	7.73	
MMG-E 225M	225M	IE3	3 x 380-415 Δ / 660-690 Y	45	6.9 / 1.9	94.2	0.87	1485	8.34
MMG-E 250M	250M	IE3		55	94.0 / 54.5	94.6	0.89	1480	8.20
MMG-E 280S	280S	IE3		75	130/75	95.0	0.87	1485	8.44
MMG-E 280M	280M	IE3		90	154 / 89.5	95.6	0.89	1480	8.79
MMG-E 315S	315S	IE3		110	192/112	95.4	0.87	1480	7.34
MMG-E 315M	315M	IE3		132	232/136	95.6	0.86	1490	7.21
MMG-E 315LA	315LA	IE3		160	280/164	95.8	0.86	1490	6.97
MMG-E 315LB	315LB	IE3		200	350/204	96.0	0.87	1490	7.07
MMG-E 355M	355M	IE3		250	418/242	96.0	0.90	1490	6.22
MMG-E 355L	355L	IE3		315	525/305	96.0	0.91	1490	7.22

MMG-E, 6-pole

Motor	Frame size	IE class	Voltage [V]	P2 [kW]	I _{1/1} [A]	η [%]	Cos φ 1/1	n [min ⁻¹]	I _{start} / I _{1/1}
MMG-E	90S	IE3	3 x 220-240 Δ / 380-415 Y	0.75	3.03 / 1.75	78.9	0.76	970	4.30
MMG-E	90L	IE3		1.1	4.82 / 2.78	81.0	0.70	970	4.94
MMG-E	100L	IE3		1.5	6.44 / 3.72	82.5	0.69	970	5.80
MMG-E	112M	IE3		2.2	9.08 / 5.24	84.3	0.71	970	5.21
MMG-E	132S	IE3		3	12.5 / 7.23	85.6	0.69	980	6.04
MMG-E	132MA	IE3		4	9.99 / 5.77	86.8	0.70	980	6.12
MMG-E	132MB	IE3		5.5	13.41 / 7.74	88.0	0.70	980	6.42
MMG-E	160M	IE3		7.5	17.0 / 9.9	89.1	0.71	980	7.56
MMG-E	160L	IE3		11	24.6 / 14.4	90.3	0.71	980	8.05
MMG-E	180L	IE3		15	30.0 / 17.4	91.2	0.80	980	7.66
MMG-E	200LA	IE3	3 x 380-415 Δ / 660-690 Y	18.5	35.5 / 20.6	91.7	0.82	985	8.15
MMG-E	200LB	IE3		22	43.5 / 25.5	92.2	0.79	990	9.48
MMG-E	225M	IE3		30	58.35 / 33.7	92.9	0.81	990	5.52
MMG-E	250M	IE3		37	68.63 / 40.2	93.3	0.85	990	7.47
MMG-E	280S	IE3		45	88.4 / 51	93.7	0.78	990	7.07
MMG-E	280M	IE3		55	103 / 59.5	94.1	0.82	990	6.68
MMG-E	315S	IE3		75	131/76	94.6	0.87	990	6.59
MMG-E	315M	IE3		90	158.5 / 91.5	94.9	0.86	990	7.60

MMG-H3, 2-pole

Motor	Frame size	IE class	Voltage [V]	P2 [kW]	I _{1/1} [A]	η [%]	Cos φ 1/1	n [min ⁻¹]	I _{start} / I _{1/1}
MMG-H3	80B	IE3	3 x 220-240 Δ / 380-420 Y	0.75	3.05 - 2.80 / 1.76 - 1.60	80.7	0.8	2850	7.2
MMG-H3	80B	IE3		1.1	4.35 - 4.00 / 2.55 - 2.28	82.7	0.8	2850	7.2
MMG-H3	90SA	IE3	3 x 220-240 Δ / 380-420 Y	1.5	5.30 - 4.85 / 3.05 - 2.80	84.2	0.9	2900	7.9
MMG-H3	90LA	IE3		2.2	7.55 - 6.90 / 4.35 - 3.95	85.9	0.9	2900	8.0
MMG-H3	100LA	IE3	3 x 220-240 Δ / 380-420 Y	3	10.2 - 9.30 / 5.90 - 5.30	87.1	0.9	2910	8.9
MMG-H3	100LA	IE3		3	5.90 - 5.30 / 3.40 - 3.05	87.1	0.9	2910	8.9
MMG-H3	112MA	IE3	3 x 220-240 Δ / 380-420 Y	4	7.85 - 7.10 / 4.50 - 4.10	88.1	0.9	2910	7.6
MMG-H3	132SA	IE3		5.5	10.6 - 9.50 / 6.05 - 5.50	89.2	0.9	2920	8.5
MMG-H3	132SB	IE3	3 x 220-240 Δ / 380-420 Y	7.5	14.0 - 12.8 / 8.10 - 7.35	90.1	0.9	2920	8.5
MMG-H3	160MA	IE3		11	20.4 - 18.4 / 11.6 - 10.6	91.2	0.9	2940	7.6
MMG-H3	160MB	IE3	3 x 220-240 Δ / 380-420 Y	15	27.5 - 24.8 / 15.8 - 14.4	91.9	0.9	2940	7.7
MMG-H3	160L	IE3		18.5	33.5 - 30.5 / 19.2 - 17.6	92.4	0.9	2940	8.2
MMG-H3	180M	IE3	3 x 220-240 Δ / 380-420 Y	22	40.0 - 36.0 / 23.0 - 20.8	92.7	0.9	2950	8.7
MMG-H3	200LA	IE3		30	55.0 - 49.5 / 31.5 - 29.0	93.3	0.9	2960	9.0
MMG-H3	200LB	IE3	3 x 380-420 Δ / 660-725 Y	37	66.5 - 60.5 / 38.5 - 35.0	93.7	0.9	2960	9.0
MMG-H3	225MA	IE3		45	80.0 - 72.5 / 46.0 - 42.0	94.0	0.9	2960	8.3
MMG-H3	250MA	IE3	3 x 380-420 Δ / 660-725 Y	55	102 - 91.0 / 58.0 - 53.0	94.3	0.9	2970	7.2
MMG-H3	280SA	IE3		75	132-120 / 76.0 - 69.5	94.7	0.9	2970	8.0
MMG-H3	280MA	IE3	3 x 380-420 Δ / 660-725 Y	90	156-142 / 90.0 - 82.0	95.0	0.9	2970	8.1
MMG-H3	315SA	IE3		110	198-178 / 114-104	95.2	0.9	2980	6.7
MMG-H3	315MA	IE3	3 x 380-420 Δ / 660-725 Y	132	234-212 / 134-122	95.4	0.9	2980	6.5
MMG-H3	315LA	IE3		160	285-255 / 164-148	95.6	0.9	2980	6.6
MMG-H3	315LB	IE3	200	350-315 / 206-184	95.4	0.9	3575	6.1	

MMG-H3, 4-pole

Motor	Frame size	IE class	Voltage [V]	P2 [kW]	I _{1/1} [A]	η [%]	Cos φ 1/1	n [min ⁻¹]	I _{start} / I _{1/1}
MMG-H3	80B	IE3	3 x 220-240 Δ / 380-420 Y	0.75	3.25 - 3.00 / 1.90 - 1.72	82.5	0.7	1420	6.4
MMG-H3	90SA	IE3		1.1	4.40 - 4.05 / 2.55 - 2.30	84.1	0.8	1440	6.5
MMG-H3	90LA	IE3	3 x 220-240 Δ / 380-420 Y	1.5	5.85 - 5.35 / 3.40 - 3.05	85.3	0.8	1440	7.0
MMG-H3	100LA	IE3		2.2	8.20 - 7.55 / 4.75 - 4.30	86.7	0.8	1440	6.5
MMG-H3	100LB	IE3	3 x 220-240 Δ / 380-420 Y	3	11.0 - 10.2 / 6.40 - 5.80	87.7	0.8	1440	7.0
MMG-H3	100LB	IE3		3	6.40 - 5.80 / 3.70 - 3.35	87.7	0.8	1440	8.3
MMG-H3	112MA	IE3	3 x 220-240 Δ / 380-420 Y	4	8.45 - 7.65 / 4.85 - 4.45	88.6	0.8	1450	7.1
MMG-H3	132SA	IE3		5.5	11.6 - 10.4 / 6.65 - 6.05	89.6	0.8	1460	8.2
MMG-H3	132MA	IE3	3 x 220-240 Δ / 380-420 Y	7.5	15.4 - 14.0 / 8.85 - 8.05	90.4	0.8	1460	8.2
MMG-H3	160MA	IE3		11	21.2 - 19.2 / 12.2 - 11.2	91.4	0.9	1470	7.6
MMG-H3	160LA	IE3	3 x 220-240 Δ / 380-420 Y	15	28.5 - 25.5 / 16.4 - 14.8	92.1	0.9	1470	8.5
MMG-H3	180MA	IE3		18.5	35.0 - 31.5 / 20.0 - 18.2	92.6	0.9	1470	6.9
MMG-H3	180LA	IE3	3 x 220-240 Δ / 380-420 Y	22	41.5 - 37.5 / 23.8 - 21.8	93.0	0.9	1470	6.8
MMG-H3	200LA	IE3		30	56.0 - 50.5 / 32.0 - 29.5	93.6	0.9	1470	6.9
MMG-H3	225SA	IE3	3 x 380-420 Δ / 660-725 Y	37	69.0 - 62.5 / 39.5 - 36.0	93.9	0.9	1480	6.4
MMG-H3	225MA	IE3		45	84.5 - 76.5 / 48.5 - 44.0	94.2	0.9	1480	6.4
MMG-H3	250MA	IE3	3 x 380-420 Δ / 660-725 Y	55	102 - 91.5 / 58.0 - 53.0	94.6	0.9	1480	6.8
MMG-H3	280SA	IE3		75	140-126 / 80.5 - 73.0	95.0	0.9	1490	6.9
MMG-H3	280MA	IE3	3 x 380-420 Δ / 660-725 Y	90	166-150 / 95.0 - 86.5	95.2	0.9	1490	7.2
MMG-H3	315SA	IE3		110	202-182 / 116-106	95.4	0.9	1490	6.8
MMG-H3	315MA	IE3	3 x 380-420 Δ / 660-725 Y	132	242-218 / 140-126	95.6	0.9	1490	7.3
MMG-H3	315LA	IE3		160	285-260 / 164-150	95.8	0.9	1490	7.3
MMG-H3	315LB	IE3	200	355-320 / 204-186	96.0	0.9	1490	7.4	

Electrical data, MGE motors

Electrical data for motors with built-in frequency converter.

2-pole

Motor	Frame size	Voltage	P2 [kW]	I _{1/1} [A]
MGE	80B-IA	3 x 380-480 V	1.1	2.2 - 1.9
MGE	90SC-IA		1.5	2.9 - 2.4
MGE	90LD-IA		2.2	4.15 - 3.4
MGE	100LA-JA		3	5.8 - 4.8
MGE	112MC-JA		4	7.6 - 6.2
MGE	132SE-JA		5.5	10.3 - 8.2
MGE	132SF-JA		7.5	14.1 - 11.2
MGE	160MH-JA		11	20.3 - 16.0
MGE	160MD-F		15	30.0 - 26.0
MGE	160LB-F		18.5	37.0 - 31.0
MGE	180MB-F	22	43.5 - 35.0	

4-pole

Motor	Frame size	Voltage	P2 [kW]	I _{1/1} [A]
MGE	80B-IA	3 x 380-480 V	0.55	1.2 - 1.1
MGE	80C-IA		0.75	1.55 - 1.4
MGE	90SD-IA		1.1	2.2 - 1.9
MGE	90LD-IA		1.5	2.9 - 2.5
MGE	100LB-JA		2.2	4.3 - 3.6
MGE	100LD-JA		3	5.8 - 4.6
MGE	112ME-JA		4	7.7 - 6.0
MGE	132SG-JA		5.5	10.5 - 8.40
MGE	132MH-JA		7.5	14.1 - 11.1
MGE	160MB-F		11	22.0 - 17.8
MGE	160LB-F		15	30.0 - 25.4
MGE	180MA-F		18.5	37.0 - 30.0

Pump dimensions with other motors

The tables below show changes of pump dimensions when using other motors than the standard motors listed in section [17. Dimensional drawings and technical data](#).

IE class	Motor
IE1	MMG-G
	MMG-E
IE2	MMG-G
	MMG-H
IE3	Siemens
	MMG-E
	MMG-H

Example

If a 2-pole, 3 kW MMG-G motor, class IE1, is selected, the LL dimension will be 17 mm bigger.

IE1

IE1, MMG-G, 2-pole

P2 [kW]		Motors on data pages		Other motors		L/LB	H	h4/AD	AG	LL	P	A	B	C	K	Weight [kg]	
50 Hz	60 Hz	Motor	Frame size	Motor	Frame size	[mm]										NK	NB
0.55	0.55	MG-C	71B	MMG-G	71	29.5	0	23	-37	-2	0	0	0	0	0	5.5	5.2
0.75	0.75	MG-H3	80A	MMG-G	80	11.5	0	49	-22	-2	0	0	0	0	0	6.2	5.3
1.1	1.1	MG-H3	80C	MMG-G2	80	-8.5	0	49	-22	-2	0	0	0	0	0	8.1	7
1.5	1.5	MG-H3	90S	MMG-G2	90S	-23.5	0	60	-102	-23	0	0	0	0	0	5.5	4.5
2.2	2.2	MG-H3	90L	MMG-G2	90L	-38.5	0	60	-102	-23	0	0	0	0	0	6.5	5.5
3	3	MG-H3	100L	MMG-G2	100L	-20.5	0	60	-72	17	0	0	0	0	0	12	10
4	4	MG-H3	112M	MMG-G2	112M	-40.5	0	55	-112	17	0	0	0	0	0	2	1
5.5	5.5	MG-H3	132S	MMG-G2	132S	-17	0	91	-112	37	0	0	0	0	0	25	23
7.5	7.5	MG-H3	132S	MMG-G2	132S	-5	0	66	-113	5	0	0	0	0	0	19	16
11	11	MG-H3	160M	MMG-G2	160M	27	0	59	-153	-48	0	0	0	0	-0.5	22	16
15	15	MG-H3	160M	MMG-G2	160M	27	0	59	-153	-48	0	0	0	0	-0.5	24	17
18.5	18.5	MG-H3	160L	MMG-G2	160L	27	0	59	-153	-48	0	0	0	0	-0.5	26	20
22	22	MG-H3	180M	MMG-G2	180M	21	0	101	-143	-81	0	0	0	0	-0.5	59	52
30	30	Siemens IE3	200L	MMG-G2	200L	49	0	59	-165	-7	0	0	0	0	-0.5	60	30
37	37	Siemens IE3	200L	MMG-G2	200L	24	0	59	-165	-7	0	0	0	0	-0.5	50	25
45	45	Siemens IE3	225M	MMG-G2	225M	-7	0	89	-125	-7	0	0	25	0	-0.5	25	15
55	55	Siemens IE3	250M	MMG-G2	250S	-4.5	0	83	-143	-3	0	0	-38	0	0	65	45
75	75	Siemens IE3	280S	MMG-G2	250M	-39.5	-30	60	-143	-3	0	-51	-19	-22	0	15	-5
90	90	Siemens IE3	280M	MMG-G	280S	-78	0	90	-145	-3	0	0	0	0	0	10	-10
110	110	Siemens IE3	315S	MMG-G	280M	-10	-35	8	-200	-69	-110	-51	13	-26	-4	-140	-70
132	132	Siemens IE3	315M	MMG-G	315S	-131	0	33	-195	1	0	0	-51	0	0	20	20
160	160	Siemens IE3	315L	MMG-G	315M	-80	0	33	-195	1	0	0	0	0	0	220	200
200	200	Siemens IE3	315L	MMG-G	315M	-235	0	33	-195	1	0	0	0	0	0	170	210
250	250	Siemens IE3	315L	MMG-G	355M	128	40	150	-	-	-	102	52	38	0	810	810
315	315	Siemens IE3	315L	MMG-G	355L	128	40	150	-	-	-	102	122	38	0	745	745

Note: The dimensions L and h4 refer to NK pumps, LB and AD to NB pumps.

IE1, MMG-G, 4-pole

P2 [kW]		Motors on data pages		Other motors		L/LB	H	h4/AD	AG	LL	P	A	B	C	K	Weight [kg]		
50 Hz	60 Hz	Motor	Frame size	Motor	Frame size	[mm]											NK	NB
0.25	0.25	MG-C	71B	MMG-G	63	5	-8	13	-32	-2	0	-12	-10	-5	0	5.8	5.5	
0.37	0.37	MG-C	71B	MMG-G	71	29.5	0	23	-37	-2	0	0	0	0	0	5.3	5	
0.55	0.55	MG-C	80A	MMG-G	80	11.5	0	49	-22	-2	0	0	0	0	0	5.7	4.9	
0.75	0.75	MG-H3	90S	MMG-G	80	-38.5	-10	48	-102	-23	0	-15	0	-6	0	7.5	7	
1.1	1.1	MG-H3	90S	MMG-G2	90S	-23.5	0	60	-102	-23	0	0	0	0	0	-0.4	-1.4	
1.5	1.5	MG-H3	90L	MMG-G2	90L	-38.5	0	60	-102	-23	0	0	0	0	0	2.5	1.5	
2.2	2.2	MG-H3	100L	MMG-G2	100L	-20.5	0	60	-72	17	0	0	0	0	0	10	5	
3	3	MG-H3	100L	MMG-G2	100L	-20.5	0	60	-72	17	0	0	0	0	0	9	7	
4	4	MG-H3	112M	MMG-G2	112M	-40.5	0	55	-112	17	0	0	0	0	0	0	-1	
5.5	5.5	MG-H3	132S	MMG-G2	132S	-5	0	66	-113	5	0	0	0	0	0	7	7	
7.5	7.5	MG-H3	132M	MMG-G2	132M	-17	0	66	-113	5	0	-1	0	0	0	9	5	
11	11	MG-H3	160M	MMG-G2	160M	-47	0	59	-153	-48	0	0	-44	0	-0.5	21	14	
15	15	MG-H3	160L	MMG-G2	160L	-33	0	59	-153	-48	0	0	0	0	-0.5	15	9	
18.5	18.5	Siemens IE3	180M	MMG-G2	180M	4	0	19	-89	-32	0	0	0	0	-0.5	12	7	
22	22	Siemens IE3	180L	MMG-G2	180L	12	0	19	-89	-32	0	0	38	0	-0.5	35	25	
30	30	Siemens IE3	200L	MMG-G2	200L	24	0	59	-165	-7	0	0	0	0	-0.5	50	40	
37	37	Siemens IE3	225S	MMG-G2	225S	28	0	89	-125	-7	0	0	0	0	-0.5	40	25	
45	45	Siemens IE3	225M	MMG-G2	225M	-7	0	89	-125	-7	0	0	25	0	-0.5	30	15	
55	55	Siemens IE3	250M	MMG-G2	250S	-4.5	0	83	-143	-3	0	0	-38	0	0	55	35	
75	75	Siemens IE3	280S	MMG-G2	250M	-39.5	-30	60	-143	-3	0	-51	-19	-22	0	-10	-40	
90	90	Siemens IE3	280M	MMG-G2	280S	-78	0	90	-145	-3	0	0	0	0	0	-10	-30	
110	110	Siemens IE3	315S	MMG-G	280M	-10	-35	8	-200	-69	-110	-51	13	-26	-4	-45	-70	
132	132	Siemens IE3	315M	MMG-G	315S	-131	0	33	-195	1	0	0	-51	0	0	-30	-70	
160	160	Siemens IE3	315L	MMG-G	315M	-80	0	33	-195	1	0	0	0	0	0	200	180	
200	200	Siemens IE3	315L	MMG-G	315M	-235	0	33	-195	1	0	0	0	0	0	60	60	
250	250	Siemens IE3	315L	MMG-G	355M	128	40	150	-	-	-	102	52	38	-7	830	830	
315	315	Siemens IE3	315L	MMG-G	355L	-16	40	150	-	-	-	102	122	38	-7	620	620	

Note: The dimensions L and h4 refer to NK pumps, LB and AD to NB pumps.

IE1, MMG-G, 6-pole

P2 [kW]		Motors on data pages		Other motors		L/LB	H	h4/AD	AG	LL	P	A	B	C	K	Weight [kg]		
50 Hz	60 Hz	Motor	Frame size	Motor	Frame size	[mm]											NK	NB
0.37	0.37	Siemens	80A	MMG-G	80	8.5	0	38	-15	5	0	0	0	0	0.5	7	7	
0.55	0.55	Siemens	80B	MMG-G	80	8.5	0	38	-15	5	0	0	0	0	0.5	7	7	
0.75	0.75	Siemens IE3	90S	MMG-G	90S	-34.5	0	44	-33	1	0	0	0	0	0	5.5	5.5	
1.1	1.1	Siemens IE3	90L	MMG-G2	90L	-54.5	0	44	-33	1	0	0	0	0	0	6	6	
1.5	1.5	Siemens IE3	100L	MMG-G2	100L	-21.5	0	14	-45	8	0	0	0	0	0	7	7	
2.2	2.2	Siemens IE3	112M	MMG-G2	112M	-22.5	0	12	-45	8	0	0	0	0	0	6	6	
3	3	Siemens IE3	132S	MMG-G2	132S	-11	0	23	-65	10	0	0	0	0	0	8	3	
4	4	Siemens IE3	132M	MMG-G2	132M	27	0	23	-65	10	0	-1	0	0	0	13	8	
5.5	5.5	Siemens IE3	132M	MMG-G2	132M	-23	0	23	-65	10	0	-1	38	0	0	28	11	
7.5	7.5	Siemens IE3	160M	MMG-G2	160M	4	0	26.5	-85	20	0	0	0	0	-0.5	21	12	
11	11	Siemens IE3	160L	MMG-G2	160L	-12	0	26.5	-85	20	0	0	0	0	-0.5	29	20	
15	15	Siemens IE3	180L	MMG-G2	180L	12	0	19	-89	-32	0	0	38	0	-0.5	45	45	
18.5	18.5	Siemens IE3	200L	MMG-G2	200L	49	0	59	-165	-7	0	0	0	0	-0.5	60	52	
22	22	Siemens IE3	200L	MMG-G2	200L	24	0	59	-165	-7	0	0	0	0	-0.5	45	45	
30	30	Siemens IE3	225M	MMG-G2	225M	-7	0	89	-125	-7	0	0	25	0	-0.5	20	5	
37	37	Siemens IE3	250M	MMG-G2	250S	-4.5	0	83	-143	-3	0	0	-38	0	0	0	-20	
45	45	Siemens IE3	280S	MMG-G2	250M	-39.5	-30	60	-143	-3	0	-51	-19	-22	0	-70	-90	
55	55	Siemens IE3	280M	MMG-G2	280S	32	0	90	-145	-3	0	0	0	0	0	50	30	
75	75	Siemens IE3	315S	MMG-G2	280M	-10	-35	8	-200	-69	-110	-51	13	-26	-4	-70	-70	
90	90	Siemens IE3	315M	MMG-G	315S	-131	0	33	-195	1	0	0	-51	0	0	-40	-50	
110	110	Siemens IE3	315L	MMG-G	315M	-80	0	33	-195	1	0	0	0	0	0	0	-20	
132	132	Siemens IE3	315L	MMG-G	315M	-235	0	33	-195	1	0	0	0	0	0	-20	-40	

Note: The dimensions L and h4 refer to NK pumps, LB and AD to NB pumps.

IE2

IE2, MMG-E, 2-pole

P2 [kW]		Motors on data pages				Other motors		L/LB	H	h4/AD	AG	LL	P	A	B	C	K	Weight [kg]		
50 Hz	60 Hz	Motor	Frame size	Motor	Frame size	[mm]													NK	NB
0.75	0.75	MG-C	71B	MMG-E1	80A	24	0	31	10	13	-80	0	0	0	0	0	0	7.6	7.7	
1.1	1.1	MG-H3	80A	MMG-E1	80B	4	0	31	10	13	0	0	0	0	0	0	0	8.5	8.4	
1.5	1.5	MG-H3	80C	MMG-E1	90S	-11	0	50	-56	21	1	0	0	0	0	0	4	5		
2.2	2.2	MG-H3	90S	MMG-E1	90L	-26	0	50	-56	21	1	0	0	0	0	0	4	5		
3	3	MG-H3	90L	MMG-E1	100L	-10	0	60	-56	-12	0	0	0	0	0	0	11	11		
4	4	MG-H3	100L	MMG-E1	112M	-32	0	54	-84	-2	0	0	0	0	-10	0	3	4		
5.5	5.5	MG-H3	112M	MMG-E1	132SA	-1	0	76	-84	-20	0	0	0	0	0	0	25	23		
7.5	7.5	MG-H3	132S	MMG-E1	132SB	11	0	51	-85	-20	0	0	0	0	0	0	21	18		
11	11	MG-H3	132S	MMG-E1	160MA	40	0	48	-82	6	0	0	0	0	0	0	34	37		
15	15	MG-H3	160M	MMG-E1	160MB	40	0	48	-82	6	0	0	0	0	0	0	36	38		
18.5	18.5	MG-H3	160M	MMG-E1	160L	-4	0	48	-82	6	0	0	0	0	0	0	44	45		
22	22	MG-H3	160L	MMG-E1	180M	39	0	81	-82	-13	0	0	38	0	0	0	60	60		
30	30	MG-H3	180M	MMG-E1	200LA	49	0	-5	-36	-8	0	0	0	0	0	0	23	8		
37	37	Siemens IE3	200L	MMG-E1	200LB	24	0	-5	-36	-8	0	0	0	0	0	0	10	0		
45	45	Siemens IE3	200L	MMG-E1	225M	2	0	-3	-38	-9	1	0	25	0	0	0	-14	-5		
55	55	Siemens IE3	225M	MMG-E1	250M	28	0	-40	-73	-17	0	0	0	0	0	0	20	23		
75	75	Siemens IE3	250M	MMG-E1	280S	10	0	-38	-73	-17	0	0	0	0	0	0	32	34		
90	90	Siemens IE3	280S	MMG-E1	280M	-50	0	-38	-73	-17	0	0	51	0	0	0	3	5		
110	110	Siemens IE3	280M	MMG-E1	315S	188	0	-10	-54	-19	0	0	0	0	0	0	65	170		
132	132	Siemens IE3	315S	MMG-E1	315M	163	0	15	-54	-19	0	0	0	0	0	0	110	145		
160	160	Siemens IE3	315M	MMG-E1	315LA	163	0	15	-54	-19	0	0	0	0	0	0	135	150		
200	200	Siemens IE3	315L	MMG-E1	315LB	8	0	15	-54	-19	0	0	0	0	0	0	-25	20		
250	250	Siemens IE3	315L	MMG-E1	355M	218	40	155	154	23	-140	102	52	38	0	0	370	420		
315	315	Siemens IE3	315L	MMG-E1	355L	368	40	155	154	23	-140	102	52	38	0	0	415	465		

Note: The dimensions L and h4 refer to NK pumps, LB and AD to NB pumps.

IE2, MMG-E, 4-pole

P2 [kW]		Motors on data pages				Other motors		L/LB	H	h4/AD	AG	LL	P	A	B	C	K	Weight [kg]		
50 Hz	60 Hz	Motor	Frame size	Motor	Frame size	[mm]													NK	NB
0.25	0.25	MG-C	71B	MMG-E1	71A	34	0	15	10	78	-68	0	0	0	0	0	4.8	5.5		
0.37	0.37	MG-C	71B	MMG-E1	71B	34	0	15	10	78	-68	0	0	0	0	0	5.3	6		
0.55	0.55	MG-C	71B	MMG-E1	80A	24	0	31	10	118	-108	0	0	0	0	0	7.7	7.9		
0.75	0.75	MG-C	80A	MMG-E1	80MB	-26	-10	30	-70	13	0	-15	0	-6	0	0	8	7.5		
1.1	1.1	MG-H3	90S	MMG-E1	90S	14	0	50	-54	23	0	0	0	0	0	0	6	7		
1.5	1.5	MG-H3	90S	MMG-E1	90L	-26	0	50	-54	23	0	0	-25	0	0	0	9	10		
2.2	2.2	MG-H3	90L	MMG-E1	100LA	-10	0	60	-54	-10	0	0	0	0	0	0	11	8		
3	3	MG-H3	100L	MMG-E1	100LB	-10	0	60	-54	-10	0	0	0	0	0	0	14	14		
4	4	MG-H3	100L	MMG-E1	112M	38	0	56	-84	-2	0	0	0	0	0	0	14	15		
5.5	5.5	MG-H3	112M	MMG-E1	132S	11	0	51	-85	-20	1	0	0	0	0	0	17	19		
7.5	7.5	MG-H3	132S	MMG-E1	132M	1	0	51	-85	-20	1	0	0	0	0	0	14	12		
11	11	MG-H3	132M	MMG-E1	160M	-47	0	48	-82	6	0	0	-44	0	0	0	31	26		
15	15	MG-H3	160M	MMG-E1	160L	-33	0	48	-82	6	0	0	0	0	0	0	25	21		
18.5	18.5	MG-H3	160L	MMG-E1	180M	22	0	-11	-28	-13	0	0	0	0	0	0	23	28		
22	22	Siemens IE3	180M	MMG-E1	180L	42	0	-11	-28	-13	0	0	38	0	0	0	31	32		
30	30	Siemens IE3	180L	MMG-E1	200L	24	0	-5	-36	-8	0	0	0	0	0	0	35	30		
37	37	Siemens IE3	200L	MMG-E1	225S	32	0	-28	-38	-9	1	0	0	0	0	0	29	32		
45	45	Siemens IE3	225S	MMG-E1	225M	-3	0	-3	-37	-8	0	0	25	0	0	0	10	13		
55	55	Siemens IE3	225M	MMG-E1	250M	28	0	-40	-73	-17	0	0	0	0	0	0	22	25		
75	75	Siemens IE3	250M	MMG-E1	280S	10	0	-38	-73	-17	0	0	0	0	0	0	-1	-10		
90	90	Siemens IE3	280S	MMG-E1	280M	-50	0	-38	-73	-17	0	0	51	0	0	0	9	10		
110	110	Siemens IE3	280M	MMG-E1	315S	188	0	-10	-54	-19	0	0	0	0	0	0	160	170		
132	132	Siemens IE3	315S	MMG-E1	315M	133	0	15	-54	-19	0	0	0	0	0	0	95	90		
160	160	Siemens IE3	315M	MMG-E1	315LA	133	0	15	-54	-19	0	0	0	0	0	0	135	150		
200	200	Siemens IE3	315L	MMG-E1	315LB	-22	0	15	-54	-19	0	0	0	0	0	0	105	110		
250	250	Siemens IE3	315L	MMG-E1	355M	148	40	155	154	23	0	102	52	38	-7	0	400	450		

Note: The dimensions L and h4 refer to NK pumps, LB and AD to NB pumps.

IE2, MMG-E, 6-pole

P2 [kW]		Motors on data pages		Other motors		L/LB	H	h4/AD	AG	LL	P	A	B	C	K	Weight [kg]		
50 Hz	60 Hz	Motor	Frame size	Motor	Frame size	[mm]											NK	NB
0.75	0.75	Siemens IE3	80B	MMG-E1	90S	-2	0	34	15	23	0	0	0	0	0	7	13	
1.1	1.1	Siemens IE3	90S	MMG-E1	90L	-42	0	34	15	23	0	0	-25	0	0	6	11	
1.5	1.5	Siemens IE3	90L	MMG-E1	100L	-11	0	14	-27	-10	0	0	0	0	0	7	14	
2.2	2.2	Siemens IE3	100L	MMG-E1	112M	56	0	13	-17	-2	0	0	0	0	0	8	13	
3	3	Siemens IE3	112M	MMG-E1	132S	5	0	8	-37	-20	1	0	0	0	0	8	11	
4	4	Siemens IE3	132S	MMG-E1	132MA	45	0	8	-37	-20	1	0	0	0	0	17	18	
5.5	5.5	Siemens IE3	132M	MMG-E1	132MB	-5	0	8	-37	-20	1	0	38	0	0	26	19	
7.5	7.5	Siemens IE3	132M	MMG-E1	160M	4	0	15.5	-14	6	0	0	0	0	0	33	34	
11	11	Siemens IE3	160M	MMG-E1	160L	-12	0	15.5	-14	6	0	0	0	0	0	24	25	
15	15	Siemens IE3	160L	MMG-E1	180L	42	0	-11	-28	-13	0	0	38	0	0	6	16	
18.5	18.5	Siemens IE3	180L	MMG-E1	200LA	49	0	-5	-36	-8	0	0	0	0	0	30	32	
22	22	Siemens IE3	200L	MMG-E1	200LB	24	0	-5	-36	-8	0	0	0	0	0	15	25	
30	30	Siemens IE3	200L	MMG-E1	225M	-3	0	-3	-37	-8	0	0	25	0	0	-20	-25	
37	37	Siemens IE3	225M	MMG-E1	250M	28	0	-40	-73	-17	0	0	0	0	0	-20	3	
45	45	Siemens IE3	250M	MMG-E1	280S	10	0	-38	-73	-17	0	0	0	0	0	-9	12	
55	55	Siemens IE3	280S	MMG-E1	280M	60	0	-38	-73	-17	0	0	51	0	0	10	32	
75	75	Siemens IE3	280M	MMG-E1	315S	188	0	15	-54	-19	0	0	0	0	0	65	75	
90	90	Siemens IE3	315S	MMG-E1	315M	133	0	15	-54	-19	0	0	0	0	0	50	50	

Note: The dimensions L and h4 refer to NK pumps, LB and AD to NB pumps.

IE2, MMG-G, 2-pole

P2 [kW]		Motors on data pages		Other motors		L/LB	H	h4/AD	AG	LL	P	A	B	C	K	Weight [kg]		
50 Hz	60 Hz	Motor	Frame size	Motor	Frame size	[mm]											NK	NB
0.55	0.55	MG-C	71B	MMG-GA	71	29.5	0	23	-37	-2	0	0	0	0	0	7.9	7.6	
0.75	0.75	MG-H3	80A	MMG-GA	80	11.5	0	49	-22	-2	0	0	0	0	0	8.6	7.7	
1.1	1.1	MG-H3	80C	MMG-G1	80	-8.5	0	49	-22	-2	0	0	0	0	0	7.5	6.4	
1.5	1.5	MG-H3	90S	MMG-G1	90S	-23.5	0	60	-102	-23	0	0	0	0	0	5	4	
2.2	2.2	MG-H3	90L	MMG-G1	90L	-38.5	0	60	-102	-23	0	0	0	0	0	5	4	
3	3	MG-H3	100L	MMG-G1	100L	-20.5	0	60	-72	17	0	0	0	0	0	12	10	
4	4	MG-H3	112M	MMG-G1	112M	-40.5	0	55	-112	17	0	0	0	0	0	4	3	
5.5	5.5	MG-H3	132S	MMG-G1	132S	-17	0	91	-112	37	0	0	0	0	0	35	33	
7.5	7.5	MG-H3	132S	MMG-G1	132S	-5	0	66	-113	5	0	0	0	0	0	24	21	
11	11	MG-H3	160M	MMG-G1	160M	27	0	59	-153	-48	0	0	0	0	-0.5	44	38	
15	15	MG-H3	160M	MMG-G1	160M	27	0	59	-153	-48	0	0	0	0	-0.5	32	25	
18.5	18.5	MG-H3	160L	MMG-G1	160L	27	0	59	-153	-48	0	0	0	0	-0.5	46	40	
22	22	MG-H3	180M	MMG-G1	180M	21	0	101	-143	-81	0	0	0	0	-0.5	53	46	
30	30	Siemens IE3	200L	MMG-G1	200L	49	0	59	-165	-7	0	0	0	0	-0.5	70	40	
37	37	Siemens IE3	200L	MMG-G1	200L	24	0	59	-165	-7	0	0	0	0	-0.5	40	15	
45	45	Siemens IE3	225M	MMG-G1	225M	-7	0	89	-125	-7	0	0	25	0	-0.5	35	25	
55	55	Siemens IE3	250M	MMG-G1	250S	-4.5	0	83	-143	-3	0	0	-38	0	0	85	65	
75	75	Siemens IE3	280S	MMG-G1	250M	-39.5	-30	60	-143	-3	0	-51	-19	-22	0	30	10	
90	90	Siemens IE3	280M	MMG-GA	280S	-78	0	90	-145	-3	0	0	0	0	0	40	20	
110	110	Siemens IE3	315S	MMG-GA	280M	-10	-35	8	-200	-69	-110	-51	13	-26	-4	-140	-70	
132	132	Siemens IE3	315M	MMG-GA	315S	-131	0	33	-195	1	0	0	-51	0	0	-60	-60	
160	160	Siemens IE3	315L	MMG-GA	315M	-80	0	33	-195	1	0	0	0	0	0	-35	-55	
200	200	Siemens IE3	315L	MMG-GA	315M	-235	0	33	-195	1	0	0	0	0	0	190	230	
250	250	Siemens IE3	315L	MMG-GA	315CA	379	0	166	-	-	-	0	202	0	0	410	-	
315	315	Siemens IE3	315L	MMG-GA	315DA	579	0	166	-	-	-	0	402	0	0	645	-	
355	355	Siemens IE3	355L	MMG-GA	355AA	249	0	171	-	-	-	-20	-90	54	-5	300	-	

Note: The dimensions L and h4 refer to NK pumps, LB and AD to NB pumps.

IE2, MMG-G, 4-pole

P2 [kW]		Motors on data pages		Other motors		L/LB	H	h4/AD	AG	LL	P	A	B	C	K	Weight [kg]		
50 Hz	60 Hz	Motor	Frame size	Motor	Frame size	[mm]											NK	NB
0.25	0.25	MG-C	71B	MMG-GA	63	5	-8	13	-32	-2	0	-12	-10	-5	0	5.8	5.5	
0.37	0.37	MG-C	71B	MMG-GA	71	29.5	0	23	-37	-2	0	0	0	0	0	5.3	5	
0.55	0.55	MG-C	80A	MMG-GA	80	11.5	0	49	-22	-2	0	0	0	0	0	6.7	5.9	
0.75	0.75	MG-H3	90S	MMG-GA	80	-38.5	-10	48	-102	-23	0	-15	0	-6	0	7.5	7	
1.1	1.1	MG-H3	90S	MMG-G1	90S	-23.5	0	60	-102	-23	0	0	0	0	0	1	0	
1.5	1.5	MG-H3	90L	MMG-G1	90L	-38.5	0	60	-102	-23	0	0	0	0	0	4	3	
2.2	2.2	MG-H3	100L	MMG-G1	100L	-20.5	0	60	-72	17	0	0	0	0	0	13	8	
3	3	MG-H3	100L	MMG-G1	100L	-20.5	0	60	-72	17	0	0	0	0	0	8	6	
4	4	MG-H3	112M	MMG-G1	112M	-40.5	0	55	-112	17	0	0	0	0	0	3	2	
5.5	5.5	MG-H3	132S	MMG-G1	132S	-5	0	66	-113	5	0	0	0	0	0	19	19	
7.5	7.5	MG-H3	132M	MMG-G1	132M	-17	0	66	-113	5	0	-1	0	0	0	14	10	
11	11	MG-H3	160M	MMG-G1	160M	-47	0	59	-153	-48	0	0	-44	0	-0.5	35	28	
15	15	MG-H3	160L	MMG-G1	160L	-33	0	59	-153	-48	0	0	0	0	-0.5	41	35	
18.5	18.5	Siemens IE3	180M	MMG-G1	180M	4	0	19	-89	-32	0	0	0	0	-0.5	6	1	
22	22	Siemens IE3	180L	MMG-G1	180L	12	0	19	-89	-32	0	0	38	0	-0.5	35	25	
30	30	Siemens IE3	200L	MMG-G1	200L	24	0	59	-165	-7	0	0	0	0	-0.5	50	40	
37	37	Siemens IE3	225S	MMG-G1	225S	28	0	89	-125	-7	0	0	0	0	-0.5	35	20	
45	45	Siemens IE3	225M	MMG-G1	225M	-7	0	89	-125	-7	0	0	25	0	-0.5	40	25	
55	55	Siemens IE3	250M	MMG-G1	250S	-4.5	0	83	-143	-3	0	0	-38	0	0	90	70	
75	75	Siemens IE3	280S	MMG-G1	250M	-39.5	-30	60	-143	-3	0	-51	-19	-22	0	5	-25	
90	90	Siemens IE3	280M	MMG-GA	280S	-78	0	90	-145	-3	0	0	0	0	0	10	-10	
110	110	Siemens IE3	315S	MMG-GA	280M	-10	-35	8	-200	-69	-110	-51	13	-26	-4	-5	-30	
132	132	Siemens IE3	315M	MMG-GA	315S	-131	0	33	-195	1	0	0	-51	0	0	-20	-60	
160	160	Siemens IE3	315L	MMG-GA	315M	-80	0	33	-195	1	0	0	0	0	0	20	0	
200	200	Siemens IE3	315L	MMG-GA	315M	-235	0	33	-195	1	0	0	0	0	0	80	80	
250	250	Siemens IE3	315L	MMG-GA	315CB	244	0	166	-	-	-	0	202	0	-7	430	-	
315	315	Siemens IE3	315L	MMG-GA	315DB	300	0	166	-	-	-	0	402	0	-7	220	-	
355	355	Siemens IE3	355L	MMG-GA	355AB	114	0	171	-	-	-	-20	-90	54	-5	-	-	

Note: The dimensions L and h4 refer to NK pumps, LB and AD to NB pumps.

IE2, MMG-G, 6-pole

P2 [kW]		Motors on data pages		Other motors		L/LB	H	h4/AD	AG	LL	P	A	B	C	K	Weight [kg]		
50 Hz	60 Hz	Motor	Frame size	Motor	Frame size	[mm]											NK	NB
0.37	0.37	Siemens	80A	MMG-GA	80	8.5	0	38	-15	5	0	0	0	0	0.5	8	8	
0.55	0.55	Siemens	80B	MMG-GA	80	8.5	0	38	-15	5	0	0	0	0	0.5	9	9	
0.75	0.75	Siemens IE3	90S	MMG-GA	90S	-39.5	0	46	-33	1	0	0	0	0	0	5	5	
1.1	1.1	Siemens IE3	90L	MMG-G1	90L	-54.5	0	44	-33	1	0	0	0	0	0	6	6	
1.5	1.5	Siemens IE3	100L	MMG-G1	100L	-21.5	0	14	-45	8	0	0	0	0	0	9	9	
2.2	2.2	Siemens IE3	112M	MMG-G1	112M	-22.5	0	12	-45	8	0	0	0	0	0	11	11	
3	3	Siemens IE3	132S	MMG-G1	132S	-11	0	23	-65	10	0	0	0	0	0	23	18	
4	4	Siemens IE3	132M	MMG-G1	132M	27	0	23	-65	10	0	-1	0	0	0	30	25	
5.5	5.5	Siemens IE3	132M	MMG-G1	132M	-23	0	23	-65	10	0	-1	38	0	0	30	13	
7.5	7.5	Siemens IE3	160M	MMG-G1	160M	4	0	26.5	-85	20	0	0	0	0	-0.5	37	28	
11	11	Siemens IE3	160L	MMG-G1	160L	-12	0	26.5	-85	20	0	0	0	0	-0.5	43	34	
15	15	Siemens IE3	180L	MMG-G1	180L	12	0	19	-89	-32	0	0	38	0	-0.5	40	40	
18.5	18.5	Siemens IE3	200L	MMG-G1	200L	49	0	59	-165	-7	0	0	0	0	-0.5	70	62	
22	22	Siemens IE3	200L	MMG-G1	200L	24	0	59	-165	-7	0	0	0	0	-0.5	45	45	
30	30	Siemens IE3	225M	MMG-G1	225M	-7	0	89	-125	-7	0	0	25	0	-0.5	35	20	
37	37	Siemens IE3	250M	MMG-G1	250S	-4.5	0	83	-143	-3	0	0	-38	0	0	105	85	
45	45	Siemens IE3	280S	MMG-G1	250M	-39.5	-30	60	-143	-3	0	-51	-19	-22	0	55	35	
55	55	Siemens IE3	280M	MMG-G1	280S	32	0	90	-145	-3	0	0	0	0	0	90	70	
75	75	Siemens IE3	315S	MMG-G1	280M	-10	-35	8	-200	-69	-110	-51	13	-26	-4	-50	-50	
90	90	Siemens IE3	315M	MMG-GA	315S	-131	0	33	-195	1	0	0	-51	0	0	10	0	
110	110	Siemens IE3	315L	MMG-GA	315M	-80	0	33	-195	1	0	0	0	0	0	20	0	
132	132	Siemens IE3	315L	MMG-GA	315M	-235	0	33	-195	1	0	0	0	0	0	-80	-100	

Note: The dimensions L and h4 refer to NK pumps, LB and AD to NB pumps.

IE2, MMG-H2, 2-pole

P2 [kW]		Motors on data pages		Other motors		L/LB	H	h4/AD	AG	LL	P	A	B	C	K	Weight [kg]		
50 Hz	60 Hz	Motor	Frame size	Motor	Frame size	[mm]											NK	NB
0.55	0.55	MG-C	71B	MMG-H2	71B	22	0	0	21	21	0	0	0	0	0	-0.8	-1.1	
0.75	0.75	MG-H3	80A	MMG-H2	80B	29	0	21	28	28	0	0	0	0	0	2.6	1.7	
1.1	1.1	MG-H3	80C	MMG-H2	80B	9	0	21	28	28	0	0	0	0	0	3.5	2.4	
1.5	1.5	MG-H3	90S	MMG-H2	90SA	-24	0	35	-47	7	0	0	0	0	0	0	-1	
2.2	2.2	MG-H3	90L	MMG-H2	90LA	-39	0	35	-47	7	0	0	0	0	0	-1	-2	
3	3	MG-H3	100L	MMG-H2	100LA	-20	0	35	-47	12	0	0	0	0	0	1	-1	
4	4	MG-H3	112M	MMG-H2	112MA	-47	0	34	-87	12	0	0	0	0	0	-14	-15	
5.5	5.5	MG-H3	132S	MMG-H2	132SA	-41	0	54	-64	35	0	0	0	0	0	0	-2	
7.5	7.5	MG-H3	132S	MMG-H2	132SB	9	0	29	-65	3	0	0	38	0	0	-8	-11	
11	11	MG-H3	160M	MMG-H2	160MA	33	0	45	-73	-3	0	0	0	0	0	23	17	
15	15	MG-H3	160M	MMG-H2	160MB	33	0	45	-73	-3	0	0	0	0	0	21	14	
18.5	18.5	MG-H3	160L	MMG-H2	160L	33	0	45	-73	-3	0	0	0	0	0	24	18	
22	22	MG-H3	180M	MMG-H2	180M	39	0	61	-73	-3	0	0	0	0	0	45	38	
30	30	Siemens IE3	200L	MMG-H2	200LA	59	0	-23	-57	53	0	0	0	0	0	13	-17	
37	37	Siemens IE3	200L	MMG-H2	200LB	34	0	-23	-57	53	0	0	0	0	0	2	-23	
45	45	Siemens IE3	225M	MMG-H2	225MA	2	0	-23	-58	53	0	0	25	0	0	-18	-28	
55	55	Siemens IE3	250M	MMG-H2	250MA	28	0	-38	31	-23	0	0	0	0	0	-3	-23	
75	75	Siemens IE3	280S	MMG-H2	250SA	8	0	-32	31	-23	0	0	0	0	0	5	-15	
90	90	Siemens IE3	280M	MMG-H2	280MA	-50	0	-32	31	-23	0	0	51	0	0	-45	-65	
110	110	Siemens IE3	315S	MMG-H2	315SA	153	0	-15	46	-19	0	0	0	0	0	90	160	
132	132	Siemens IE3	315M	MMG-H2	315MA	98	0	-15	46	-19	0	0	0	0	0	80	80	
160	160	Siemens IE3	315L	MMG-H2	315LA	98	0	-15	46	-19	0	0	51	0	0	110	90	
200	200	Siemens IE3	315L	MMG-H2	315LB	-57	0	-15	46	-19	0	0	51	0	0	10	20	
250	250	Siemens IE3	315L	MMG-H2	355MA	138	40	142	194	-7	140	102	52	38	0	420	420	
315	315	Siemens IE3	315L	MMG-H2	355LB	138	40	142	194	-7	140	102	122	38	0	565	565	
355	355	Siemens IE3	355L	MMG-H2	355LC	-95	0	51	-	-30	-100	-20	-170	54	-5	20	20	

Note: The dimensions L and h4 refer to NK pumps, LB and AD to NB pumps.

IE2, MMG-H2, 4-pole

P2 [kW]		Motors on data pages		Other motors		L/LB	H	h4/AD	AG	LL	P	A	B	C	K	Weight [kg]		
50 Hz	60 Hz	Motor	Frame size	Motor	Frame size	[mm]											NK	NB
0.25	0.25	MG-C	71B	MMG-H2	71B	22	0	0	21	21	0	0	0	0	0	-0.1	-0.4	
0.37	0.37	MG-C	71B	MMG-H2	71B	22	0	0	21	21	0	0	0	0	0	0	-0.3	
0.55	0.55	MG-C	80A	MMG-H2	80B	29	0	21	28	28	0	0	0	0	0	3.7	2.9	
0.75	0.75	MG-H3	90S	MMG-H2	80B	-21	-10	20	-52	7	0	-15	0	-6	0	4.5	4	
1.1	1.1	MG-H3	90S	MMG-H2	90SA	-24	0	35	-47	7	0	0	0	0	0	-3	-4	
1.5	1.5	MG-H3	90L	MMG-H2	90LA	-39	0	35	-47	7	0	0	0	0	0	-1	-2	
2.2	2.2	MG-H3	100L	MMG-H2	100LA	-20	0	35	-47	12	0	0	0	0	0	3	-2	
3	3	MG-H3	100L	MMG-H2	100LB	-20	0	35	-47	12	0	0	0	0	0	2	0	
4	4	MG-H3	112M	MMG-H2	112MA	-47	0	34	-87	12	0	0	0	0	0	-10	-11	
5.5	5.5	MG-H3	132S	MMG-H2	132SA	-29	0	29	-65	3	0	0	0	0	0	-9	-9	
7.5	7.5	MG-H3	132M	MMG-H2	132MA	-41	0	29	-65	3	0	0	0	0	0	-8	-12	
11	11	MG-H3	160M	MMG-H2	160MA	-41	0	45	-73	-3	0	0	-44	0	0	20	13	
15	15	MG-H3	160L	MMG-H2	160LA	-27	0	45	-73	-3	0	0	0	0	0	18	12	
18.5	18.5	Siemens IE3	180M	MMG-H2	180MA	22	0	-21	-19	46	0	0	0	0	0	10	5	
22	22	Siemens IE3	180L	MMG-H2	180LA	30	0	-21	-19	46	0	0	38	0	0	14	4	
30	30	Siemens IE3	200L	MMG-H2	200LA	34	0	-23	-57	53	0	0	0	0	0	5	-5	
37	37	Siemens IE3	225S	MMG-H2	225SA	37	0	-23	-58	53	0	0	0	0	0	5	-10	
45	45	Siemens IE3	225M	MMG-H2	225MA	2	0	-23	-58	53	0	0	25	0	0	6	-9	
55	55	Siemens IE3	250M	MMG-H2	250MA	28	0	-38	31	-23	0	0	0	0	0	-35	-55	
75	75	Siemens IE3	280S	MMG-H2	280SA	8	0	-32	31	-23	0	0	0	0	0	-45	-75	
90	90	Siemens IE3	280M	MMG-H2	280MA	-50	0	-32	31	-23	0	0	51	0	0	-65	-85	
110	110	Siemens IE3	315S	MMG-H2	315SA	153	0	-15	46	-19	0	0	0	0	0	166	141	
132	132	Siemens IE3	315M	MMG-H2	315MA	98	0	-15	46	-19	0	0	0	0	0	67	27	
160	160	Siemens IE3	315L	MMG-H2	315LA	98	0	-15	46	-19	0	0	51	0	0	85	65	
200	200	Siemens IE3	315L	MMG-H2	315LB	-57	0	-15	46	-19	0	0	51	0	0	10	-20	
250	250	Siemens IE3	315L	MMG-H2	355MA	138	40	142	194	-7	0	102	52	38	-7	470	470	
315	315	Siemens IE3	315L	MMG-H2	355LB	-6	40	142	194	-7	0	102	122	38	-7	495	495	

Note: The dimensions L and h4 refer to NK pumps, LB and AD to NB pumps.

IE2, MMG-H2, 6-pole

P2 [kW]		Motors on data pages		Other motors		L/LB	H	h4/AD	AG	LL	P	A	B	C	K	Weight [kg]		
50 Hz	60 Hz	Motor	Frame size	Motor	Frame size	[mm]											NK	NB
0.37	0.37	Siemens	80A	MMG-H2	80	26	0	10	35	35	0	0	0	0	0.5	3	3	
0.55	0.55	Siemens	80B	MMG-H2	80	26	0	10	35	35	0	0	0	0	0.5	6	6	
0.75	0.75	Siemens IE3	90S	MMG-H2	90S	-40	0	19	22	31	0	0	0	0	0	-1	-1	
1.1	1.1	Siemens IE3	90L	MMG-H2	90L	-55	0	19	22	31	0	0	0	0	0	-2	-2	
1.5	1.5	Siemens IE3	100L	MMG-H2	100L	-21	0	-11	-20	3	0	0	0	0	0	-4	-4	
2.2	2.2	Siemens IE3	112M	MMG-H2	112M	-29	0	-9	-20	3	0	0	0	0	0	-10	-10	
3	3	Siemens IE3	132S	MMG-H2	132S	-35	0	-14	-17	8	0	0	0	0	0	-18	-23	
4	4	Siemens IE3	132M	MMG-H2	132M	3	0	-14	-17	8	0	0	0	0	0	-9	-14	
5.5	5.5	Siemens IE3	132M	MMG-H2	132M	-47	0	-14	-17	8	0	0	38	0	0	0	-17	
7.5	7.5	Siemens IE3	160M	MMG-H2	160M	10	0	12.5	-5	65	0	0	0	0	0	17	8	
11	11	Siemens IE3	160L	MMG-H2	160L	-6	0	12.5	-5	65	0	0	0	0	0	18	9	
15	15	Siemens IE3	180L	MMG-H2	180L	30	0	-21	-19	46	0	0	38	0	0	9	9	
18.5	18.5	Siemens IE3	200L	MMG-H2	200LA	59	0	-23	-57	53	0	0	0	0	0	9	1	
22	22	Siemens IE3	200L	MMG-H2	200LB	34	0	-23	-57	53	0	0	0	0	0	-7	-7	
30	30	Siemens IE3	225M	MMG-H2	225MA	2	0	-23	-58	53	0	0	25	0	0	-29	-44	
37	37	Siemens IE3	250M	MMG-H2	250MA	28	0	-38	31	-23	0	0	0	0	0	-25	-45	
45	45	Siemens IE3	280S	MMG-H2	280SA	8	0	-32	31	-23	0	0	0	0	0	-40	-60	
55	55	Siemens IE3	280M	MMG-H2	280MA	60	0	-32	31	-23	0	0	51	0	0	-15	-35	
75	75	Siemens IE3	315S	MMG-H2	315SA	153	0	-15	46	-19	0	0	0	0	0	86	86	
90	90	Siemens IE3	315M	MMG-H2	315MA	98	0	-15	46	-19	0	0	0	0	0	38	28	
110	110	Siemens IE3	315L	MMG-H2	315LA	98	0	-15	46	-19	0	0	51	0	0	120	100	
132	132	Siemens IE3	315L	MMG-H2	315LB	-57	0	-15	46	-19	0	0	51	0	0	65	45	
160	160	Siemens IE3	315L	MMG-H2	355MA	138	40	127	46	1	140	102	103	38	0	-	-	

Note: The dimensions L and h4 refer to NK pumps, LB and AD to NB pumps.

IE3

IE3, Siemens, 2-pole

P2 [kW]		Motors on data pages		Other motors		L/LB	H	h4/AD	AG	LL	P	A	B	C	K	Weight [kg]		
50 Hz	60 Hz	Motor	Frame size	Motor	Frame size	[mm]											NK	NB
0.75	0.75	MG-H3	80A	Siemens IE3	80M	21	0	12	11	-3	0	0	0	0	-0.5	3		
1.1	1.1	MG-H3	80C	Siemens IE3	80M	1	0	12	11	-3	0	0	0	0	-0.5	3		
1.5	1.5	MG-H3	90S	Siemens IE3	90S	16	0	16	-69	-24	0	0	0	0	0	-1		
2.2	2.2	MG-H3	90L	Siemens IE3	90L	-24	0	16	-69	-24	0	0	25	0	0	0		
3	3	MG-H3	100L	Siemens IE3	100L	35.5	0	46	-27	9	0	0	0	0	0	3	2	
4	4	MG-H3	112M	Siemens IE3	112M	-18	0	43	-67	9	0	0	0	0	0	-8	-8	
5.5	5.5	MG-H3	132S	Siemens IE3	132S	-6	0	68	-47	27	0	0	0	0	0	3	6	
7.5	7.5	MG-H3	132S	Siemens IE3	132S	56	0	43	-48	-5	0	0	0	0	0	6	8	
11	11	MG-H3	160M	Siemens IE3	160M	23	0	32.5	-68	-68	0	0	0	0	0	-11	-8	
15	15	MG-H3	160M	Siemens IE3	160M	23	0	32.5	-68	-68	0	0	0	0	0	-14	-12	
18.5	18.5	MG-H3	160L	Siemens IE3	160L	39	0	32.5	-68	-68	0	0	0	0	0	-18	-15	
22	22	MG-H3	180M	Siemens IE3	180M	17	0	82	-54	-49	0	0	0	0	0	43	35	

Note: The dimensions L and h4 refer to NK pumps, LB and AD to NB pumps.

IE3, Siemens, 4-pole

P2 [kW]		Motors on data pages		Other motors		L/LB	H	h4/AD	AG	LL	P	A	B	C	K	Weight [kg]		
50 Hz	60 Hz	Motor	Frame size	Motor	Frame size	[mm]											NK	NB
0.75	0.75	MG-H3	90S	Siemens IE3	80	-29	-10	11	-69	-24	0	-15	0	-6	-0.5	-4		
1.1	1.1	MG-H3	90S	Siemens IE3	90S	16	0	16	-69	-24	0	0	0	0	0	-4.3		
1.5	1.5	MG-H3	90L	Siemens IE3	90L	-24	0	16	-69	-24	0	0	0	0	0	-3.7		
2.2	2.2	MG-H3	100L	Siemens IE3	100L	35.5	0	46	-27	9	0	0	0	0	0	8	4	
3	3	MG-H3	100L	Siemens IE3	100L	35.5	0	46	-27	9	0	0	0	0	0	3	2	
4	4	MG-H3	112M	Siemens IE3	112M	-18	0	43	-67	9	0	0	0	0	0	-9	-9	
5.5	5.5	MG-H3	132S	Siemens IE3	132S	56	0	43	-48	-5	0	0	0	0	0	8	-2	
7.5	7.5	MG-H3	132M	Siemens IE3	132M	6	0	43	-48	-5	0	0	-38	0	0	-4	-3	
11	11	MG-H3	160M	Siemens IE3	160M	-51	0	32.5	-68	-68	0	0	-44	0	0	-12	-10	
15	15	MG-H3	160L	Siemens IE3	160L	-21	0	32.5	-68	-68	0	0	0	0	0	-17	-14	

Note: The dimensions L and h4 refer to NK pumps, LB and AD to NB pumps.

IE3, MMG-E, 2-pole

P2 [kW]		Motors on data pages		Other motors		L/LB	H	h4/AD	AG	LL	P	A	B	C	K	Weight [kg]		
50 Hz	60 Hz	Motor	Frame size	Motor	Frame size	[mm]											NK	NB
0.75		MG-H3	80A	MMG-E	80A	24	0	27.5	12	12	77	0	0	0	0	10	7	
1.1		MG-H3	80C	MMG-E	80B	4	0	27.5	12	12	-3	0	0	0	0	8	5	
1.5		MG-H3	90S	MMG-E	90S	-16	0	43.5	-54	-1	0	0	0	0	0	3	6	
2.2		MG-H3	90L	MMG-E	90L	9	0	43.5	-54	-1	0	0	25	0	0	6	7	
3		MG-H3	100L	MMG-E	100L	-20	0	53	-51	-1	-1	0	0	0	0	13	13	
4		MG-H3	112M	MMG-E	112M	38	0	56	-84	7	0	0	0	0	0	14	14	
5.5		MG-H3	132S	MMG-E	132SA	-1	0	76	-84	7	0	0	0	-39	-12	24	27	
7.5		MG-H3	132S	MMG-E	132SB	20	0	51	-85	-25	6	0	0	0	0	21	23	
11		MG-H3	160M	MMG-E	160MA	27	0	48	-82	-62	0	0	0	0	0	31	37	
15		MG-H3	160M	MMG-E	160MB	27	0	48	-82	-62	0	0	0	0	0	29	34	
18.5		MG-H3	160L	MMG-E	160L	27	0	48	-82	-62	0	0	0	0	0	32	38	
22		MG-H3	180M	MMG-E	180M	67	0	71	-82	-62	0	0	0	0	0	69	68	
30		Siemens IE3	200L	MMG-E	200LA	56	0	-5	-36	-8	0	0	0	0	0	15	30	
37		Siemens IE3	200L	MMG-E	200LB	31	0	-5	-36	-8	0	0	0	0	0	5	20	
45		Siemens IE3	225M	MMG-E	225M	2	0	-3	-37	-8	-1	0	0	0	0	23	29	
55		Siemens IE3	250M	MMG-E	250M	28	0	-45	-73	-17	0	0	0	0	0	42	65	
75		Siemens IE3	280S	MMG-E	280S	10	0	-33	-73	-17	0	0	0	0	0	59	83	
90		Siemens IE3	280M	MMG-E	280M	-50	0	-33	-73	-17	0	0	0	0	0	28	50	
110		Siemens IE3	315S	MMG-E	315S	146	0	-32	-54	-19	0	0	0	0	0	205	87	
132		Siemens IE3	315M	MMG-E	315M	91	0	-32	-54	-19	0	0	0	0	0	196	150	
160		Siemens IE3	315L	MMG-E	315LA	91	0	-32	-54	-19	0	0	0	0	0	176	120	
200		Siemens IE3	315L	MMG-E	315LB	-64	0	-32	-54	-19	0	0	0	0	0	546	-20	
250		Siemens IE3	315L	MMG-E	355M	128	40	155	154	23	-	102	52	38	0	380	-	
315		Siemens IE3	315L	MMG-E	355L	128	40	155	154	23	-	102	52	38	0	520	-	
355		Siemens IE3	355L	MMG-E	355L	45	0	-35	-217	0	-	-20	-240	54	-5	180	-	

IE3, MMG-E, 4-pole

P2 [kW]		Motors on data pages		Other motors		L/LB	H	h4/AD	AG	LL	P	A	B	C	K	Weight [kg]		
50 Hz	60 Hz	Motor	Frame size	Motor	Frame size	[mm]											NK	NB
0.75		MG-H3	90S	MMG-E	80B	-26	-10	26.5	-68	-9	-3	-15	0	-6	0	0	5	
1.1		MG-H3	90S	MMG-E	90S	4	0	43.5	-54	-1	0	0	0	0	0	4.7	10	
1.5		MG-H3	90L	MMG-E	90L	14	0	43.5	-54	-1	0	0	25	0	0	5.3	10	
2.2		MG-H3	100L	MMG-E	100LA	-10	0	49.5	-54	-1	0	0	0	0	0	14	9	
3		MG-H3	100L	MMG-E	100LB	10	0	49.5	-54	-1	0	0	0	0	0	9	7	
4		MG-H3	112M	MMG-E	112M	38	0	53.5	-84	7	0	0	0	0	0	13	12	
5.5		MG-H3	132S	MMG-E	132S	11	0	48.5	-85	-25	0	0	0	0	0	13	13	
7.5		MG-H3	132M	MMG-E	132M	1	0	48.5	-85	-25	0	0	0	0	0	11	7	
11		MG-H3	160M	MMG-E	160M	-40	0	47.5	-82	-62	0	0	-44	0	0	43	33	
15		MG-H3	160L	MMG-E	160L	-15	0	47.5	-82	-62	0	0	0	0	0	42	33	
18.5		Siemens IE3	180M	MMG-E	180M	12	0	-20	-28	-14	0	0	0	0	0	25	43	
22		Siemens IE3	180L	MMG-E	180L	20	0	-20	-28	-13	0	0	0	0	4	32	33	
30		Siemens IE3	200L	MMG-E	200L	31	0	-13	-36	-8	-1	0	0	0	0	19	24	
37		Siemens IE3	225S	MMG-E	225S	32	0	-13	-37	-8	-1	0	0	0	0	9	12	
45		Siemens IE3	225M	MMG-E	225M	-3	0	-13	-37	-8	-1	0	0	0	0	10	13	
55		Siemens IE3	250M	MMG-E	250M	28	0	-46	-73	-17	0	0	0	0	0	18	-115	
75		Siemens IE3	280S	MMG-E	280S	10	0	-40	-73	-17	0	0	0	0	0	-7	-37	
90		Siemens IE3	280M	MMG-E	280M	-50	0	-40	-73	-17	0	0	0	0	0	-21	-30	
110		Siemens IE3	315S	MMG-E	315S	96	0	-32	-54	-19	0	0	0	0	0	151	130	
132		Siemens IE3	315M	MMG-E	315M	41	0	-32	-54	-19	0	0	0	0	0	121	85	
160		Siemens IE3	315L	MMG-E	315LA	41	0	-32	-54	-19	0	0	0	0	0	137	121	
200		Siemens IE3	315L	MMG-E	315LB	-114	0	-32	-54	-19	0	0	0	0	0	36	20	
250		Siemens IE3	315L	MMG-E	355M	134	40	155	154	23	-	102	52	38	-7	465	-	
315		Siemens IE3	315L	MMG-E	355L	-10	40	155	154	23	-	102	52	38	-7	340	-	

IE3, MMG-E, 6-pole

P2 [kW]		Motors on data pages		Other motors		L/LB	H	h4/AD	AG	LL	P	A	B	C	K	Weight [kg]		
50 Hz	60 Hz	Motor	Frame size	Motor	Frame size	[mm]											NK	NB
0.75		Siemens IE3	90S	MMG-E	90S	-12	0	27.5	15	23	0	0	0	0	0	7	8	
1.1		Siemens IE3	90L	MMG-E	90L	-2	0	27.5	15	23	0	0	25	0	0	6	7	
1.5		Siemens IE3	100L	MMG-E	100L	-21	0	7	-27	-10	-1	0	0	0	0	6	7	
2.2		Siemens IE3	112M	MMG-E	112M	56	0	13	-17	-2	0	0	0	0	0	23	23	
3		Siemens IE3	132S	MMG-E	132S	14	0	8	-37	-20	6	0	0	0	0	20	15	
4		Siemens IE3	132M	MMG-E	132MA	45	0	5.5	-37	-20	0	0	0	0	0	32	27	
5.5		Siemens IE3	132M	MMG-E	132MB	35	0	5.5	-37	-20	0	0	0	0	0	44	27	
7.5		Siemens IE3	160M	MMG-E	160M	11	0	15	-14	6	0	0	0	0	0	30	28	
11		Siemens IE3	160L	MMG-E	160L	6	0	15	-14	6	0	0	0	0	0	37	35	
15		Siemens IE3	180L	MMG-E	180L	20	0	-20	-28	-13	0	0	38	0	4	28	40	
18.5		Siemens IE3	200L	MMG-E	200LA	56	0	-13	-36	-8	-1	0	0	0	0	24	31	
22		Siemens IE3	200L	MMG-E	200LB	31	0	-13	-36	-8	-1	0	0	0	0	45	35	
30		Siemens IE3	225M	MMG-E	225M	-3	0	-13	-37	-8	-1	0	25	0	0	112	25	
37		Siemens IE3	250M	MMG-E	250M	28	0	-46	-73	-17	0	0	0	0	0	125	43	
45		Siemens IE3	280S	MMG-E	280S	10	0	-40	-73	-17	0	0	0	0	0	130	13	
55		Siemens IE3	280M	MMG-E	280M	60	0	-40	-73	-17	0	0	51	0	0	118	59	
75		Siemens IE3	315S	MMG-E	315S	96	0	-32	-54	-19	0	0	0	0	0	385	169	
90		Siemens IE3	315M	MMG-E	315M	41	0	-32	-54	-19	0	0	0	0	0	231	95	

IE3, MMG-H3, 2-pole

P2 [kW]		Motors on data pages		Other motors		L/LB	H	h4/AD	AG	LL	P	A	B	C	K	Weight [kg]	
50 Hz	60 Hz	Motor	Frame size	Motor	Frame size	[mm]										NK	NB
0.75	0.75	MG-H3	80A	MMG-H3	80B	29	0	21	28	28	0	0	0	0	0	2.6	1.7
1.1	1.1	MG-H3	80C	MMG-H3	80B	9	0	21	28	28	0	0	0	0	0	3.5	2.4
1.5	1.5	MG-H3	90S	MMG-H3	90SA	-24	0	35	-47	7	0	0	0	0	0	0	-1
2.2	2.2	MG-H3	90L	MMG-H3	90LA	-39	0	35	-47	7	0	0	0	0	0	-1	-2
3	3	MG-H3	100L	MMG-H3	100LA	-20	0	35	-47	12	0	0	0	0	0	1	-1
4	4	MG-H3	112M	MMG-H3	112MA	-47	0	34	-87	12	0	0	0	0	0	-14	-15
5.5	5.5	MG-H3	132S	MMG-H3	132SA	-41	0	54	-64	35	0	0	0	0	0	0	-2
7.5	7.5	MG-H3	132S	MMG-H3	132SB	9	0	29	-65	3	0	0	38	0	0	-8	-11
11	11	MG-H3	160M	MMG-H3	160MA	33	0	45	-73	-3	0	0	0	0	0	23	17
15	15	MG-H3	160M	MMG-H3	160MB	33	0	45	-73	-3	0	0	0	0	0	21	14
18.5	18.5	MG-H3	160L	MMG-H3	160L	33	0	45	-73	-3	0	0	0	0	0	24	18
22	22	MG-H3	180M	MMG-H3	180M	39	0	61	-73	-3	0	0	0	0	0	45	38
30	30	Siemens IE3	200L	MMG-H3	200LA	59	0	-23	-57	53	0	0	0	0	0	13	-17
37	37	Siemens IE3	200L	MMG-H3	200LB	34	0	-23	-57	53	0	0	0	0	0	2	-23
45	45	Siemens IE3	225M	MMG-H3	225MA	2	0	-23	-58	53	0	0	25	0	0	-18	-28
55	55	Siemens IE3	250M	MMG-H3	250MA	28	0	-38	31	-23	0	0	0	0	0	-3	-23
75	75	Siemens IE3	280S	MMG-H3	280SA	8	0	-32	31	-23	0	0	0	0	0	5	-15
90	90	Siemens IE3	280M	MMG-H3	280MA	-50	0	-32	31	-23	0	0	51	0	0	-45	-65
110	110	Siemens IE3	315S	MMG-H3	315SA	153	0	-15	46	-19	0	0	0	0	0	90	160
132	132	Siemens IE3	315M	MMG-H3	315MA	98	0	-15	46	-19	0	0	0	0	0	80	80
160	160	Siemens IE3	315L	MMG-H3	315LA	98	0	-15	46	-19	0	0	51	0	0	110	90
200	200	Siemens IE3	315L	MMG-H3	315LB	-57	0	-15	46	-19	0	0	51	0	0	10	20

Note: The dimensions L and h4 refer to NK pumps, LB and AD to NB pumps.

IE3, MMG-H3, 4-pole

P2 [kW]		Motors on data pages		Other motors		L/LB	H	h4/AD	AG	LL	P	A	B	C	K	Weight [kg]	
50 Hz	60 Hz	Motor	Frame size	Motor	Frame size	[mm]										NK	NB
0.75	0.75	MG-H3	90S	MMG-H3	80B	-21	-10	20	-52	7	0	-15	0	-6	0	4.5	4
1.1	1.1	MG-H3	90S	MMG-H3	90SA	-24	0	35	-47	7	0	0	0	0	0	-3	-4
1.5	1.5	MG-H3	90L	MMG-H3	90LA	-39	0	35	-47	7	0	0	0	0	0	-1	-2
2.2	2.2	MG-H3	100L	MMG-H3	100LA	-20	0	35	-47	12	0	0	0	0	0	3	-2
3	3	MG-H3	100L	MMG-H3	100LB	-20	0	35	-47	12	0	0	0	0	0	2	0
4	4	MG-H3	112M	MMG-H3	112MA	-47	0	34	-87	12	0	0	0	0	0	-10	-11
5.5	5.5	MG-H3	132S	MMG-H3	132SA	-29	0	29	-65	3	0	0	0	0	0	-9	-9
7.5	7.5	MG-H3	132M	MMG-H3	132MA	-41	0	29	-65	3	0	0	0	0	0	-8	-12
11	11	MG-H3	160M	MMG-H3	160MA	-41	0	45	-73	-3	0	0	-44	0	0	20	13
15	15	MG-H3	160L	MMG-H3	160LA	-27	0	45	-73	-3	0	0	0	0	0	18	12
18.5	18.5	Siemens IE3	180M	MMG-H3	180MA	22	0	-21	-19	46	0	0	0	0	0	10	5
22	22	Siemens IE3	180L	MMG-H3	180LA	30	0	-21	-19	46	0	0	38	0	0	14	4
30	30	Siemens IE3	200L	MMG-H3	200LA	34	0	-23	-57	53	0	0	0	0	0	5	-5
37	37	Siemens IE3	225S	MMG-H3	225SA	37	0	-23	-58	53	0	0	0	0	0	5	-10
45	45	Siemens IE3	225M	MMG-H3	225MA	2	0	-23	-58	53	0	0	25	0	0	6	-9
55	55	Siemens IE3	250M	MMG-H3	250MA	28	0	-38	31	-23	0	0	0	0	0	-35	-55
75	75	Siemens IE3	280S	MMG-H3	280SA	8	0	-32	31	-23	0	0	0	0	0	-45	-75
90	90	Siemens IE3	280M	MMG-H3	280MA	-50	0	-32	31	-23	0	0	51	0	0	-65	-85
110	110	Siemens IE3	315S	MMG-H3	315SA	153	0	-15	46	-19	0	0	0	0	0	166	141
132	132	Siemens IE3	315M	MMG-H3	315MA	98	0	-15	46	-19	0	0	0	0	0	67	27
160	160	Siemens IE3	315L	MMG-H3	315LA	98	0	-15	46	-19	0	0	51	0	0	85	65
200	200	Siemens IE3	315L	MMG-H3	315LB	-57	0	-15	46	-19	0	0	51	0	0	10	-20

Note: The dimensions L and h4 refer to NK pumps, LB and AD to NB pumps.

21. Accessories

Counter-flanges

Cast iron pumps

Counter-flanges for cast iron NB, NBE and NK, NKE pumps are made of steel.

A set consists of one counter-flange, one gasket of asbestos-free material and the requisite number of bolts and nuts.

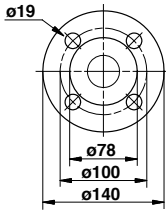
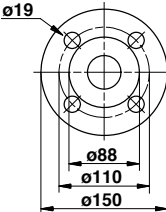
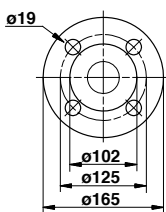
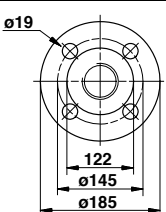
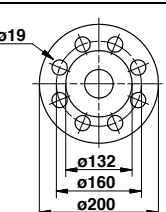
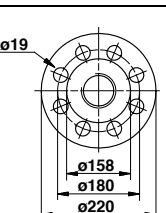
Counter-flange	Flange size	Description	Rated pressure [bar] EN 1092-2	Pipe connection	Product number
	TM03 0400 5004 DN 32	Threaded	10/16	Rp 1 1/4	419901
		For welding	10/16	32 mm	419902
	TM03 0401 5004 DN 40	Threaded	10/16	Rp 1 1/2	429902
		For welding	10/16	40 mm	429901
	TM03 0402 5004 DN 50	Threaded	10/16	Rp 2	339903
		For welding	10/16	50 mm	339901
	TM03 0403 5004 DN 65	Threaded	10/16	Rp 2 1/2	349902
		For welding	10/16	65 mm	349904
	TM03 2117 3705 DN 80	Threaded	10/16	Rp 3	350540
		For welding	10/16	80 mm	350541
	TM03 0405 5004 DN 100	Threaded	10/16	Rp 4	369901
		For welding	10/16	100 mm	369902

Counter-flange	Flange size	Description	Rated pressure [bar] EN 1092-2	Pipe connection	Product number
	TM03 0406 5004 DN 125	For welding	10/16	125 mm	96414677
	TM03 0407 5004 DN 150	For welding	10/16	150 mm	96414676
	TM04 4364 5109 DN 200	For welding	16	200 mm	96691093
	TM03 0270 0807 DN 250	For welding	10	250 mm	99457575
	TM07 1603 1818 DN 250	For welding	16	250 mm	96890361
	TM03 0271 0807 DN 300	For welding	10	300 mm	99457580
	TM07 1588 1818 DN 300	For welding	16	300 mm	96890401

Stainless steel pumps

Counter-flanges for stainless steel NB, NBE and NK, NKE pumps are made of stainless steel according to EN 1.4401 (AISI 316).

A set consists of one counter-flange, one gasket of asbestos-free material and the requisite number of bolts and nuts.

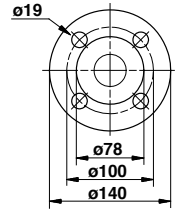
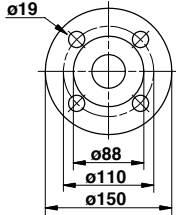
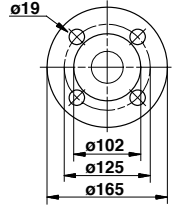
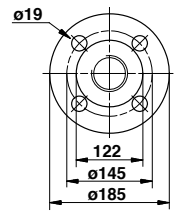
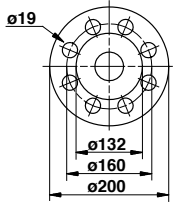
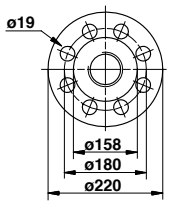
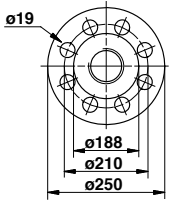
Counter-flange	Flange size	Description	Rated pressure [bar] EN 1092-2	Pipe connection	Product number
	TM03 0400 5004 DN 32	Threaded	10/16	Rp 1 1/4	415304
		For welding	10/16	32 mm	415305
	TM03 0401 5004 DN 40	Threaded	10/16	Rp 1 1/2	425245
		For welding	10/16	40 mm	425246
	TM03 0402 5004 DN 50	Threaded	10/16	Rp 2	335254
		For welding	10/16	50 mm	335255
	TM03 0403 5004 DN 65	Threaded	10/16	Rp 2 1/2	349910
		For welding	10/16	65 mm	349906
	TM03 2117 3705 DN 80	Threaded	10/16	Rp 3	350543
		For welding	10/16	80 mm	350544
	TM03 0405 5004 DN 100	Threaded	10/16	Rp 4	369904
		For welding	10/16	100 mm	369903
	TM03 0406 5004 DN 125	For welding	16 bar, EN 1092-2	125 mm	96694017

Counter-flange	Flange size	Description	Rated pressure [bar] EN 1092-2	Pipe connection	Product number
	<p>TM03 0407 5004</p> <p>DN 150</p>	For welding	10/16	150 mm	98052936
	<p>TM04 4364 5109</p> <p>DN 200</p>	For welding	10	200 mm	98052931

Sensors

Grundfos vortex flow sensor, VFI ¹	Type	Flow range [m ³ /h]	Pipe connection	O-ring		Connection type		Product number
				EPDM	FKM	Cast iron flange	Stainless steel flange	
	VFI 1.3-25 DN32 020 E	1.3 - 25	DN 32	•		•		97686141
	VFI 1.3-25 DN32 020 F				•	•		97686142
	VFI 1.3-25 DN32 020 E				•		•	97688297
	VFI 1.3-25 DN32 020 F				•	•	•	97688298
	VFI 2-40 DN40 020 E	2-40	DN 40	•		•		97686143
	VFI 2-40 DN40 020 F				•	•		97686144
	VFI 2-40 DN40 020 E				•		•	97688299
	VFI 2-40 DN40 020 F				•	•	•	97688300
	VFI 3.2-64 DN50 020 E	2-64	DN 50	•		•		97686145
	VFI 3.2-64 DN50 020 F				•	•		97686146
	VFI 3.2-64 DN50 020 E				•		•	97688301
	VFI 3.2-64 DN50 020 F				•	•	•	97688302
	VFI 5.2-104 DN65 020 E	5.2 - 104	DN 65	•		•		97686147
	VFI 5.2-104 DN65 020 F				•	•		97686148
	VFI 5.2-104 DN65 020 E				•		•	97688303
	VFI 5.2-104 DN65 020 F				•	•	•	97688304
	VFI 8-160 DN80 020 E	8-160	DN 80	•		•		97686149
	VFI 8-160 DN80 020 F				•	•		97686150
	VFI 8-160 DN80 020 E				•		•	97688305
	VFI 8-160 DN80 020 F				•	•	•	97688306
VFI 12-240 DN100 020 E	12-240	DN 100	•		•		97686151	
VFI 12-240 DN100 020 F				•	•		97686152	
VFI 12-240 DN100 020 E				•		•	97688308	
VFI 12-240 DN100 020 F				•	•	•	97688309	

- Sensor tube with sensor
- Sensor tube of 1.4408 and sensor of 1.4404
- 2 flanges
- 5 m cable with M12 connection in one end
- Quick guide

¹ For more information about the VFI sensor, see the "Grundfos direct sensors" data booklet, publication number 97790189.

Grundfos differential pressure sensor, DPI	Content of sensor kit	Data sheet product number ²	Pressure range [bar]	Product number
	• 1 sensor (7/16" connections), including 0.9 m screened cable	96985439	0 - 0.6	96611522
	• 1 original DPI bracket, for wall mounting	96985440	0 - 1.0	96611523
	• 1 Grundfos bracket, for mounting on motor	96985441	0 - 1.6	96611524
	• screws for mounting of sensor on bracket and motor	96985463	0 - 2.5	96611525
	• 3 capillary tubes, short or long	96985464	0 - 4.0	96611526
	• 2 fittings, 1/4" - 7/16"	96985465	0 - 6.0	96611527
	• 5 cable clips, black	96985466	0-10	96611550
	• installation and operating instructions			
	• service kit instruction			

² Enter the product number of the data sheet into Grundfos Product Center to view data for the sensor.

Note: Select the differential pressure sensor so that the maximum pressure of the sensor is higher than the maximum differential pressure of the pump.

External Grundfos sensors

Sensor	Type	Supplier	Measuring range [bar]	Transmitter output [mA]	Power supply [VDC]	Process connection	Product number
Pressure transmitter	RPI	Grundfos	0 - 0.6	4-20	12-30	G 1/2	97748907
			0 - 1.0				97748908
			0 - 1.6				97748909
			0 - 2.5				97748910
			0 - 4.0				97748921
			0 - 6.0				97748922
			0-12				97748923
			0-16				97748924

Sensor interface, SI 001 PSU ³	Description	Product number
---	-------------	----------------



Grundfos Direct Sensors™, type SI 001 PSU, is an external power supply for the VFI, DPI and other transmitters with 24 VDC supply voltage. It is used when the cable between transmitter and controller is more than 30 metres long.

96915820

³ For more information about the PSU sensor interface, see the Installation and operating instructions "SI 001 PSU - sensor interface", publication number 96944355, or Quick guide, publication number 96944356.

Danfoss pressure sensor kit	Pressure range [bar]	Product number
<ul style="list-style-type: none"> • Connection: G 1/2 A (DIN 16288 - B6kt) • Electrical connection: Plug (DIN 43650) 	0 - 2.5	96478188
	0-4	91072075
	0-6	91072076
	0-10	91072077
	0-16	91072078
<ul style="list-style-type: none"> • Pressure sensor, type MBS 3000, with 2 m screened cable • Connection: G 1/4 A (DIN 16288 - B6kt) • 5 cable clips, black • Fitting instructions PT (00400212) 	0 - 2.5	405159
	0-4	405160
	0-6	405161
	0-10	405162
	0-16	405163

	Type	Supplier	Measuring range	Product number
Flowmeter	SITRANS F M MAGFLO MAG 5100 W	Siemens	1-5 m ³ /h (DN 25)	ID8285
Flowmeter	SITRANS F M MAGFLO MAG 5100 W	Siemens	3-10 m ³ /h (DN 40)	ID8286
Flowmeter	SITRANS F M MAGFLO MAG 5100 W	Siemens	6-30 m ³ /h (DN 65)	ID8287
Flowmeter	SITRANS F M MAGFLO MAG 5100 W	Siemens	20-75 m ³ /h (DN 100)	ID8288
Temperature sensor	TTA (0) 25	Carlo Gavazzi	0-25 °C	96432591
Temperature sensor	TTA (-25) 25	Carlo Gavazzi	-25 to +25 °C	96430194
Temperature sensor	TTA (50) 100	Carlo Gavazzi	50-100 °C	96432592
Temperature sensor	TTA (0) 150	Carlo Gavazzi	0-150 °C	96430195
Accessory for temperature sensor. All with 1/2 RG connection.	Protecting tube Ø9 x 50 mm	Carlo Gavazzi		96430201
	Protecting tube Ø9 x 100 mm	Carlo Gavazzi		96430202
	Cutting ring bush	Carlo Gavazzi		96430203
Temperature sensor, ambient temperature	WR 52	tmg (DK: Plesner)	-50 to +50 °C	ID8295
Differential temperature sensor	ETSD	Honsberg	0-20 °C	96409362
Differential temperature sensor	ETSD	Honsberg	0-50 °C	96409363

Note: All sensors have 4-20 mA output signal.

Potentiometer

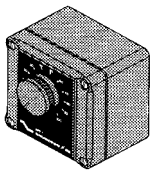

Potentiometer for setpoint setting and start/stop of the pump.

Product	Product number
External potentiometer with cabinet for wall mounting	625468

Grundfos GO

Grundfos GO is used for wireless infrared or radio communication with the pumps.

A number of Grundfos GO variants are available. The variants are described in the following.

MI 204

MI 204 is an add-on module with built-in infrared and radio communication.

You can use MI 204 in conjunction with Apple iPod Touch 5G, iPhone 5 or later.

MI 204



TM05 7704 1513

Fig. 89 MI 204

Supplied with the product:

- Grundfos MI 204
- sleeve
- quick guide
- charger cable.

MI 204 with iPod touch kit

Supplied with the product:

- Apple iPod touch 5G
- Grundfos MI 204
- protective cover for the iPod touch
- charger
- MI 204 sleeve
- printed quick guide.

MI 301

MI 301 is a module with built-in infrared and radio communication. Use MI 301 in conjunction with an Android or iOS-based smart devices with a Bluetooth connection. MI 301 has a rechargeable Li-ion battery and you must charge it separately.



TM05 3890 1712

Fig. 90 MI 301

Supplied with the product:

- Grundfos MI 301
- sleeve
- battery charger
- quick guide.

Product numbers

Grundfos GO variant	Product number
Grundfos MI 204	98424092
Grundfos MI 204 with iPod touch kit	98612711
Grundfos MI 301	98046408

Supported units

Make	Model	Operating system	MI 204	MI 301
Apple	iPod touch 4G	iOS 5.0 or later		•
	iPhone 4, 4S			•
	iPod touch 5G	iOS 6.0 or later	•	•
	iPhone 5		•	•
HTC	Desire S	Android 2.3.3 or later		•
	Sensation			•
Samsung	Galaxy S II	Android 4.0 or later		•
	Galaxy Nexus			•
LG	Google Nexus 4	Android 4.2 or later		•

Note: Similar Android and iOS-based devices may work as well, but are not supported by Grundfos.

CIU communication interface units



GFA 6118

Fig. 91 Grundfos CIU communication interface unit

The CIU units enable communication of operating data, such as measured values and setpoints, between E-pumps and a building management system. The CIU unit incorporates a 24-240 VAC/VDC power supply module and a CIM module. It can either be mounted on a DIN rail or on a wall.

We offer the following CIU units:

Description	Fieldbus protocol	Product number
CIU 100	LONWorks for pumps	96753735
CIU 150	PROFIBUS DP	96753081
CIU 200	Modbus RTU	96753082
CIU 250*	GSM	96787106
CIU 270*	GRM	96898819
CIU 300	BACnet MS/TP	96893769
CIU 500	Ethernet, BACnet IP	96753894
CIU 500	Ethernet, Modbus TCP	
CIU 500	Ethernet, PROFINET IO	
CIU 500	Ethernet, GRM IP	
CIU 500	Ethernet, EtherNet/IP	
CIU 900	CIU box without CIM	99448387
CIU 901	CIU box with IO 270 only	99448389

* Antenna not included. See [Antennas and battery](#).

For further information about data communication via CIU units and fieldbus protocols, see the CIU documentation available in Grundfos Product Center.

CIM communication interface modules



GRA6121

Fig. 92 Grundfos CIM communication interface module

The CIM modules enable communication of operating data, such as measured values and setpoints, between E-pumps of 11-22 kW and a building management system. The CIM modules are add-on communication modules which are installed in the terminal box.

Note: CIM modules must be installed by authorised personnel.

We offer the following CIM modules:

Product	Description	Product number
CIM 100	LONWorks for pumps	96824797
CIM 110	LONWorks for multipump	96824798
CIM 150	PROFIBUS DP	96824793
CIM 200	Modbus RTU	96824796
CIM 250*	GSM	96824795
CIM 260-EU*	3G/4G cellular	99439302
CIM 260-US*	3G/4G cellular	99439306
CIM 270*	GRM	96898815
CIM 280-EU*	GiC/GRM 3G/4G	99439724
CIM 280-US*	GiC/GRM 3G/4G	99439725
CIM 300	BACnet MS/TP	96893770
CIM 500	Ethernet, BACnet IP	98301408
CIM 500	Ethernet, Modbus TCP	
CIM 500	Ethernet, PROFINET IO	
CIM 500	Ethernet, GRM IP	
CIM 500	Ethernet, EtherNet/IP	

* Antenna not included. See [Antennas and battery](#).

For further information about data communication via CIM modules and fieldbus protocols, see the CIM documentation available in Grundfos Product Center.

Antennas and battery

Description	Product number
Antenna for roof for CIM/CIU 250/270	97631956
Antenna for desk for CIM/CIU 250/270	97631957
Antenna (rod) 3G/4G for CIM 260/280	99043061
Antenna (puc) 3G/4G for CIM 260/280	99518079
CIM 250 battery	99499908

EMC filter

EMC (electromagnetic compatibility to EN 61800-3)

Motor [kW]		Emission/immunity
2-pole	4-pole	
0.37	0.37	
0.55	0.55	
0.75	0.75	Emission Motors may be installed in residential areas (first environment), unrestricted distribution, corresponding to CISPR11, group 1, class B.
1.1	1.1	
1.5	1.5	
2.2	2.2	
3.0	3.0	Immunity Motors fulfil the requirements for both the first and second environment.
4.0	4.0	
5.5	-	
7.5	-	
-	5.5	Emission The motors are category C3, corresponding to CISPR11, group 2, class A, and may be installed in industrial areas (second environment).
-	7.5	
11	11	If equipped with an external Grundfos EMC filter, the motors are category C2, corresponding to CISPR11, group 1, class A, and may be installed in residential areas (first environment).
15	15	
18.5	18.5	
22	-	



TM02 9198 1203

Fig. 93 EMC filter

The EMC filter for residential areas is available as a complete kit ready for installation.

Product	Product number
EMC filter (5.5 kW and 7.5 kW, 4-pole)	96041047
EMC filter (11-22 kW)	96478309

Shims

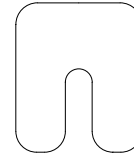

TM04 3264 0908

Fig. 94 Shim

Shims to adjust motor height when aligning pump and motor.

Product	Product number
Small case (180 pcs)	96659156
Large case (360 pcs)	96659157

Each case contains three types of shims:

Type 1: 55 x 50 mm, 15 mm slot.

Type 2: 75 x 70 mm, 23 mm slot.

Type 3: 90 x 80 mm, 32 mm slot.

Each type has ten of each of three sizes: 0.05; 0.1; 0.2; 0.5; 0.7; 1 mm.

A large case contains 20 of each of the above-mentioned shims. Refills can be found via service.

Support blocks, NB

Steel support blocks are used to compensate for dimensional differences between pump housing and motor frame sizes. The support blocks can be fitted under the motor or pump housing feet during installation thus enabling horizontal alignment of the pump.

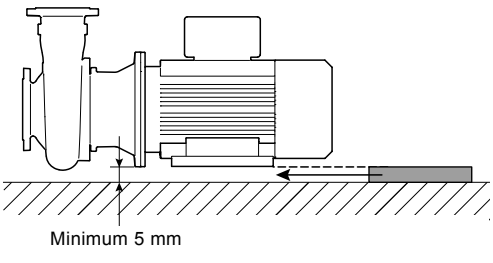
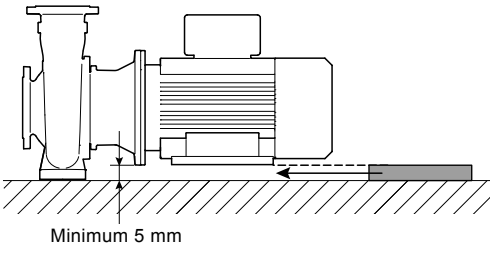
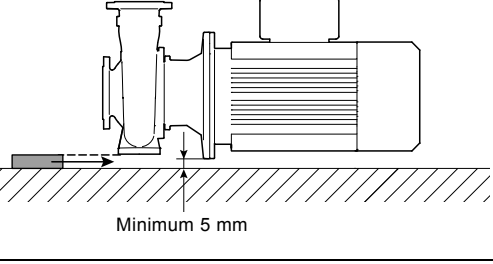
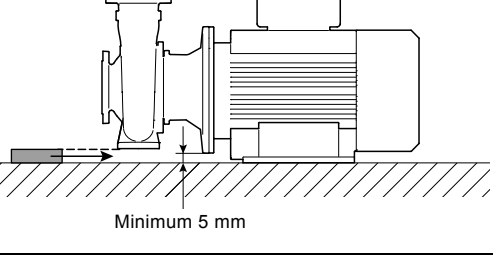
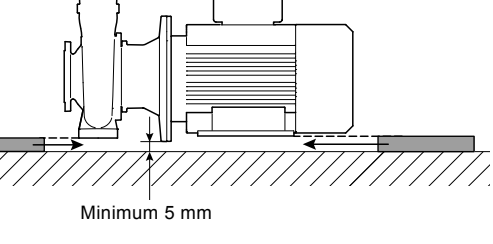
Support blocks	
No	Position
1a	 <p>Minimum 5 mm</p> <p style="text-align: right;">TM05 1458 2711</p>
1b	 <p>Minimum 5 mm</p> <p style="text-align: right;">TM05 1459 2711</p>
2a	 <p>Minimum 5 mm</p> <p style="text-align: right;">TM05 1462 2711</p>
2b	 <p>Minimum 5 mm</p> <p style="text-align: right;">TM05 1460 2711</p>
3	 <p>Minimum 5 mm</p> <p style="text-align: right;">TM05 1461 2711</p>

Key to support block number

No	Description
1a	Support blocks to be fitted under motor feet
1b	
2a	Support blocks to be fitted under pump housing feet
2b	
3	Support blocks to be fitted under both motor and pump housing feet

Base frames

As an additional feature a base frame for improving the installation is available. The base frame is placed between the foundation and the support blocks.

When ordering a base frame as an accessory, the relevant support blocks, bolts, nuts and washers for mounting of the pump on the base frame are always included. Bolts for mounting the base frame on the foundation are not included.

Product numbers

Information on the pump nameplate will indicate which support block number to choose.

The product numbers in the tables on the following pages refer to one support block. Therefore always order two of the product numbers in the list as the pump/motor needs to be supported on both sides.

Note: Bolts, washers and nuts are not supplied together with support blocks.

If the pump housing of your pump has feet and two options are indicated, choose the one with support blocks for the pump.

If your pump/motor combination is not in the list, contact your Grundfos Customer Service Unit (CSU).

NB, 2-pole, 50 Hz

Pump type	P2 [kW]	Axial height with support blocks	Product number of support block*		Support blocks for pump and/or motor are available for motors marked with "x"					
			Support block under pump	Support block under motor	E-motor	Standard motor				
					MGE IE3	MG IE2	IE3	Siemens IE3	MMG-E IE1	IE2
32-125	3	137	96735813	-	x	x	x	x		x
32-160	5.5	157	96735813	-	x	x	x	x		x
32-200	11	185	96735813	95921203	x		x	x		x
32-250	11	185	95040657	95921203	x	x	x	x		x
32-250	15	185	95040657	95921203	x		x	x		
32-250	15	185	95040657	95921206						x
40-125	3	137	96735813	-	x	x	x	x		x
40-125	4	137	96735813	-	x	x	x	x		x
40-125	5.5	162	97975651	-	x	x	x	x		x
40-160	5.5	157	96735813	-	x	x	x	x		x
40-160	7.5	157	96735813	-	x	x	x	x		x
40-160	11	182	97975651	97975652	x		x	x		x
40-200	11	185	96735813	95921203		x	x			
40-200	11	185	-	95921203	x		x	x		x
40-200	15	185	96735813	95921203		x	x			
40-200	15	185	-	95921203	x		x	x		
40-200	15	185	-	95921206						x
40-250	11	185	95040657	95921203			x			
40-250	11	185	-	95921203	x		x	x		x
40-250	15	185	-	95921203	x		x	x		
40-250	15	185	-	95921206						x
40-250	18.5	185	-	95921203						
40-250	18.5	185	-	95921206	x		x	x		x
40-250	30	205	95040665	95040707				x		
40-250	30	205	-	95040707				x		x
40-315	22	200	-	95921205	x		x	x		x
40-315	30	205	95040657	95040707				x		x
40-315	37	205	95040657	95040707				x		x
40-315	45	230	95040667	95040707				x		x
50-125	5.5	157	96735813	-	x	x	x	x		x
50-125	7.5	157	96735813	-	x	x	x	x		x
50-160	11	185	96735813	95921203			x			
50-160	11	185	-	95921203	x		x	x		x
50-160	15	185	-	95921203	x		x	x		
50-160	15	185	-	95921206						x
50-200	11	185	96735813	95921203	x					
50-200	11	185	-	95921203	x		x	x		x
50-200	15	185	96735813	95921203			x			
50-200	15	185	-	95921203	x		x	x		
50-200	15	185	-	95921206						x
50-200	18.5	185	96735813	95921203						
50-200	18.5	185	96735813	95921206			x			
50-200	18.5	185	-	95921203						
50-200	18.5	185	-	95921206	x		x	x		x
50-200	22	185	96735813	95921204						
50-250	15	185	-	95921203	x		x	x		
50-250	15	185	-	95921206						x
50-250	18.5	185	-	95921203						
50-250	18.5	185	-	95921206	x		x	x		x
50-250	30	205	95040665	95040707				x		x
50-250	30	205	-	95040707				x		x
50-250	37	205	95040665	95040707				x		
50-250	37	205	-	95040707				x		x
50-315	30	225	-	95921208				x		x
50-315	37	225	-	95921208				x		x
50-315	45	230	95040657	95040707				x		x
50-315	55	285	97975653	95921213				x		x
65-125	11	185	95040665	95921203	x		x	x		x
65-160	11	185	95040665	95921203	x		x			
65-160	11	185	-	95921203	x		x	x		x
65-160	15	185	95040665	95921203			x			
65-160	15	185	-	95921203	x		x	x		
65-160	15	185	-	95921206						x

Pump type	P2 [kW]	Axial height with support blocks	Product number of support block*		Support blocks for pump and/or motor are available for motors marked with "x"						
			Support block under pump	Support block under motor	E-motor	Standard motor					
					MGE	MG		Siemens	MMG-E		MMG-H
						IE3	IE2	IE3	IE3	IE1	IE2
65-160	18.5	185	95040665	95921206	x						
65-160	18.5	185	-	95921203							
65-160	18.5	185	-	95921206	x		x	x			x
65-200	11	185	-	95921203	x		x	x			x
65-200	15	185	95040657	95921203			x				
65-200	15	185	-	95921203	x		x	x			
65-200	15	185	-	95921206							x
65-200	18.5	185	95040657	95921206			x				
65-200	18.5	185	-	95921203							
65-200	18.5	185	-	95921206	x		x	x			x
65-200	30	205	95040665	95040707				x			
65-200	30	205	-	95040707				x			x
65-200	37	205	95040665	95040707				x			
65-200	37	205	-	95040707				x			x
65-250	30	205	95040668	95040707				x			x
65-250	37	205	95040668	95040707				x			x
65-250	45	235	95040715	95040708							
65-250	45	235	95040715	95921210				x			x
65-250	55	300	97975654	95921214				x			x
65-250	75	300	97975654	95921216				x			x
65-315	55	285	97975655	95921213				x			x
65-315	75	285	97975655	95921215				x			x
65-315	90	285	97975655	95921217				x			x
65-315	110	345	97975656	95921219				x			x
80-160	11	185	95040657	95921203	x						
80-160	11	185	-	95921203	x		x	x			x
80-160	15	185	95040657	95921203	x						
80-160	15	185	95040657	95921206							x
80-160	15	185	-	95921203	x		x	x			
80-160	15	185	-	95921206							x
80-160	18.5	185	95040657	95921206	x						
80-160	18.5	185	-	95921203							
80-160	18.5	185	-	95921206	x		x	x			x
80-160	30	205	95040665	95040707				x			
80-160	30	205	-	95040707				x			x
80-200	30	205	95040665	95040707				x			x
80-200	37	205	95040665	95040707				x			x
80-200	45	230	95921123	95040707				x			x
80-200	55	280	97975657	95921212				x			x
80-250	45	235	95040715	95040708							
80-250	45	235	95040715	95921210				x			x
80-250	55	300	97975654	95921214				x			x
80-250	75	300	97975654	95921216				x			x
80-250	90	300	97975654	95921291				x			x
80-315	90	285	95040715	95921217				x			x
80-315	110	350	97975654	95921220				x			x
80-315	132	350	97975654	95921223				x			x
80-315	160	350	97975654	95921223				x			x
80-315	160	350	97975654	95921225				x			
100-160	18.5	200	-	98283087	x						
100-160	22	200	-	95921205	x		x	x			x
100-160	30	205	95040668	95040707				x			x
100-160	37	205	95040668	95040707				x			x
100-200	30	205	95040668	95040707				x			x
100-200	37	205	95040668	95040707				x			x
100-200	45	235	95040715	95040708							
100-200	45	235	95040715	95921210				x			x
100-200	55	300	97975654	95921214				x			x
100-200	75	300	97975654	95921216				x			x
100-250	55	285	97975655	95921213				x			x
100-250	75	285	97975655	95921215				x			x
100-250	90	285	97975655	95921217				x			x
100-250	110	345	97975656	95921219				x			x
100-250	132	345	97975656	95921222				x			x
100-315	110	350	97975654	95921220				x			x

Pump type	P2 [kW]	Axial height with support blocks	Product number of support block*		Support blocks for pump and/or motor are available for motors marked with "x"						
			Support block under pump	Support block under motor	E-motor	Standard motor					
					MGE IE3	MG IE2	IE3	Siemens IE3	MMG-E IE1	IE2	MMG-H IE2/IE3
100-315	132	350	97975654	95921223				x			x
100-315	160	350	97975654	95921223							x
100-315	160	350	97975654	95921225				x			
100-315	200	350	97975654	95921223							x
100-315	200	350	97975654	95921225				x			
125-200	45	250	-	95921209				x			x
125-200	45	285	95040715	95921260							
125-200	55	285	95040715	95921213				x			x
125-200	75	285	95040715	95921215				x			x
125-200	90	285	95040715	95921217				x			x
125-200	110	350	97975654	95921220				x			x
125-250	90	285	95040715	95921217				x			x
125-250	110	350	97975654	95921220				x			x
125-250	132	350	97975654	95921223				x			x
125-250	160	350	97975654	95921223							x
125-250	160	350	97975654	95921225				x			
125-250	200	350	97975654	95921223							x
125-250	200	350	97975654	95921225				x			
125-315	132	340	97975658	95921221				x			x
125-315	160	340	97975658	95921221							x
125-315	160	340	97975658	95921224				x			
125-315	200	340	97975658	95921221							x
125-315	200	340	97975658	95921224				x			
150-200	110	340	97975658	95921218				x			x
150-250	132	340	97975658	95921221				x			x
150-250	160	340	97975658	95921221							x
150-250	160	340	97975658	95921224				x			
150-250	200	340	97975658	95921221							x
150-250	200	340	97975658	95921224				x			
150-315.2	160	335	98189152	97994327				x	x	x	x
150-315.2	200	335	98189152	97994327				x	x	x	x
150-315	160	340	97975658	95921221						x	x
150-315	160	340	97975658	95921224				x			
150-315	160	340	97975658	-					x		
150-315	200	340	97975658	95921221						x	x
150-315	200	340	97975658	95921224				x			
150-315	200	340	97975658	-					x		

* Always order two of the product numbers in the list as the pump/motor needs to be supported on both sides.

NB, 4-pole, 50 Hz

Pump type	P2 [kW]	Axial height with support blocks	Product number of support block*		Support blocks for pump and/or motor are available for motors marked with "x"								
					E-motor		Standard motor						
			Support block under pump	Support block under motor	MGE		MG		Siemens	MMG-E	MMG-G		MMG-H
					IE1	IE2	IE2	IE3	IE3	IE2	IE1	IE2	IE2/IE3
50-315	11	240	95040662	95921247		x			x				x
50-315	11	240	95040662	95921253				x					
65-315	11	240	95040671	95921247		x			x				x
65-315	11	240	95040671	95921253				x					
65-315	15	240	95040671	95921247		x							
65-315	15	240	95040671	95921253				x	x				x
80-250	11	200	-	95921246		x	x		x				x
80-250	11	200	-	98283087				x					
80-315	11	260	95040670	95921249		x			x				x
80-315	11	260	95040670	95921255				x					
80-315	15	260	95040670	95921249		x							
80-315	15	260	95040670	95921255				x	x				x
80-315	18.5	260	95040670	95921251		x			x				x
80-315	22	260	95040670	95921251					x				
80-315	22	260	95040670	95921256									x
80-400	18.5	280	-	95921252		x			x				x
80-400	22	280	-	95921252					x				
80-400	22	280	-	95921257									x
80-400	30	300	95040712	95921263					x				x
80-400	37	285	95040668	95921260					x				x
80-400	45	280	-	98042221									x
80-400	45	285	95040668	95921260					x				
100-200	11	200	-	95921246		x	x		x				x
100-200	11	200	-	98283087				x					
100-250	11	240	95040671	95921247		x			x				x
100-250	11	240	95040671	95921253				x					
100-250	15	240	95040671	95921247		x							
100-250	15	240	95040671	95921253				x	x				x
100-315	15	260	95040670	95921249		x							
100-315	15	260	95040670	95921255				x	x				x
100-315	18.5	260	95040670	95921251		x			x				x
100-315	22	260	95040670	95921251					x				
100-315	22	260	95040670	95921256									x
100-315	30	260	95040670	95921262					x				x
100-400	22	280	-	95921252					x				
100-400	22	280	-	95921257									x
100-400	30	300	95040720	95921263					x				x
100-400	37	285	95040718	95921260					x				x
100-400	45	280	-	98042221									x
100-400	45	285	95040718	95921260					x				
100-400	55	280	-	95921212					x				x
125-200	11	260	95040670	95921249		x	x		x				x
125-200	11	260	95040670	95921255				x					
125-200	15	260	95040670	95921249		x							
125-200	15	260	95040670	95921255				x	x				x
125-250	11	260	95040670	95921249		x			x				x
125-250	11	260	95040670	95921255				x					
125-250	15	260	95040670	95921249		x							
125-250	15	260	95040670	95921255				x	x				x
125-250	18.5	260	95040670	95921251		x			x				x
125-250	22	260	95040670	95921251					x				
125-250	22	260	95040670	95921256									x
125-250	30	260	95040670	95921262					x				x
125-315	18.5	280	-	95921252		x			x				x
125-315	22	280	-	95921252					x				
125-315	22	280	-	95921257									x
125-315	30	300	95040720	95921263					x				x
125-315	37	285	95040718	95921260					x				x
125-315	45	280	-	98042221									x
125-315	45	285	95040718	95921260					x				
125-400	37	325	95040719	95921261					x				x
125-400	45	325	95040719	95921261					x				
125-400	45	325	95040719	95921273									x

Pump type	P2 [kW]	Axial height with support blocks	Product number of support block*		Support blocks for pump and/or motor are available for motors marked with "x"								
					E-motor		Standard motor						
			Support block under pump	Support block under motor	MGE		MG		Siemens	MMG-E	MMG-G		MMG-H
					IE1	IE2	IE2	IE3	IE3	IE2	IE1	IE2	IE2/IE3
125-400	55	315	-	97975659					x				x
125-400	75	315	-	95921265					x				x
125-400	90	315	-	95921265					x				
125-400	90	315	-	95921268									x
125-500	55	400	-	98042212					x				x
125-500	75	400	-	95921282					x				x
125-500	90	400	-	95921282					x				
125-500	90	400	-	95921283									x
125-500	110	400	-	98042216					x				x
125-500	132	400	-	98042220									x
125-500	132	435	95921301	95921270					x				
125-500	160	400	-	98042220					x				x
150-200	11	300	95040720	95921248		x			x				x
150-200	11	300	95040720	95921254				x					
150-200	15	300	95040720	95921248		x							
150-200	15	300	95040720	95921254				x	x				x
150-250	15	300	95040720	95921248		x							
150-250	15	300	95040720	95921254				x	x				x
150-250	18.5	280	-	95921252	x				x				x
150-250	22	280	-	95921252					x				
150-250	22	280	-	95921257									x
150-250	30	300	95040720	95921263					x				x
150-250	37	285	95040718	95921260					x				x
150-250	45	280	-	98042221									x
150-250	45	285	95040718	95921260					x				
150-315.2	22	280	-	95921257					x	x	x	x	x
150-315.2	30	300	95921120	95921263					x	x	x	x	x
150-315.2	37	290	95921120	95921061					x				x
150-315.2	37	290	95921120	95921073					x	x	x		
150-315.2	45	290	95921120	95921061					x				x
150-315.2	45	290	95921120	95921073					x	x	x		
150-315.2	55	315	-	95921136					x	x			x
150-315.2	55	315	-	95921137						x	x		
150-315.2	75	315	-	95921065					x	x			x
150-315.2	75	315	-	95921075						x	x		
150-315	37	290	95921120	95921059					x	x	x	x	x
150-315	45	290	95921120	95921061					x				
150-315	45	290	95921120	95921073					x	x	x		x
150-315	55	315	-	95921136					x	x			x
150-315	55	315	-	95921137						x	x		
150-315	75	315	-	95921065					x	x			x
150-315	75	315	-	95921075						x	x		
150-315	90	315	-	95921068					x	x			x
150-315	90	315	-	95921077						x	x		
150-400	55	315	-	97975659					x				x
150-400	75	315	-	95921265					x				x
150-400	90	315	-	95921265					x				
150-400	90	315	-	95921268									x
150-400	110	335	95040720	97994325					x				x
150-400	132	335	95040720	97994327									x
150-400	132	335	95040720	-					x				
150-400	160	335	95040720	97994327					x				x
150-500	132	400	-	98042220									x
150-500	132	435	95921301	95921270					x				
150-500	160	400	-	98042220					x				x
150-500	200	400	-	98042220					x				x
200-400	37	400	-	98042208					x				x
200-400	45	400	-	98042208					x				
200-400	45	400	-	98042233									x
200-400	55	400	-	98042212					x				x
200-400	75	400	-	95921282					x				x
200-400	90	400	-	95921282					x				
200-400	90	400	-	95921283									x
200-400	110	400	-	98042216					x				x
200-400	132	400	-	98042220									x

Pump type	P2 [kW]	Axial height with support blocks	Product number of support block*		Support blocks for pump and/or motor are available for motors marked with "x"								
					E-motor		Standard motor						
			Support block under pump	Support block under motor	MGE		MG		Siemens	MMG-E	MMG-G		MMG-H
					IE1	IE2	IE2	IE3	IE3	IE2	IE1	IE2	IE2/IE3
200-400	132	435	95921301	95921270					x				
200-450	75	400	-	95921282					x				x
200-450	90	400	-	95921282					x				
200-450	90	400	-	95921283									x
200-450	110	400	-	98042216					x				x
200-450	132	400	-	98042220									x
200-450	132	435	95921301	95921270					x				
200-450	160	400	-	98042220					x				x
250-350	37	450	-	98042207					x				x
250-350	45	450	-	98042207					x				
250-350	45	450	-	98042231									x
250-350	55	450	-	98042192					x				x
250-350	75	450	-	98042213					x				x
250-350	90	450	-	98042213					x				
250-350	90	450	-	98042218									x
250-400	45	450	-	98042207					x				
250-400	45	450	-	98042231									x
250-400	55	450	-	98042192					x				x
250-400	75	450	-	98042213					x				x
250-400	90	450	-	98042213					x				
250-400	90	450	-	98042218									x
250-400	110	450	-	98042215					x				x
250-400	132	450	-	98042219									x
250-400	160	450	-	98042219					x				x
250-450	75	450	-	98042213					x				x
250-450	90	450	-	98042213					x				
250-450	90	450	-	98042218									x
250-450	110	450	-	98042215					x				x
250-450	132	450	-	98042219									x
250-450	160	450	-	98042219					x				x
250-450	200	450	-	98042219					x				x
250-500	160	450	-	98042219					x				x
250-500	200	450	-	98042219					x				x

* Always order two of the product numbers in the list as the pump/motor needs to be supported on both sides.

NB, 6-pole, 50 Hz

Pump type	P2 [kW]	Axial height with support blocks	Product number of support block*		Support blocks for pump and/or motor are available for motors marked with "x"			
			Support block under pump	Support block under motor	Standard motor			
					Siemens IE3	MMG-E IE2	MMG-G IE2	MMG-H IE2/IE3
100-315	7.5	260	95040670	95921249	x			
100-315	11	260	95040670	95921255	x			x
100-400	7.5	300	95040720	95921248	x			
100-400	11	300	95040720	95921254	x			x
100-400	15	280	-	95921252	x			
100-400	15	280	-	95921257				x
125-250	7.5	260	95040670	95921249	x			
125-315	7.5	300	95040720	95921248	x			
125-315	11	300	95040720	95921254	x			x
125-315	15	280	-	95921252	x			
125-315	15	280	-	95921257				x
125-400	11	320	95040718	95921284	x			x
125-400	15	320	95040718	95921285				x
125-400	15	320	95040718	98189154	x			
125-400	18.5	320	95040718	95921287	x			x
125-400	22	320	95040718	95921287	x			x
125-400	30	325	95040719	95921261	x			
125-400	30	325	95040719	95921273				x
125-500	18.5	400	-	97975660	x			x
125-500	22	400	-	97975660	x			x
125-500	30	400	-	98042208	x			
125-500	30	400	-	98042233				x
125-500	37	400	-	98042212	x			x
125-500	45	400	-	95921282	x			x
125-500	55	400	-	95921282	x			
125-500	55	400	-	95921283				x
150-250	7.5	300	95040720	95921248	x			
150-250	11	300	95040720	95921254	x			x
150-315.2	7.5	300	95921120	95921248	x	x	x	x
150-315.2	11	285	95921119	95921084	x	x	x	x
150-315.2	15	285	95921119	95921085	x	x	x	x
150-315.2	18.5	285	95921119	95921087	x	x	x	x
150-315	11	285	95921119	95921084	x	x	x	x
150-315	15	285	95921119	95921085	x	x	x	x
150-315	18.5	285	95921119	95921087	x	x	x	x
150-315	22	285	95921119	95921087	x	x	x	x
150-315	30	290	95921120	95921061	x			
150-315	30	290	95921120	95921073		x	x	x
150-400	18.5	320	95040718	95921287	x			x
150-400	22	320	95040718	95921287	x			x
150-400	30	325	95040719	95921261	x			
150-400	30	325	95040719	95921273				x
150-400	30	325	-	-				
150-400	37	315	-	97975659	x			x
150-400	45	315	-	95921265	x			x
150-500	37	400	-	98042212	x			x
150-500	45	400	-	95921282	x			x
150-500	55	400	-	95921282	x			
150-500	55	400	-	95921283				x
150-500	75	400	-	98042216	x			x
200-400	15	400	-	98042205				x
200-400	18.5	400	-	97975660	x			x
200-400	22	400	-	97975660	x			x
200-400	30	400	-	98042208	x			
200-400	30	400	-	98042233				x
200-400	37	400	-	98042212	x			x
200-450	18.5	400	-	97975660	x			x
200-450	22	400	-	97975660	x			x
200-450	30	400	-	98042208	x			
200-450	30	400	-	98042233				x
200-450	37	400	-	98042212	x			x
200-450	45	400	-	95921282	x			x
250-350	11	450	-	98042191	x			x

Pump type	P2 [kW]	Axial height with support blocks	Product number of support block*		Support blocks for pump and/or motor are available for motors marked with "x"			
					Standard motor			
			Support block under pump	Support block under motor	Siemens IE3	MMG-E IE2	MMG-G IE2	MMG-H IE2/IE3
250-350	15	450	-	98042189				x
250-350	18.5	450	-	98042210	x			x
250-350	22	450	-	98042210	x			x
250-400	15	450	-	98042189				x
250-400	18.5	450	-	98042210	x			x
250-400	22	450	-	98042210	x			x
250-400	30	450	-	98042207	x			
250-400	30	450	-	98042231				x
250-400	37	450	-	98042192	x			x
250-400	45	450	-	98042213	x			x
250-450	18.5	450	-	98042210	x			x
250-450	22	450	-	98042210	x			x
250-450	30	450	-	98042207	x			
250-450	30	450	-	98042231				x
250-450	37	450	-	98042192	x			x
250-450	45	450	-	98042213	x			x
250-450	55	450	-	98042213	x			
250-450	55	450	-	98042218				x
250-500	45	450	-	98042213	x			x
250-500	55	450	-	98042213	x			
250-500	55	450	-	98042218				x
250-500	75	450	-	98042215	x			x
250-500	90	450	-	98042219				

* Always order two of the product numbers in the list as the pump/motor needs to be supported on both sides.

Certificates and reports

Grundfos offers a number of certificates and reports. When a customer wants a certificate or a report, the request must be stated on the order.

The certificate or report will then be put onto the bill of materials and thus included in the product number of the pump.

Certificates or reports have to be confirmed for every order.

For more information on certificates and reports, see the data booklet "NB, NBG, NK, NKG, NBE, NBGE, NKE, NKGE - Custom-built pumps according to EN 733 and ISO 2858".

Short description	Standard
Certificate of compliance with the order	EN 10204 - 2.1
Grundfos document certifying that the pump supplied is in compliance with the order specifications.	
Test certificate - Non-specific inspection and testing	EN 10204 - 2.2
Certificate with inspection and test results of a non-specific pump	
Inspection certificate - Grundfos authorized department	EN 10204 - 3.1
Grundfos document certifying that the pump supplied is in compliance with the order specifications. Inspection and test results are mentioned in the certificate.	
Inspection certificate - External classifying society	EN 10204 - 3.2
Grundfos document certifying that the pump supplied is in compliance with the order specifications. Inspection and test results are mentioned in the certificate. Certificate from the surveyor is included:	
Lloyds Register EMEA (LR)	3.2
Inspection certificate DNV-GL	3.2
Bureau Veritas (BV)	3.2
American Bureau of Shipping (ABS)	3.2
Registro Italiano Navale Agenture (RINA)	3.2
China Class. Society (CCS)	3.2
Russian Maritime Register (RS)	3.2
Biro Klas. Indonesia (BKI)	3.2
United States Coast Guard (USCG)	3.2
Nippon Kaiji Koykai (NKK)	3.2
Pump performance - Curve test report	ISO 9906:2012
Performance curve test report - Grade 3B	
Pump performance - Duty point verification report	ISO 9906:2012
Duty point verification report - Grade 3B, Q&H	
Duty point verification report - Grade 3B, Q&H + Eta total	
Duty point verification report - Grade 3B, Q&H + P1	
Duty point verification report - Grade 2B, Q&H	
Duty point verification report - Grade 2B, Q&H + Eta total	
Duty point verification report - Grade 2B, Q&H + P1	
Duty point verification report - Grade 2U, Q&H	
Duty point verification report - Grade 2U, Q&H + Eta total	
Duty point verification report - Grade 2U, Q&H + P1	
Duty point verification report - Grade 1B, Q&H	
Duty point verification report - Grade 1B, Q&H + Eta total	
Duty point verification report - Grade 1B, Q&H + P1	
Duty point verification report - Grade 1E, Q&H	
Duty point verification report - Grade 1E, Q&H + Eta total	
Duty point verification report - Grade 1E, Q&H + P1	
Duty point verification report - Grade 1U, Q&H	
Duty point verification report - Grade 1U, Q&H + Eta total	
Duty point verification report - Grade 1U, Q&H + P1	
Other certificates/Reports	
Material specification report	
Material specification report + certificate from raw material supplier	
ATEX approved pump report	
PWIS-free certificate	
Vibration report	ISO 5199
Vibration report	ISO 10816
Impeller balancing report Grade 6.3	ISO 1940

22. Service

Some pump parts will become worn over time and need to be replaced. These parts can be ordered as service kits.

Service recommendations

To avoid unnecessary downtime, we recommend that you stock certain service parts. These service parts should be ordered together with the pump.

Information about service kits and recommended service parts can be found in the service kit catalogue.

In Grundfos Product Center, you can also search for the "Service offerings" data booklet, which gives relevant information about service issues.

23. Grundfos Product Center

Online search and sizing tool to help you make the right choice.

<http://product-selection.grundfos.com>



Select between "Products" and "Literature" when searching for the document.

"SIZING" enables you to size a pump based on entered data and selection choices.

"REPLACEMENT" enables you to find a replacement product. Search results will include information on the following:

- the lowest purchase price
- the lowest energy consumption
- the lowest total life cycle cost.

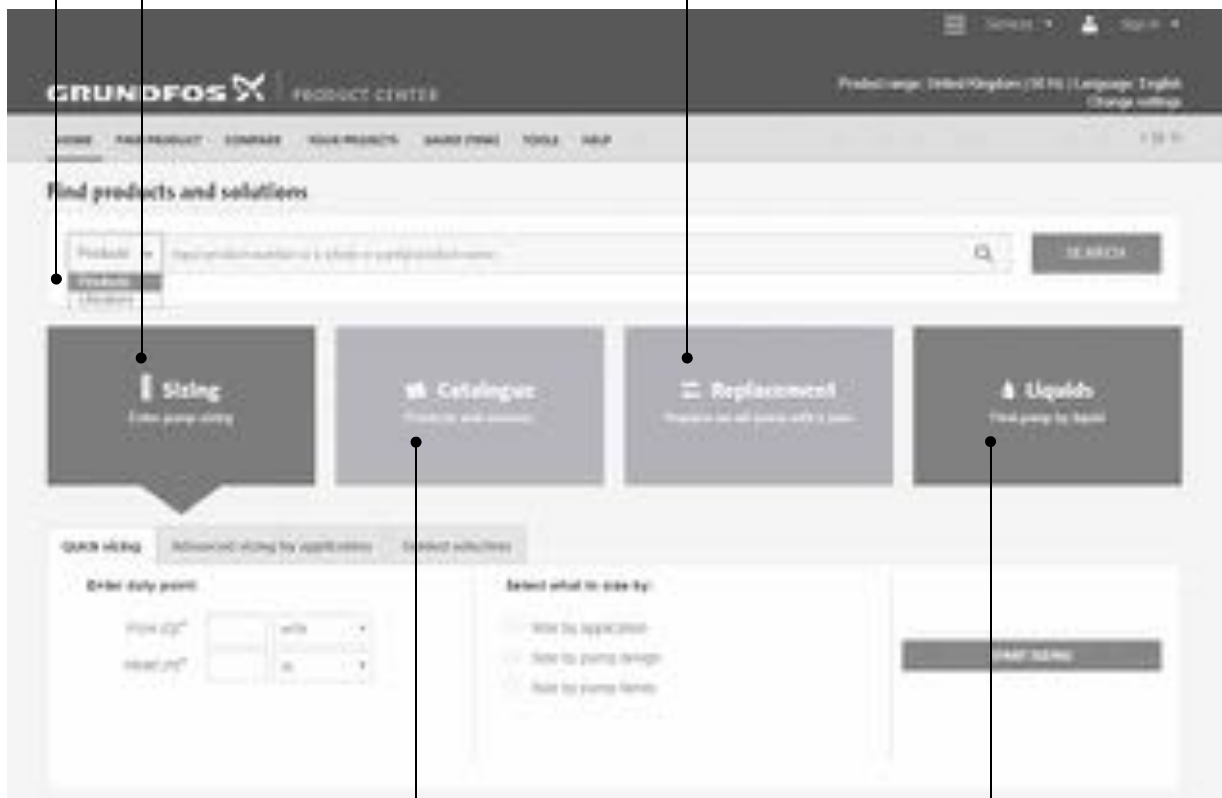

"CATALOGUE" gives you access to the Grundfos product catalogue.

"LIQUIDS" enables you to find pumps designed for aggressive, flammable or other special liquids.

All the information you need in one place

Performance curves, technical specifications, pictures, dimensional drawings, motor curves, wiring diagrams, spare parts, service kits, 3D drawings, documents, system parts. The Product Center displays any recent and saved items - including complete projects - right on the main page.

Downloads

On the product pages, you can download installation and operating instructions, data booklets, service instructions, etc. in PDF format.

96653947 0119

ECM: 1249192

GRUNDFOS A/S
DK-8850 Bjerringbro . Denmark
Telephone: +45 87 50 14 00
www.grundfos.com

GRUNDFOS 