

Qty.	Description
------	-------------

1	CRN 1-4 A-CA-A-V-HQQV
---	-----------------------



Product No.: [96557471](#)

Vertical, multistage centrifugal pump with inlet and outlet ports on same the level (inline). Pump materials in contact with the liquid are in high-grade stainless steel. A cartridge shaft seal ensures high reliability, safe handling, and easy access and service. Power transmission is via a rigid split coupling. Pipe connection is via FlexiClamps.

The pump is fitted with a 1-phase, fan-cooled asynchronous motor.

Further product details

Steel, cast iron and aluminium components have an epoxy-based coating made in a cathodic electro-deposition (CED) process.

CED is a high-quality dip-painting process where an electrical field around the products ensures deposition of paint particles as a thin, well-controlled layer on the surface.

An integral part of the process is a pretreatment.

The entire process consists of these elements:

- 1) Alkaline-based cleaning.
- 2) Zinc phosphating.
- 3) Cathodic electro-deposition.
- 4) Curing to a dry film thickness 18-22 my m.

The colour code for the finished product is NCS 9000/RAL 9005.

Pump

A standard split coupling connects the pump and motor shaft. It is enclosed in the pump head/motor stool by means of two coupling guards.

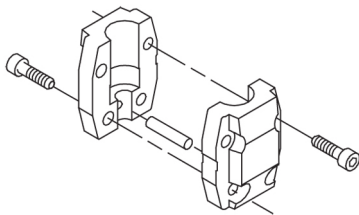

The pump head and flange for motor mounting is made in one piece (cast iron). The pump head cover is a separate component (stainless steel). The pump head has a combined 1/2" priming plug and vent screw.

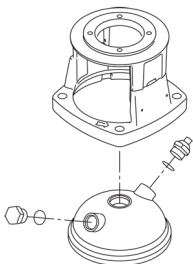

The pump is fitted with a balanced O-ring seal unit with a rigid torque-transmission system.

This seal type is assembled in a cartridge unit which makes replacement safe and easy.

Due to the balancing, this seal type is suitable for high-pressure applications.

Qty. Description

The cartridge construction also protects the pump shaft from possible wear from a dynamic O-ring between pump shaft and shaft seal.

Primary seal:

- Rotating seal ring material: silicon carbide (SiC)
- Stationary seat material: silicon carbide (SiC)

This material pairing is used where higher corrosion resistance is required. The high hardness of this material pairing offers good resistance against abrasive particles.

Secondary seal material: FKM (fluorocarbon rubber)

FKM has excellent resistance to oils and chemicals. Above 90 °C, FKM should only be used in media without water.

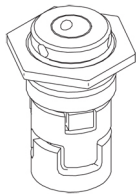

The shaft seal is screwed into the pump head.

The chambers and impellers are made of stainless-steel sheet. The chambers are provided with a PTFE neck ring offering improved sealing and high efficiency. The impellers have smooth surfaces, and the shape of the blades ensure a high efficiency.

The pump has a stainless-steel base mounted on a separate base plate.

The base and base plate are kept in position by the tension of the staybolts which hold the pump together.

The outlet side of the base has a combined drain plug and bypass valve.

The pump is secured to the foundation by four bolts through the base plate.

The base is prepared for connection by means of FlexiClamp couplings.

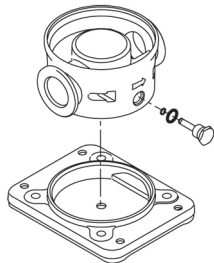

Motor

The motor is a totally enclosed, fan-cooled motor with principal dimensions to IEC and DIN standards. The motor is flange-mounted with tapped-hole flange (FT).

Motor-mounting designation in accordance with IEC 60034-7: IM B 14 (Code I) / IM 3601 (Code II).

Electrical tolerances comply with IEC 60034.

The motor has built-in thermal protection (PTO current and temperature sensors) in accordance with IEC 60034-11 and requires no further motor protection. The protection reacts to both slow- and quick-rising temperatures, e.g. constant overload and stalled conditions.

As the thermal protection incorporates automatic reset, the motor must be connected in a way which ensures that the automatic reset cannot cause accidents.

Technical data

Liquid:

Pumped liquid: Water

Liquid temperature range: -20 .. 90 °C

Selected liquid temperature: 20 °C

Density: 998.2 kg/m³

Technical:

Pump speed on which pump data are based: 2757 rpm

Qty.	Description
	<p>Rated flow: 1.8 m³/h Rated head: 19.8 m Pump orientation: Vertical Shaft seal arrangement: Single Code for shaft seal: HQQV Approvals on nameplate: CE,EAC,UKCA,WRAS Curve tolerance: ISO9906:2012 3B</p> <p>Materials:</p> <p>Base: Stainless steel EN 1.4408 AISI 316</p> <p>Impeller: Stainless steel EN 1.4401 AISI 316</p> <p>Bearing: SIC SIC</p> <p>Installation:</p> <p>Maximum ambient temperature: 40 °C Maximum operating pressure: 25 bar Max pressure at stated temp: 25 bar / 90 °C 25 bar / -20 °C</p> <p>Type of connection: FlexiClamp Size of inlet connection: DN 32 Size of outlet connection: DN 32 Pressure rating for connection: PN 25 Flange size for motor: FT85</p> <p>Electrical data:</p> <p>Motor standard: IEC Motor type: 71B Rated power - P2: 0.37 kW Power (P2) required by pump: 0.37 kW Mains frequency: 50 Hz Rated voltage: 1 x 220-230/240 V Rated current: 2.95/2.70 A Starting current: 280 % Cos phi - power factor: 0.99 Rated speed: 2770 rpm Motor efficiency at full load: 60.0-56.0 % Number of poles: 2 Enclosure class (IEC 34-5): 55 Dust/Jetting Insulation class (IEC 85): F Motor No: 85215102</p> <p>Controls:</p> <p>Frequency converter: NONE</p> <p>Others:</p> <p>Minimum efficiency index, MEI ≥: 0.70 Net weight: 17.7 kg Gross weight: 20.4 kg Shipping volume: 0.054 m³ Country of origin: AU Custom tariff no.: 8413709062</p>

96557471 CRN 1-4 A-CA-A-V-HQQV 50 Hz

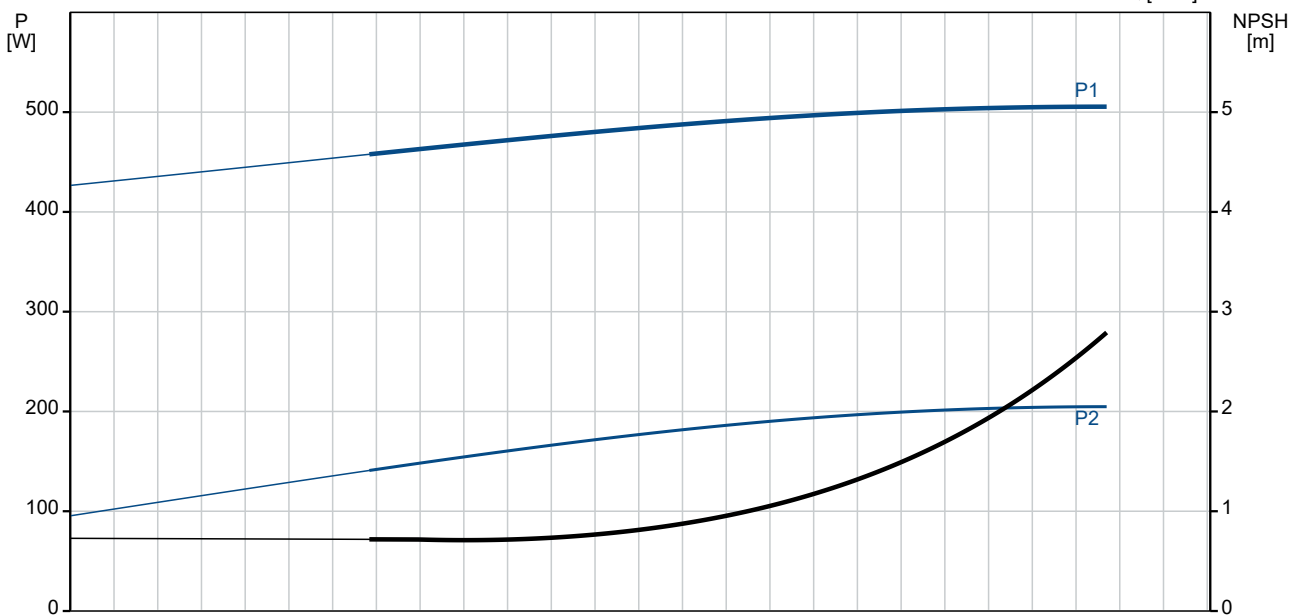
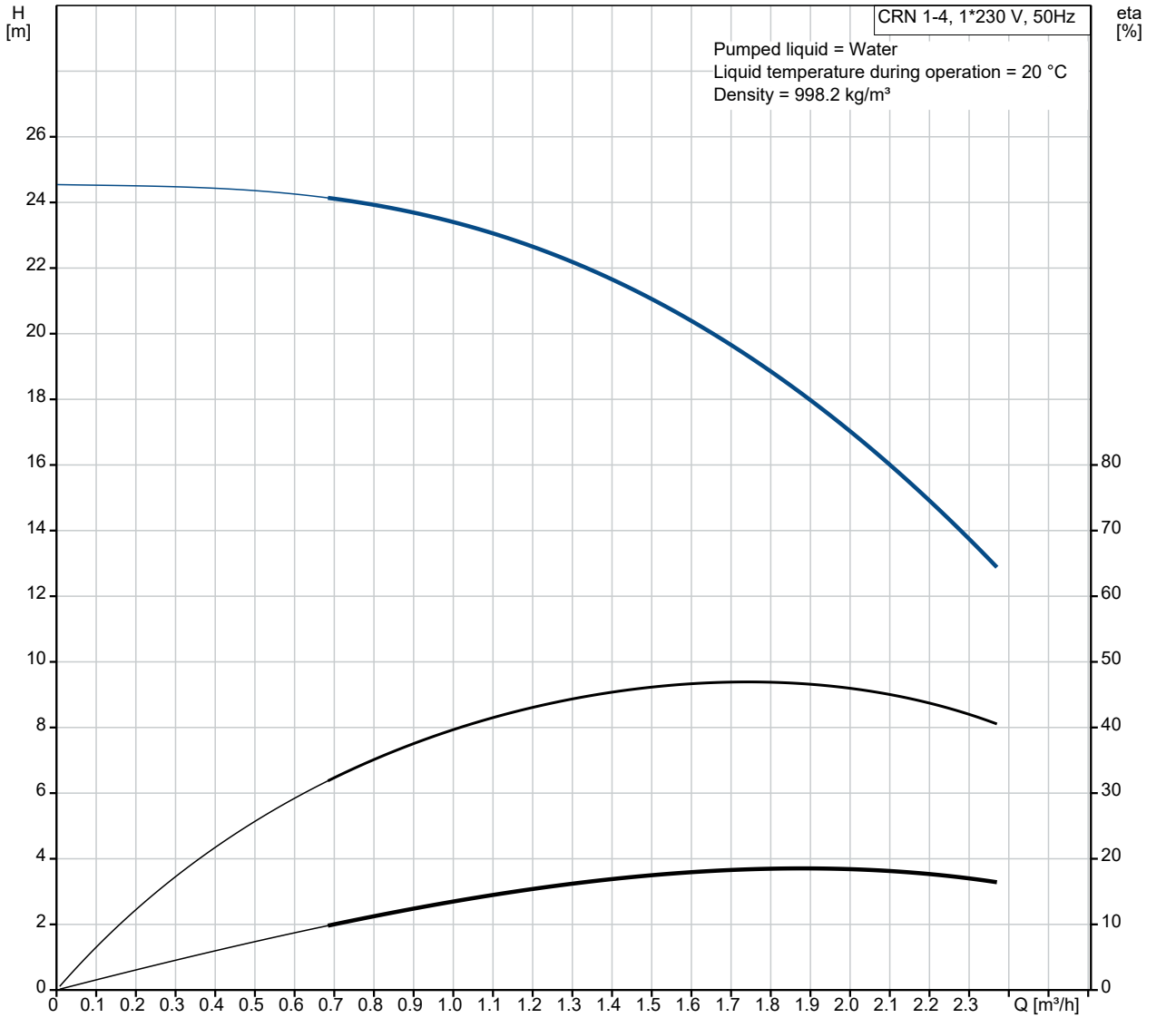

Description	Value
General information:	
Product name:	CRN 1-4 A-CA-A-V-HQQV
Product No:	96557471
EAN number:	5700399082605
Price:	
Technical:	
Pump speed on which pump data are based:	2757 rpm
Rated flow:	1.8 m ³ /h
Rated head:	19.8 m
Maximum head:	25.2 m
Stages:	4
Impellers:	4
Number of reduced-diameter impellers:	0
Low NPSH:	N
Pump orientation:	Vertical
Shaft seal arrangement:	Single
Code for shaft seal:	HQQV
Approvals on nameplate:	CE,EAC,UKCA,WRAS
Curve tolerance:	ISO9906:2012 3B
Pump version:	A
Model:	A
Materials:	
Base:	Stainless steel
Base:	EN 1.4408
Base:	AISI 316
Impeller:	Stainless steel
Impeller:	EN 1.4401
Impeller:	AISI 316
Material code:	A
Code for rubber:	V
Bearing:	SIC
Bearing:	SIC
Installation:	
Maximum ambient temperature:	40 °C
Maximum operating pressure:	25 bar
Max pressure at stated temp:	25 bar / 90 °C
Max pressure at stated temp:	25 bar / -20 °C
Type of connection:	FlexiClamp
Size of inlet connection:	DN 32
Size of outlet connection:	DN 32
Pressure rating for connection:	PN 25
Flange size for motor:	FT85
Connect code:	CA
Liquid:	
Pumped liquid:	Water
Liquid temperature range:	-20 .. 90 °C
Selected liquid temperature:	20 °C
Density:	998.2 kg/m ³
Electrical data:	
Motor standard:	IEC
Motor type:	71B
Rated power - P2:	0.37 kW
Power (P2) required by pump:	0.37 kW
Mains frequency:	50 Hz
Rated voltage:	1 x 220-230/240 V
Rated current:	2.95/2.70 A
Starting current:	280 %

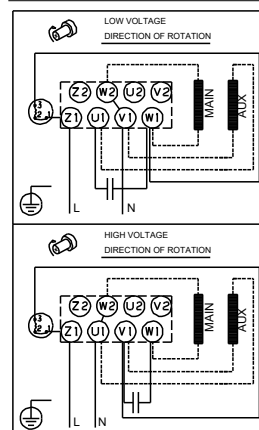
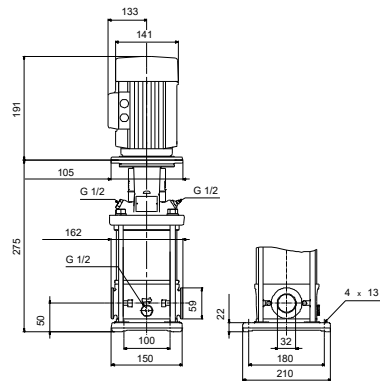
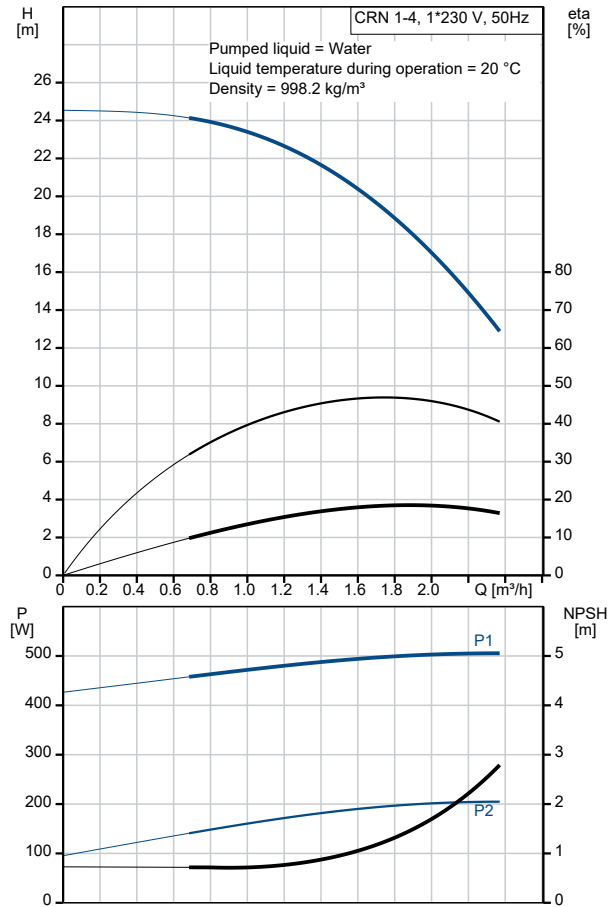



Company name:

Created by:

Phone:

Date:

15/04/2021

Description	Value
Cos phi - power factor:	0.99
Rated speed:	2770 rpm
Motor efficiency at full load:	60.0-56.0 %
Number of poles:	2
Enclosure class (IEC 34-5):	55 Dust/Jetting
Insulation class (IEC 85):	F
Motor protec:	PTO
Motor No:	85215102
Controls:	
Frequency converter:	NONE
Others:	
Minimum efficiency index, MEI ≥:	0.70
Net weight:	17.7 kg
Gross weight:	20.4 kg
Shipping volume:	0.054 m ³
Country of origin:	AU
Custom tariff no.:	8413709062

96557471 CRN 1-4 A-CA-A-V-HQQV 50 Hz

