

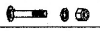







Serial No.:

5626

Installation Instruction

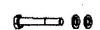
① M10 x 65 bolt, washer, nut  x 8	② M10 x 95 bolt, nut, washer  x 4	③ M10 x 90 bolt, nut, washer  x 8	④ Threaded bolt (10*85)  x 4
⑤ M10 x 95 bolt, washer  x 6	⑥ M10 x 80 bolt, nut, washer  x 4	⑦ M10 x 85 bolt, nut, washer  x 4	⑧ M10 x 16 bolt, nut, washer  x 10

1

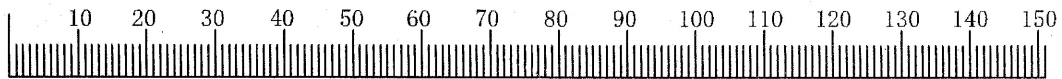
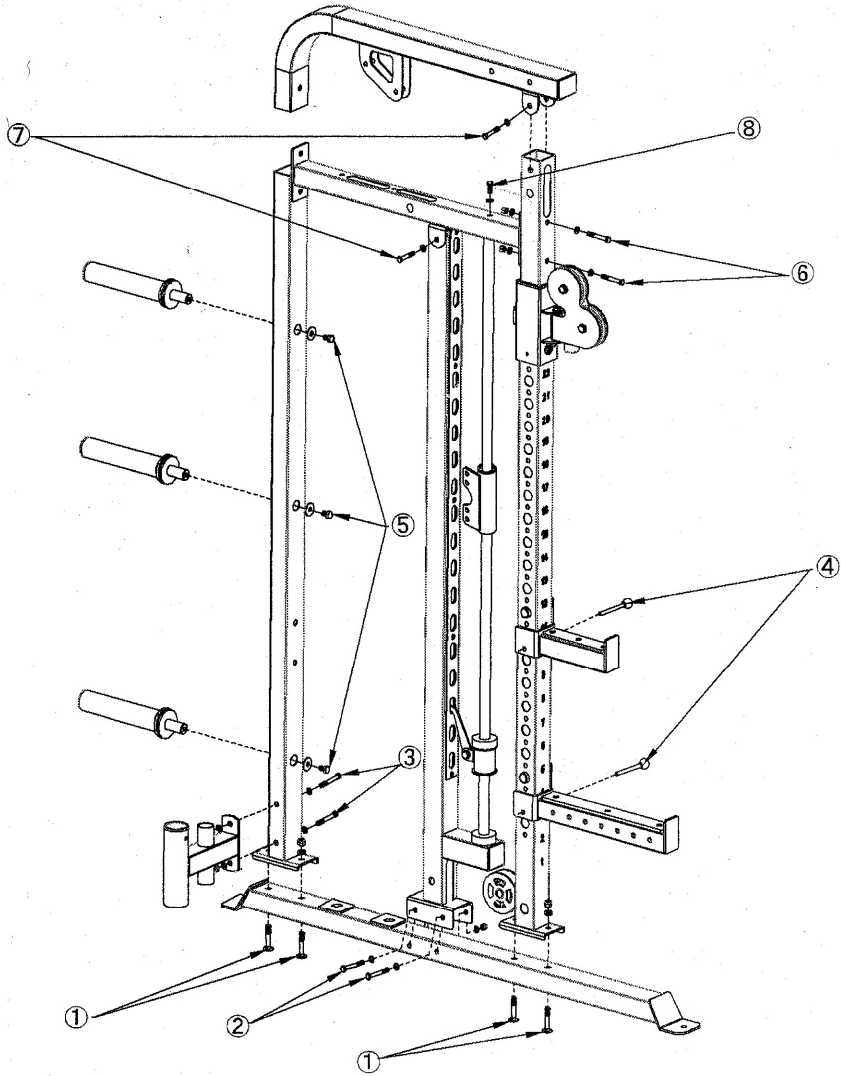

Millimeters

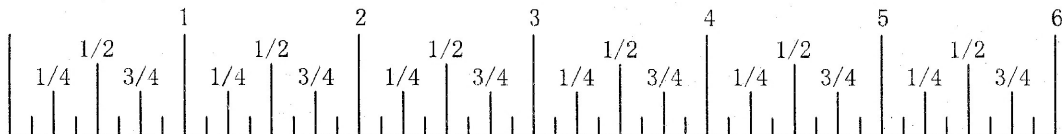



Inches

Serial No.:

5626

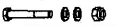
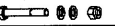
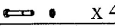
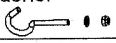
Installation Instruction

① M10 x 75 bolt, washer, nut  x 8	② M10 x 80 bolt, nut, washer  x 4	③ M8 x 65 bolt, nut, washer  x 4	④ M10 nut, washer  x 5
⑤ cushion  x 8	⑥ pinch-cock  x 4		

2

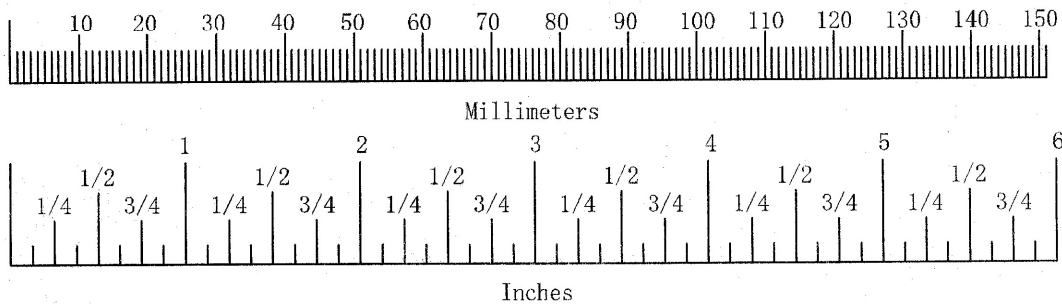
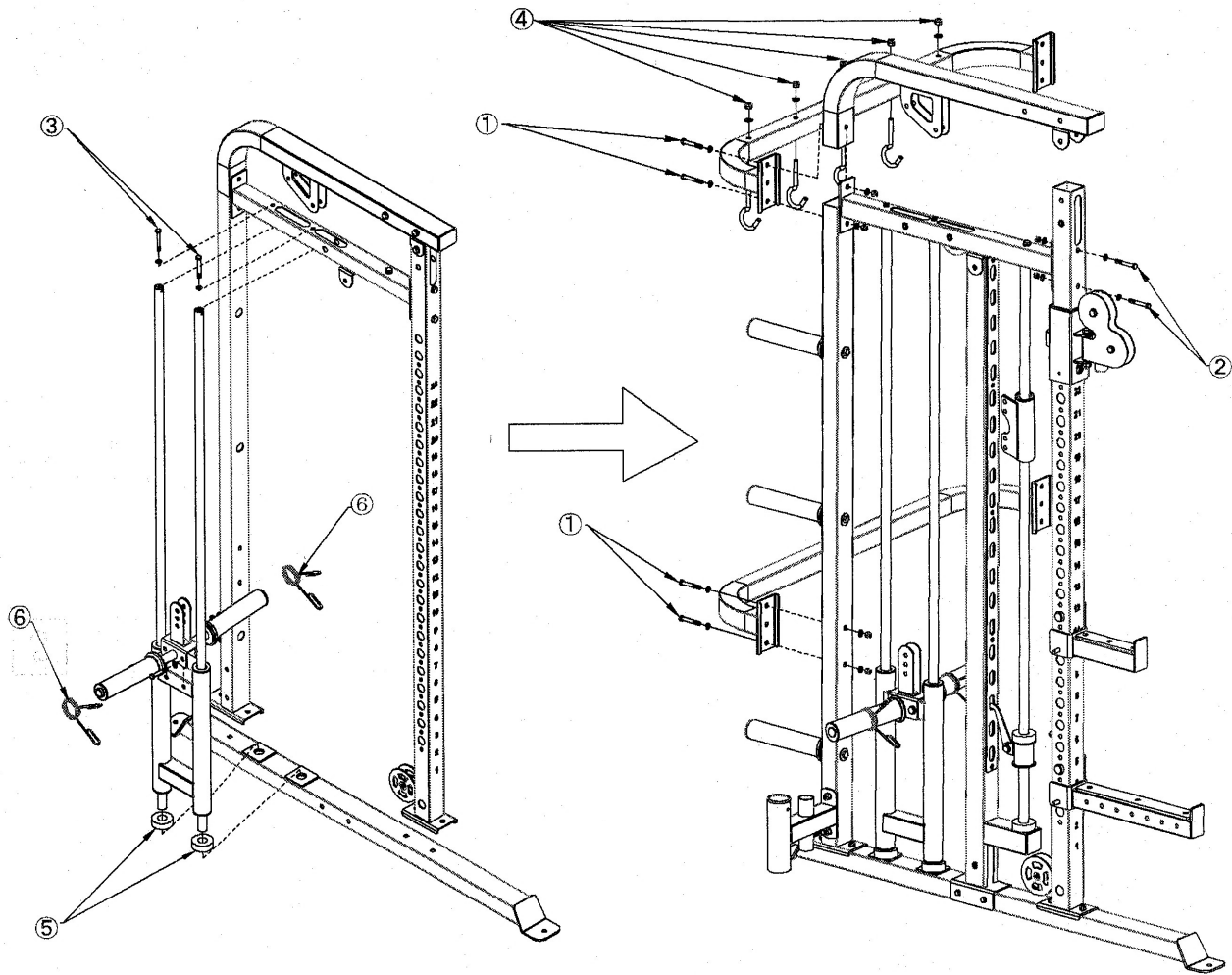

Serial No.:

5626

Installation Instruction

- ① M10 × 25 bolt, nut, washer x 8
- ② pinch-cock x 2

3

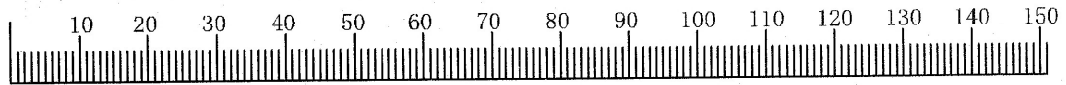
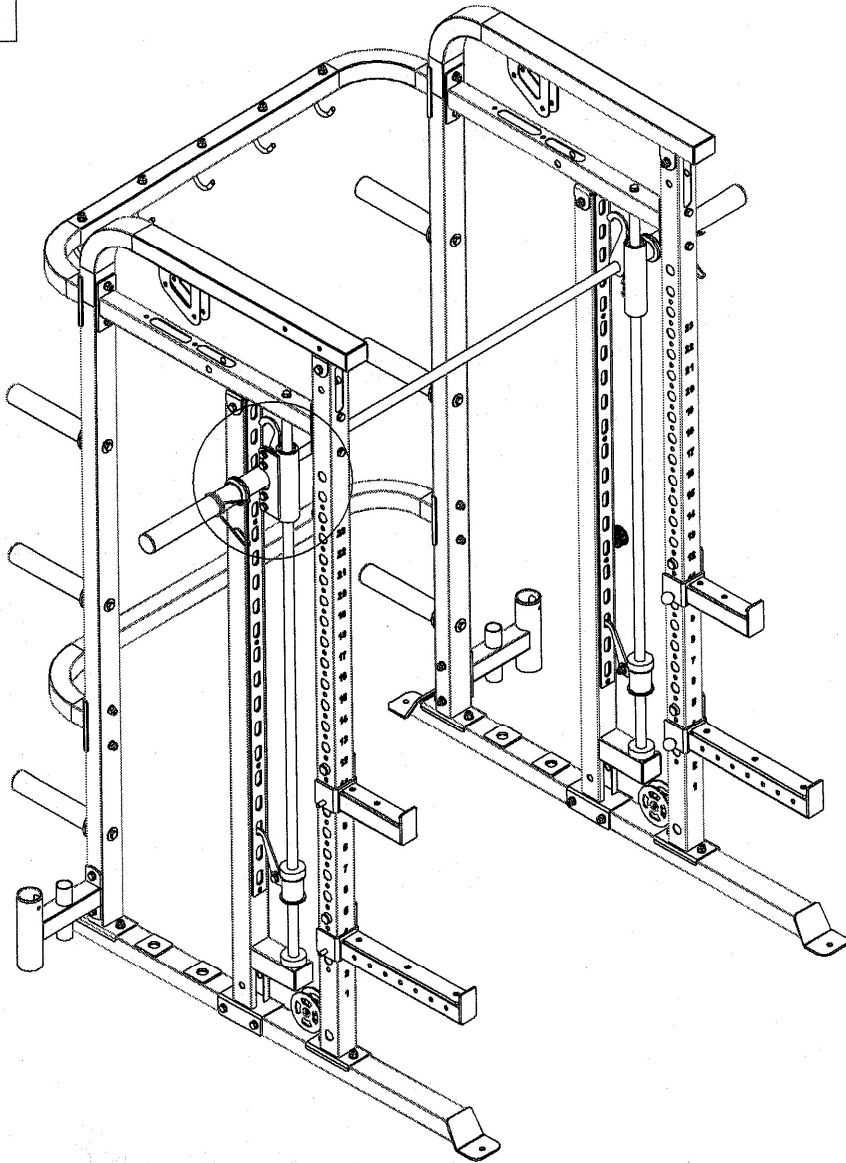

Millimeters

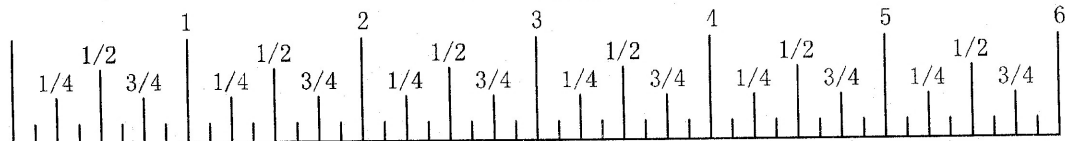

Inches

Serial No.:

5626

Installation Instruction

① M10 × 45 bolt, nut, washer x 12	② M10 × 70 bolt, nut, washer x 4	③ M10 × 80 bolt, nut, washer x 4	④ M10 × 90 bolt, nut, washer x 4
⑤ Aluminium pulley (φ 105) x 18	⑥ M8 Calabash hook x 4	⑦ drawstring x 2	

4 Cable x 2

