



Bropools

AWAKEN PLUNGE ICE BATH

USER MANUAL

Get ready to take the plunge and unlock a new level of wellbeing with the *Awaken Plunge Ice Bath*.

Treat the nervous, immune, and cardiovascular systems to some cold water therapy & unlock a new level of commitment, discipline and will power with this mindfulness challenge.



We are so excited for you to start your Bropools ice bath journey and experience all of the health benefits the *Awaken Plunge* has to offer.

Please read the user manual carefully before using, pay special attention to the safety precautions and keep for future reference.

Shenzhen Bropool Industrial Co., Ltd.

Call / WhatsApp : +86189 2844 8819

Email: simon@bropool.com

bropools   



CONTENTS

—

4

Bropools Wellness Promise

5

Safety Sheet

6

Installation Process

9

Maintenance

10

Failure Codes + Parameter Table

11

Troubleshooting Guide

12

Name Plate & Wiring Diagram

13

Warranty

Our Broopools Promise

ELEVATING YOUR WELLNESS & RECOVERY
THROUGH INNOVATIVE TECHNOLOGY



SET UP INSIDE
OR OUTDOORS

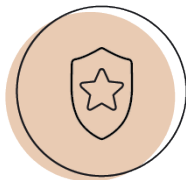

3 YEAR
WARRANTY

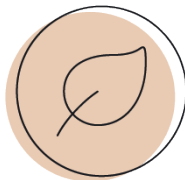

NON-TOXIC
MATERIALS

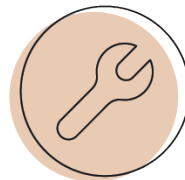

EASY TO
ASSEMBLE

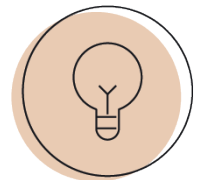

ENERGY
EFFICIENT

Safety Sheet

This ice bath can be used by children aged from 8 years and above, and persons with reduced physical, sensory or mental capabilities if they have been given supervision or instructions concerning use of the appliance in a safe way, and understand the hazards involved. Children should not be permitted to play with the ice bath. Cleaning and user maintenance should be conducted by adults only.

Do not place hands or any other object into the air outlet and fan, as it could damage the chiller and cause injuries. In the instance of any abnormality found in the chiller, please cut off the power and contact us immediately. It is strongly suggested to place a guard around the machine to keep children away from the chiller.

Installation Process

Before installing the chiller, check that your local power supply meets the requirements needed - a 15amp wall socket and a 20amp circuit breaker installed in the meter box. Fit the electrical protection devices in compliance with local regulations. For safety reasons, you should not replace or repair the chiller yourself. If the ice bath requires repairs, please contact us for assistance.

Do not place objects inside the chiller while it is working. They could come into contact with the fan and damage it, or cause an accident. Do not use the chiller without the grille or plaque, as this could cause the ice bath to malfunction. The ice bath may only be reset following a full inspection by a qualified service engineer. Unqualified service engineers may not adjust the ice baths switchboards, valves or controllers.

The ice bath can be set up in any location provided there's fresh air, electrical access and pool filter piping. Do not place the ice bath in an enclosed area with limited air volume where discharged air will be re-circulated. The ice bath should also not be set up in a location where the air inlet could be blocked. These locations deny the ice bath a continuous fresh air supply, which reduces its efficiency and may prevent adequate heat yield.



1 - Water pump switch

2 - Chiller switch

3 - Insulation cover

4 - Wooden bench

5 - Cold water bathtub

6 - Drain valve

In order for the ice bath to cool, the filter pump must be running so that the water can circulate through the chiller. Without this circulation, the chiller will not start. When all connections have been made and checked, the following steps should be followed:

1. Turn on the filter pump. Check for leaks.

2. Turn on the electrical power supply to the ice bath, then press the ON/OFF key on the electronic control panel. The ice bath should start when the time delay period has elapsed.

3. When the ice bath has been running for a couple of minutes, check if the air leaving the ice bath is hotter than the ambient temp.

4. Check the performance of the flow switch as follows: with the ice bath running turn the filter pump off. The ice bath should also switch off automatically.

5. The ice bath and the filter pump should run 24 hours a day until the desired pool water temperature has been reached. Once the set temperature is reached, the ice bath will switch itself off. As long as the filter pump is running, the ice bath will restart automatically when the temperature of the pool water raises more than 1 degree below the set temperature. Depending on the starting temperature of the water and the air temperature, it can take several days for the water to reach the desired temperature. Covering the pool can reduce this period.

User Instructions

The ice bath is easy to operate. Simply switch it on and set the desired water temperature. The system includes a computer controller, allowing all operation parameters to be easily set. Operation status can be displayed on the LED screen.

Icons

- The red indicator light will come on after switching on the power.
- The green indicator light will come on after the compressor starts.
- When the ice bath is switched off, the screen will display "OFF".
- When switched on, the screen will display the water temperature.
- If there is an operational issue, the ice bath will display an error code.



On/Off Button

Set

Set Button



Scroll/Temp Settings Button

Switch the on/off button to turn the ice bath on. Press set to check/designate a temperature. Increase or decrease the temperature using the scroll/temp settings button, then select set again to lock in your new temperature. Switch off via the on/off button.





Maintenance & Inspection

- Check the water inlet and drainage often. The water and air inflow into the system should be sufficient so that its performance and reliability does not get compromised. Clean the pool filter regularly to avoid damage to the ice bath caused by clogging of the filter.
- The area around the ice bath should be spacious and well ventilated. Clean the sides of the chiller regularly to maintain good heat exchange and to save energy.
- Check if all processes in the ice bath are operational and pay special attention to the operation pressure of the refrigerant system regularly.
- Check the power supply and cable connections regularly. Should the ice bath begin to function abnormally or should you notice a smell from an electrical component, contact us to arrange for an inspection, repair or replacement.
- We recommend that you purge the water if the ice bath will not work for an extended period of time. You should check all parts of the ice bath thoroughly and fill the system with water (to the top) before turning it on again to check the operation.

Failure Codes & Parameter Table

Control Display	Protection/Failure	Check	Solution
P1	Inlet water temp.sensor failure	1.Check the connection of inlet water sensor 2.Check if the sensor is broken	1.Reconnect the sensor 2.Replace the sensor
P2	Ambient temp.sensor failure	1.Check the connection of outlet water sensor. 2.Check if the sensor is broken	1.Reconnect the sensor 2.Replace the sensor
P3	Ambient temp.too low	1.Check if the sensor is broken 2.Check if the ambient temp.is less than10°C.	1.Replace the sensor 2.Stop use the heat pump
P4	Outlet water temp sensor failure	1.Check the connection of inlet water sensor 2.Check if the sensor is broken	1.Reconnect the sensor 2.Replace the sensor
P5	High pressure protection	1.Check if high pressure switch is broken. 2.Check if there is a blockage in water circuit or water flow is not enough. 3.Check if there is a blockage in refrigerant circuit	1.Replace high pressure switch. 2.Remove cause of blockage or increase water flow. 3.Send heat pump to dealer for detailed check.
P6	Outlet water overcool protection	1.Check if there is any jam in the water circuit. 2.Check if the water flow volume is enough. 3.Check if the water pump is working.	1.Remove the jam. 2.Increase the water flow volume. 3.Repair or replace the water pump.
E5	High pressure switch failure	1.Check the connection of pressure switch 2.Check if the switch is broken	1.reconnect the switch. 2.replace the switch.

Parameter	Control Display	Range	Default	Remark
A	Temp.Setting Cooling	3~28°C	7°C	Adjustable
B	Delta T for chiller re start	1~10°C	2°C	Adjustable
C	Ambient temp.too low setpoint	0~15°C	2°C	Adjustable
D	Delta T for too low ambient temp	1~15°C	2°C	Adjustable
E	Power loss memory	0/1	1(Yes)	Adjustable
F	Temp.calibration	-15~15°C	0°C	Adjustable
H	Too low outlet water temp.(protection)setting	0~10°C	2°C	Adjustable

Troubleshooting Guide

Incorrect installation may result in an electrical charge that could lead to serious injury to installers or others by electrical shock, and may also cause damage to the chiller. DO NOT attempt to modify the internal configuration of the chiller.

1. Keep your hands and hair clear of the fan blades to avoid injury.
2. If you are not familiar with your ice bath filtration system and chiller;
 - a. Do not attempt to carry out any adjustment or service without consulting us, a pool professional or an air conditioning contractor
 - b. Read the entire installation manual before attempting to use, service or make adjustments to the ice bath
 - c. Wait 24 hours after the installation before starting the chiller to prevent damage to the compressor. If the chiller has been transported and carried all the time with the feet down, it can be started immediately.

If a malfunction cannot be resolved immediately, in order to analyse the problem we will need to know the message (error code) that is showing on the display controller as well as the values for the settings. We also need to know the status of the chiller the ambient temperature, water inlet/outlet temperature, if there is cold air coming out from the chiller, if the grill (evaporator) is cold or if there is ice on the chiller. Please keep this information at hand when calling us to describe the issue.

Name Plate & Wiring Diagram

Unit Model	CT12/CT13/CT14
Rated Cooling Capacity	2KW
Input Power Cooling	1KW
Running Current Cooling	10.5
EER	2.0
Noise @1meter	110V/1PH/60Hz
Water Connection	56dB(A)
Water Flow Volune	G1"
GWP Value	0.7m ³ /h
Refrigerant(R410A)	300g
GWP Value	2088
T of CO ₂ equivalent	0.626

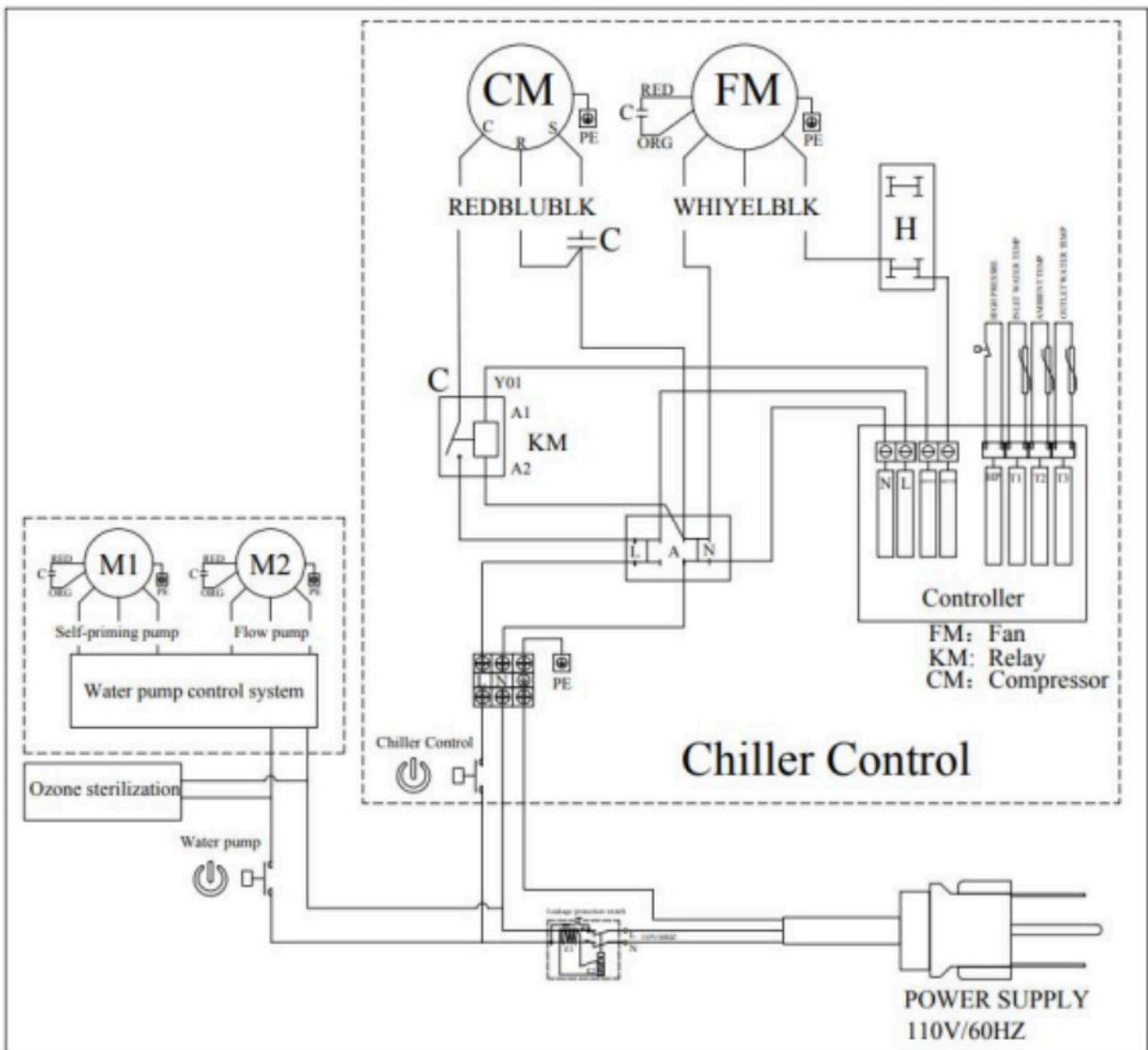

Warranty

Warranty Period: 3 year limited warranty on the shell parts. 1 year on electric parts.

Bropools are the warranty providers for Bropools products. Bropools warranty this product to be free from defects in materials and workmanship while in normal commercial use for a period of three years on parts and labour from the original date of purchase.

Do not return your ice bath to the store you purchased from before contacting Bropools directly.

LOGGING A WARRANTY CLAIM

Should you experience any issues with your product, please follow the below steps to lodge a warranty claim:

1. Contact Bropools and let them know the following details:

- Your warranty details including name, email and phone number
- Product name and model number
- Explanation of how the damage occurred
- Photos of the damage or issue is highly beneficial to expediting your claim

2. Bropools will assess your claim and respond within 24-48 hours. If the product exhibits a defect while in normal commercial use and within the warranty period; Bropools will either repair or replace the product or defective part free of charge.

3. In the event that the product is required to be sent to the service centre, the customer is required to pay for all packing, freight and insurance costs for transit of the product to Bropools. This is subject to the applicable consumer laws in your jurisdiction.

4. If the product, or one of its parts, qualifies for replacement or service within the 30-day period after the date of purchase, Bropools will arrange the shipping at no cost to you.

5. Any product sent to Bropools must include a return authorisation form that will be provided to you after your warranty claim is accepted. Failure to include this form may result in the product being rejected from the warehouse or a delayed service time.

6. In the event that the warranty period for a product has expired, or if a product does not qualify for warranty service, repair or replacement, customers can still buy replacement parts or have products repaired by one of the Bropools service centres. Please contact Bropools for further information. Bropools will contact you with a quote prior to undertaking any service work outside of the warranty coverage.

7. Typical turn-around times to address warranty claims can be between 10-14 business days, plus shipping, depending on location and type of damage or warranty claim.

8. In no event will the liability exceed the retail value of the product. We make no warranty with respect to parts, from a source other than Bropools warranty.

9. In the event that warranty parts or products are provided, the customer must cover the related shipping costs to receive goods.

10. All exchanged or substitute parts and products replaced under warranty service will become the property of Bropools. Repaired or replaced products or parts thereof will be warranted by Bropools for the balance of the original warranty period.

11. Bropools goods come with guarantees that cannot be excluded under the Australian Consumer Law. You are entitled to a replacement or refund for a major failure and compensation for any other reasonably foreseeable loss or damage. You are also entitled to have the goods repaired or replaced if the goods fail to be of acceptable quality and the failure does not amount to a major failure.

WARRANTY DOES NOT COVER

1. Damage, accidental or otherwise, to the product, not caused by a direct defect in factory workmanship or materials.

2. Damage due to abuse, mishandling, alteration, misuse, commercial service, tampering, accident, failure to follow the care, operating and handling provisions indicated in the instructions.

3. Damage caused by parts or services not authorised or performed by Bropools.

4. 'Normal' wear and tear that naturally and inevitably occurs as a result of normal use or ageing.

5. Some states do not allow the exclusion or limitation of incidental or consequential damages. Therefore, the above limitations may not apply to you in the case of damage in shipment. If your product was damaged in shipment: Immediately report this type of damage to the parcel carrier and have them file an inspection report to contact the distributor from whom you purchased the product for further instructions.

6. You have rights and benefits under the consumer laws in your jurisdiction. Without detracting from these rights or benefits, Bropools excludes all liability in respect of this product for any other loss which is not reasonably foreseeable from a failure of this product, which may include liability for negligence, loss of expenditure associated with the product and loss of enjoyment.

bro pools[®]

Shenzhen Bro pool Industrial Co., Ltd.

Call / WhatsApp : +86189 2844 8819

Email: simon@bro pool.com

bro pools   

Bropools products should not be considered medical devices, and should be treated as general wellness products only. Our product range has not been designed to prevent or treat medical conditions, and we recommend you consult a health practitioner if you are unsure about whether a Bropools product is suitable for you.