



# ATOMControl™

## Software Manual

Norsat ATOMControl™ version 2.1.9.13448 - Copyright 2013-2020 Norsat International Inc.

### CONFIGURATION

Communication Method:  COM Port  IP Address + Port

COM Port:

IP Address + Port:

Device Address:

### CONTROLS

Device Info | Device Config | Mute | RF | Custom Commands | FW Update

**Identification**

Serial Number:

Firmware Version:

Hardware Version:

Product Type:

**Status**

Fault Status:

Temperature:

RF Forward Power:

RF Reverse Power:

Unmute Time:

**Faults**

Over Temperature Fault

PLL Fault

Power Fault

Over Input Voltage Fault

PM1	PM2	Driver
-40°C	-40°C	-40°C

### LOG OUTPUT

The Communication Type has been set to Serial Port.  
 Setting the Serial Port Name...  
 The Serial Port Name has been set.  
 Initializing the BUC/SSPA Control Interface...  
 The BUC/SSPA Control Interface has been initialized.  
 The current Firmware Version is 1.2.0\_13436.  
 The current Hardware Version is RevA.  
 The device is a Ku GaN 80 W BUC with serial number 23322.

**NOTICE:** Norsat International Inc. ("Norsat") assumes no responsibility for errors or omissions that may appear in this publication. Norsat reserves the right to change this publication at any time, without notice.

**NORSAT ATOMControl™ – Software Manual. Copyright © 2014 - 2021.  
Norsat International Inc. All rights reserved.**

All materials contained in this user guide are the property of Norsat International Inc. except as noted here below:

All materials in this user guide are protected by United States and international copyright laws. The compilation of all content in this user guide is the exclusive property of Norsat International Inc.

## TABLE OF CONTENTS

Preface .....	5
Purpose and Scope of the User Guide .....	5
Audience .....	5
<b>1. ATOMControl Basics.....</b>	<b>7</b>
1.1 OVERVIEW.....	7
1.2 Launching ATOMControl .....	8
1.3 ATOMControl User Interface .....	9
1.4 Initializing Communication.....	9
1.5 Deinitializing Communication.....	10
1.6 Status Monitoring .....	11
<b>2. Monitoring Device Information.....</b>	<b>12</b>
2.1 Monitoring Device Information .....	12
<b>3. Controlling ATOM Devices .....</b>	<b>15</b>
3.1 Device Config Options.....	15
3.2 Controlling the Mute State .....	16
3.3 Attenuation Control.....	27
3.4 Sending Custom Commands.....	28
<b>4. Saving and Restoring Settings.....</b>	<b>31</b>
4.1 Saving Device Settings.....	31
4.2 Restoring Device Settings .....	32
<b>5. Firmware Update .....</b>	<b>35</b>
5.1 Firmware Update Capability .....	35
5.2 Backing Up System Settings .....	36
5.3 Firmware Image File.....	36
5.4 Performing Firmware Update.....	37
5.5 Reboot Device Function .....	43

## TABLE OF FIGURES

Figure 1: ATOMControl Start-Up Screen.....	8
Figure 2: ATOMControl Control Tabs.....	11
Figure 3: The Device Info Tab.....	12
Figure 4: Device Config Tab Controls .....	15
Figure 5: Mute Tab Controls.....	17
Figure 6: Standard Mute State Logic.....	18
Figure 7: Revised Mute State Logic .....	18
Figure 8: Hardware-Based Muting Controls .....	20
Figure 9: Fault-Based Muting Controls.....	24
Figure 10: Software-Based Muting Controls.....	25
Figure 11: Mute State.....	26
Figure 12: RF Tab Controls.....	27
Figure 13: The Custom Commands Tab .....	28
Figure 14: Command and Response Strings Showing <CR> and <LF>.....	30
Figure 15: Command and Response Strings Without <CR> and <LF> .....	30
Figure 16: Dump Flash Restore Commands to File Function .....	32
Figure 17: Restore Settings from File Function .....	33
Figure 18: Restore Settings File Selection Dialog .....	34
Figure 19: Firmware Update Tab Controls .....	36
Figure 20: Components of Current Firmware Version .....	37
Figure 21: FW Image Browse Function .....	38
Figure 22: Image File Selection Dialog.....	39
Figure 23: Image File Confirmation and Start Update Function .....	40
Figure 24: Progress Bar Indicates Firmware Update Progress.....	41
Figure 25: Confirmation of Updated Firmware Version.....	42
Figure 26: Reboot Device Button .....	43

## TABLE OF TABLES

Table 1: Product Type Values .....	13
Table 2: Detectable Faults .....	14
Table 3: Number of Power Modules for Each ATOM or Element Device Type .....	14
Table 4: Hardware-Based Muting.....	19
Table 5: Standard Fault-Based Muting.....	22
Table 6: Individual Fault-Based Muting .....	23
Table 7: Product Types Capable of Firmware Update .....	35

# Preface

## Purpose and Scope of the User Guide

The user guide explains the usage of the Norsat ATOMControl™ monitor and control application for ATOM and Element Series Block UpConverters (BUCs) and Solid-State Power Amplifiers (SSPAs).

This user guide is specifically written for the ATOMControl™ application. Additional information can be found in the ATOM Series BUC or SSPA User Manual.

## Audience

The guide will be of interest to the following personnel:

- Field users
- Systems administrators (or IT; Lifecycle/Sustainment Managers)

## **READ THE MANUAL BEFORE USING THE ATOMControl™ APPLICATION**

- CAUTION:** Do not stand in front of the waveguide during operation. In particular, do not look into the waveguide.
- CAUTION:** Do not allow any items to fall into the unit from the waveguide opening.
- CAUTION:** Always ensure that the waveguide is properly terminated during operation.
- CAUTION:** Apply voltage to the DC input connector only as specified in the original configuration of this unit. Application of a voltage outside of the specified range may cause the unit to become damaged or non-functional.
- WARNING:** DO NOT ALLOW EQUIPMENT TO BE IN STANDING WATER.  
While the BUC/SSPA is designed to be used outdoors, the equipment is not designed to operate in standing water. Failure to follow this precaution could result in electric shock and injury to persons.

# 1. ATOMControl Basics

---

**ATOMControl** is a program designed for monitoring and controlling Norsat's ATOM and Element Series of BUCs and SSPAs.

## 1.1 OVERVIEW

Norsat's ATOMControl software features an intuitive User Interface that provides the ability to monitor and control Norsat's ATOM and Element Series of Block Up-Converters and Solid-State Power Amplifiers. Basic device information can be monitored along with fault, temperature, and RF power data. ATOMControl also provides full control over an ATOM and Element Series device's mute state, and gives users the ability to monitor and set the value of a BUC's digital attenuator. Users may also communicate directly with the BUC or SSPA using a custom communication protocol.

ATOMControl is a stand-alone application that communicates with ATOM and Element Series BUCs and SSPAs using a serial RS-485 connection via a COM port on a host PC or laptop computer. Some ATOM BUC and SSPA models support a serial-over-Ethernet connection on a host PC or laptop computer.

ATOMControl is currently supported on Windows® 7 and 10.

## 1.2 Launching ATOMControl

ATOMControl should be launched like any other standard application: by double-clicking on the application's EXE file. ATOMControl does not require any Administrator-level privileges to run, and can thus be run by any user on the host PC.

At startup, ATOMControl will scan the host PC's available COM ports and will populate the **COM Port** drop-down list with the names of the COM ports that are discovered. The drop-down list can be repopulated at any time by pressing the **Re-Scan COM Ports** button. A connection option for Ethernet is available for ATOM and Element Series BUC and SSPA models that support a serial-over-Ethernet communication interface. ATOMControl will not attempt to communicate with the BUC or SSPA until the **Initialize** button is pressed.

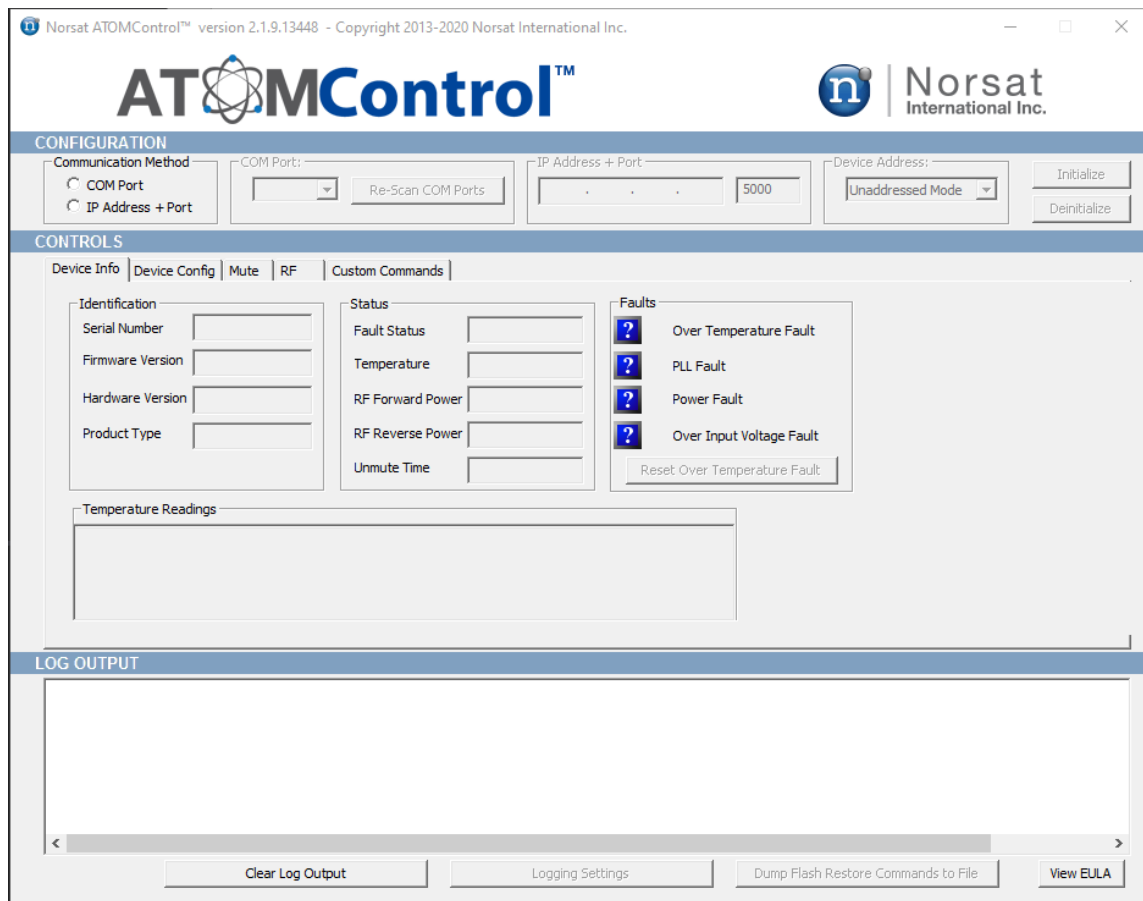

Figure 1: ATOMControl Start-Up Screen



## 1.3 ATOMControl User Interface

ATOMControl's User Interface is made up of three main sections: Configuration section, Controls section, and Log Output section. Additionally, the application's version number is displayed at the top of the application window in the title bar.

The *Configuration* section provides controls that let the user configure the communication settings that allow ATOMControl to communicate with an ATOM or Element BUC or SSPA. The user may select the COM port or specify the serial-over-Ethernet IP address and port that will be used for communication, repopulate the drop-down list of available COM ports, initialize the communication interface, and deinitialize the communication interface. (Not all BUC and SSPA models support both COM and Ethernet interfaces. Please check the user manual of the ATOM model for details.)

The *Controls* section provides controls that facilitate the monitoring and control of an ATOM or Element Series BUC or SSPA. A tabbed interface provides controls related to Device Information, Mute controls, Attenuation controls, and Custom Commands that can be sent to the BUC or SSPA.

The Log Output section contains a text field that will display messages related to ATOMControl operations performed on the ATOM or Element BUC or SSPA. Any errors encountered by the application will result in error messages being printed in this text field. Status information may also be printed in the text field. Text may be copied from this field so that it can be pasted into a text editor; the text field can also be cleared using the **Clear Log Output** button.

## 1.4 Initializing Communication

Communication with the ATOM or Element BUC or SSPA cannot be established unless the BUC or SSPA is physically connected to the Host PC (or laptop) running ATOMControl. Since most PCs and laptops lack an RS-485 serial port connection, it is recommended that a 4-Wire RS-485-to-RS-232 adapter be used to connect the ATOM device to the Host PC. A 4-Wire RS-485-to-USB adapter may also be used to facilitate the connection. Serial-over-Ethernet communication may be used for communicating with ATOM models that support a serial-over-Ethernet communication interface.

The Host PC's operating system should map the BUC or SSPA connection to a COM port that can be used by ATOMControl to communicate with the ATOM device for serial interface. ATOMControl will display the available COM ports in the **COM Port** drop-down list in the Configuration section of the User Interface. The list of available COM ports can be repopulated by pressing the **Re-Scan COM Ports** button. This allows the appropriate COM port to be selected even if the BUC or SSPA is connected to the Host PC after the ATOMControl application has been launched.

Once a COM port has been selected in the **COM Port** drop-down list or the device's serial-over-Ethernet IP address and port have been specified, communication with the BUC or SSPA can be established by pressing the **Initialize** button. ATOMControl will automatically detect the type of device it is communicating with (BUC or SSPA, plus the maximum output power of the device) and use this information to facilitate proper communication with the BUC or SSPA. The controls in the Controls section of the User Interface will also be enabled.

If communication cannot be established with the BUC or SSPA, an error message explaining the problem will be printed in the text field in the Log Output section of the User Interface. Successful communication will also be indicated in this text field. If communication with the BUC or SSPA is successfully established, the **COM Port** drop-down list, the **Re-Scan COM Ports** button, the **IP Address + Port** entry fields, and the **Initialize** button will be disabled and the **Deinitialize** button will be enabled.

## 1.5 Deinitializing Communication

Deinitializing the ATOMControl communication interface halts all communication with the BUC or SSPA, and allows the settings in the Configuration section of the User Interface to be changed. The communication interface can be deinitialized by pressing the **Deinitialize** button in the Configuration section of the User Interface. If the communication interface is successfully deinitialized, the **COM Port** drop-down list, the **Re-Scan COM Ports** button, the **IP Address + Port** entry fields, and the **Initialize** button will be enabled and the **Deinitialize** button will be disabled. A status message will also be printed in the text field in the Log Output section of the User Interface. If the communication interface could not be deinitialized, an error message will be printed in the text field in the Log Output section of the User Interface.

ATOMControl has been configured to automatically deinitialize the communication interface when the application is closed.

## 1.6 Status Monitoring

Once the ATOMControl communication interface has been successfully initialized and is connected to an ATOM or Element device, status monitoring will begin automatically on the currently selected control tab. Monitoring is only enabled for the selected control tab and is disabled for all other control tabs. All monitoring is disabled when communication is deinitialized.

**Figure 2** below shows the ATOMControl control tabs:

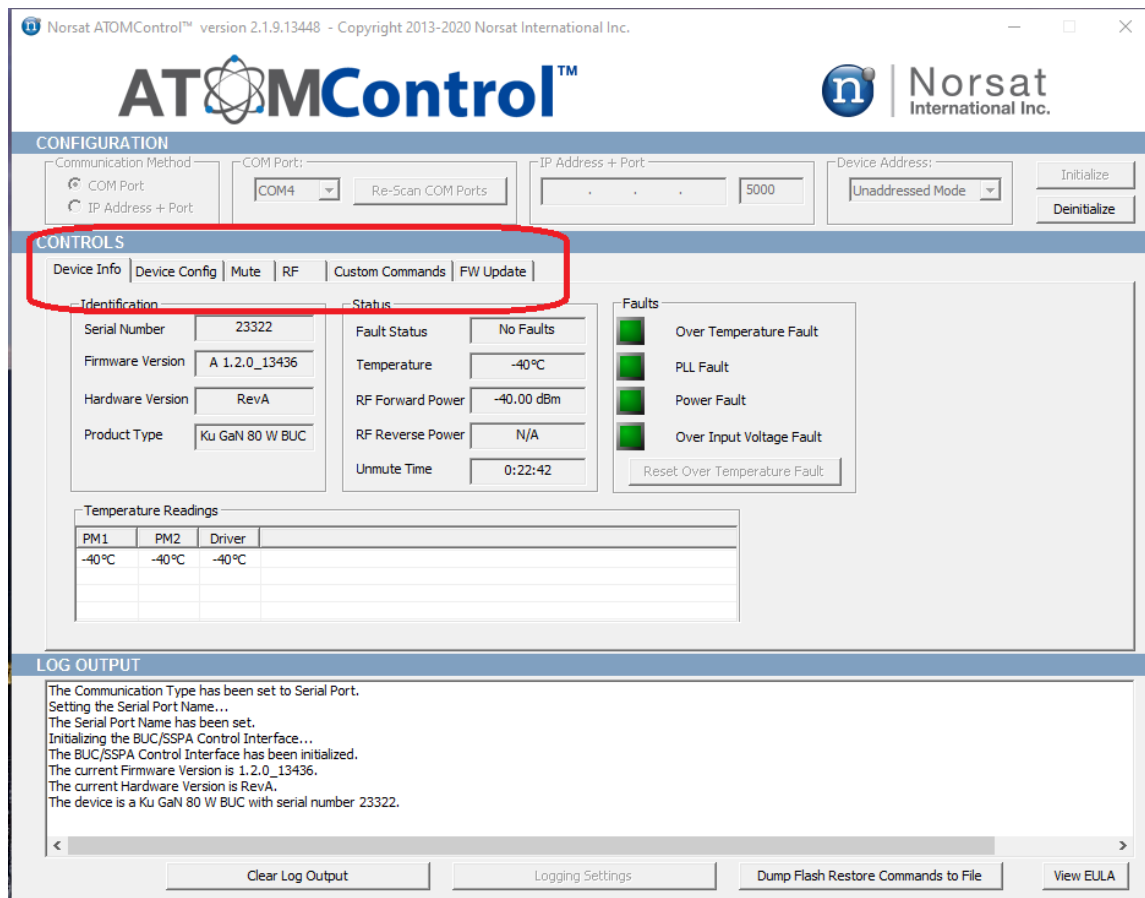

**Figure 2: ATOMControl Control Tabs**

## 2. Monitoring Device Information

This chapter explains how to use ATOMControl to monitor identification, status, fault, and temperature data for an ATOM Series BUC or SSPA, and Element Series BUC.

### 2.1 Monitoring Device Information

The tabbed interface in the Controls section of the ATOMControl User Interface contains five monitoring tabs: the Device Info tab, the Device Config tab, the Mute tab, the RF tab, and the Custom Commands tab. For a device that supports firmware update, the FW Update tab also appears. The Device Info tab can be used to monitor basic information for the BUC or SSPA.

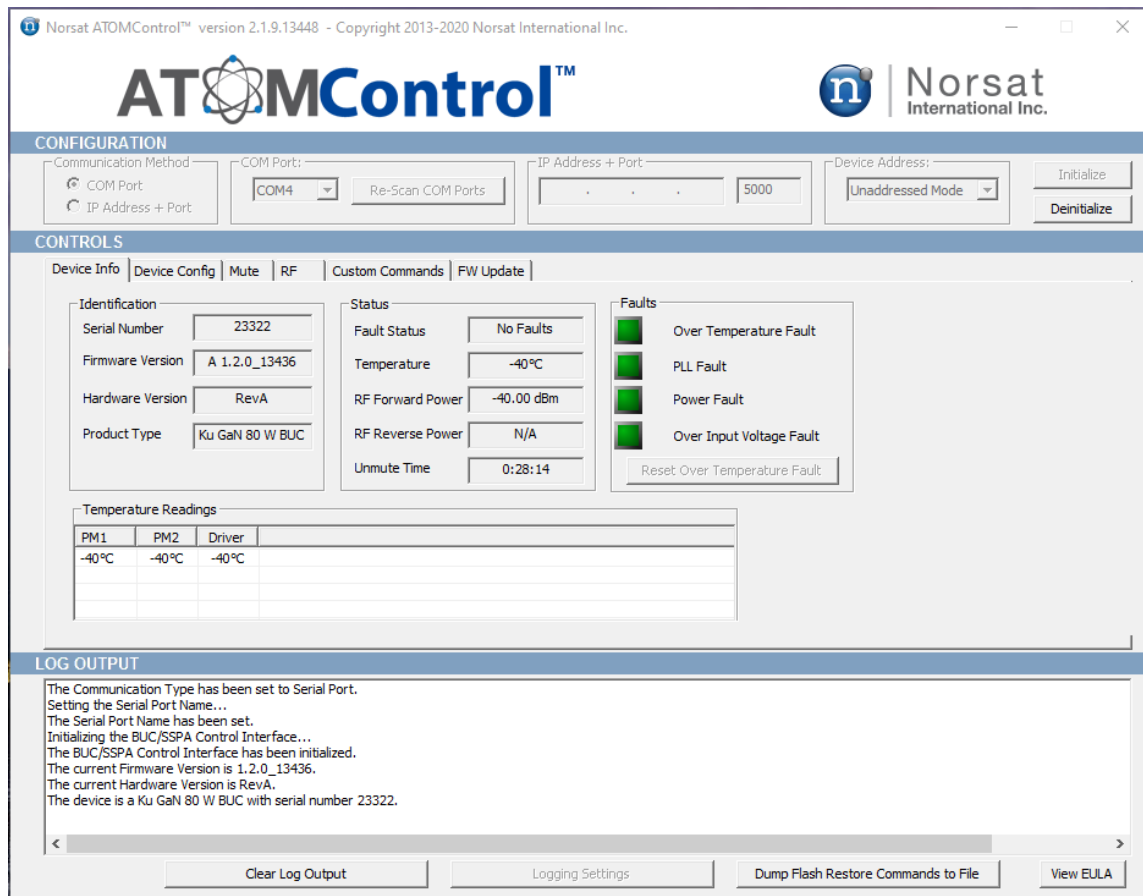

Figure 3: The Device Info Tab

If the Device Info tab is selected, device information monitoring will begin automatically when the ATOMControl communication interface is successfully initialized. Monitoring is automatically disabled when switching to a different tab, and is automatically enabled when switching back to the Device Info tab. Deinitializing the communication interface while the Device Info tab is selected will also disable device information monitoring.

The Device Info tab contains five sets of data: Identification data, Status data, Faults data, Synthesizer data, and Temperature Readings data. Data for each set will be populated automatically and continuously updated while the Device Info tab remains selected.

The *Identification* data set contains information that can be used to identify a BUC or SSPA. The **Serial Number** field will list the unique serial number for the device. The **Firmware Version** field provides the four-part version number for the firmware running on the ATOM device's internal processor. The **Product Type** field indicates the maximum output power and the device type; possible values are provided in **Table 1** below.

BUC Product Types	SSPA Product Types
Ku 25 W BUC	Ku 25 W SSPA
Ku 40 W BUC	Ku 40 W SSPA
Ku 50 W BUC	Ku 50 W SSPA
Ku 100 W BUC	Ku 100 W SSPA
Ku 250 W BUC	Ku 250 W SSPA
Ku GaN 20 W BUC	Ku GaN 20 W SSPA
Ku GaN 40 W BUC	Ku GaN 40 W SSPA
Ku GaN 80 W BUC	Ku GaN 80 W SSPA
Ka 25 W BUC	Ka 25 W SSPA
Ka 50 W BUC	Ka 50 W SSPA
Ka 12 W BUC (Element Series)	---

**Table 1: Product Type Values**

The *Status* data set contains basic status information for the BUC or SSPA. The **Fault Status** field indicates whether any fault has been detected on the device; detailed fault information is available in the *Faults* data set described below. The **Temperature** field indicates the system temperature for the device. This is the temperature of Power Module 1 for Ku GaN devices, Power Module 8 for Ku GaAs 100 W BUCs and SSPAs, or Power Module 2 for all other ATOM devices. The **RF Forward Power** field shows the current output power for the device in dBm.

Detailed fault information is provided in the *Faults* data set. A LED icon is shown for each of the faults that can be detected for a device. If the LED icon shows red, then the corresponding fault has been detected; otherwise, the LED icon shows green for no fault has been detected, or blue question mark when a fault is N/A for a device.

**Table 2** below shows the detectable faults and their cause:

Fault	Cause
Over Temperature	The system temperature exceeds the Over Temperature Fault Trip Point temperature (90 ° C by default)
Power	The Voltage Monitor has detected that one of the input voltages is too low
PLL	At least one Phase Lock Loop (PLL) Lock has been lost
Over Input Voltage	The input voltage is too high

**Table 2: Detectable Faults**

Note that the Power Fault only applies to Ku GaN BUCs and SSPAs, and to Ku GaAs 100 W BUCs and SSPAs. The indicator for the Power fault is hidden for all other ATOM and Element devices.

Also note that the Over Input Voltage Fault only applies to Ku GaN BUCs and SSPAs. The indicator for the Over Input Voltage Fault is shown as N/A for all other ATOM and Element devices.

Further note that the PLL Fault only applies to BUCs. The indicator for the PLL fault will always show N/A for SSPAs.

The *Temperature Readings* data set shows the current temperature for each of the Power Modules contained within the ATOM device in addition to the current temperature of the device's Driver Module. Measured temperatures range from -40°C to 125°C.

**Table 3** below shows the number of Power Modules for each type of ATOM device:

Device Type	Number of Power Modules
Ku GaN 25 W BUC or SSPA	1 + 1 Driver Module
Ku GaN 40 W BUC or SSPA	1 + 1 Driver Module
Ku GaN 80 W BUC or SSPA	2 + 1 Driver Module
Ku 25 W BUC or SSPA	2 + 1 Driver Module
Ku 40 W BUC or SSPA	4 + 1 Driver Module
Ku 50 W BUC or SSPA	4 + 1 Driver Module
Ku 100 W BUC or SSPA	9 + 1 Driver Module
Ka 25 W BUC or SSPA	5 + 1 Driver Module
Ka 50 W BUC or SSPA	10 + 1 Driver Module
Ka 12 W BUC (Element Series)	2 Power Modules

**Table 3: Number of Power Modules for Each ATOM or Element Device Type**

## 3. Controlling ATOM Devices

This chapter explains how to use ATOMControl to configure the Device Config options for an ATOM or Element BUC, how to configure the Mute State of an ATOM or Element BUC or SSPA, how to configure the Digital Attenuator for an ATOM or Element BUC, and how to send custom commands to any ATOM or Element device.

### 3.1 Device Config Options

The Device Config tab can be used to select the output signal configuration and the PLL reference for an ATOM or Element Ka BUC. Only a Ka BUC has these synthesizer options.

This tab is made up of two sections: The *Output Signal Configuration* section and the *PLL Reference* section.

Figure 4 below shows the Device Config tab controls:

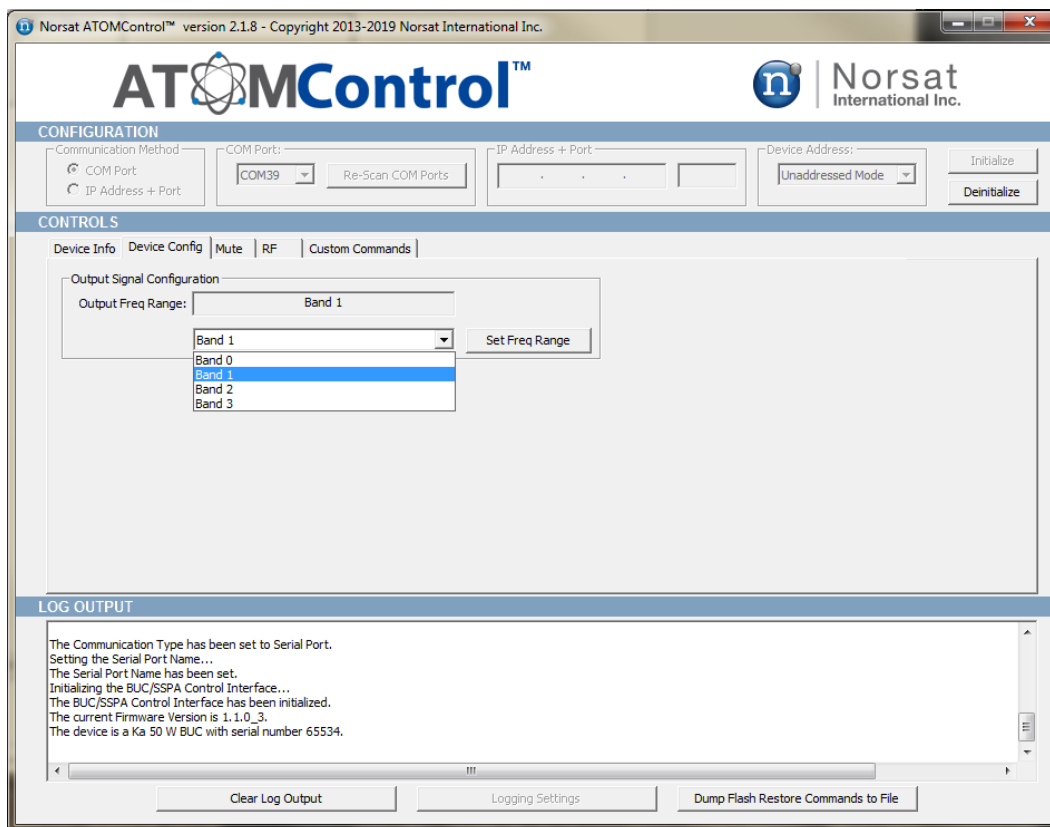

Figure 4: Device Config Tab Controls

The *Output Signal Configuration* section displays the current transmit band setting (i.e. Output Frequency Range and LO Frequency) and provides options for selecting another band. An ATOM or Element Ka BUC supports up to four operational bands labeled Band 0, Band 1, Band 2 and Band 3. The output frequency range of each band depends on the customized synthesizer hardware in the BUC. Please refer to the ATOM or Element Ka BUC User Manual for the output frequency range and LO frequency for each available band. To set a band, select one of the four bands and then click on the **Set Freq Range** button.

The *PLL Reference* section contains two radio buttons that can be used to configure the PLL reference method used by the Ka BUC. Click on the desired radio button to select between the two options.

The two options are:

- **Auto Int / Ext 10 MHz Reference:**

Operates in auto-detect mode based on the RF input signal. When an external 10 MHz reference signal is not detected from the RF input signal, the internal 10 MHz reference of the BUC will be used instead.

- **External 10 MHz Reference:**

Specifies that the RF input carries a 10 MHz reference signal and will be used as reference. If no 10 MHz reference signal is detected in the RF input signal, a PLL Fault will be generated for the BUC.

## 3.2 Controlling the Mute State

The Mute tab can be used to monitor and control the mute configuration for the BUC or SSPA.

If the Mute tab is selected, then Mute Configuration monitoring will begin automatically when the ATOMControl communication interface is successfully initialized. Monitoring is automatically disabled when switching to a different tab, and is automatically re-enabled when switching back to the Mute tab. Deinitializing the communication interface while the Mute tab is selected will also disable Mute Configuration monitoring.



Figure 5 below shows the Mute tab controls:

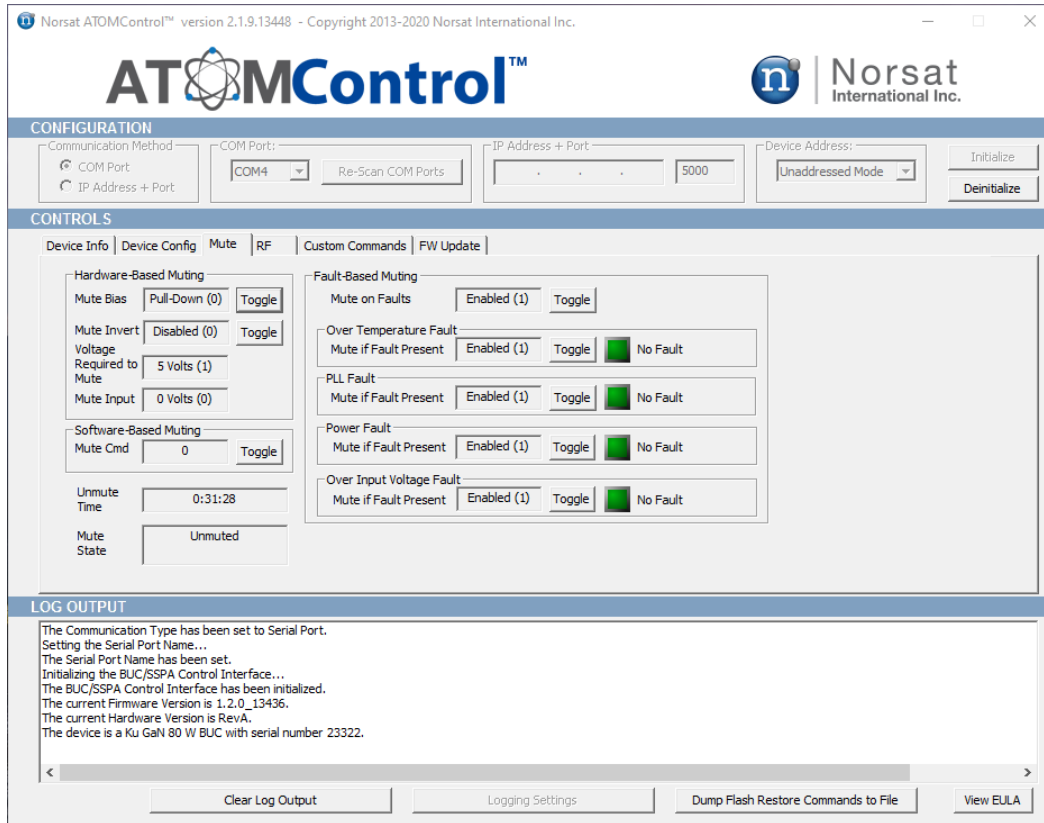

Figure 5: Mute Tab Controls

A device's Mute State is controlled by one hardware input signal, four user-controllable software parameters, and up to four fault indicators. ATOMControl monitors the values of all of these and displays them in the Mute Tab of the User Interface.

The signals are:

- Mute Input: The hardware input line corresponding to pin D of the MIL-C-26482 control interface
- Mute Invert: Determines which value of the Mute Input line represents Mute and which value represents Unmute
- Mute Bias: Determines the value of the Mute Input line if the hardware input is left floating
- Mute Command: Software mute setting
- Mute on Faults: Indicates whether the device will be muted if a fault is detected

Muting can thus be caused by up to four potential sources depending on ATOM or Element model: a hardware-based mute triggered through the Mute Input hardware signal, fault-based muting triggered by one to four faults, and software-based muting triggered using the Mute Command parameter. Software-based muting will override both fault-based muting and hardware-based muting. Fault-based muting will also override hardware-based muting.

The hardware signal, four software parameters, and up to four faults interact with each other to produce the overall Mute State in one of two ways. While most devices will use the Standard Mute Logic shown in **Figure 6**, some Ku GaAs 100 W devices (running firmware version 1.1.0\_1 or higher) and all Ku GaN devices will use the Revised Mute Logic shown in **Figure 7**.

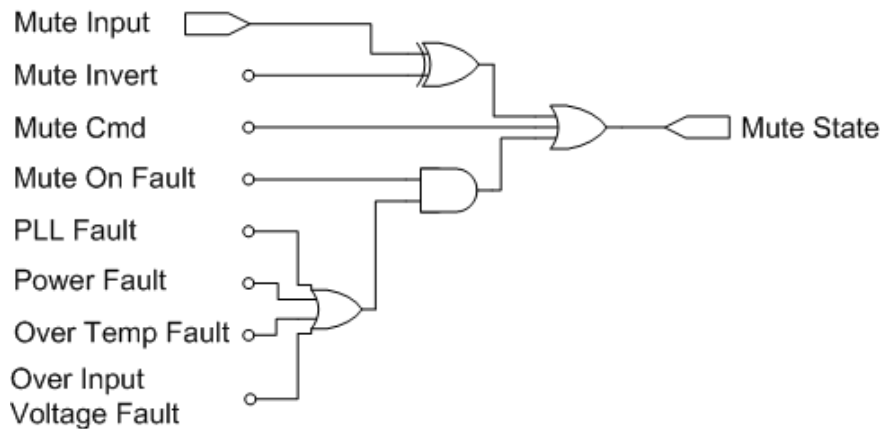

**Figure 6: Standard Mute State Logic**

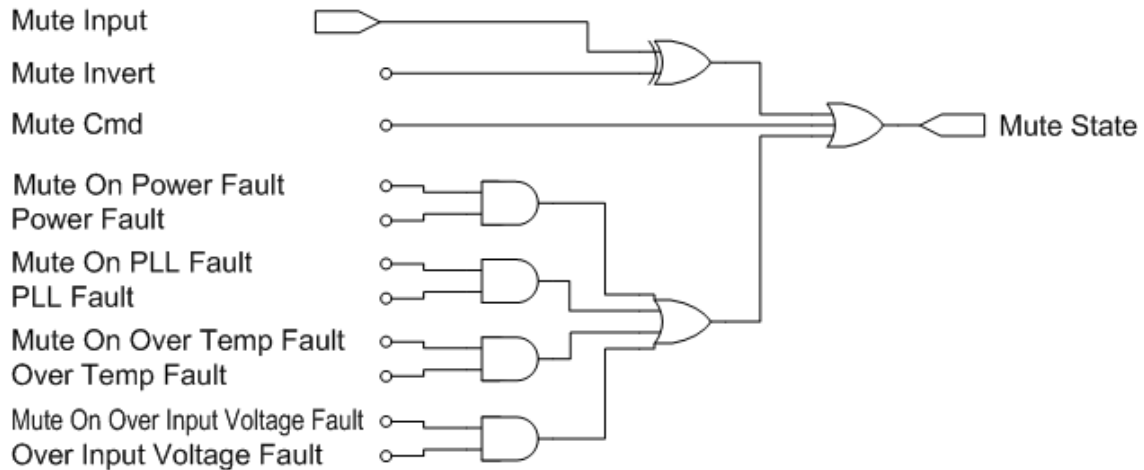

**Figure 7: Revised Mute State Logic**

### 3.2.1 Hardware-Based Muting

Hardware-based muting is controlled by three values: The Mute Input hardware line, the Mute Invert software parameter, and the Mute Bias software parameter. The Mute Input line allows external devices to control whether the BUC or SSPA is muted or unmuted. The signal value required to mute or unmute the device is determined by the value of the Mute Invert parameter. If Mute Invert is 0, then setting Mute Input to 0 V will unmute the device and setting Mute Input to 5 V will mute the device. If Mute Invert is 1, then setting Mute Input to 0 V will mute the device and setting Mute Input to 5 V will unmute the device.

The Mute Bias signal controls the value of the Mute Input hardware line if the hardware line is left floating. If Mute Bias is 0, then a floating Mute Input line will be pulled down to 0 V. If Mute Bias is 1, then a floating Mute Input line will be pulled up to 5 V.

Note that in the above logic diagrams, the **Mute Input** signal is assumed to already take the Mute Bias into account.

By default, both Mute Bias and Mute Invert are set to 0.

The hardware-based muting parameter interactions are summarized in Table 4 below:

Mute Input Voltage	Mute Input Logical Value	Mute Invert Logical Value	Mute Bias Logical Value	Hardware Mute Result
0 V	0	0	0	Unmuted
0 V	0	0	1	Unmuted
0 V	0	1	0	Muted
0 V	0	1	1	Muted
5 V	1	0	0	Muted
5 V	1	0	1	Muted
5 V	1	1	0	Unmuted
5 V	1	1	1	Unmuted
Floating	Z	0	0	Unmuted
Floating	Z	0	1	Muted
Floating	Z	1	0	Muted
Floating	Z	1	1	Unmuted

**Table 4: Hardware-Based Muting**

ATOMControl shows all of the values relevant to hardware-based muting in the top-left groupbox in the Mute tab in the Controls section of the User Interface. The logical value of the Mute Input line, the Mute Invert parameter, and the Mute Bias parameter are all displayed along with buttons that allow the Mute Invert and Mute Bias signal values to be toggled between 0 and 1. **Figure 8** below shows the hardware-based muting controls:

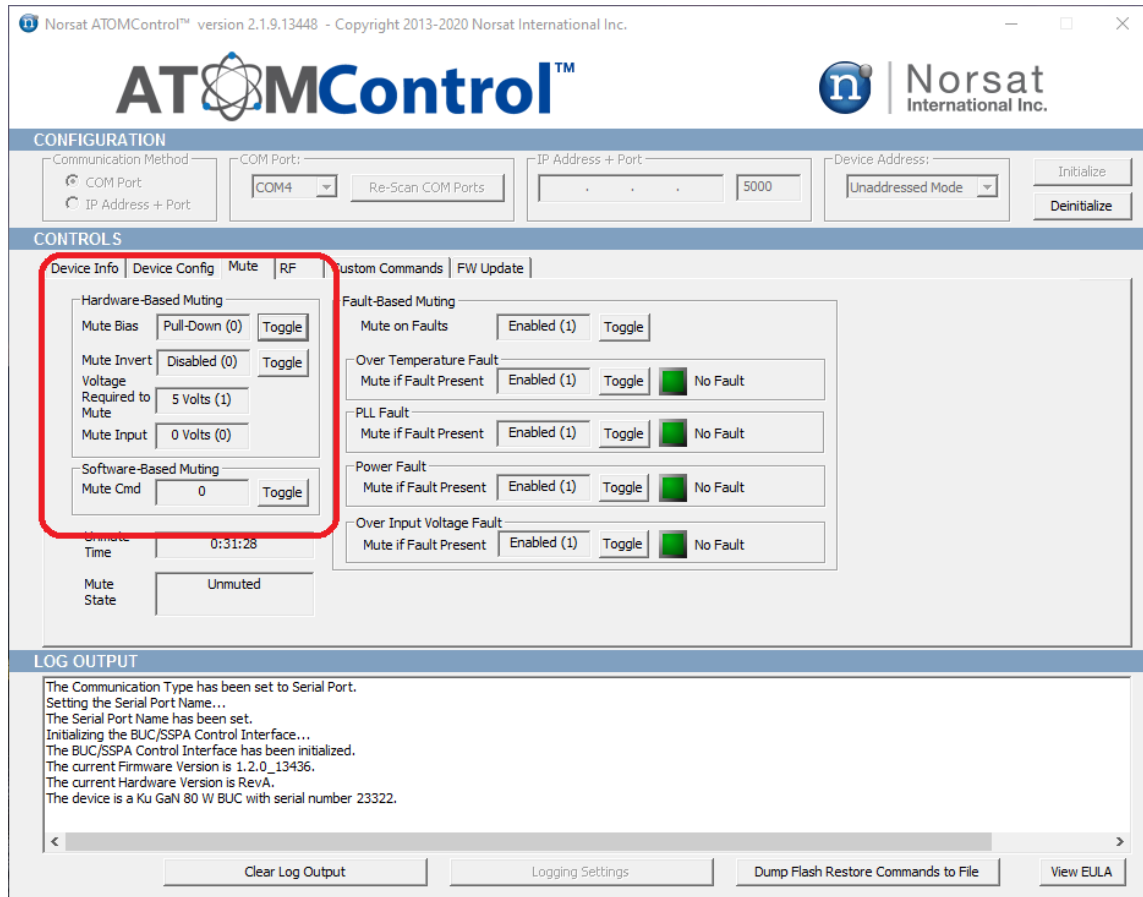

**Figure 8: Hardware-Based Muting Controls**

The value represented in the Mute Input field depends on the type of device that ATOMControl is monitoring. If the device is a Ku GaAs 100 W or 250 W BUC or SSPA, then the Mute Input fields will show the overall mute state, with 0 indicating that the device is unmuted and 1 indicating that the device is muted. For all other devices, the Mute Input field will display the value of the Mute Input hardware line. A value of 0 represents 0 V, and a value of 1 represents 5 V.

### 3.2.2 Fault-Based Muting

Fault-based muting automatically mutes the device if one or more faults are detected on the BUC or SSPA. A PLL Fault, a Power Fault, an Over Temperature Fault, and an Over Input Voltage Fault can all trigger automatic muting (some faults are not available on some models). These faults will mute the device if the appropriate Mute on Fault software parameter is set to 1, and the fault is detected on the device. If the appropriate Mute on Fault parameter is set to 0 then the device will not automatically mute if the fault is detected on the device. By default, all Mute on Fault parameters are set to 1.

Most devices use a single parameter (labelled **Mute on Faults**) to control the muting behavior for the four detectable faults. Some Ku GaAs 100 W devices (running firmware version 1.1.0.1 or higher) and all Ku GaN devices have the ability to configure the mute behavior for each of the applicable faults individually. ATOMControl will automatically detect whether the connected device can use the individual settings and will enable or disable the individual Mute on Fault controls appropriately.

Note that if the device does support the individual Mute on Fault controls, the **Mute on Faults** parameter will be set to 1 if any of the individual Mute on Fault settings are set to 1.

Table 5 below shows the interaction of the standard fault-based muting parameters:

Mute on Faults	Power Fault *	OverTemp Fault	PLL Fault **	Over Input Voltage Fault ***	Fault Mute Result
0	0	0	0	0	Unmuted
0	0	0	0	1	Unmuted
0	0	0	1	0	Unmuted
0	0	1	0	0	Unmuted
0	1	0	0	0	Unmuted
0	1	1	0	0	Unmuted
0	0	1	1	0	Unmuted
0	0	0	1	1	Unmuted
0	1	0	1	0	Unmuted
0	1	0	0	1	Unmuted
0	0	1	0	1	Unmuted
0	1	1	1	0	Unmuted
0	0	1	1	1	Unmuted
0	1	1	0	1	Unmuted
0	1	1	1	1	Unmuted
1	0	0	0	0	Unmuted
1	0	0	0	1	Muted
1	0	0	1	0	Muted
1	0	1	0	0	Muted
1	1	0	0	0	Muted
1	1	1	0	0	Muted
1	0	1	1	0	Muted
1	0	0	1	1	Muted
1	1	0	1	0	Muted
1	1	0	0	1	Muted
1	0	1	0	1	Muted
1	1	1	1	0	Muted
1	0	1	1	1	Muted
1	1	1	0	1	Muted
1	1	0	1	1	Muted
1	1	1	1	1	Muted

**Table 5: Standard Fault-Based Muting**

**Table 6** below shows the interaction of the individual fault-based muting parameters:

Mute on Power Fault *	Mute on PLL Fault **	Mute on Over Input Voltage Fault ***	Mute on OverTemp Fault	Power Fault *	PLL Fault **	Over Input Voltage Fault ***	OverTemp Fault	Fault Mute Result
0	0	0	0	0	0	0	0	Unmuted
0	0	0	0	1	0	0	0	Unmuted
1	0	0	0	0	0	0	0	Unmuted
1	0	0	0	1	0	0	0	Muted
0	0	0	0	0	0	0	0	Unmuted
0	0	0	0	0	1	0	0	Unmuted
0	1	0	0	0	0	0	0	Unmuted
0	1	0	0	0	1	0	0	Muted
0	0	0	0	0	0	0	0	Unmuted
0	0	0	0	0	0	1	0	Unmuted
0	0	1	0	0	0	0	0	Unmuted
0	0	1	0	0	0	1	0	Muted
0	0	0	0	0	0	0	0	Unmuted
0	0	0	0	0	0	0	1	Unmuted
0	0	0	1	0	0	0	0	Unmuted
0	0	0	1	0	0	0	1	Muted

**Table 6: Individual Fault-Based Muting**

- \* Power Fault is only available on 100 W or higher power ATOM devices
- \*\* PLL Fault is only available on BUC models
- \*\*\* Over Input Voltage Fault is only available on G models

ATOMControl shows all of the values relevant to Fault-Based Muting in the top-right groupbox in the Mute tab in the Controls section of the User Interface. The value of the Mute on Faults parameter is displayed along with a button that allows the Mute on Faults value to be toggled between 0 and 1.

Controls are also provided for each of the individual Mute on Fault parameters (Mute on Power Fault, Mute on PLL Fault, Mute on Over Temperature Fault, Mute on Over Input Voltage Fault) though the controls are automatically disabled if the device does not support the individual parameters.

The Fault-Based Muting groupbox additionally contains up to four read-only checkboxes that indicate whether each of the mute-inducing faults has been detected.

**Figure 9** below shows the hardware-based muting controls:

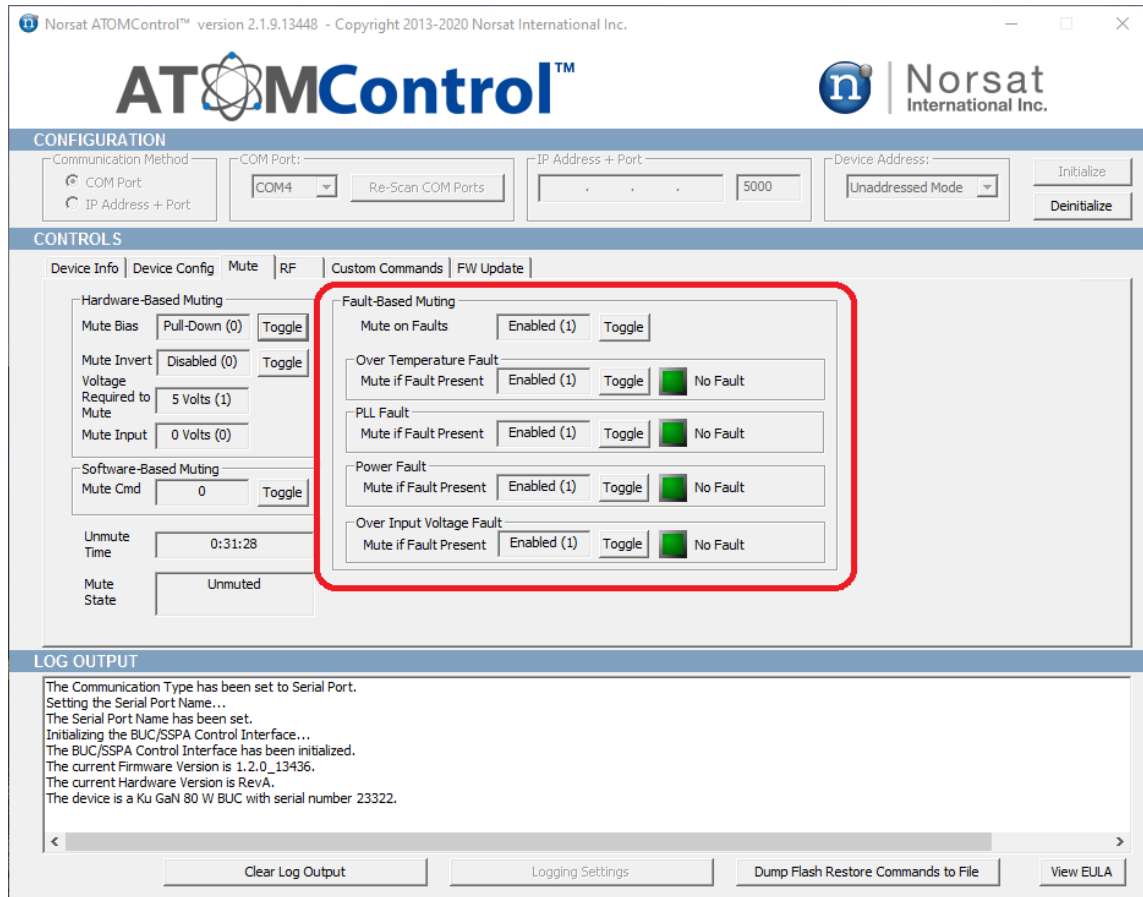

Figure 9: Fault-Based Muting Controls



### 3.2.3 Software-Based Muting

Software-based muting is controlled by a single parameter that overrides all other muting controls: the Mute Command parameter. If Mute Command is set to 1 then the device will be muted. If the Mute Command signal is set to 0 then the device will be unmuted (assuming it is not muted by hardware or by faults). By default, the Mute Command parameter is set to 0.

ATOMControl shows all of the values relevant to software-based muting in the bottom-left groupbox of the Mute tab under the Controls section of the User Interface. The value of the Mute Command parameter is displayed along with a button that allows the Mute Command value to be toggled between 0 and 1.

**Figure 10** below shows the software-based muting controls:

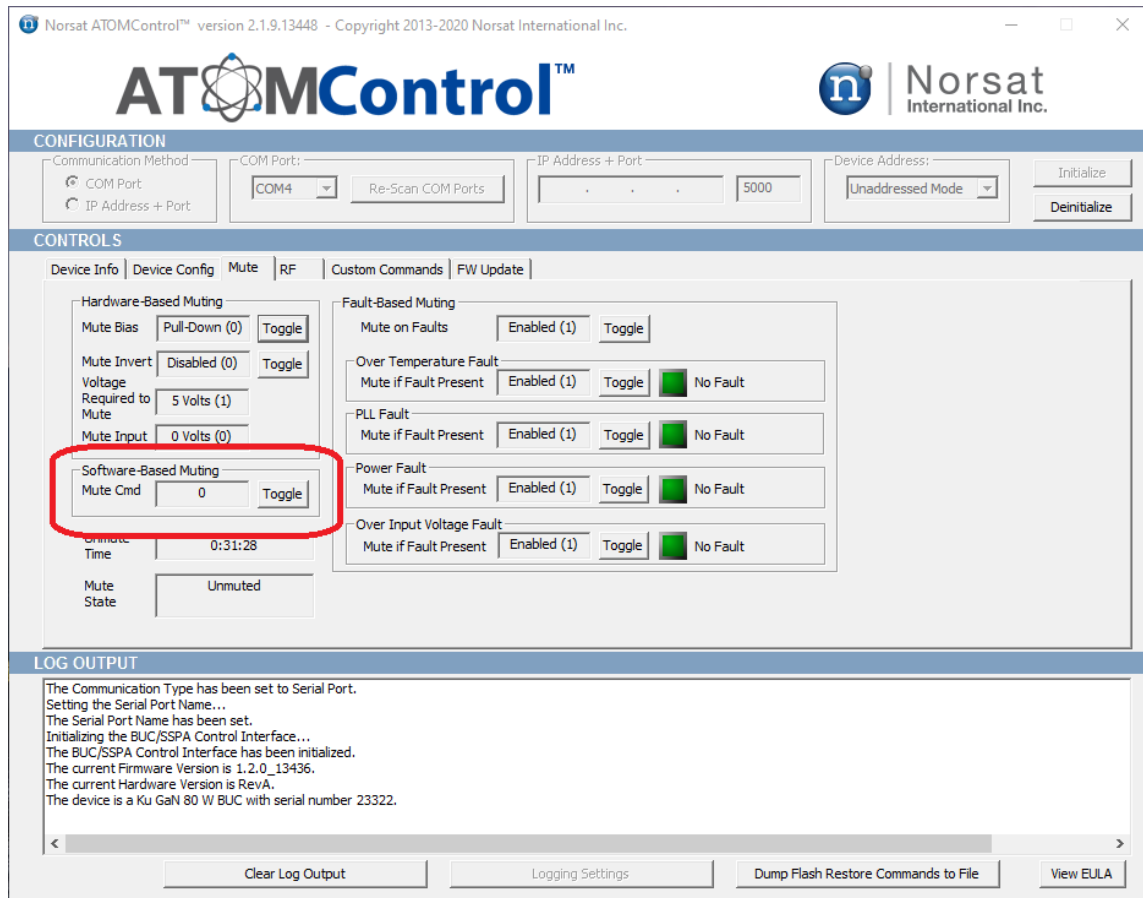

**Figure 10: Software-Based Muting Controls**

### 3.2.4 Unmuting the Device

ATOM and Element Series devices are unmuted only if nothing is causing them to be muted. The parameters for hardware-based muting, fault-based muting, and software-based muting must **all** be in a state that does not cause the BUC or SSPA to be muted in order for the device to be in an unmuted state. ATOMControl displays the overall Mute State in the Mute tab under the Controls section of the User Interface as shown in **Figure 11** below:

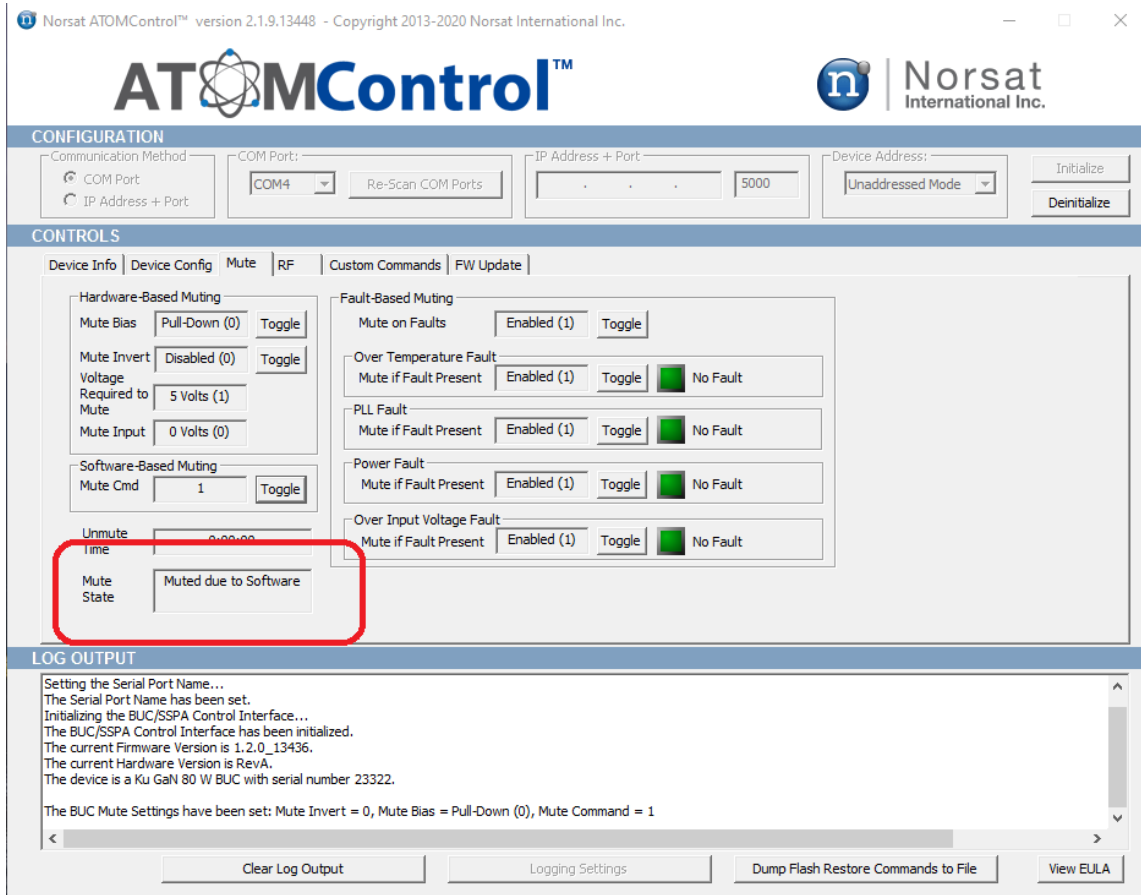

**Figure 11: Mute State**

### 3.3 Attenuation Control

The RF tab can be used to monitor and control the Digital Attenuator for an ATOM or Element BUC.

Note that only BUCs have a Digital Attenuator; the attenuation controls are disabled for SSPAs.

If the RF tab is selected, then attenuation monitoring will begin automatically when the ATOMControl communication interface is successfully initialized. Monitoring is automatically disabled when switching to a different tab, and is automatically re-enabled when switching back to the RF tab. Deinitializing the communication interface while the RF tab is selected will also disable attenuation monitoring.

Figure 12 below shows the RF tab controls:

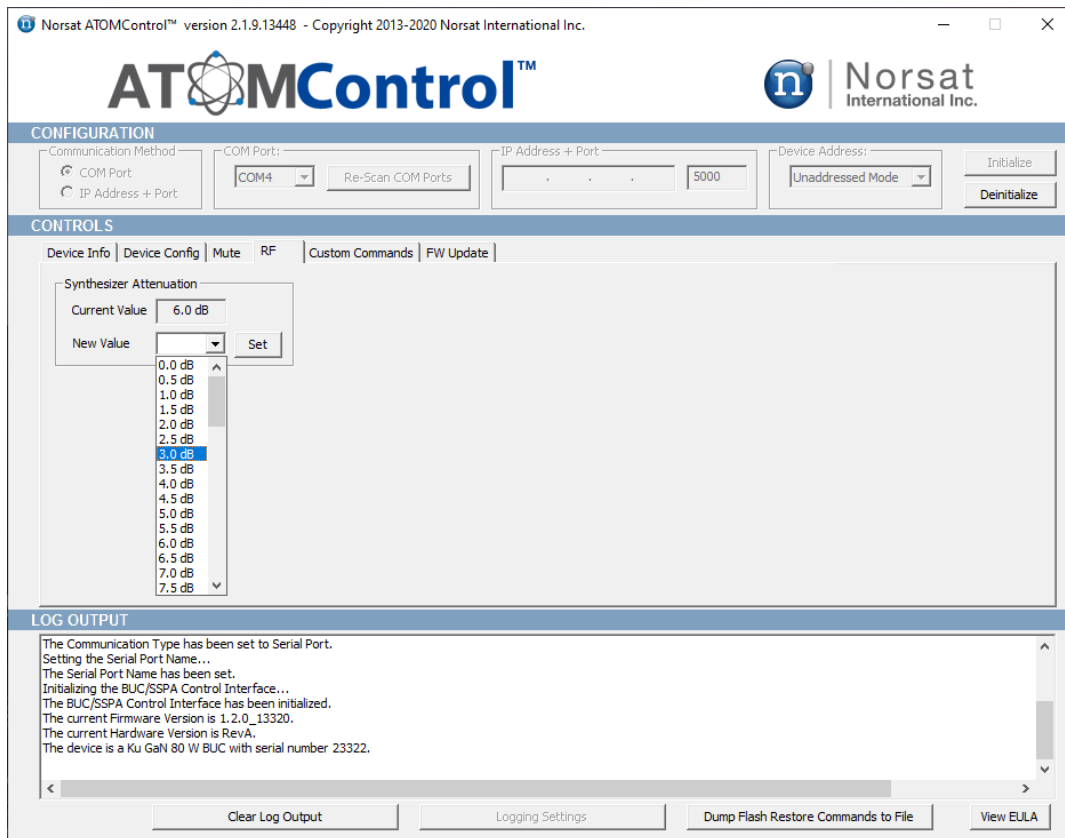

Figure 12: RF Tab Controls

The current attenuation provided by the Digital Attenuator (DAT) will be updated automatically in the **Current DAT Value** field. To change the attenuation value, select a new attenuation from the **New DAT Value** pull-down menu and then click on the **Set** button.

### 3.4 Sending Custom Commands

The Custom Commands tab can be used to communicate with the BUC or SSPA directly using a series of command strings that follow the ATOM Communication Protocol. This protocol that applies to ATOM and Element BUCs and SSPAs.

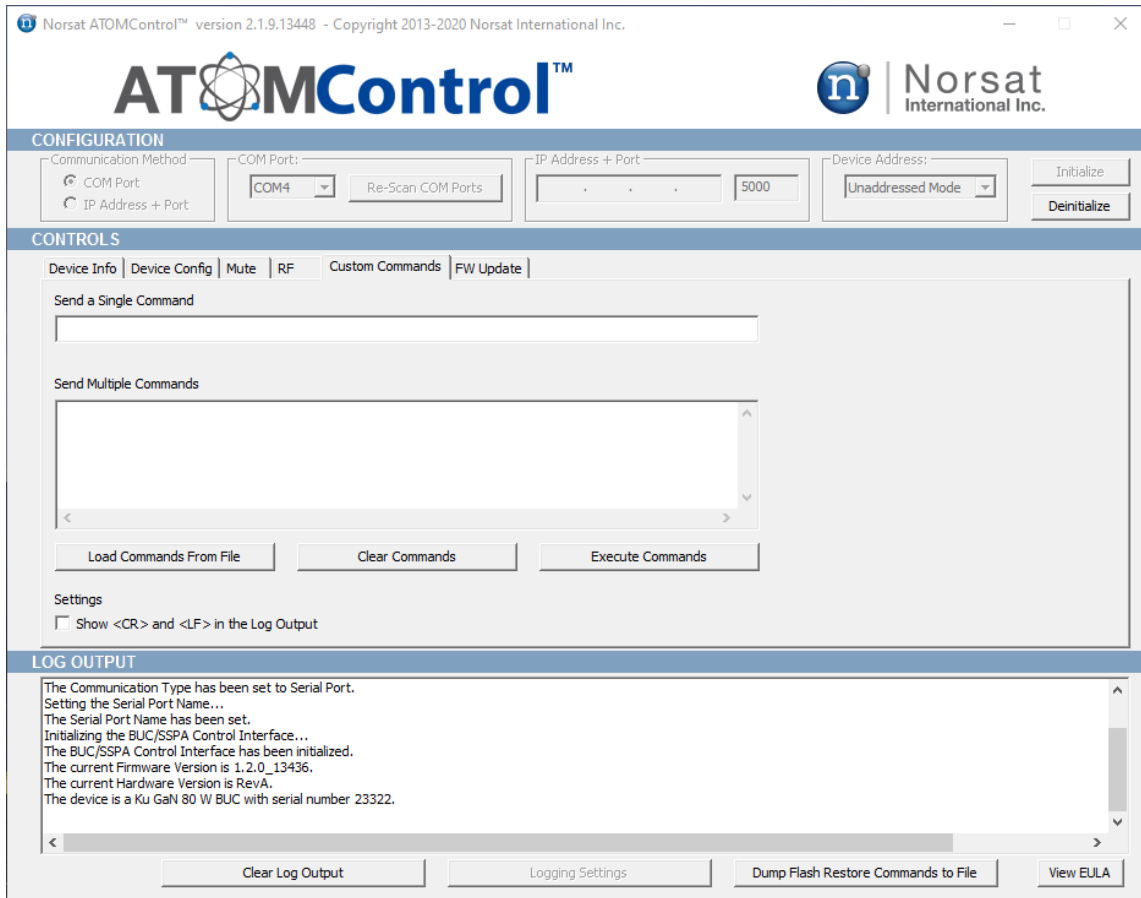

Figure 13: The Custom Commands Tab

ATOM and Element Series BUCs and SSPAs are controlled using character-based command strings sent over a serial interface. ATOMControl provides users with the ability to send command strings to a device and to view the corresponding response string received from the device. A single response string will be generated for each command sent to the device. Improperly-formatted or invalid command strings will produce error response strings. Response strings are typically received immediately after sending the command string, though some response strings may have a short delay.

All command strings follow the same basic format: a Command Name followed by zero or more pairs of Command Parameters and Values. Sample commands include:

```
getident  
  
setmute cmd 1  
  
setmute value 0
```

All response strings also follow a common format: a status string followed by zero or more pairs of Response Parameters and values. Sample response strings (and the commands that generated them) are as follows:

```
getstatus  
ok fault 0 fwdpwr +17.3 revpwr -15.8 temp 42  
  
setmute cmd 1  
ok  
  
bad command  
err "Invalid Command"
```

The response a command may vary depending on the device. Please consult the device's Operator Manual for more details concerning the command strings that can be sent and the expected corresponding response strings.

ATOMControl provides two sets of controls that can be used to send command strings to a BUC or SSPA. The **Send a Single Command** text field allows the user to type in a single command string to be sent to the device. Pressing the Enter key while in this field will send the contents of the field to the device. Pressing the Up or Down Arrow keys while in this field will cycle backwards or forwards through the history of previously-sent command strings.

Multiple commands can be sent one after the other using the **Send Multiple Commands** multi-line text field. Commands may be typed, copied-and-pasted, or loaded into the field from a text file using the **Load Commands From File** button. All text can be removed from the field using the **Clear Commands** button. Pressing the **Execute Commands** button will send each non-blank line in the field to the device.

Command strings that are sent to a BUC or SSPA will be displayed in the Log Output text field, as will the corresponding response string. If the **Show <CR> and <LF> in the Log Output** checkbox is checked, then both the command string and the response string will show the Carriage Return (ASCII 0x0D) and Line Feed (ASCII 0x0A) characters used in the ATOM Communication Protocol. If the checkbox is unchecked, then the Carriage Return and Line Feed characters will be stripped out of the command and response strings, leaving only the content of the outgoing or incoming messages. **Figure 14** and **Figure 15** show sample command and response strings with and without the Carriage Return and Line Feed characters displayed:

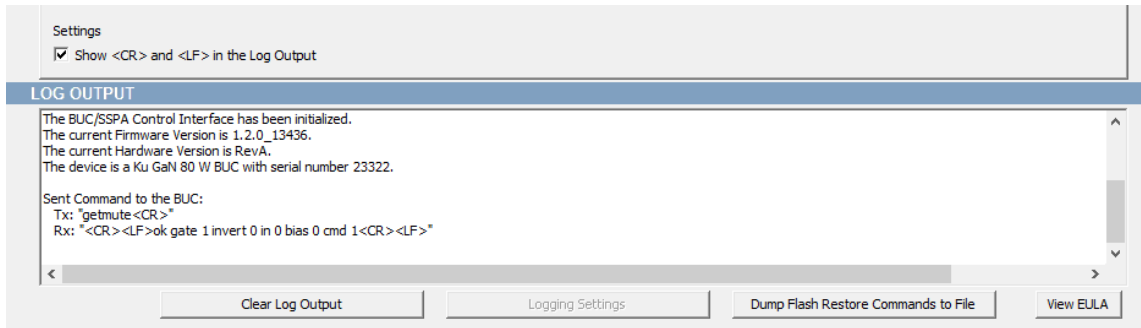

**Figure 14: Command and Response Strings Showing <CR> and <LF>**

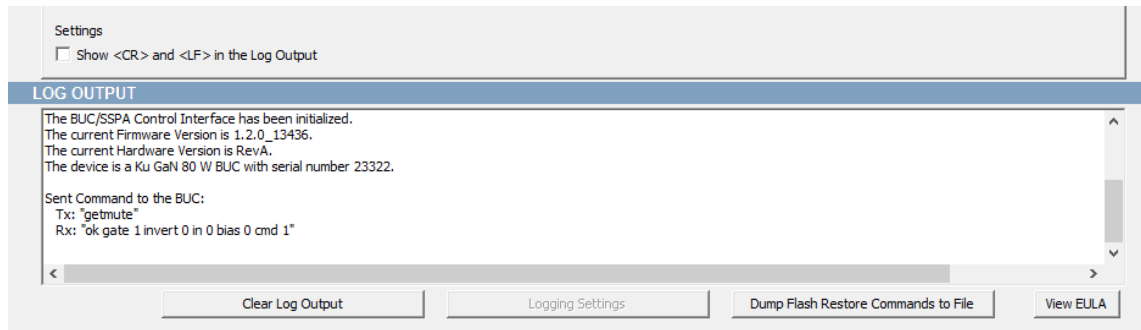

**Figure 15: Command and Response Strings Without <CR> and <LF>**

## 4. Saving and Restoring Settings

---

*This chapter explains how to use ATOMControl to save and restore the system settings of the currently connected ATOM or Element device. This function allows a user to back up the settings for a device to a config file, as well as to restore the device settings from the saved config file.*

ATOMControl includes the ability to preserve the configuration information stored in an ATOM Series device's internal memory. This allows a device to be restored to the backed-up configuration if the device's configuration is changed, or in the unlikely event that something goes wrong with the device's internal memory.

### 4.1 Saving Device Settings

Before backing up a device's configuration settings, ensure that ATOMControl is running and that the program has successfully initiated communication with the ATOM or Element device. Once connected, select the **Dump Flash Restore Commands to File** button to initiate the process. ATOMControl will read all of the configuration settings from the device and write these settings to a configuration file located in the same directory as the ATOMControl program file.

The configuration file name will use the following format:

```
<serial number>_commands.txt
```

Where <serial number> represents the serial number for the device.

For example, a device with serial number 30201 will produce a text file with the name 30201\_commands.txt.

**WARNING:** DO NOT EDIT A CONFIGURATION FILE WITH A TEXT EDITOR OR CHANGE THE CONFIGURATION FILE NAME.

Modifications to the configuration file may result in the inability to restore the device's configuration settings. Invalid configuration settings could also result in damage to the ATOM or Element device.

**Figure 16** shows the **Dump Flash Restore Commands to File** button and the message that is displayed when the configuration settings backup has successfully finished.

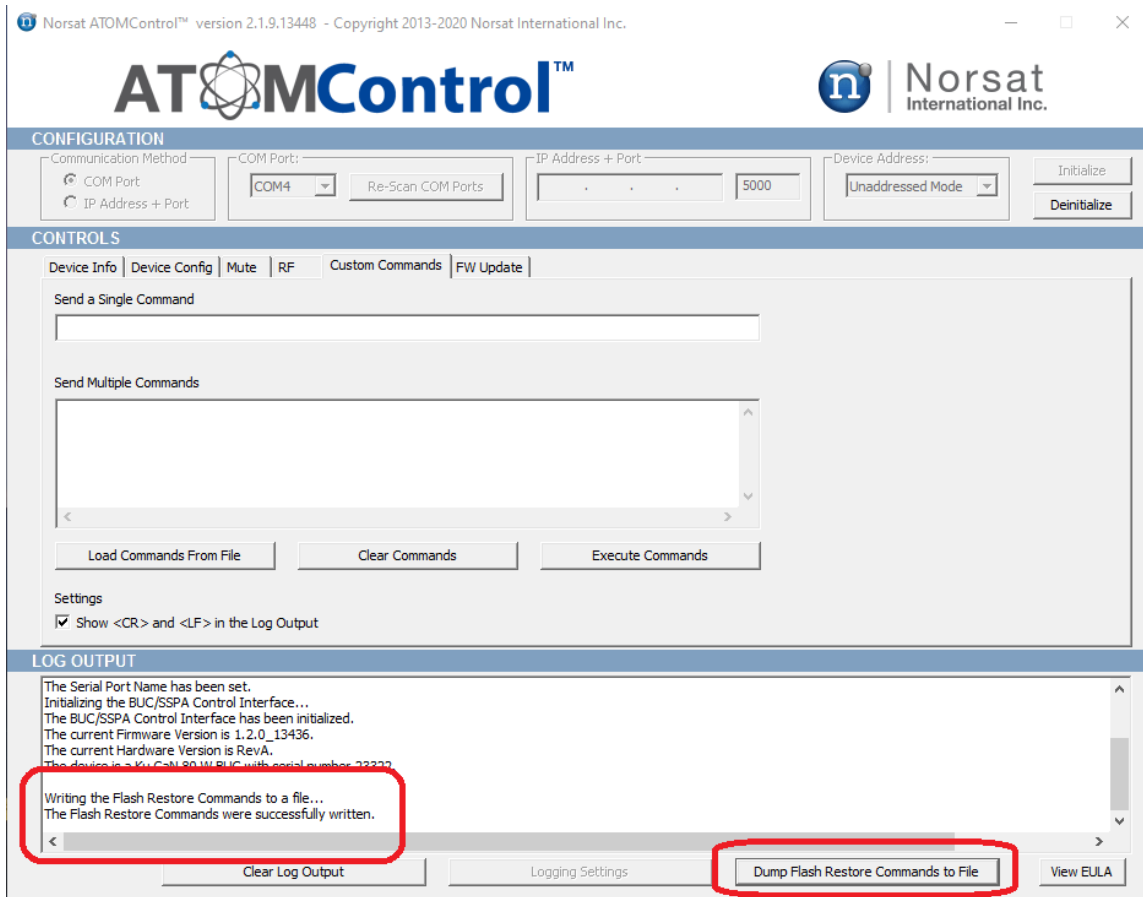
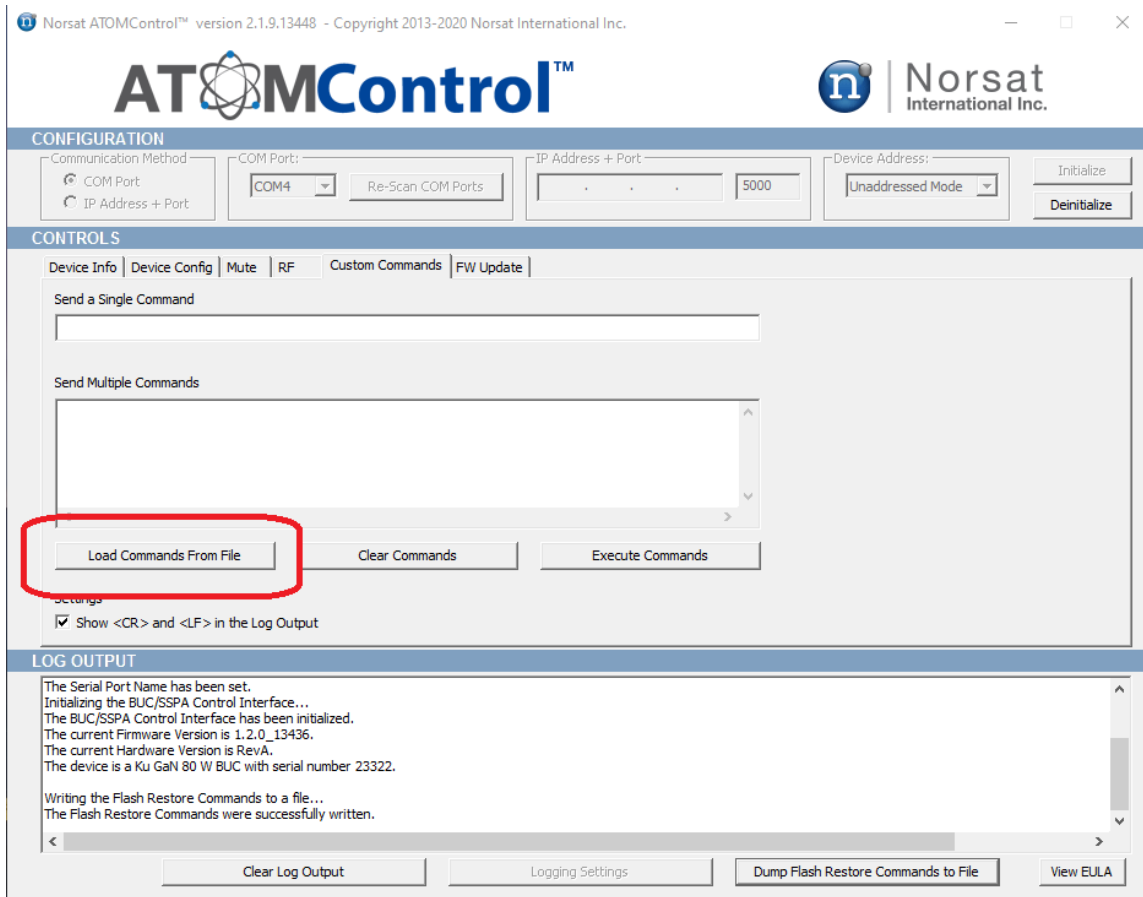

Figure 16: Dump Flash Restore Commands to File Function

## 4.2 Restoring Device Settings

Before restoring a device’s configuration settings, ensure that ATOMControl is running and that the program has successfully initiated communication with the device. Once connected, navigate to the Custom Commands tab and select the **Load Commands from File** button, as shown in **Figure 17** below, to bring up a file selection dialog box. Navigate to the location of the configuration file and select the appropriate file. It is important to ensure that you are selecting a file that corresponds to the serial number for the device. Do not use files intended for other devices, as this may cause damage to the ATOM or Element device. Once the correct file has been selected, press the **Open** button shown in **Figure 18**. This will automatically load the contents of the file into the Send Multiple Commands field. Select the **Execute Commands** button to send the configuration information to the device. Do not disconnect any communication cables or deinitialize the communication interface while this is taking place, as this can result in errors in the device’s configuration and settings. Allow 1 to 2 minutes for the configuration settings to be sent to the device, and then power cycle the device, this will allow the restored configuration settings to take effect.





**Figure 17: Restore Settings from File Function**

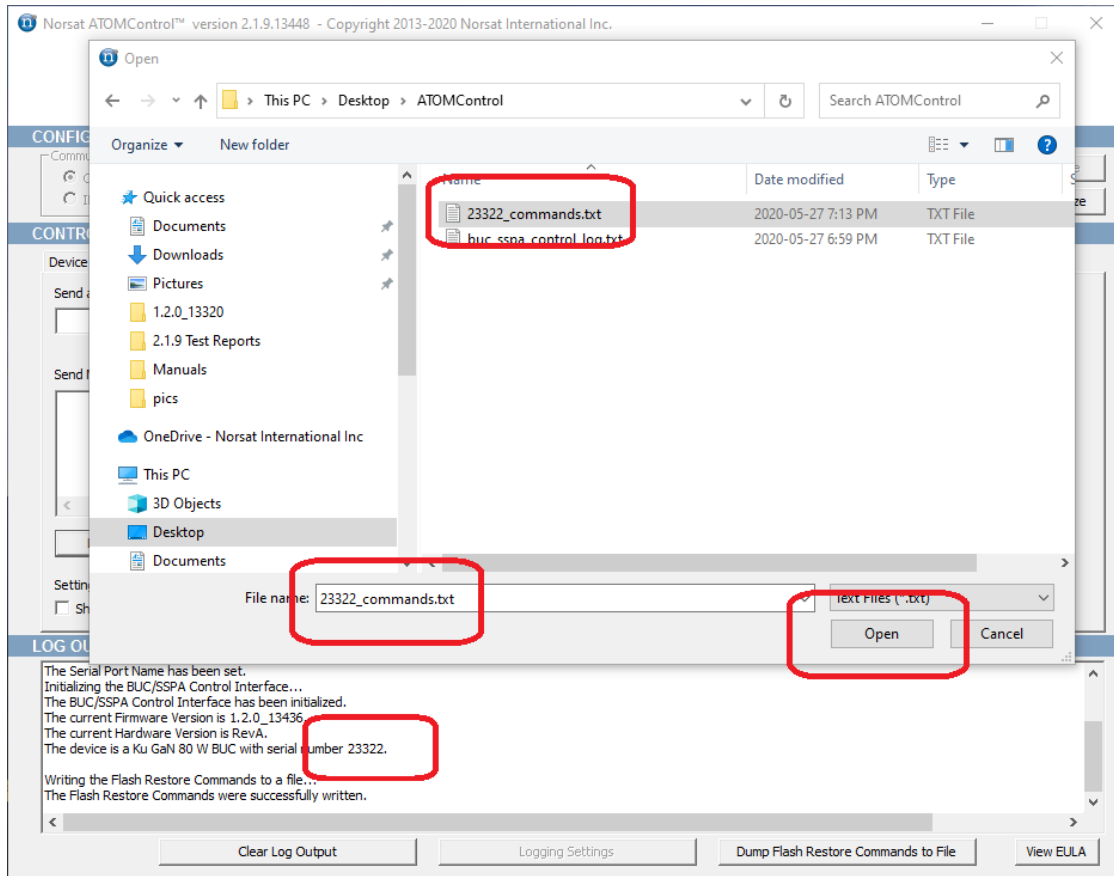

**Figure 18: Restore Settings File Selection Dialog**

**WARNING:** ALWAYS SELECT A CONFIGURATION FILE WITH THE SAME SERIAL NUMBER AS THE CONNECTED ATOM or ELEMENT DEVICE.

Loading the wrong settings on an ATOM or Element device may result in damage to the device or may render it non-functional.

## 5. Firmware Update

---

*This chapter explains how to use ATOMControl to update an ATOM device's firmware for ATOM models that support this feature.*

ATOMControl includes the ability to update the firmware version in ATOM Series devices that have firmware update capability.

### 5.1 Firmware Update Capability

Before updating a device's firmware version, ensure that ATOMControl is running and that the program has successfully initiated communication with the ATOM device. Once connected, ATOMControl displays a FW Update tab only if the ATOM device has firmware update capability.

**Table 7** below lists the ATOM Product Types that support firmware update.

<b>BUC Product Types</b>	<b>SSPA Product Types</b>
Ku G 20 W BUC	Ku G 20 W SSPA
Ku G 40 W BUC	Ku G 40 W SSPA
Ku G 80 W BUC	Ku G 80 W SSPA

**Table 7: Product Types Capable of Firmware Update**

Figure 19 below shows the FW Update tab controls:

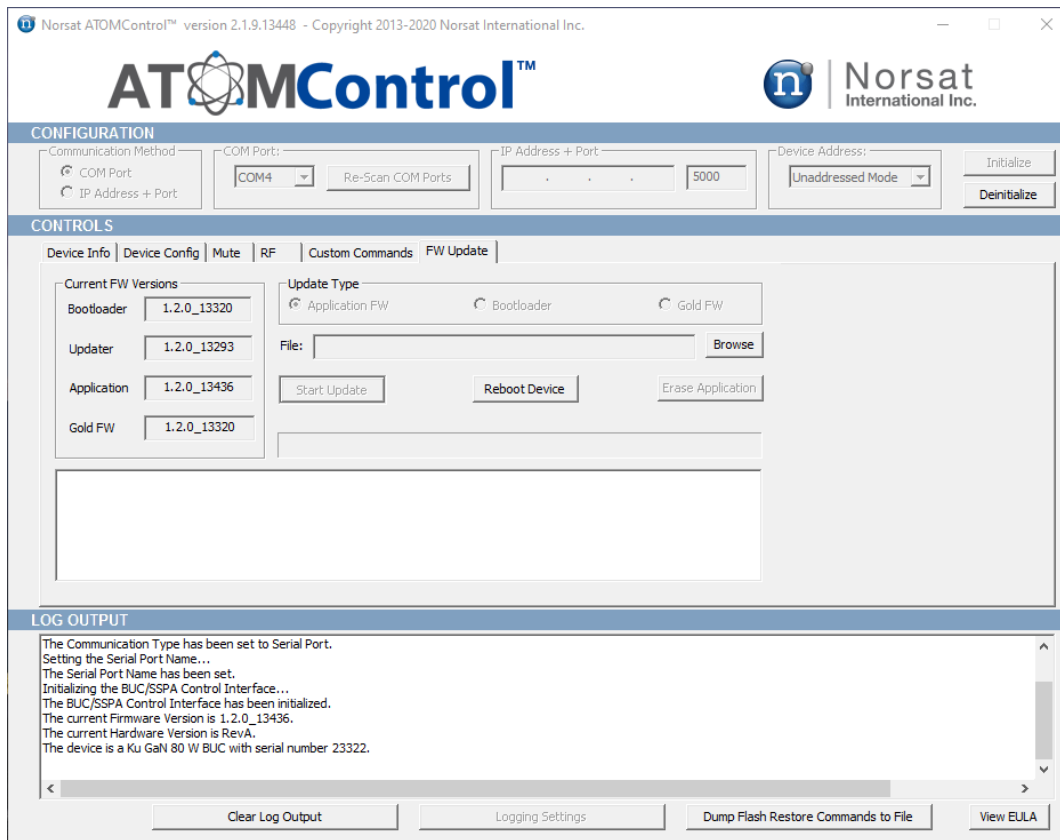

Figure 19: Firmware Update Tab Controls

## 5.2 Backing Up System Settings

Before performing a firmware version update, always backup the ATOM device's system settings as described in the Saving and Restoring Setting section.

## 5.3 Firmware Image File

Contact technical support for availability of new firmware version for your ATOM device and the suitability of performing the update. A firmware image file has the following file naming format.

ATOM\_KUGAN\_FW\_APPL\_<Major.Minor.Revision\_Build>.fwa

- Major – Major version number
- Minor – Minor version number
- Revision – Revision number of version
- Build – Software build number

## 5.4 Performing Firmware Update

The FW Update tab contains controls for performing a firmware update. The various components of the current firmware version will be displayed.

Figure 20 below shows the components of current firmware version:

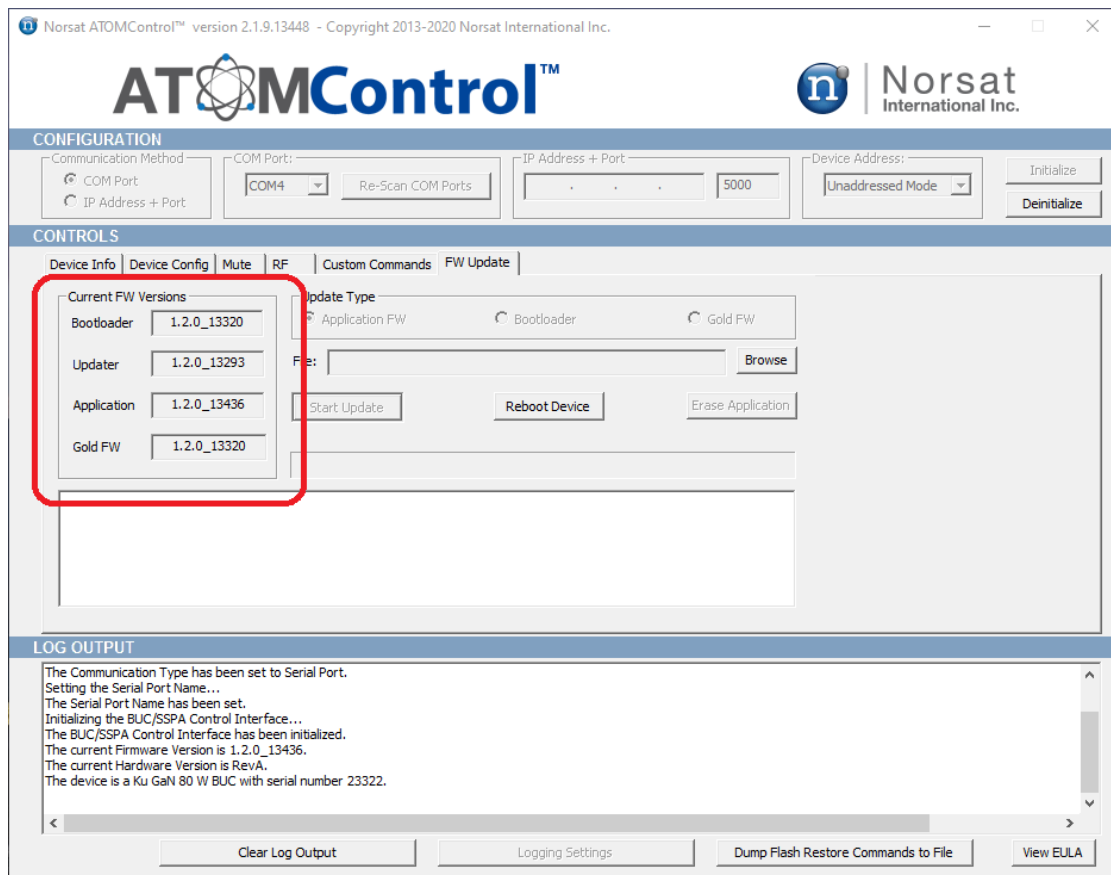

Figure 20: Components of Current Firmware Version

Figure 21 below shows the FW Image Browse function:

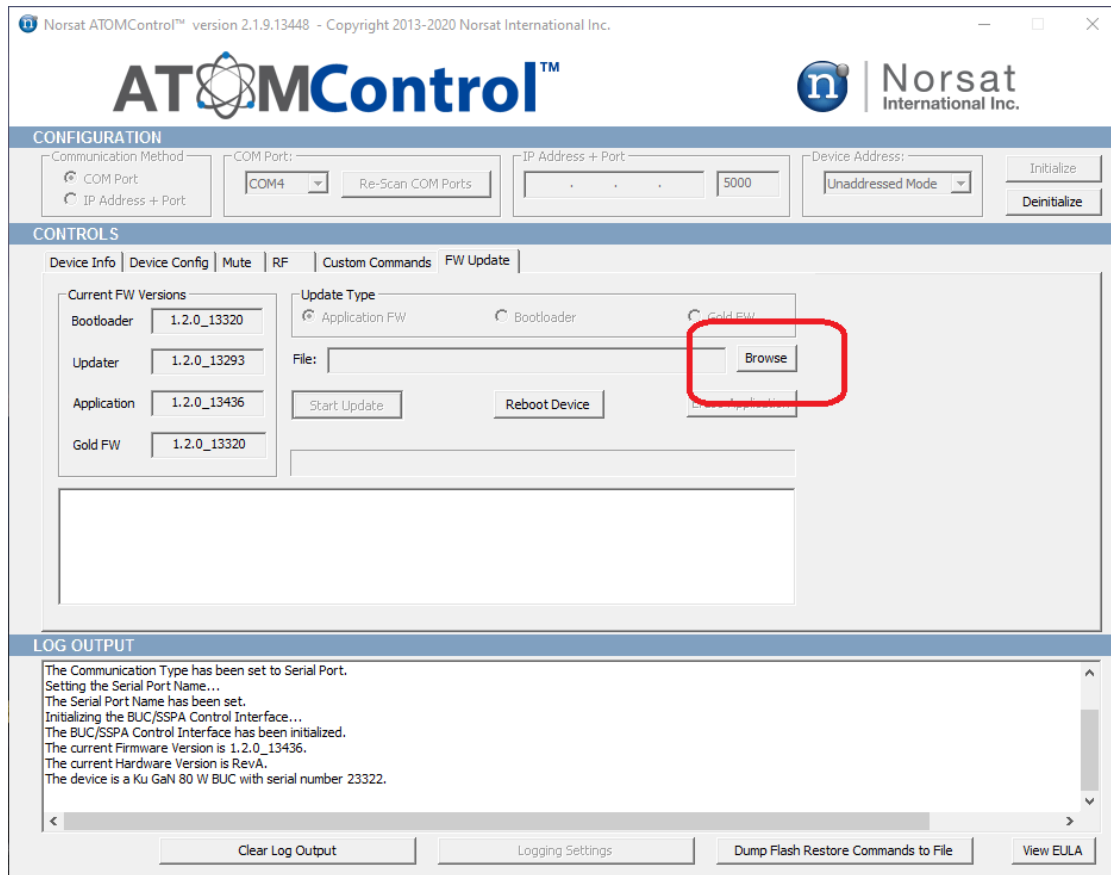
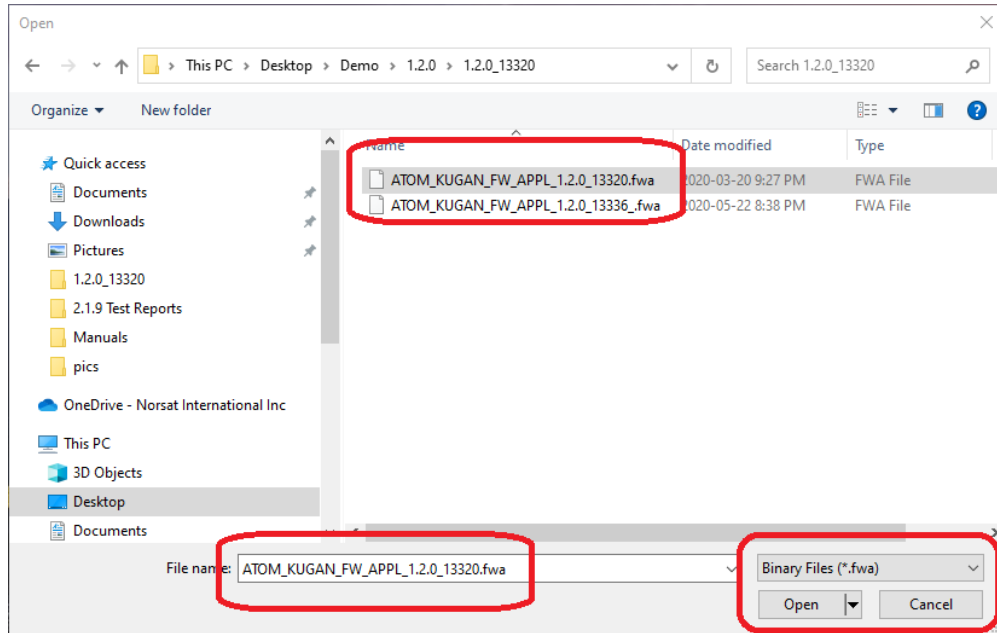

Figure 21: FW Image Browse Function

Click the Browse button to show the Image File Selection Dialog.

**Figure 22** below shows the Image File Selection Dialog:



**Figure 22: Image File Selection Dialog**

Navigate to the location of the firmware image and select the file that will be used to update the ATOM device. Click Open to confirm the file selection.

**Figure 23** below shows the confirmation of the selected firmware image file and the availability of the Start Update function.

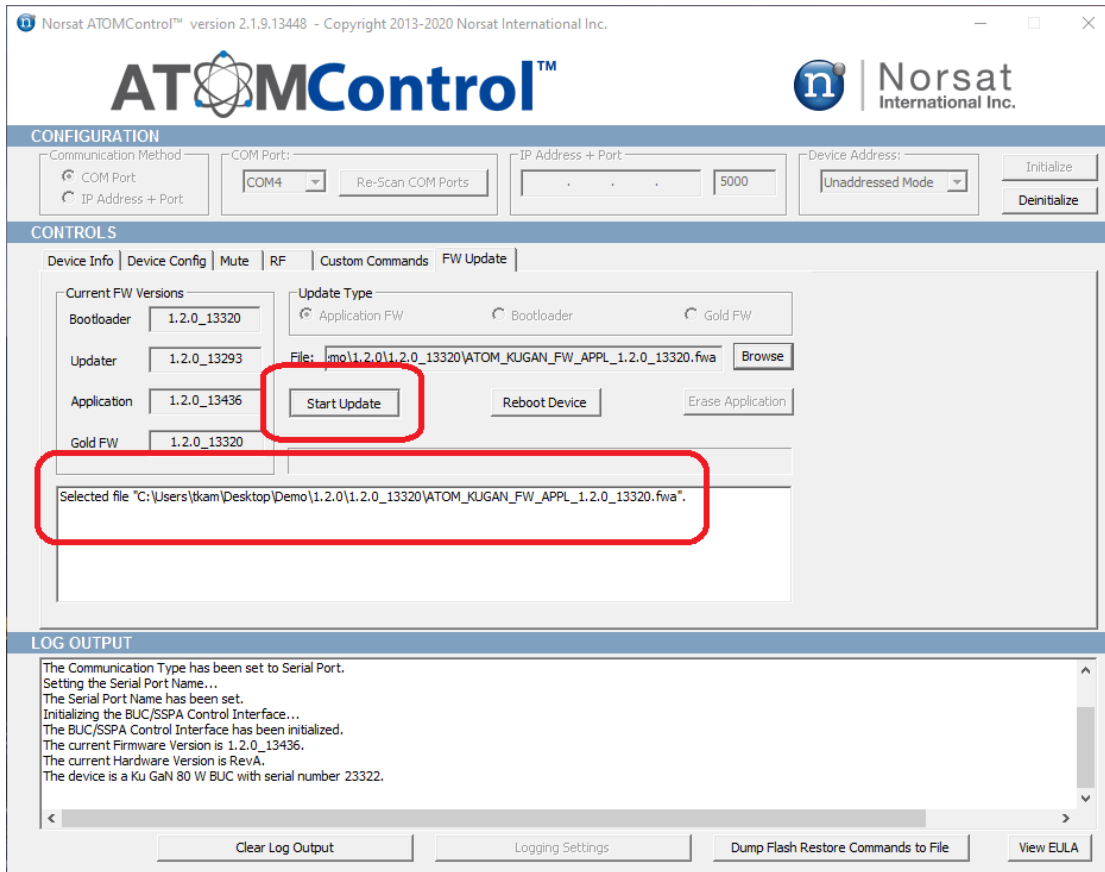
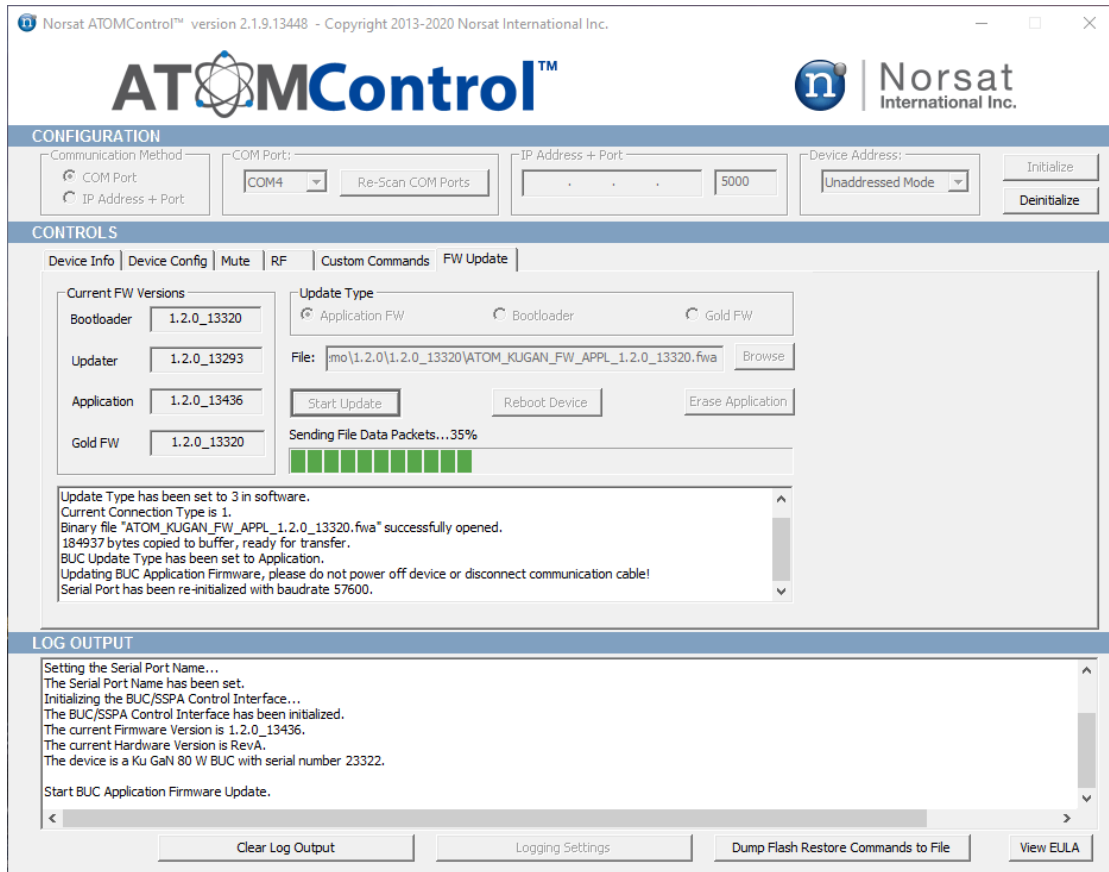

**Figure 23: Image File Confirmation and Start Update Function**

Click the **Start Update** button to start the firmware update process.

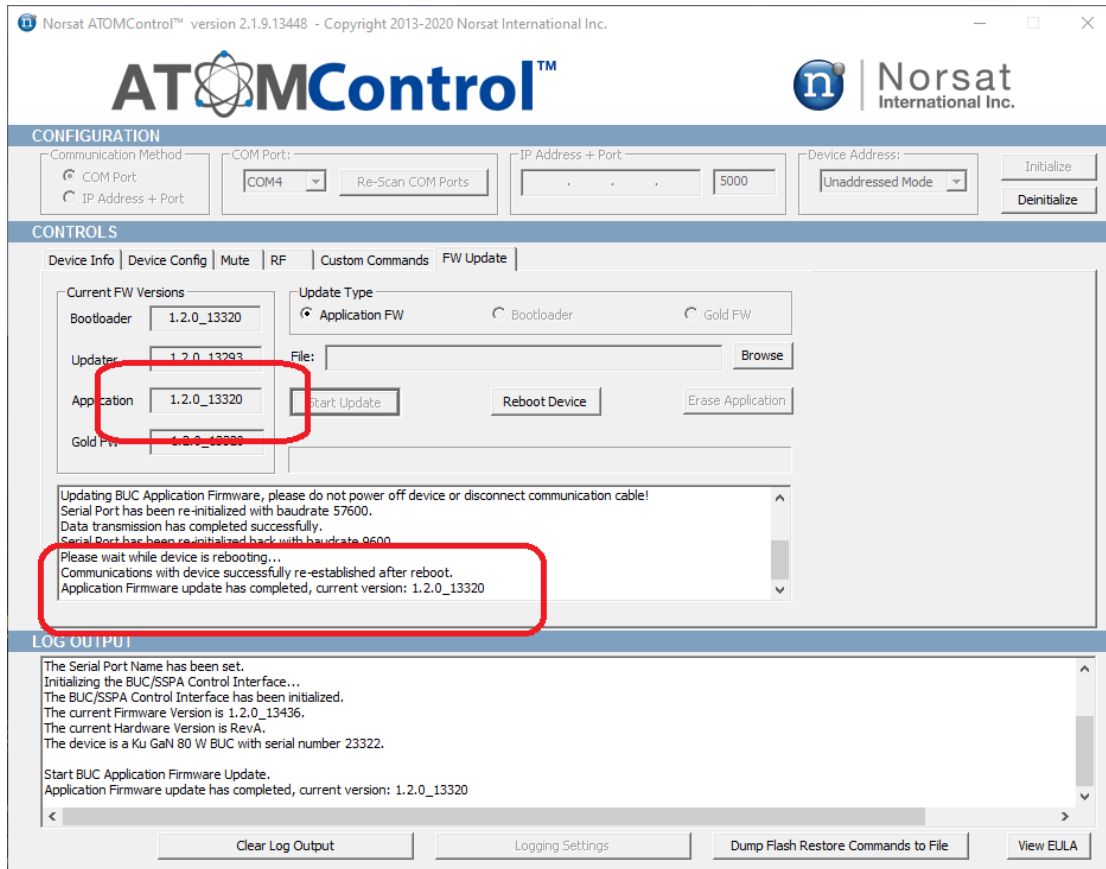

**Figure 24** below shows the progress bar for the firmware update. This process can take up to one minute. Do not switch off the ATOM device while the firmware update is in progress.



**Figure 24: Progress Bar Indicates Firmware Update Progress**

Once complete, the ATOM device will automatically reset and reconnect to ATOMControl. The status will display the new version of firmware that is running on the ATOM device. See **Figure 25** for more information.



**Figure 25: Confirmation of Updated Firmware Version**

## 5.5 Reboot Device Function

The FW Update tab has the ability to Reboot the Device. The Reboot Device function allows the user to warm reboot providing an alternative for power cycling the ATOM unit. When a warm reboot is complete, ATOMControl automatically reconnects to the ATOM device.

Figure 26 below shows the Reboot Device button.

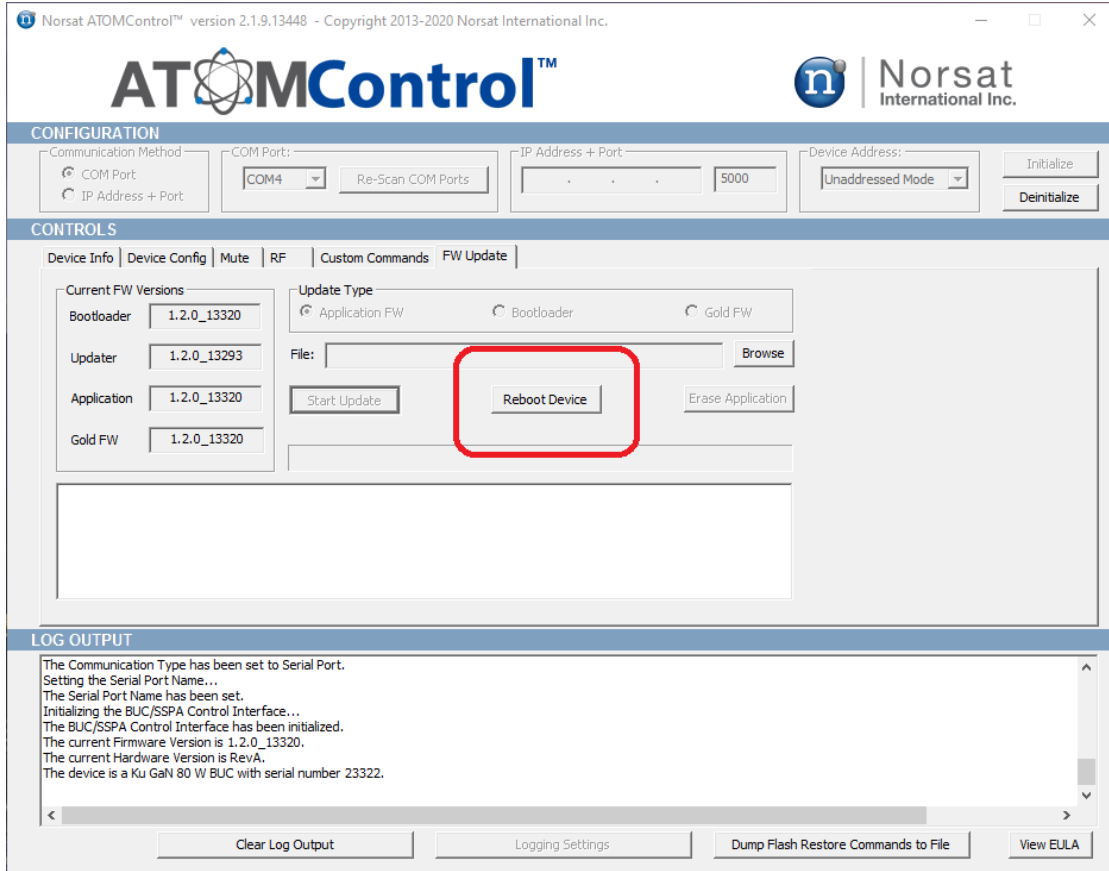

Figure 26: Reboot Device Button



**Norsat**  
International Inc.

## ATOMControl



### ABOUT NORSAT

Norsat International Inc., founded in 1977, is a leading provider of innovative communication solutions that enable the transmission of data, audio and video for remote and challenging applications. Norsat's products and services include customizable satellite components, portable satellite terminals, maritime solutions and satellite networks. The company's products and services are used extensively by telecommunications services providers, emergency services and homeland security agencies, military organizations, health care providers and Fortune 1000 companies.

110 – 4020 Viking Way | Richmond | British Columbia | Canada

V6V 2L4 | [support@norsat.com](mailto:support@norsat.com)

[www.norsat.com](http://www.norsat.com)